







**PICTURE  
COFFEE  
MAP  
of the  
WORLD**







THE LONDON COFFEE HOUSE

NORWAY

SWEDEN  
HEAVY  
COFFEE  
DRINKERS  
HERE

TEA FINDS FAVOR HERE

DENMARK

GERMANY

BACH'S  
COFFEE CANTATA  
1732

TEA RULES HERE

IRELAND

ITALY

THE TURKISH  
COFFEE HOUSE

MOCHA

OMAR AND THE  
MARVELOUS  
COFFEE BIRD

INDIA

PHILIPPINE  
ISLANDS

ABYSSINIA

KALDI AND  
HIS GOATS  
DISCOVER COFFEE

FRENCH  
INDO  
CHINA

KENYA  
COLONY

EAST AFRICAN  
COFFEES

SUMATRA

BORNEO

CELEBES

NEW GUINEA

WEST  
AFRICAN  
COFFEES

JAVA



JAVA COFFEE  
EX-SAILING SHIP



KOLSCHITZKY OPENS THE FIRST  
VIENNA COFFEE HOUSE, 1683



"ALL ABOUT COFFEE"  
COPYRIGHT 1935 BY  
W.H. UKERS, N.Y.







Je ne fay rien  
sans  
**Gayeté**

*(Montaigne, Des livres)*

Ex Libris  
**José Mindlin**



# ALL ABOUT COFFEE



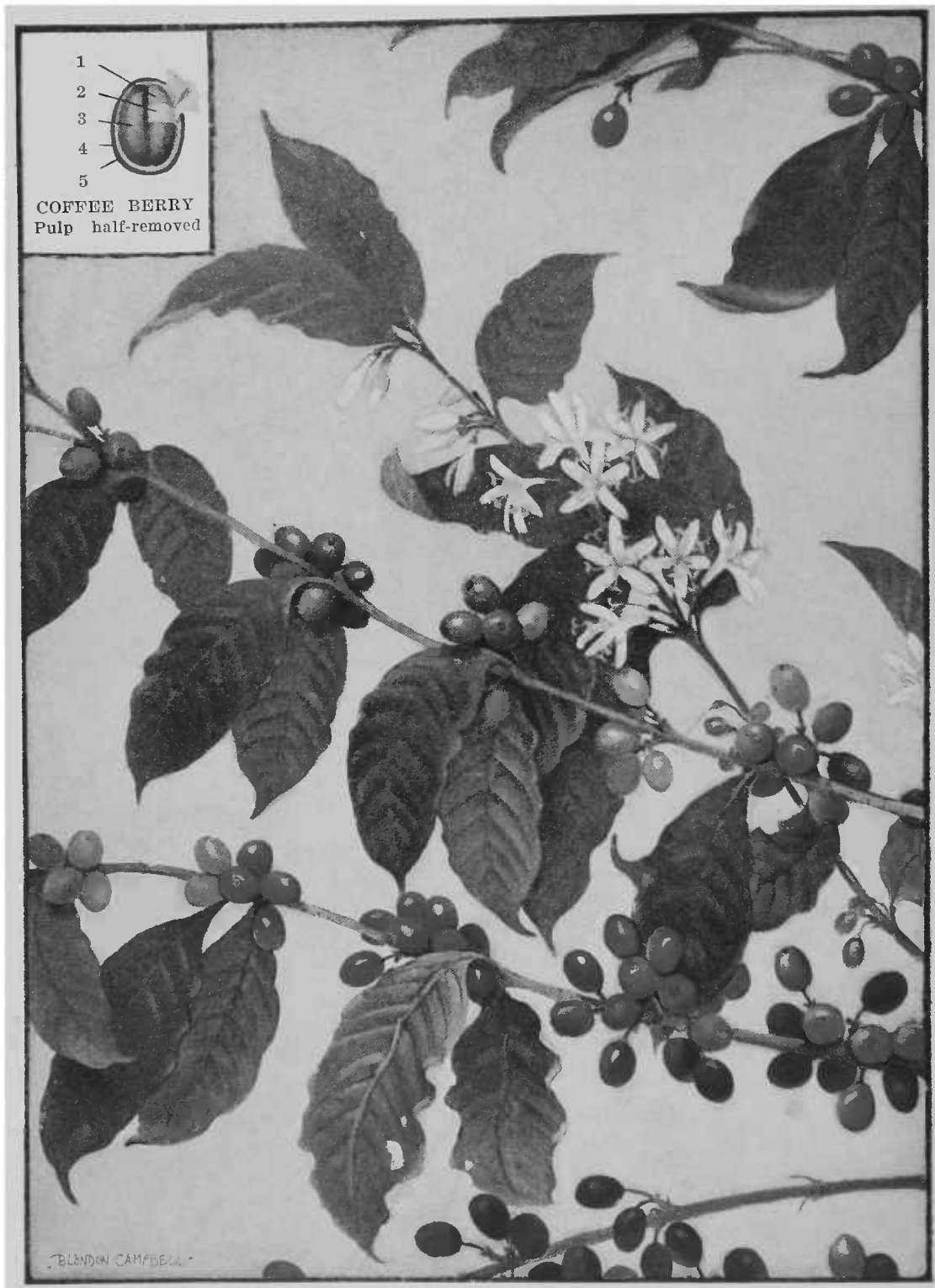
OTHER BOOKS BY THE SAME  
AUTHOR

*All About Tea*  
*Coffee Merchandising*  
*Coffee in a Nutshell*  
*What Everyone Should Know*  
*About Tea*  
*Tea in a Nutshell*

*Little Journey Series of:*  
*Trips to Japan and Formosa*  
*Ceylon*  
*British India*  
*Java and Sumatra*  
*China*  
*Brazil*







### COFFEE BRANCHES, FLOWERS, AND FRUIT

SHOWING THE BERRY IN ITS VARIOUS RIPENING STAGES FROM FLOWER TO CHERRY  
(Inset: 1, green bean; 2, silver skin; 3, parchment; 4, fruit pulp; 5, outer skin.)  
Painted from life by Blendon Campbell

# ALL ABOUT COFFEE

BY

WILLIAM H. UKERS, M.A.

*Second Edition*

NEW YORK

THE TEA & COFFEE TRADE JOURNAL COMPANY

1935



SECOND EDITION  
COPYRIGHT, 1935

*by*

WILLIAM H. UKERS

Copyright under International Copyright Union  
All Rights Reserved under Inter-American Copyright Union

---

*All rights reserved by the author including  
the right to reproduce this book, or any  
part thereof, in any form*

FIRST EDITION COPYRIGHT, 1922

PRINTED IN THE UNITED STATES OF AMERICA  
BY BURR PRINTING HOUSE

iv

**To My Wife**  
**HELEN DE GRAFF UKERS**





## P R E F A C E

**T**HIRTY years ago the author of this work made his first trip abroad to gather material for a book on coffee. Subsequently he spent a year in travel among the coffee-producing countries. After initial surveys, correspondents were appointed to make researches in the principal European libraries and museums; and this phase of the work continued until April, 1922. Simultaneous researches were conducted in American libraries and historical museums up to the time of the return of the final proofs to the printer in June, 1922. The first edition of *All About Coffee* was published in October, 1922.

It required ten years to sort and classify the material for the first edition of the work and four years were consumed in the writing of it. The revision called for in connection with this second edition has extended over a period of eighteen months.

Among the unique features of the book are a Coffee Thesaurus; a Coffee Chronology, containing 562 dates of historical importance; a Complete Reference Table of the Principal Kinds of Coffee Grown in the World; a Coffee Dictionary of 347 definitions; a Coffee Bibliography of over 2,000 authors and titles; and an Index of over 10,000 references.

The most authoritative works on this subject have been Robinson's *The Early History of Coffee Houses in England*, published in London in 1893; and Jardin's *Le Café*, published in Paris in 1895. The author wishes to acknowledge his indebtedness to both for inspiration and guidance. Other works, Arabian, French, English, German, and Italian, dealing with particular phases of the subject, have been laid under contribution; and where this has been done, credit is given by foot-note reference. In all cases where it has been possible to do so, however, statements of historical facts have been verified by independent research. Not a few items have required months of tracing to confirm or to disprove.

There has been no authentic American work on coffee since Hewitt's *Coffee: Its History, Cultivation and Uses*, published in 1872; and Thurber's *Coffee from Plantation to Cup*, published in 1881. Both of these are now out of print, as is also Walsh's *Coffee: Its History, Classification and Description*, published in 1893. Many books on coffee deal with specific phases of the subject and not all have been free from propaganda. *All About Coffee* is the first independent work fully covering all phases and it is intended to appeal to the general reader as well as those directly associated with coffee.

The chapters on The Chemistry of Coffee and The Pharmacology of Coffee have been prepared under the author's direction by Dr. S. C. Prescott, Dean of Science and Head of the Department of Biology and Public Health, Massachusetts Institute of Technology, Cambridge, Mass. There is also included a special contribution on the scientific solution of coffee problems by P. W. Punnett, Ph.D., Research Associate, Teacher's College, Columbia University, New York.

In addition to the more formal acknowledgements elsewhere, the author wishes to thank all those who have lent a hand in the preparation of *All About Coffee*. The work has been made possible by the fine, unselfish cooperation of many in and out of the trade and industry who have assisted in the researches as a scientific contribution to our knowledge of coffee.

New York, October 3, 1935.

## ACKNOWLEDGMENTS

**G**RATEFUL thanks are returned by the author to all individuals, associations, institutions, and firms who have assisted him in the preparation of this work. For literary aid, research courtesies, permissions to quote, reproduce paintings, photographs, etc., and for scientific, technical, and historical data, or for critical revision of trade and technical chapters:

British Museum, Guildhall Museum, and the Coffee Trade Association, London; Bibliothèque Nationale, Paris; Departamento Nacional do Café, Rio de Janeiro; Instituto de Café do Estado de São Paulo, São Paulo, Brazil; Federacion Nacional de Cafeteros de Colombia, Bogota; Coffee Board of Kenya, Nairobi, B. E. Africa; Congressional Library and Smithsonian Institution, Washington; New York Public Library, Metropolitan Museum of Art, and New York Historical Society, New York; Boston Public Library, and Boston Museum of Fine Arts; State Historical Museum, Madison, Wis.; Maine Historical Society, Portland; Chicago Historical Society; New Jersey Historical Society, Newark; Harvard University Library; Essex Institute, Salem Mass.; Peabody Institute, Baltimore.

Charles Cooper, Charles James Jackson, G. J. Lethem, and Naumann, Gepp & Co., London; Heijbroek & Co.'s Handelmaatschappij, N. V. Gebroeders Veth's Handelmaatschappij, and L. P. de Bussy, Amsterdam, Holland; Dr. Armando Vidal, Dr. Eurico Penteado, and Messrs. Helio Lobo and Sebastião Sampaio, Rio de Janeiro; John R. Ernest, Juan Vinas, Costa Rica; Howard F. Boardman, Hartford, Conn.; Andrew L. Winton, Ph.D., Wilton, Conn.; Walter G. Peter, Washington, D. C.; S. O. Blair, John D. Warfield, and B. F. Gump Co., Chicago; R. V. Engelhard and Lee G. Zinsmeister, Louisville; Charles H. Barnes, Medford, Mass.; Gwynne Evans, William Fisher, A. E. Forbes, and Jerome J. Schotten, St. Louis; William B. Harris, East Orange, N. J.; John Cotton Dana, Newark, N. J.; Judge A. T. Clearwater, Kingston, N. Y.; W. H. Harrison and James Heekin, Cincinnati; A. H. Devers, Portland, Ore.; W. James Mahood, Pittsburgh; Lewis Sherman, Milwaukee.

NEW YORK CITY—George Arliss, B. D. Balart, Francis Hill Bigelow, A. L. Burns, Blendon R. Campbell, Walter Chester, Felix Coste, A. J. Dannemiller, A. H. Davies, H. G. Dwight, F. W. Erhard, W. B. Frank, Edward M. Frankel, Ph.D., F. Hulton Frankel, Ph.D., Francis P. Garvan, Fred P. Gordon, R. T. Haines Halsey, Mary P. Hamlin, Richard Hole, Burton Holmes, F. T. Holmes, A. F. Israel, George W. Lawrence, B. A. Livierato, Payson MacKaye, J. A. Medina, Charles Meehan, J. P. Mertens, Gordon Paton, Alex. H. Purcell, Abraham Reamer, S. E. Rosenthal, S. A. Schonbrunn, W. Lee Simmonds, H. H. Snider, C. H. Stewart, George C. Tyler, John Unkles, George W. Vanderhoef, Herbert Wilde, R. C. Wilhelm, Ray Yerkes, John M. Young.

American Can Co., Balzac Bros., Bureau of Coffee Information, Jabez Burns & Sons, Inc., Bush Terminal Co., Furness, Withy & Co., Ltd., Lamport & Holt Line, Cia de Navegacao Lloyd Brasileiro, Macmillan Co., New York Dock Co., Red "D" Line, Chas. Scribner's Sons.

## FOREWORD

### *Some Introductory Remarks on the Lure of Coffee, Its Place in a Rational Dietary, Its Universal Psychological Appeal, Its Use and Abuse*

CIVILIZATION in its onward march has produced only three important non-alcoholic beverages—the extract of the tea plant, the extract of the cocoa bean, and the extract of the coffee bean.

Leaves and beans—these are the vegetable sources of the world's favorite non-alcoholic table-beverages. Of the two, the tea leaves lead in total amount consumed; the coffee beans are second; and the cocoa beans are third. But in international commerce the coffee beans occupy a far more important position than either of the others, being imported into non-producing countries to twice the extent of the tea leaves. All three enjoy a world-wide consumption, although not to the same extent in every nation; but where either the coffee bean or the tea leaf has established itself in a given country, the other gets comparatively little attention, and usually has great difficulty in making any advance. The cocoa bean, on the other hand, has not risen to the position of popular favorite in any important consuming country, and so has not aroused the serious opposition of its two rivals.

For a quick "explosion" men still have recourse to alcoholic drinks, pseudo stimulants, which often are narcotics and depressants. Tea, coffee, and cocoa are true stimulants to the heart, nervous system, and kidneys; coffee is more stimulating to the brain, cocoa to the kidneys, while tea occupies a happy position between the two, being mildly stimulating to most of our bodily functions. These three beverages must ever be associated with rational living, with greater comfort, and with better cheer.

Coffee is universal in its appeal. All nations do it homage. It has become recognized as a human necessity. It is no longer a luxury or an indulgence; it is a corollary of human energy and human efficiency. People love coffee because of its two-fold effect—the pleasurable sensation and the increased efficiency it produces.

Coffee has an important place in the rational dietary of all the civilized peoples of earth. It is a democratic beverage. Not only is it the drink of fashionable society, but it is also a favorite beverage of the men and women who do the world's work, whether they toil with brain or brawn. It has been acclaimed "the most grateful lubricant known to the human machine," and "the most delightful taste in all nature."

No "food drink" has ever encountered so much opposition as coffee. Given to the world by the church and dignified by the medical profession, nevertheless it has had to suffer from religious superstition and medical prejudice. During the thousand years of its development it has experienced fierce political opposition, stupid fiscal restrictions, unjust taxes, irksome duties; but, surviving all of these, it has triumphantly moved on to a foremost place in the catalog of popular beverages.

But coffee is something more than a beverage. It is one of the world's greatest adjuvant foods. There are other auxiliary foods, but none that excels it for palatability and comforting effects, the psychology of which is to be found in its unique flavor and aroma.

Men and women drink coffee because it adds to their sense of well-being. It not only smells good and tastes good to all mankind, heathen or civilized, but all respond to its wonderful stimulating properties. The chief factors in coffee goodness are the caf-



feine content and the caffeol. Caffeine supplies the principal stimulant. It increases the capacity for muscular and mental work without harmful re-action. The caffeol supplies the flavor and the aroma—that indescribable Oriental fragrance that woos us through the nostrils, forming one of the principal elements that make up the lure of coffee. There are several other constituents, including certain innocuous so-called caffetannic acids, that, in combination with the caffeol, give the beverage its rare gustatory appeal.

The year 1919 awarded coffee one of its brightest honors. An American general said that coffee shared with bread and bacon the distinction of being one of the three nutritive essentials that helped win the World War for the Allies.

Like all good things in life, the drinking of coffee may be abused. Indeed, those having an idiosyncratic susceptibility to alkaloids should be temperate in the use of tea, coffee, or cocoa. In every high-tensioned country there is likely to be a small number of people who, because of certain individual characteristics, can not drink coffee at all. These belong to the abnormal minority of the human family. Some people can not eat strawberries; but that would not be a valid reason for a general condemnation of strawberries. One may be poisoned, said the late Thomas A. Edison, from too much food. Horace Fletcher was certain that over-feeding causes all our ills. Over-indulgence in meat is likely to spell trouble for the strongest of us. Coffee is, perhaps, less often abused than wrongly accused. It all depends. A little more tolerance!

Trading upon the credulity of the hypochondriac and the caffeine-sensitive, in recent years there has appeared in America and abroad a curious collection of so-called coffee substitutes. They are "neither fish nor flesh, nor good red herring." Most of them have been shown by official government analyses to be sadly deficient in food value—their only alleged virtue. One of the attackers of the national beverage bewailed the fact that no palatable hot drink had been found to take the place of coffee. The reason is not hard to find. There can be no substitute for coffee. The late Dr. Harvey W. Wiley ably summed up the matter by saying, "A substitute should be able to perform the functions of its principal. A substitute to a war must be able to fight. A bounty-jumper is not a substitute."

It has been the aim of the author to tell the whole coffee story for the general reader, yet with the technical accuracy that will make it valuable to the trade. The book is designed to be a work of useful reference covering all the salient points of coffee's origin, cultivation, preparation, and development, its place in the world's commerce and in a rational dietary.

Good coffee, carefully roasted and properly brewed, produces a natural beverage that, for tonic effect, can not be surpassed, even by its rivals, tea and cocoa. Here is a drink that ninety-seven per cent of individuals find harmless, wholesome, and without which life would be drab indeed—a pure, safe, and healthful stimulant compounded in nature's own laboratory, and one of the chief joys of life.



# SCHEME OF CONTENTS

CHAPTER	PAGES
The Evolution of a Cup of Coffee .....	xii
<b>BOOK I</b>	
<b>HISTORICAL</b>	
I—History of Coffee Propagation .....	1-5
II—Early History of Coffee Drinking .....	6-19
III—Introduction of Coffee into Western Europe .....	20-26
IV—Beginnings of Coffee in France .....	27-30
V—Introduction of Coffee into England .....	31-38
VI—Introduction of Coffee into Holland and Scandinavia .....	39-40
VII—Introduction of Coffee into Germany .....	41-43
VIII—Telling How Coffee Came to Vienna .....	44-48
IX—The Coffee Houses of Old London .....	49-85
X—History of the Early Parisian Coffee Houses ..	86-100
XI—Introduction of Coffee into North America .....	101-109
XII—History of Coffee in Old New York .....	110-120
XIII—Coffee Houses of Old Philadelphia .....	121-126
<b>BOOK II</b>	
<b>TECHNICAL</b>	
XIV—The Commercial Coffees of the World .....	129-131
XV—Cultivation and Preparation of Coffee .....	132-147
XVI—Cultivation and Preparation in Brazil .....	148-159
XVII—Cultivation and Preparation in Colombia .....	160-167
XVIII—Cultivation and Preparation in Other Countries ..	168-197
XIX—Green and Roasted Coffee Characteristics .....	198-232
XX—Factory Preparation of Roasted Coffee .....	233-262
<b>BOOK III</b>	
<b>SCIENTIFIC</b>	
XXI—The Etymology of Coffee .....	265-267
XXII—The Botany of the Coffee Plant .....	268-285
XXIII—The Microscopy of the Coffee Fruit .....	286-291
XXIV—The Chemistry of the Coffee Bean .....	292-305
XXV—The Pharmacology of the Coffee Drink .....	306-320
<b>BOOK IV</b>	
<b>COMMERCIAL</b>	
XXVI—How Green Coffees Are Bought and Sold .....	323-370
XXVII—Wholesale Merchandising of Coffee .....	371-381
XXVIII—Retail Merchandising of Coffee .....	382-397
XXIX—History of the Coffee Trade of the United States ..	398-409
XXX—Development of the Green and Roasted Coffee Busi- ness in the United States .....	410-446
XXXI—Some Big Men and Notable Achievements .....	447-467
XXXII—A Short History of Coffee Advertising .....	468-497
XXXIII—The Production and Consumption of Coffee ..	498-534
<b>BOOK V</b>	
<b>SOCIAL</b>	
XXXIV—World's Coffee Manners and Customs .....	537-574
XXXV—The Evolution of Coffee Apparatus .....	575-622
XXXVI—Preparation of the Beverage .....	623-658
<b>BOOK VI</b>	
<b>ARTISTIC</b>	
XXXVII—A History of Coffee in Literature .....	660-703
XXXVIII—Coffee in Relation to the Fine Arts .....	704-732
<b>APPENDIX—A Chronology of Coffee .....</b>	<b>733-744</b>
A Dictionary of Coffee .....	745-752
A Coffee Bibliography .....	753-788
A Coffee Thesaurus .....	789
Index .....	790-818



## EVOLUTION OF A CUP OF COFFEE

*Showing the various steps through which  
the bean passes from plantation to cup*

- 1 Planting the seed in nursery
- 2 Transplanting into rows
- 3 Cultivating and pruning
- 4 Picking the cherries
- 5 Pulping
- 6 Fermenting
- 7 Washing
- 8 Drying in the parchment
- 9 Hulling
- 10 Polishing
- 11 Grading
- 12 Transporting to the seaport
- 13 Buying and selling for export
- 14 Transshipment overseas
- 15 Buying and selling at wholesale
- 16 Shipment to the point of manufacture
- 17 Separating
- 18 Milling
- 19 Mixing or blending
- 20 Roasting
- 21 Cooling and stoning
- 22 Buying and selling at retail
- 23 Grinding
- 24 Making the beverage

**BOOK I**  
**HISTORICAL ASPECTS**



THE FAIRY BEAUTY OF A COFFEE TREE IN FLOWER



## CHAPTER I

### HISTORY OF COFFEE PROPAGATION

A BRIEF ACCOUNT OF THE CULTIVATION OF THE COFFEE PLANT IN THE OLD WORLD AND ITS INTRODUCTION INTO THE NEW—THE ROMANTIC STORY OF THE FIRST SUCCESSFUL ATTEMPT TO TRANSPORT COFFEE PLANTS TO THE ANTILLES BY CAPTAIN GABRIEL MATHIEU DE CLIEU IN 1723—CONTEMPORARY NOTICES OF DE CLIEU'S ACHIEVEMENT

THE history of the propagation of the coffee plant is closely interwoven with that of the early history of coffee drinking, but for the purposes of this chapter we shall consider only the story of the inception and growth of the cultivation of the coffee tree, or shrub, bearing the seeds, or berries, from which the drink, coffee, is made.

Careful research discloses that the coffee plant is indigenous to Abyssinia, and probably Arabia, whence its cultivation spread throughout the tropics. The first reliable mention of the properties and uses of the plant is by an Arabian physician toward the close of the ninth century of the Christian era, and it is reasonable to suppose that before that time the plant was found growing wild in Abyssinia and perhaps in Arabia. If it be true, as Ludolphus writes,<sup>1</sup> that the Abyssinians came out of Arabia into Ethiopia in the early ages, it is possible that they may have brought the coffee tree with them; but the Arabians must still be given the credit for discovering and promoting the use of the beverage, and also for promoting the propagation of the plant, even if they found it in Abyssinia and brought it to Yemen.

Some authorities believe that the first cultivation of coffee in Yemen dates back to A. D. 575, when the Persian invasion put an end to the Ethiopian rule of the negus Caleb, who conquered the country in 525.

Certainly the discovery of the beverage resulted in the cultivation of the plant in

Abyssinia and in Arabia; but its progress was slow until the 15th and 16th centuries, when it appears as intensively carried on in the Yemen district of Arabia. The Arabians were jealous of their new found and lucrative industry, and for a time successfully prevented its spread to other countries by not permitting any of the precious berries to leave the country unless they had first been steeped in boiling water or parched, so as to destroy their powers of germination. It may be that many of the early failures successfully to introduce the cultivation of the coffee plant into other lands was due also to the fact, discovered later, that the seeds soon lose their germinating power.

However, it was not possible to watch every avenue of transport, with thousands of pilgrims journeying to and from Mecca every year; and so there would appear to be some reason to credit the Indian tradition concerning the introduction of coffee cultivation into southern India by Baba Budan, a Moslem pilgrim, as early as 1600, although a better authority gives the date as 1695. Indian tradition relates that Baba Budan planted his seeds near the hut he built for himself at Chickmaglur in the mountains of Mysore, where, only a few years since, the writer found the descendants of these first plants growing under the shade of the centuries-old original jungle trees. The greater part of the plants cultivated by the natives of Coorg and Mysore appear to have come from the Baba Budan importation. It was not until 1840 that the English began the cultivation of coffee in India. The

<sup>1</sup> La Roque, Jean. *Voyage de l'Arabie Heureuse*. Paris, 1716.

plantations extend now from the extreme north of Mysore to Tuticorin.

In the latter part of the 16th century, German, Italian, and Dutch botanists and travelers brought back from the Levant considerable information regarding the new plant and the beverage. In 1614 enterprising Dutch traders began to examine into the possibilities of coffee cultivation and coffee trading. In 1616 a coffee plant was successfully transported from Mocha to Holland. In 1658 the Dutch started the cultivation of coffee in Ceylon, although the Arabs are said to have brought the plant to the island prior to 1505. In 1670 an attempt was made to cultivate coffee on European soil at Dijon, France, but the result was a failure.

In 1696, at the instigation of Nicolaas Witsen, then burgomaster of Amsterdam, Adrian Van Ommen, commander at Malabar, India, caused to be shipped from Kananur, Malabar, to Java, the first coffee plants introduced into that island. They were grown from seed of the *Coffea arabica* brought to Malabar from Arabia. They were planted by Governor-General Willem Van Outshoorn on the Kedawoeng estate near Batavia, but were subsequently lost by earthquake and flood. In 1699 Henricus Zwaardecroon imported some slips, or cuttings, of coffee trees from Malabar into Java. These were more successful, and became the progenitors of all the coffees of the Netherlands Indies. The Dutch were then taking the lead in the propagation of the coffee plant.

In 1706 the first samples of Java coffee, and a coffee plant grown in Java, were received at the Amsterdam botanical gardens. Many plants were afterward propagated from the seeds produced in the Amsterdam gardens, and these were distributed to some of the best known botanical gardens and private conservatories in Europe.

While the Dutch were extending the cultivation of the plant to Sumatra, the Celebes, Timor, Bali, and other islands of the Netherlands Indies, the French were seeking to introduce coffee cultivation into their colonies. Several attempts were made to transfer young plants from the Amsterdam botanical gardens to the botanical gardens at Paris; but all were failures.

In 1714, however, as a result of negotiations entered into between the French government and the municipality of Amsterdam, a young and vigorous plant about five

feet tall was sent to Louis XIV at the chateau of Marly by the burgomaster of Amsterdam. The day following, it was transferred to the Jardin des Plantes at Paris, where it was received with appropriate ceremonies by Antoine de Jussieu, professor of botany in charge. This tree was destined to be the progenitor of most of the coffees of the French colonies, as well as of those of South America, Central America, and Mexico.

#### *The Romance of Captain Gabriel de Clieu*

Two unsuccessful attempts were made to transport to the Antilles plants grown from the seed of the tree presented to Louis XIV; but the honor of eventual success was won by a young Norman gentleman, Gabriel Mathieu de Clieu, a naval officer, serving at the time as captain of infantry at Martinique. The story of de Clieu's achievement is the most romantic chapter in the history of the propagation of the coffee plant.

His personal affairs calling him to France, de Clieu conceived the idea of utilizing the return voyage to introduce coffee cultivation into Martinique. His first difficulty lay in obtaining several of the plants then being cultivated in Paris, a difficulty at last overcome through the instrumentality of M. de Chirac, royal physician, or, according to a letter written by de Clieu himself, through the kindly offices of a lady of quality to whom de Chirac could give no refusal. The plants selected were kept at Rochefort by M. Bégon, commissary of the department, until the departure of de Clieu for Martinique. Concerning the exact date of de Clieu's arrival at Martinique with the coffee plant, or plants, there is much conflict of opinion. Some authorities give the date as 1720, others 1723. Jardin<sup>2</sup> suggests that the discrepancy in dates may arise from de Clieu, with praiseworthy perseverance, having made the voyage twice. The first time, according to Jardin, the plants perished; but the second time de Clieu had planted the seeds when leaving France and these survived, "due, they say, to his having given of his scanty ration of water to moisten them." No reference to a preceding voyage, however, is made by de Clieu in his own account, given in a letter written to the *Année Littéraire* in 1774.<sup>3</sup> There is

<sup>2</sup> Jardin, Édelestan. *Le Caféier et le Café*. Paris, 1895 (p. 102).

<sup>3</sup> *Année, Littéraire*. Paris, 1774 (vol. vi: p. 217).

also a difference of opinion as to whether de Clieu arrived with one or three plants. He himself says "one" in the above-mentioned letter.

According to the most trustworthy data, de Clieu embarked at Nantes, 1723.<sup>4</sup> He had installed his precious plant in a box covered with a glass frame in order to absorb the rays of the sun and thus better to retain the stored-up heat for cloudy



CAPTAIN DE CLIEU SHARES HIS DRINKING WATER WITH THE COFFEE PLANT HE IS CARRYING TO MARTINIQUE

days. Among the passengers one man, envious of the young officer, did all in his power to wrest from him the glory of success. Fortunately his dastardly attempt failed of its intended effect.

"It is useless," writes de Clieu in his letter to the *Année Littéraire*, "to recount in detail the infinite care that I was obliged

<sup>4</sup>Franklin, Alfred. *La Vie Privée d'Autrefois*. Paris, 1893.

to bestow upon this delicate plant during a long voyage, and the difficulties I had in saving it from the hands of a man who, basely jealous of the joy I was about to taste through being of service to my country, and being unable to get this coffee plant away from me, tore off a branch."

The vessel carrying de Clieu was a merchantman, and many were the trials that beset passengers and crew. Narrowly escaping capture by a corsair of Tunis, menaced by a violent tempest that threatened to annihilate them, they finally encountered a calm that proved more appalling than either. The supply of drinking water was well nigh exhausted, and what was left was rationed for the remainder of the voyage.

"Water was lacking to such an extent," says de Clieu, "that for more than a month I was obliged to share the scanty ration of it assigned to me with this my coffee plant upon which my happiest hopes were founded and which was the source of my delight. It needed such succor the more in that it was extremely backward, being no larger than the slip of a pink." Many stories have been written and verses sung recording and glorifying this generous sacrifice that has given luster to the name of de Clieu.

Arrived in Martinique, de Clieu planted his precious slip on his estate in Prêcheur, one of the cantons of the island; where, says Raynal, "it multiplied with extraordinary rapidity and success." From the seedlings of this plant came most of the coffee trees of the Antilles. The first harvest was gathered in 1726.

De Clieu himself describes his arrival as follows:

Arriving at home my first care was to set out my plant with great attention in the part of my garden most favorable to its growth. Although keeping it in view, I feared many times that it would be taken from me; and I was at last obliged to surround it with thorn bushes and to establish a guard about it until it arrived at maturity. . . . this precious plant which had become still more dear to me for the dangers it had run and the cares it had cost me.

Thus the little stranger thrived in a distant land, guarded day and night by faithful slaves. So tiny a plant to produce in the end all the rich estates of the West India islands and the regions bordering on the Gulf of Mexico! What luxuries, what future comforts and delights, resulted from this one small talent confided to the care of

a man of rare vision and fine intellectual sympathy, fired by the spirit of real love for his fellows! There is no instance in the history of the French people of a good deed done by stealth being of greater service to humanity.

De Clieu thus describes the events that followed fast upon the introduction of coffee into Martinique, with particular reference to the earthquake of 1727:

Success exceeded my hopes. I gathered about two pounds of seed which I distributed among all those whom I thought most capable of giving the plants the care necessary to their prosperity.

The first harvest was very abundant; with the second it was possible to extend the cultivation prodigiously, but what favored multiplication, most singularly, was the fact that two years afterward all the cocoa trees of the country, which were the resource and occupation of the people, were uprooted and totally destroyed by horrible tempests accompanied by an inundation which submerged all the land where these trees were planted, land which was at once made into coffee plantations by the natives. These did marvelously and enabled us to send plants to Santo Domingo, Guadeloupe, and other adjacent islands, where since that time they have been cultivated with the greatest success.

By 1777 there were 18,791,680 coffee trees in Martinique.

De Clieu was born in Angléqueville-sur-Saane, Seine-Inférieure (Normandy), in 1686 or 1688.<sup>5</sup> In 1705 he was a ship's ensign; in 1718 he became a chevalier of St. Louis; in 1720 he was made a captain of infantry; in 1726, a major of infantry; in 1733 he was a ship's lieutenant; in 1737 he became governor of Guadeloupe; in 1746 he was a ship's captain; in 1750 he was made honorary commander of the order of St. Louis; in 1752 he retired with a pension of 6000 francs; in 1753 he re-entered the naval service; in 1760 he again retired with a pension of 2000 francs.

In 1746 de Clieu having returned to France, was presented to Louis XV by the minister of marine, Rouillé de Jour, as "a distinguished officer to whom the colonies, as well as France itself, and commerce generally, are indebted for the cultivation of coffee."

Reports to the king in 1752 and 1759 recall his having carried the first coffee plant to Martinique, and that he had ever been distinguished for his zeal and disinterestedness. In the *Mercure de France*, December, 1774, was the following death notice:

Gabriel d'Erchigny de Clieu, former Ship's Captain and Honorary Commander of the Royal and Military Order of Saint Louis, died in Paris on the 30th of November in the 88th year of his age.

A notice of his death appeared also in the *Gazette de France* for December 5, 1774, a rare honor in both cases; and it has been said that at this time his praise was again on every lip.

One French historian, Sidney Daney, records that de Clieu died in poverty at St. Pierre at the age of 97; but this must be an error, although it does not anywhere appear that at his death he was possessed of much, if any, means. Daney says:

This generous man received as his sole recompense for a noble deed the satisfaction of seeing this plant for whose preservation he had shown such devotion, prosper throughout the Antilles. The illustrious de Clieu is among those to whom Martinique owes a brilliant reparation.<sup>6</sup>

Daney tells also that in 1804 there was a movement in Martinique to erect a monument upon the spot where de Clieu planted his first coffee plant, but that the undertaking came to naught.

Pardon, in his *La Martinique* says:

Honor to this brave man! He has deserved it from the people of two hemispheres. His name is worthy of a place beside that of Parmentier who carried to France the potato of Canada. These two men have rendered immense service to humanity, and their memory should never be forgotten—yet alas! Are they even remembered?

Tussac, in his *Flora de las Antillas*, writing of de Clieu, says, "Though no monument be erected to this beneficent traveler, yet his name should remain engraved in the heart of every colonist."

In 1774 the *Année Littéraire* published a long poem in de Clieu's honor. In the feuilleton of the *Gazette de France*, April 12, 1816, we read that M. Donns, a wealthy Hollander, and a coffee connoisseur, sought to honor de Clieu by having painted upon a porcelain service all the details of his voyage and its happy results. "I have seen the cups," says the writer, who gives many details and the Latin inscription.

That singer of navigation, Esménard, has pictured de Clieu's devotion in the following lines:

Forget not how de Clieu with his light vessel's  
sail,  
Brought distant Moka's gift—that timid plant  
and frail.

<sup>5</sup> Michaud, I. F. and L. G. *Biographie Universelle*. Paris.

<sup>6</sup> Daney, Sidney. *Histoire de la Martinique*. Fort Royal, 1846.

The waves fell suddenly, young zephyrs breathed  
no more,  
Beneath fierce Cancer's fires behold the fountain  
store,  
Exhausted, fails; while now inexorable need  
Makes her un pitying law—with measured dole  
obeyed.  
Now each soul fears to prove Tantalus torment  
first.  
De Clieu alone defies: While still that fatal  
thirst,  
Fierce, stifling, day by day his noble strength  
devours,  
And still a heaven of brass inflames the burning  
hours.  
With that refreshing draught his life he will not  
cheer;  
But drop by drop revives the plant he holds  
more dear:  
Already as in dreams, he sees great branches  
grow,  
One look at his dear plant assuages all his woe.

The only memorial to de Clieu in Martinique is the botanical garden at Fort de France, which was opened in 1918 and dedicated to de Clieu, "whose memory has been too long left in oblivion."<sup>7</sup>

In 1715 coffee cultivation was first introduced into Haiti and Santo Domingo. Later came hardier plants from Martinique. In 1715-17 the French Company of the Indies introduced the cultivation of the plant into the Isle of Bourbon, now Réunion, by a ship captain named Dufougeret-Grenier from St. Malo. It did so well that nine years later the island began to export coffee.

The Dutch brought the cultivation of coffee to Surinam in 1718. The first coffee plantation in Brazil was started at Pará in 1727 with plants brought from French Guiana. The English brought the plant to Jamaica in 1730. In 1740 Spanish missionaries introduced coffee cultivation into the Philippines from Java. In 1748 Don José Antonio Gelabert introduced coffee into Cuba, bringing the seed from Santo Domingo. In 1750 the Dutch extended the cultivation of the plant to the Celebes. Coffee was introduced into Guatemala

about 1750-60. The intensive cultivation in Brazil dates from the efforts begun in the Portuguese colonies in Pará, the Amazonas, and Maranhão in 1732. Puerto Rico began the cultivation of coffee about 1755. In 1760 João Alberto Castello Branco brought to Rio de Janeiro a coffee tree from Goa, Portuguese India. The news spread that the soil and climate of Brazil were particularly adapted to the cultivation of coffee. Molke, a Belgian monk, presented some seeds to the Capuchin monastery at Rio in 1774. Later, the bishop of Rio, Joachim Bruno, became a patron of the plant and encouraged its propagation in Rio, Minas, Espírito Santo, and São Paulo. The Spanish voyager, Don Francisco Xavier Navarro, is credited with the introduction of coffee into Costa Rica from Cuba in 1779. In Venezuela the industry was started near Caracas by a priest, José Antonio Mohe-dano, with seed brought from Martinique in 1784.

Coffee cultivation in Mexico began in 1790, the seed being brought from the West Indies. In 1817 Don Juan Antonio Gomez instituted intensive cultivation in the State of Vera Cruz. In 1825 the cultivation of the plant was begun in the Hawaiian Islands with seeds from Rio de Janeiro. As previously noted, the English began to cultivate coffee in India in 1840. In 1840 coffee cultivation was begun in Salvador with plants brought from Cuba. In 1878 the English began the propagation of coffee in British Central Africa, but it was not until 1901 that coffee cultivation was introduced into British East Africa from Réunion. In 1887 the French introduced the plant into Tonkin, Indo-China. Coffee growing in Queensland, introduced in 1896, has been successful in a small way.

In recent years several attempts have been made to propagate the coffee plant in the southern United States, but without success. It is believed, however, that the topographic and climatic conditions in southern California are favorable for its cultivation.

<sup>7</sup> *Inauguration du Jardin Desclieux*. Fort de France, 1918.







OMAR AND THE MARVELOUS COFFEE BIRD



KALDI AND HIS DANCING GOATS

THE LEGENDARY DISCOVERY OF THE COFFEE DRINK

From drawings by a modern French artist

## CHAPTER II

### EARLY HISTORY OF COFFEE DRINKING

COFFEE IN THE NEAR EAST IN THE EARLY CENTURIES—STORIES OF ITS ORIGIN—DISCOVERY BY PHYSICIANS AND ADOPTION BY THE CHURCH—ITS SPREAD THROUGH ARABIA, PERSIA AND TURKEY—PERSECUTIONS AND INTOLERANCES—EARLY COFFEE MANNERS AND CUSTOMS

THE coffee drink had its rise in the classical period of Arabian medicine, which dates from Rhazes (Abu Bakr Muhammad ibn Zakariya El Razi) who followed the doctrines of Galen and sat at the feet of Hippocrates. Rhazes (A. D. 850-922) was the first to treat medicine in an encyclopedic manner, and, according to some authorities, the first writer to mention coffee. He assumed the poetical name of Razi because he was a native of the city of Raj in Persian Iraq. He was a great philosopher and astronomer, and at one time was superintendent of the hospital at Bagdad. He wrote many learned books on medicine and surgery, but his principal work is *Al-Haiwi*, or *The Continent*, a collection of everything relating to the cure of disease from Galen to his own time.

Philippe Sylvestre Dufour (1622-87), a French coffee merchant, philosopher, and writer, in an accurate and finished treatise on coffee, tells us (see the early edition of the work translated from the Latin) that the first writer to mention the properties of the coffee bean, under the name of *bunchum*, was this same Rhazes, "in the ninth century after the birth of our Saviour";<sup>1</sup> from which (if true) it would appear that coffee has been known for upwards of 1000 years. Robinson, however, is of the opinion that *bunchum* meant something else and had nothing to do with coffee.<sup>2</sup> Dufour, himself, in a later edition of his *Traitez Nouveaux et Curieux du Café* (the Hague,

1693) is inclined to admit that *bunchum* may have been a root and not coffee, after all; however, he is careful to add that there is no doubt that the Arabs knew coffee as far back as the year 800. Other, more modern authorities, place it as early as the sixth century.

*Wiji Kawih* is mentioned in a Kavi (Javan) inscription A. D. 856; and it is thought that the "bean broth" in David Tapperi's list of Javanese beverages (1667-82) may have been coffee.<sup>3</sup>

While the true origin of coffee drinking may be forever hidden among the mysteries of the purple East, shrouded as it is in legend and fable, scholars have marshaled sufficient facts to prove that the beverage was known in Ethiopia "from time immemorial," and there is much to add verisimilitude to Dufour's narrative. This first coffee merchant-prince, skilled in languages and polite learning, considered that his character as a merchant was not inconsistent with that of an author; and he even went so far as to say there were some things (for instance, coffee) on which a merchant could be better informed than a philosopher.

Granting that by *bunchum* Rhazes meant coffee, the plant and the drink must have been known to his immediate followers; and this, indeed, seems to be indicated by similar references in the writings of Avicenna (Ibn Sina), the Mohammedan physician and philosopher, who lived from A. D. 980 to 1037.

Rhazes, in the quaint language of Du-

<sup>1</sup> Dufour, Philippe Sylvestre. *Traitez Nouveaux et Curieux du Café, du Thé, et du Chocolat*. Lyons, 1684. (Title page has *Traitez*; elsewhere, *Traitez*.)

<sup>2</sup> Robinson, Edward Forbes. *The Early History of Coffee Houses in England*. London, 1893.

<sup>3</sup> *Encyclopedia Britannica*. 1911. (vol. xv: p. 291.)

four, assures us that “*bunchum* (coffee) is hot and dry and very good for the stomach.” Avicenna explains the medicinal properties and uses of the coffee bean (*bun* or *bunn*), which he also calls *bunchum*, after this fashion:

As to the choice thereof, that of a lemon color, light, and of a good smell, is the best; the white and the heavy is naught. It is hot and dry in the first degree, and, according to others, cold in the first degree. It fortifies the members, it cleans the skin, and dries up the humidities that are under it, and gives an excellent smell to all the body.

The early Arabians called the bean and the tree that bore it, *bunn*; the drink, *bunchum*. A. Galland<sup>4</sup> (1646-1715), the French Orientalist who first analyzed and translated from the Arabia the Abd-al-Kadir manuscript<sup>5</sup>, the oldest document extant telling of the origin of coffee, observes that Avicenna speaks of the *bunn*, or coffee; as do also Prospero Alpini and Veslingius (Vesling). Bengiazlah, another great physician, contemporary with Avicenna, likewise mentions coffee; by which, says Galland, one may see that we are indebted to physicians for the discovery of coffee, as well as of sugar, tea, and chocolate.

Rauwolf<sup>6</sup> (d. 1596), German physician and botanist, and the first European to mention coffee, who became acquainted with the beverage in Aleppo in 1573, telling how the drink was prepared by the Turks, says:

In this same water they take a fruit called *Bunnu*, which in its bigness, shape, and color is almost like unto a bayberry with two thin shells surrounded, which, as they informed me, are brought from the *Indies*; but as these in themselves are, and have within them, two yellowish grains in two distinct cells, and besides, being they agree in their virtue, figure, looks, and name with the *Bunchum* of Avicenna and *Bunca* of *Rasis ad Almans* exactly: therefore I take them to be the same.

In Dr. Edward Pococke's translation (Oxford, 1659) of *The Nature of the Drink Kauhi, or Coffee, and the Berry of which it is Made, Described by an Arabian Physician*, we read:

*Bun* is a plant in *Yaman* [Yemen], which is planted in *Adar*, and groweth up and is gathered in *Ab*. It is about a cubit high, on a stalk about the thickness of one's thumb. It flowers white, leaving a berry like a small nut, but that some-

<sup>4</sup> Galland, Antoine. *Lettre sur l'Origine et le Progres du Café*. Paris, 1699.

<sup>5</sup> The Abd-al-Kadir manuscript is described and illustrated in chapter XXXVII.

<sup>6</sup> Rauwolf, Leonhard. *Eigentliche beschreibung der Rasis so er vor diser zeit gegen auffgang inn die morgenlaender vilbracht*. Lauwigen, 1582-83.

times it is broad like a bean; and when it is peeled, parteth in two. The best of it is that which is weighty and yellow; the worst, that which is black. It is hot in the first degree, dry in the second: it is usually reported to be cold and dry, but it is not so; for it is bitter, and whatsoever is bitter is hot. It may be that the scorce is hot, and the *Bun* it selfe either of equall temperature, or cold in the first degree.

That which makes for its coldnesse is its stiptickness. In summer it is by experience found to conduce to the drying of rheumes, and flegmatick coughes and distillations, and the opening of obstructions, and the provocation of urin. It is now known by the name of *Kohwah*. When it is dried and thoroughly boyled, it allayes the ebullition of the blood, is good against the small poxe and measles, the bloody pimples; yet causeth vertiginous headheach, and maketh lean much, occasioneth waking, and the Emrods, and asswageth lust, and sometimes breeds melancholly.

He that would drink it for liveliness sake, and to discusse slothfulness, and the other properties that we have mentioned, let him use much sweat meates with it, and oyle of pistaccioes, and butter. Some drink it with milk, but it is an error, and such as may bring in danger of the leprosy.

Dufour concludes that the coffee beans of commerce are the same as the *bunchum* (*bunn*) described by Avicenna and the *bunca* (*bunchum*) of Rhazes. In this he agrees, almost word for word, with Rauwolf, indicating no change in opinion among the learned in a hundred years.

Christopher Campen thinks Hippocrates, father of medicine, knew and administered coffee.

Robinson, commenting upon the early adoption of coffee into materia medica, charges that it was a mistake on the part of the Arab physicians, and that it originated the prejudice that caused coffee to be regarded as a powerful drug instead of as a simple and refreshing beverage.

#### *Homer, the Bible, and Coffee*

In early Grecian and Roman writings no mention is made of either the coffee plant or the beverage made from the berries. Pierre (Pietro) Della Valle<sup>7</sup> (1586-1652), however, maintains that the *nepenthe*, which Homer says Helen brought with her out of Egypt, and which she employed as surcease for sorrow, was nothing else but coffee mixed with wine.<sup>8</sup> This is disputed by M. Petit, a well known physician of

<sup>7</sup> Della Valle, Pierre (Pietro). *De Constantinople à Bombay, Lettres*. 1615. (vol. 1: p. 90.)

<sup>8</sup> “She mingled with the wine and the wondrous juice of a plant which banishes sadness and wrath from the heart and brings with it forgetfulness of every woe.”

Paris, who died in 1687. Several later British authors, among them, Sandys, the poet; Burton; and Sir Henry Blount, have suggested the probability of coffee being the "black broth" of the Lacedæmonians.

George Paschius, in his Latin treatise of

Pierre Étienne Louis Dumant, the Swiss Protestant minister and author, is of the opinion that coffee (and not lentils, as others have supposed) was the red pottage for which Esau sold his birthright; also that the parched grain that Boaz ordered to be given Ruth was undoubtedly roasted coffee berries.

Dufour mentions as a possible objection against coffee that "the use and eating of beans were heretofore forbidden by Pythagoras," but intimates that the coffee bean of Arabia is something different.

Scheuzer,<sup>9</sup> in his *Physique Sacrée*, says "the Turks and the Arabs make with the coffee bean a beverage which bears the same name, and many persons use as a substitute the flour of roasted barley." From this we learn that the coffee substitute is almost as old as coffee itself.

#### Some Early Legends

After medicine, the church. There are several Mohammedan traditions that have persisted through the centuries, claiming for "the faithful" the honor and glory of the first use of coffee as a beverage. One of these relates how, about A. D. 1258, Sheik Omar, a disciple of Sheik Abou'l hasan Schadheli, patron saint and legendary founder of Mocha, by chance discovered the coffee drink at Ousab in Arabia, whither he had been exiled for a certain moral remissness.

Facing starvation, he and his followers were forced to feed upon the berries growing around them. And then, in the words of the faithful Arab chronicle in the Bibliothèque Nationale at Paris, "having nothing to eat except coffee, they took of it and boiled it in a sauce-pan and drank of the decoction." Former patients in Mocha who sought out the good doctor-priest in his Ousab retreat, for physic with which to cure their ills, were given some of this decoction, with beneficial effect. As a result of the stories of its magical properties, carried back to the city, Sheik Omar was invited to return in triumph to Mocha where the governor caused to be built a monastery for him and his companions.

Another version of this Oriental legend gives it as follows:

The dervish Hadji Omar was driven by his enemies out of Mocha into the desert, where they

<sup>9</sup> Scheuzer, J. J. *Physique Sacrée, ou Histoire Naturelle de la Bible*. Amsterdam, 1732, 1737.

TRAITEZ  
Nouveaux & curieux  
DU CAFE,  
DU THE'  
ET DU  
CHOCOLATE.

Ouvrage également necessaire aux  
Medecins, & à tous ceux qui  
aiment leur santé.

Par PHILIPPE SYLVESTRE DUFOUR

*A quoy on a adjouté dans cette Edition, la meilleure de toutes les methodes, qui manquoit à ce Livre, pour composer*

L'EXCELLENT CHOCOLATE.

Par Mr. St. DISDIER.

Troisième Edition.



A LA HAYE;

Chez ADRIAN MOETJENS, Marchand Libraire prez la Cour, à la Librairie Française.

M. DC. XCIII.

TITLE PAGE OF DUFOUR'S BOOK, EDITION OF 1693

the *New Discoveries Made since the Time of the Ancients*, printed at Leipsic in 1700, says he believes that coffee was meant by the five measures of parched corn included among the presents Abigail made to David to appease his wrath, as recorded in the *Bible*, 1 Samuel, xxv, 18. The *Vulgate* translates the Hebrew words *sein kali* into *sata polentea*, which signify wheat, roasted, or dried by fire.

1159 Tea: BERGUY (M. d.) LE BON USAGE DU THÉ, du Caffé et du Chocolat pour la preservation et pour la guérison des Maladies, frontispiece and 13 full-page engravings (one repeating the frontispiece), 12mo, contemporary calf, (joints repaired), Paris, £35 chez l'Auteur, 1687

Vicaire 97. Birting 44.



expected he would die of starvation. This undoubtedly would have occurred if he had not plucked up courage to taste some strange berries which he found growing on a shrub. While they seemed to be edible, they were very bitter; and he tried to improve the taste by roasting them. He found, however, that they had become very hard, so he attempted to soften them with water. The berries seemed to remain as hard as before, but the liquid turned brown, and Omar drank it on the chance that it contained some of the nourishment from the berries. He was amazed at how it refreshed him, enlivened his sluggishness, and raised his drooping spirits. Later, when he returned to Mocha, his salvation was considered a miracle. The beverage to which it was due sprang into high favor, and Omar himself was made a saint.

A popular and much-quoted version of Omar's discovery of coffee, also based upon the Abd-al-Kadir manuscript, is the following:

In the year of the Hegira 656, the mollah Schadheli went on a pilgrimage to Mecca. Arriving at the mountain of the Emeralds (Ousab), he turned to his disciple Omar and said: "I shall die in this place. When my soul has gone forth, a veiled person will appear to you. Do not fail to execute the command which he will give you."

The venerable Schadheli being dead, Omar saw in the middle of the night a gigantic specter covered by a white veil.

"Who are you?" he asked.

The phantom drew back his veil, and Omar saw with surprise Schadheli himself, grown ten cubits since his death. The mollah dug in the ground, and water miraculously appeared. The spirit of his teacher bade Omar fill a bowl with the water and to proceed on his way and not to stop till he reached the spot where the water would stop moving.

"It is there," he added, "that a great destiny awaits you."

Omar started his journey. Arriving at Mocha in Yemen, he noticed that the water was immovable. It was here that he must stop.

The beautiful village of Mocha was then ravaged by the plague. Omar began to pray for the sick and, as the saintly man was close to Mahomet, many found themselves cured by his prayers.

The plague meanwhile progressing, the daughter of the King of Mocha fell ill and her father had her carried to the home of the dervish who cured her. But as this young princess was of rare beauty, after having cured her, the good dervish tried to carry her off. The king did not fancy this new kind of reward. Omar was driven from the city and exiled on the mountain of Ousab, with herbs for food and a cave for a home.

"Oh, Schadheli, my dear master," cried the unfortunate dervish one day; "if the things which happened to me at Mocha were destined, was it worth the trouble to give me a bowl to come here?"

To these just complaints, there was heard immediately a song of incomparable harmony, and a bird of marvelous plumage came to rest in a

tree. Omar sprang forward quickly toward the little bird which sang so well, but then he saw on the branches of the tree only flowers and fruit. Omar laid hands on the fruit, and found it delicious. Then he filled his great pockets with it and went back to his cave. As he was preparing to boil a few herbs for his dinner, the idea came to him of substituting for this sad soup, some of his harvested fruit. From it he obtained a savory and perfumed drink; it was coffee.

The *Italian Journal of the Savants* for the year 1760 says that two monks, Scialdi and Ayduis, were the first to discover the properties of coffee, and for this reason became the object of special prayers. "Was not this Scialdi identical with the Sheik Schadheli?" asks Jardin.<sup>10</sup>

The most popular legend ascribes the discovery of the drink to an Arabian herdsman in upper Egypt, or Abyssinia, who complained to the abbot of a neighboring monastery that the goats confided to his care became unusually frolicsome after eating the berries of certain shrubs found near their feeding grounds. The abbot, having observed the fact, determined to try the virtues of the berries on himself. He, too, responded with a new exhilaration. Accordingly, he directed that some be boiled, and the decoction drunk by his monks, who thereafter found no difficulty in keeping awake during the religious services of the night. The abbé Massieu in his poem *Carmen Caffaeum*, thus celebrates the event:

The monks each in turn, as the evening draws near,  
Drink 'round the great cauldron—a circle of cheer!  
And the dawn in amaze, revisiting that shore,  
On idle beds of ease surprised them nevermore!

According to the legend, the news of the "wakeful monastery" spread rapidly, and the magical berry soon "came to be in request throughout the whole kingdom; and in progress of time other nations and provinces of the East fell into the use of it."

The French have preserved the following picturesque version of this legend:

A young goatherd named Kaldi noticed one day that his goats, whose deportment up to that time had been irreproachable, were abandoning themselves to the most extravagant prancings. The venerable buck, ordinarily so dignified and solemn, bounded about like a young kid. Kaldi attributed this foolish gaiety to certain fruits of which the goats had been eating with delight.

<sup>10</sup> Jardin, *Édelestan. Le Cafétier et le Café*. Paris, 1895.

The story goes that the poor fellow had a heavy heart; and in the hope of cheering himself up a little, he thought he would pick and eat of the fruit. The experiment succeeded marvelously. He forgot his troubles and became the happiest herder in happy Arabia. When the goats danced, he gaily made himself one of the party, and entered into their fun with admirable spirit.

One day, a monk chanced to pass by and stopped in surprise to find a ball going on. A score of goats were executing lively pirouettes

the fruit of the herder. This ingenious concoction gave us coffee. Immediately all the monks of the realm made use of the drink, because it encouraged them to pray and, perhaps, also because it was not disagreeable.

In those early days it appears that the drink was prepared in two ways; one in which the decoction was made from the hull and the pulp surrounding the bean, and the other from the bean itself. The roasting process came later and is an improvement generally credited to the Persians. There is evidence that the early Mohammedan churchmen were seeking a substitute for the wine forbidden to them by the Koran, when they discovered coffee. The word for coffee in Arabic, *qahwah*, is the same as one of those used for wine; and later on, when coffee drinking grew so popular as to threaten the very life of the church itself, this similarity was seized upon by the church-leaders to support their contention that the prohibition against wine applied also to coffee.

La Roque,<sup>11</sup> writing in 1715, says that the Arabian word *cahouah* signified at first only wine; but later was turned into a generic term applied to all kinds of drink. "So there were really three sorts of coffee; namely, wine, including all intoxicating liquors; the drink made with the shells, or cods, of the coffee bean; and that made from the bean itself."

Originally, then, the coffee drink may have been a kind of wine made from the coffee fruit. In the coffee countries even today the natives are very fond, and eat freely, of the ripe coffee cherries, voiding the seeds. The pulp surrounding the coffee seeds (beans) is pleasant to taste, has a sweetish, aromatic flavor, and quickly ferments when allowed to stand.

Still another tradition—was the wish father to the thought?—tells how the coffee drink was revealed to Mohammed himself by the Angel Gabriel. Coffee's partisans found satisfaction in a passage in the *Koran* which, they said, foretold its adoption by the followers of the Prophet:

They shall be given to drink an excellent wine, sealed; its seal is that of the musk.

The most diligent research does not carry a knowledge of coffee back beyond the time of Rhazes, two hundred years after Mohammed; so there is little more than specu-



TRAITE'S NOUVEAUX & CURIEUX DV  
CAFE DV THE, ET DV CHOCOLATE.

Composé  
Par Philippe Sylvestre Dufour,

ARAB DRINKING COFFEE; CHINAMAN, TEA; AND  
INDIAN, CHOCOLATE

Frontispiece from Dufour's work

like a ladies' chain, while the buck solemnly *balancé*-ed, and the herder went through the figures of an eccentric pastoral dance.

The astonished monk inquired the cause of this saltatorial madness; and Kaldi told him of his precious discovery.

Now, this poor monk had a great sorrow; he always went to sleep in the middle of his prayers; and he reasoned that Mohammed without doubt was revealing this marvelous fruit to him to overcome his sleepiness.

Piety does not exclude gastronomic instincts. Those of our good monk were more than ordinary; because he thought of drying and boiling

<sup>11</sup> La Roque, Jean. *Voyage dans l'Arabie Heureuse, de 1708 à 1713, et Traité Historique du Café*. Paris, 1715. (pp. 247, 251.)



lation or conjecture to support the theory that it was known to the ancients, in Bible times or in the days of The Praised One. Our knowledge of tea goes back to the early centuries of the Christian era. We know also that tea was intensively cultivated and taxed under the T'ang dynasty in China, A. D. 793, and that Arab traders knew of it in the following century.

#### *The First Reliable Coffee Date*

About 1454 Sheik Gemaleddin Abou Muhammad Bensaid, mufti of Aden, surnamed Aldhabhani, from Dhabhan, a small town where he was born, became acquainted with the virtues of coffee on a journey into Abyssinia.<sup>12</sup> Upon his return to Aden, his health became impaired; and remembering the coffee he had seen his countrymen drinking in Abyssinia, he sent for some in the hope of finding relief. He not only recovered from his illness; but, because of its sleep-dispelling qualities, he sanctioned the use of the drink among the dervishes "that they might spend the night in prayers or other religious exercises with more attention and presence of mind."<sup>13</sup>

It is altogether probable that the coffee drink was known in Aden before the time of Sheik Gemaleddin; but the endorsement of the very learned imam, whom science and religion had already made famous, was sufficient to start a vogue for the beverage that spread throughout Yemen, and thence to the far corners of the world. We read in the Arabian manuscript at the Bibliothèque Nationale that lawyers, students, as well as travelers who journeyed at night, artisans, and others, who worked at night, to escape the heat of the day, took to drinking coffee; and even left off another drink, then becoming popular, made from the leaves of a plant called *khat* or *cat* (*catha edulis*).

Sheik Gemaleddin was assisted in his work of spreading the gospel of this the first propaganda for coffee by one Muhammed Alhadrami, a physician of great reputation, born in Hadramaut, Arabia Felix.

A recently unearthed and little known version of coffee's origin shows how features of both the Omar tradition and the Gemaleddin story may be combined by a professional Occidental tale-writer:

<sup>12</sup> *Adjam*, by many writers wrongly rendered Persia.  
<sup>13</sup> Scheuzer, J. J. *Physique Sacrée, ou Histoire Naturelle de la Bible*. Amsterdam, 1732, 1737.

Toward the middle of the fifteenth century, a poor Arab was traveling in Abyssinia. Finding himself weak and weary, he stopped near a grove. For fuel wherewith to cook his rice, he cut down a tree that happened to be covered with dried berries. His meal being cooked and eaten, the traveler discovered that these half-burnt berries were fragrant. He collected a number of them and, on crushing them with a stone, found that the aroma was increased to a great extent. While wondering at this, he accidentally let the substance fall into an earthen vessel that contained his scanty supply of water.

A miracle! The almost putrid water was purified. He brought it to his lips; it was fresh and agreeable; and after a short rest the traveler so far recovered his strength and energy as to be able to resume his journey. The lucky Arab gathered as many berries as he could, and having arrived at Aden, informed the mufti of his discovery. That worthy was an inveterate opium-smoker, who had been suffering for years from the influence of the poisonous drug. He tried an infusion of the roasted berries, and was so delighted at the recovery of his former vigor that in gratitude to the tree he called it *cahuha* which is Arabic signifies "force."<sup>14</sup>

Galland, in his analysis of the Arabian manuscript, already referred to, that has furnished us with the most trustworthy account of the origin of coffee, criticizes Antoine Faustus Nairon, Maronite professor of Oriental languages at Rome, who was the author of the first printed treatise on coffee only,<sup>15</sup> for accepting the legends relating to Omar and the Abyssinian goatherd. He says they are unworthy of belief as facts of history, although he is careful to add that there is *some* truth in the story of the discovery of coffee by the Abyssinian goats and the abbot who prescribed the use of the berries for his monks, "the Eastern Christians being willing to have the honor of the invention of coffee, for the abbot, or prior, of the convent and his companions are only the mufti Gemaleddin and Muhammid Alhadrami, and the monks are the dervishes."

Amid all these details, Jardin reaches the conclusion that it is to chance we must attribute the knowledge of the properties of coffee, and that the coffee tree was transported from its native land to Yemen, as far as Mecca, and possibly into Persia, before being carried into Egypt.

Coffee, being thus favorably introduced into Aden, it has continued there ever since, without interruption. By degrees the cultivation of the plant and the use of the beverage passed into many neighbor-

<sup>14</sup> *Harper's Weekly*. New York, 1911. (Jan. 21.)  
<sup>15</sup> Nairon, Antoine Faustus. *De Saluberrimâ Cahue seu Cafè nuncupata Discursus*. Rome, 1671.

ing places. Toward the close of the fifteenth century (1470-1500) it reached Mecca and Medina, where it was introduced, as at Aden, by the dervishes, and for the same religious purpose. About 1510 it reached Grand Cairo in Egypt, where the dervishes from Yemen, living in a district by themselves, drank coffee on the nights they intended to spend in religious devotion. They kept it in a large red earthen vessel, each in turn receiving it, respectfully, from their superior, in a small bowl, which he dipped into the jar, in the meantime chanting their prayers, the burden of which was always: "There is no God but one God, the true King, whose power is not to be disputed."

After the dervishes, the bowl was passed to lay members of the congregation. In this way coffee came to be so associated with the act of worship that "they never performed a religious ceremony in public and never observed any solemn festival without taking coffee."

Meanwhile, the inhabitants of Mecca became so fond of the beverage that, disregarding its religious associations, they made of it a secular drink to be sipped publicly in *kaveh kanes*, the first coffee houses. Here the idle congregated to drink coffee, to play chess and other games, to discuss the news of the day, and to amuse themselves with singing, dancing, and music, contrary to the manners of the rigid Mohammedans, who were very properly scandalized by such performances. In Medina and in Cairo, too, coffee became as common a drink as in Mecca and Aden.

#### *The First Coffee Persecution*

At length the pious Mohammedans began to disapprove of the use of coffee among the people. For one thing, it made common one of the best psychology-adjuncts of their religion; also, the joy of life, that it helped to liberate among those who frequented the coffee houses, precipitated social, political, and religious arguments; and these frequently developed into disturbances. Dissensions arose even among the churchmen themselves. They divided into camps for and against coffee. The law of the Prophet on the subject of wine was variously construed as applying to coffee.

About this time (1511) Kair Bey was governor of Mecca for the sultan of Egypt.

He appears to have been a strict disciplinarian, but lamentably ignorant of the actual conditions obtaining among his people. As he was leaving the mosque one evening after prayers, he was offended by seeing in a corner a company of coffee drinkers who were preparing to pass the night in prayer. His first thought was that they were drinking wine; and great was his astonishment when he learned what the liquor really was and how common was its use throughout the city. Further investigation convinced him that indulgence in this exhilarating drink must incline men and women to extravagances prohibited by law, and so he determined to suppress it. First he drove the coffee drinkers out of the mosque.

The next day, he called a council of officers of justice, lawyers, physicians, priests, and leading citizens, to whom he declared what he had seen the evening before at the mosque; and, "being resolved to put a stop to the coffee-house abuses, he sought their advice upon the subject." The chief count in the indictment was that "in these places men and women met and played tambourines, violins, and other musical instruments. There were also people who played chess, *mankala*, and other similar games, for money; and there were many other things done contrary to our sacred law—may God keep it from all corruption until the day when we shall all appear before him."<sup>16</sup>

The lawyers agreed that the coffee houses needed reforming; but as to the drink itself, inquiry should be made as to whether it was in any way harmful to mind or body; for if not, it might not be sufficient to close the places that sold it. It was suggested that the opinion of the physicians be sought.

Two brothers, Persian physicians named Hakimani, and reputed the best in Mecca, were summoned, although we are told they knew more about logic than they did about physic. One of them came into the council fully prejudiced, as he had already written a book against coffee, and filled with concern for his profession, being fearful lest the common use of the new drink would make serious inroads on the practice of medicine. His brother joined with him in assuring the assembly that the

<sup>16</sup> de Sacy, Baron Antoine Isaac Silvestre. *Chrestomathie Arabe*. Paris, 1806. (vol. ii: p. 224.)

plant *bunn*, from which coffee was made, was "cold and dry" and so unwholesome. When another physician present reminded them that Bengiazlah, the ancient and respected contemporary of Avicenna, taught that it was "hot and dry," they made arbitrary answer that Bengiazlah had in mind another plant of the same name, and that anyhow, it was not material; for, if the coffee drink disposed people to things forbidden by religion, the safest course for Mohammedans was to look upon it as unlawful.

The friends of coffee were covered with confusion. Only the mufti spoke out in the meeting in its favor. Others, carried away by prejudice or misguided zeal, affirmed that coffee clouded their senses. One man arose and said it intoxicated like wine; which made every one laugh, since he could hardly have been a judge of this if he had not drunk wine, which is forbidden by the Mohammedan religion. Upon being asked whether he had ever drunk any, he was so imprudent as to admit that he had, thereby condemning himself out of his own mouth to the bastinado.

The mufti of Aden, being both an officer of the court and a divine, undertook, with some heat, a defense of coffee; but he was clearly in an unpopular minority. He was rewarded with the reproaches and affronts of the religious zealots.

So the governor had his way, and coffee was solemnly condemned as a thing forbidden by the law; and a presentment was drawn up, signed by a majority of those present, and dispatched post-haste by the governor to his royal master, the sultan, at Cairo. At the same time, the governor published an edict forbidding the sale of coffee in public or private. The officers of justice caused all the coffee houses in Mecca to be shut, and ordered all the coffee found there, or in the merchants' warehouses, to be burned.

Naturally enough, being an unpopular edict, there were many evasions, and much coffee drinking took place behind closed doors. Some of the friends of coffee were outspoken in their opposition to the order, being convinced that the assembly had rendered a judgment not in accordance with the facts, and above all, contrary to the opinion of the mufti who, in every Arab community, is looked up to as the interpreter, or expounder, of the law. One man, caught in the act of disobedience, besides

being severely punished, was also led through the most public streets of the city seated on an ass.

However, the triumph of the enemies of coffee was short-lived; for not only did the sultan of Cairo disapprove the "indiscreet zeal" of the governor of Mecca, and order the edict revoked; but he read him a severe lesson on the subject. How dared he condemn a thing approved at Cairo, the capital of his kingdom, where there were physicians whose opinions carried more weight than those of Mecca, and who had found nothing against the law in the use of coffee? The best things might be abused, added the sultan, even the sacred waters of Zamzam, but this was no reason for an absolute prohibition. The fountain, or well, of Zamzam, according to the Mohammedan teaching, is the same which God caused to spring up in the desert to comfort Hagar and Ishmael when Abraham banished them. It is in the enclosure of the temple at Mecca; and the Mohammedans drink of it with much show of devotion, ascribing great virtues to it.

It is not recorded whether the misguided governor was shocked at this seeming profanity; but it is known that he hastened to obey the orders of his lord and master. The prohibition was recalled, and thereafter he employed his authority only to preserve order in the coffee houses. The friends of coffee, and the lovers of poetic justice, found satisfaction in the governor's subsequent fate. He was exposed as "an extortioner and a public robber," and "tortured to death," his brother killing himself to avoid the same fate. The two Persian physicians who had played so mean a part in the first coffee persecution, likewise came to an unhappy end. Being discredited in Mecca they fled to Cairo, where, in an unguarded moment, having cursed the person of Selim I, emperor of the Turks, who had conquered Egypt, they were executed by his order.

Coffee, being thus re-established at Mecca, met with no opposition until 1524, when, because of renewed disorders, the kadi of the town closed the coffee houses, but did not seek to interfere with coffee drinking at home and in private. His successor, however, re-licensed them; and, continuing on their good behavior since then, they have not been disturbed.

In 1542 a ripple was caused by an order issued by Soliman the Great, forbidding

the use of coffee; but no one took it seriously, especially as it soon became known that the order had been obtained "by surprise" and at the desire of only one of the court ladies "a little too nice in this point."

One of the most interesting facts in the history of the coffee drink is that wherever it has been introduced it has spelled revolution. It has been the world's most radical drink in that its function has always been to make people think. And when the people began to think, they became dangerous to tyrants and to foes of liberty of thought and action. Sometimes the people became intoxicated with their new found ideas and, mistaking liberty for license, they ran amok, calling down upon their heads persecutions and many petty intolerances. So history repeated itself in Cairo, twenty-three years after the first Mecca persecution.

#### *Coffee's Second Religious Persecution*

Selim I, after conquering Egypt, had brought coffee to Constantinople in 1517. The drink continued its progress through Syria, and was received in Damascus about 1530, and in Aleppo about 1532, without opposition. Several coffee houses of Damascus attained wide fame, among them the Café of the Roses, and the Café of the Gate of Salvation.

Coffee's increasing popularity and, perhaps, the realization that the continued spread of the beverage might lessen the demand for his services, caused a physician of Cairo, about 1523, to propound to his fellows this question:

What is your opinion concerning the liquor called coffee which is drank in company, as being reckoned in the number of those we have free leave to make use of, notwithstanding it is the cause of no small disorders, that it flies up into the head and is very pernicious to health? Is it permitted or forbidden?

At the end he was careful to add, as his own opinion—and without prejudice?—that coffee was unlawful. To the credit of the physicians of Cairo as a class, it should be recorded that they looked with unsympathetic eyes upon this attempt on the part of one of their number to stir up trouble for a valuable adjunct to their *materia medica*, and so the effort died a-borning.

If the physicians were disposed to do nothing to stop coffee's progress, not so

the preachers. As places of resort, the coffee houses exercised an appeal that proved stronger to the popular mind than that of the temples of worship. This to men of sound religious training was intolerable. The feeling against coffee smouldered for a time, but in 1534 it broke out afresh. In that year a fiery preacher in one of Cairo's mosques so played upon the emotions of his congregation with a preachment against coffee, claiming that it was against the law and that those who drank it were not true Mohammedans, that upon leaving the building a large number of his hearers, enraged, threw themselves into the first coffee house they found in their way, burned the coffee pots and dishes, and maltreated all the persons they found there.

Public opinion was immediately aroused; and the city was divided into two parties; one maintaining that coffee was against the law of Mohammed, and the other taking the contrary view. And then arose a Solomon in the person of the chief justice, who summoned into his presence the learned physicians for consultation. Again the medical profession stood by its guns. The medical men pointed out to the chief justice that the question had already been decided by their predecessors on the side of coffee, and that the time had come to put some check "on the furious zeal of the bigots" and the "indiscretions of ignorant preachers." Whereupon, the wise judge caused coffee to be served to the whole company and drank some himself. By this act he "re-united the contending parties, and brought coffee into greater esteem than ever."

#### *Coffee in Constantinople*

The story of the introduction of coffee into Constantinople shows that it experienced much the same vicissitudes that marked its advent at Mecca and Cairo. There were the same disturbances, the same unreasoning religious superstition, the same political hatreds, the same stupid interference by the civil authorities; and yet, in spite of it all, coffee attained new honors and new fame. The Oriental coffee house reached its supreme development in Constantinople.

Although coffee had been known in Constantinople since 1517, it was not until 1554 that the inhabitants became acquainted

with that great institution of early eastern democracy, the coffee house. In that year, under the reign of Soliman the Great, son of Selim I, one Schemsi of Damascus and one Hekem of Aleppo opened the first two coffee houses in the quarter called Taktacalah. They were wonderful institutions for those days, remarkable alike for their furnishings and their comforts, as well as for the opportunity they afforded for social intercourse and free discussion. Schemsi and Hekem received their guests on "very neat couches or sofas," and the admission was the price of a dish of coffee—about one cent.

Turks, high and low, took up the idea with avidity. Coffee houses increased in number. The demand outstripped the supply. In the seraglio itself special officers (*kahvedjibachi*) were commissioned to prepare the coffee drink for the sultan. Coffee was in favor with all classes.

The Turks gave to the coffee houses the name *kahveh kanes—diversoria*, Cotovicus called them; and as they grew in popularity, they became more and more luxurious. There were lounges, richly carpeted; and in addition to coffee, many other means of entertainment. To these "schools of the wise" came the "young men ready to enter upon offices of judicature; kadis from the provinces, seeking re-instatement or new appointments; muderys, or professors; officers of the seraglio; bashaws; and the principal lords of the port," not to mention merchants and travelers from all parts of the then known world.

#### *Coffee House Persecutions*

About 1570, just when coffee seemed settled for all time in the social scheme, the imams and dervishes raised a loud wail against it, saying the mosques were almost empty, while the coffee houses were always full. Then the preachers joined in the clamor, affirming it to be a greater sin to go to a coffee house than to enter a tavern. The authorities began an examination; and the same old debate was on. This time, however, appeared a mufti who was unfriendly to coffee. The religious fanatics argued that Mohammed had not even known of coffee, and so could not have used the drink, and, therefore, it must be an abomination for his followers to do so. Further, coffee was burned and ground to charcoal before making a drink of it; and

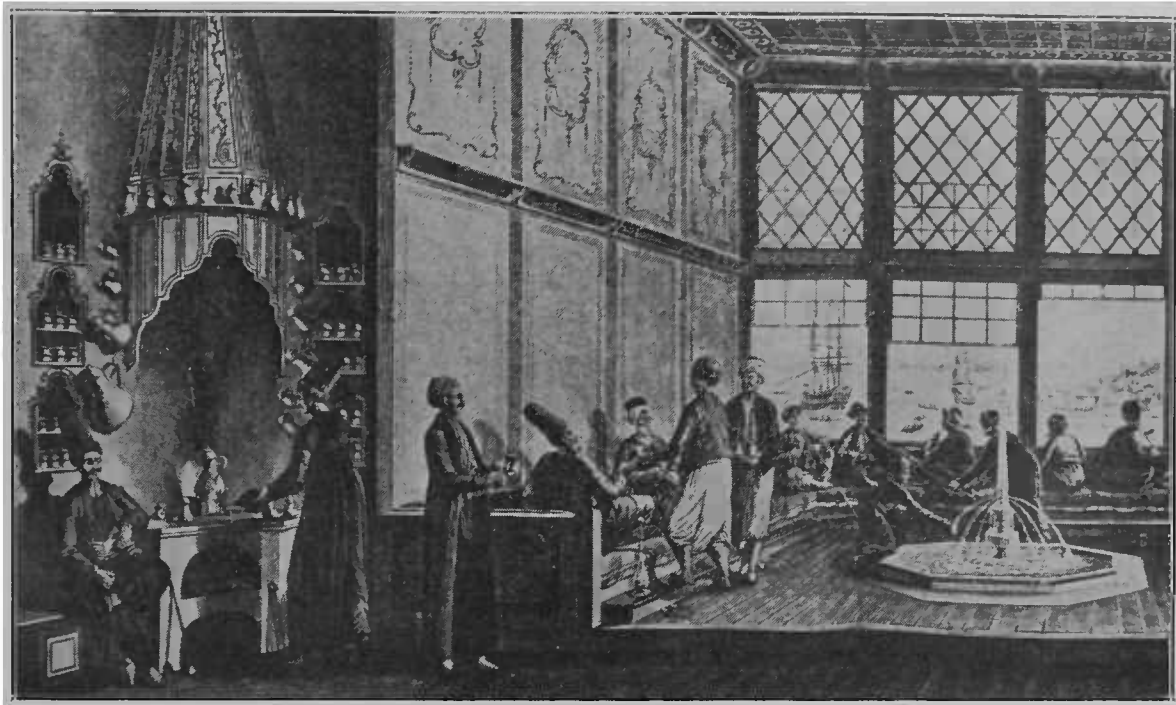
the *Koran* distinctly forbade the use of charcoal, including it among the unsanitary foods. The mufti decided the question in favor of the zealots, and coffee was forbidden by law.

The prohibition proved to be more honored in the breach than in the observance. Coffee drinking continued in secret, instead of in the open. And when, about 1580, Amurath III, at the further solicitation of the churchmen, declared in an edict that coffee should be classed with wine, and so prohibited in accordance with the law of the Prophet, the people only smiled, and persisted in their secret disobedience. Already they were beginning to think for themselves on religious as well as political matters. The civil officers, finding it useless to try to suppress the custom, winked at violations of the law; and, for a consideration, permitted the sale of coffee privately, so that many Ottoman "speakeasies" sprang up—places where coffee might be had behind shut doors; shops where it was sold in back-rooms.

This was enough to re-establish the coffee houses by degrees. Then came a mufti less scrupulous or more knowing than his predecessor, who declared that coffee was not to be looked upon as coal, and that the drink made from it was not forbidden by the law. There was a general renewal of coffee drinking; religious devotees, preachers, lawyers, and the mufti himself indulging in it, their example being followed by the whole court and the city.

After this, the coffee houses provided a handsome source of revenue to each succeeding grand vizier; and there was no further interference with the beverage until the reign of Amurath IV, when Grand Vizier Kuprili, during the war with Candia, decided that for political reasons, the coffee houses should be closed. His argument was much the same as that advanced more than a hundred years later by Charles II of England, namely, that they were hotbeds of sedition. Kuprili was a military dictator, with nothing of Charles's vacillating nature; and although, like Charles, he later rescinded his edict, he enforced it, while it was effective, in no uncertain fashion. Kuprili was no petty tyrant. For a first violation of the order, cudgeling was the punishment; for a second offense, the victim was sewn in a leather bag and thrown into the Bosphorus. Strangely enough, while he suppressed the coffee





CHARACTERISTIC SCENE IN A TURKISH COFFEE HOUSE OF THE SEVENTEENTH CENTURY

houses, he permitted the taverns, that sold wine forbidden by the *Koran*, to remain open. Perhaps he found the latter produced a less dangerous kind of mental stimulation than that produced by coffee. Coffee, says Virey, was too intellectual a drink for the fierce and senseless administration of the pashas.

Even in those days it was not possible to make people good by law. Paraphrasing the copy-book, suppressed desires will arise, though all the world o'erwhelm them, to men's eye. An unjust law was no more enforceable in those centuries than it is in the twentieth century. Men are humans first, although they may become brutish when bereft of reason. But coffee does not steal away their reason; rather, it sharpens their reasoning faculties. As Galland has truly said: "Coffee joins men, born for society, in a more perfect union; protestations are more sincere in being made at a time when the mind is not clouded with fumes and vapors, and therefore not easily forgotten, which too frequently happens when made over a bottle."

Despite the severe penalties staring them in the face, violations of the law were plentiful among the people of Constantinople. Venders of the beverage appeared in the market-places with "large copper vessels with fire under them; and those who had

a mind to drink were invited to step into any neighboring shop where every one was welcome on such an account."

Later, Kuprili, having assured himself that the coffee houses were no longer a menace to his policies, permitted the free use of the beverage that he had previously forbidden.

#### *Coffee and Coffee Houses in Persia*

Some writers claim for Persia the discovery of the coffee drink; but there is no evidence to support the claim. There are, however, sufficient facts to justify a belief that here, as in Ethiopia, coffee has been known from time immemorial—which is a very convenient phrase. At an early date the coffee house became an established institution in the chief towns. The Persians appear to have used far more intelligence than the Turks in handling the political phase of the coffee-house question, and so it never became necessary to order them suppressed in Persia.

The wife of Shah Abbas, observing that great numbers of people were wont to gather and to talk politics in the leading coffee house of Ispahan, appointed a mollah—an ecclesiastical teacher and expounder of the law—to sit there daily to entertain the frequenters of the place with



nically turned points of history, law, and poetry. Being a man of wisdom and great tact, he avoided controversial questions of state; and so politics were kept in the background. He proved a welcome visitor, and was made much of by the guests. This example was generally followed, and as a result disturbances were rare in the coffee houses of Ispahan.

Adam Olearius, 1599-1671, who was secretary to the German Embassy that traveled in Turkey in 1633-36, tells of the great diversions made in Persian coffee houses "by their poets and historians, who are seated in a high chair from whence they make speeches and tell satirical stories, playing in the meantime with a little stick and using the same gestures as our jugglers and legerdemain men do in England."<sup>17</sup>

At court conferences conspicuous among the shah's retinue were always to be seen the *kahvedjibachi*, or "coffee-pourers."

#### *Early Coffee Manners and Customs*

The Chevalier d'Arvieux, French traveler in the Orient, tells how, in 1682, the virtues of fresh roasting and fresh grinding were known to the Bedouins of Arabia.<sup>18</sup>

Karstens Niebuhr, 1733-1815, the Hanoverian traveler, furnishes the following description of the early Arabian, Syrian, and Egyptian coffee houses:

They are commonly large halls, having their floors spread with mats, and illuminated at night by a multitude of lamps. Being the only theaters for the exercise of profane eloquence, poor scholars attend here to amuse the people. Select portions are read, *e. g.* the adventures of Rustan Sal, a Persian hero. Some aspire to the praise of invention, and compose tales and fables. They walk up and down as they recite, or assuming oratorical consequence, harangue upon subjects chosen by themselves.

In one coffee house at Damascus an orator was regularly hired to tell his stories at a fixed hour; in other cases he was more directly dependent upon the taste of his hearers, as at the conclusion of his discourse, whether it had consisted of literary topics or of loose and idle tales, he looked to the audience for a voluntary contribution.

At Aleppo, again, there was a man with a soul above the common, who, being a person of distinction, and one that studied merely for his own pleasure, had yet gone the round of all

the coffee houses in the city to pronounce moral harangues.<sup>19</sup>

In some coffee houses there were singers and dancers, as before, and many came to listen to the marvelous tales of the *Thousand and One Nights*.

In Oriental countries it was once the custom to offer a cup of "bad coffee," *i. e.*, coffee containing poison, to those functionaries or other persons who had proven themselves embarrassing to the authorities.

While coffee drinking started as a private religious function, it was not long after its introduction by the coffee houses that it became secularized still more in the homes of the people, although for centuries it retained a certain religious significance. Galland says that in Constantinople, at the time of his visit to the city, there was no house, rich or poor, Turk or Jew, Greek or Armenian, where it was not drunk at least twice a day, and many drank it oftener, for it became a custom in every house to offer it to all visitors; and it was considered an incivility to refuse it. Twenty dishes a day, per person, was not an uncommon average.

Galland observes that "as much money must be spent in the private families of Constantinople for coffee as for wine at Paris," and relates that it is as common for beggars to ask for money to buy coffee, as it is in Europe to ask for money to buy wine or beer.

At this time to refuse or to neglect to give coffee to their wives was a legitimate cause for divorce among the Turks. The men made promise when marrying never to let their wives be without coffee. "That," says Fulbert de Monteith, "is perhaps more prudent than to swear fidelity."

Another Arabic manuscript by Bichivili in the Bibliothèque Nationale at Paris furnishes us with this pen picture of the coffee ceremony as practised in Constantinople in the sixteenth century:

In all the great men's houses, there are servants whose business it is only to take care of the coffee; and the head officer among them, or he who has the inspection over all the rest, has an apartment allowed him near the hall which is destined for the reception of visitors. The Turks call this officer *Karveghi*, that is, Overseer or Steward of the Coffee. In the harem or ladies' apartment in the seraglio, there are a great many such officers, each having forty or

<sup>17</sup> Olearius, Adam. *An Account of His Journeys*. London, 1669.

<sup>18</sup> d'Arvieux, Chevalier Laurence. *Memoirs*. London, 1732.

<sup>19</sup> Niebuhr, Karstens. *Description of Arabia*. Amsterdam, 1774. (Heron trans., London, 1792; p. 266.)



SERVING COFFEE TO A GUEST.—AFTER A DRAWING IN AN EARLY EDITION OF "ARABIAN NIGHTS"

fifty *Baltagis* under them, who, after they have served a certain time in these coffee-houses, are sure to be well provided for, either by an advantageous post, or a sufficient quantity of land. In the houses of persons of quality likewise, there are pages, called *Itchoglans*, who receive the coffee from the stewards, and present it to the company with surprising dexterity and address, as soon as the master of the family makes a sign for that purpose, which is all the language they ever speak to them. The coffee is served on salvers without feet, made commonly of painted or varnished wood, and sometimes of silver. They hold from 15 to 20 china dishes each; and such as can afford it have these dishes half set in silver. the dish may be easily held with the thumb below and two fingers on the upper edge.

In his *Relation of a Journey to Constantinople in 1657*, Nicholas Rolamb, the Swedish traveler and envoy to the Ottoman Porte, gives us this early glimpse of coffee in the home life of the Turks:

This [coffee] is a kind of pea that grows in *Egypt*, which the *Turks* pound and boil in water, and take it for pleasure instead of brandy, sipping it through the lips boiling hot, persuading themselves that it consumes catarrhs, and prevents the rising of vapours out of the stomach

into the head. The drinking of this coffee and smoking tobacco (for tho' the use of tobacco is forbidden on pain of death, yet it is used in *Constantinople* more than any where by men as well as women, tho' secretly) makes up all the pastime among the *Turks*, and is the only thing they treat one another with; for which reason all people of distinction have a particular room next their own, built on purpose for it, where there stands a jar of coffee continually boiling.<sup>20</sup>

It is curious to note that among several misconceptions that were held by some of the peoples of the Levant was one that coffee was a promoter of impotence, although a Persian version of the Angel Gabriel legend says that Gabriel invented it to restore the Prophet's failing metabolism. Often in Turkish and Arabian literature, however, we meet with the suggestion that coffee drinking makes for sterility and barrenness, a notion that modern medicine has exploded; for now we know that coffee stimulates the racial instinct, for which tobacco is a sedative.

<sup>20</sup> *A Collection of Voyages and Travels*. London, 1745. (vol. iv: p. 690.)

schwache Brülchen/ das Wasser frisch abdehlen/ vnd  
 dartzu dem Bold ein luff zümachen. Wanns einem da-  
 raus zürucken geben/ bietens ihm darneben auch einen  
 Spiegel/ mit der ermanung/ das er sich darinnen ersehe/  
 vnd darbey auch des Todes erinnere: für die güwilligkeit  
 vnd erwehen dienst/ begeren sie nichts/ wirt jnen aber etwas  
 auß freyem willen/ so nehmen sie es zu dank an/ vnd prü-  
 ven alsbald darfür dem jhemigen (ir dankbar gemüt zuer-  
 zügen) das angefecht vnd den bart/ mit einem wolriechens-  
 den wasser/ welches sie in gleycklein auß grossen Tischen/  
 mit vil Weigung spangen beschlagen/ herfür ziehen. Also  
 halten die Türcken vnd Arabes das auch für ein grosses  
 wort der Danckbarkeit vnd liebe/ wann sie ihre Mar-  
 melleamine erög/ vnd ir dine grosse kaffee so ihm vnd wider  
 aussen an den Heußern sehn / täglich lassen mit frisch em  
 Wasser einfallen/ damit wandersleit/ vnd die jhenige aller  
 so durstig seind/ den durst im fürüber gehn/ löschten sönden.  
 Darinnen hangen kleine Kesslein/ auß denen man trinkt.  
 Wann dann jren einer anfange/ gehn andere mehr/ so ihn  
 ersehen/hinzütrinken auch/ oft mehr anderen zugefallen/  
 dann auß durst. Also findet man zu zeiten vber einem Has-  
 sen / bald ein ganze rott besamen sehn / gleich wie der  
 Hund/ die einander in der spür nachgeh: hat einer fern-  
 ner luff/ darzú etwas zuessen/ oder ein anders getrand zu  
 trinken/ so habens gemeinlich darbey auch weite offne  
 Läden/ darinnen sie sich zusamen auff die Erden/ oder das  
 Pfles setzen/ vnd mit einander zechen. Vnder andern ha-  
 bens ein gut getrand/ welches sie hoch halten/ Chaube  
 von jnen geneheet/ das ist gar nahe wie Dinen so schwarz/  
 vnd in gebrechen/ sonderlich des Magens/ gar dienstlich.  
 Dieses pflegen am Morgen früh/ auch an offnen orten/ vor  
 jeders

sedermeynlich ont alles abscheyden zuwenden/ auß ir di-  
 nen vnd Porcellanischen tieffen Schällein/ so warm/ als  
 sie sönden ercheiden/ sendt offt an/ thond aber kleine trin-  
 cklein/ vnd lassens gleich meiter/ wie sie neben einander im  
 Krapp sitzen/ herum gehn. Zu dem wasser neffen sie früche  
 Bannu von jntwohner genemmet/ die aussen in jrer größe  
 vnd farb/ schier wie die Lorbeer/ mit zwap dünne schößlein  
 vmbgeben/ anzusehen/ vnd ferne jhrem alten berichen  
 nach/ auß India gebacht werden. Wie aber die an in selb  
 ring seind/ vnd innen zwen gelbliche söner in zwapen  
 heußlein vnderschiedlich verschlossen haben: zu dem das sie  
 auch mit jhrer würckung/ dem namen vnd ansehen nach/  
 dem Buncho Auic: vnd Buncha Rhasiad Almanf. ganz  
 ehnllich/ halte ichs darfür/ so lang/ bis ich von gelehrten  
 ein besseren berichte einnehme. Dieses trand ist bey ihnen  
 sehr gemain/ darumb dann deren/ so da solches aufschri-  
 cken/ wie auch der Krämer/ so die früche verkauffen/ im Bz-  
 e. zar hin vnd wider nit wenig züfunden: Zu dem/ so haltens  
 das auch wol so hoch vnd gesund sein/ als wir bey jre-  
 gend den Vermütwein/ oder noch andere Kreuterwein w.  
 gleichwol aber nemmens noch darfür den Wein an/ wana  
 sie dorfften jres geseses hab/ wie man dann wol vnder dem  
 Kayser Selymo gesehen/ da er jnen den Wein vergünfiget  
 vnd zügelassen/ wie sie ihn haben getruncken/ das sie nem-  
 lich täglich zusamen kommen/ vnd wanns in zechen bey ei-  
 nander geseßen/ einer dem andern nit nur ein glas oder  
 zwap vol vngemischten starken Weins/ sonder 4 in 5 der  
 Kellein jmal/ wie jnen die von Benedig zupofften/ ha-  
 ben außgebracht/ auch die so bald vnd mit solcher begürde  
 auffeinander außgetrunckē/ das sie jnen (wie ichs zu meh-  
 malen gesehen) nit souil weil genommen/ darzwischen ein  
 bissen

THE FIRST PRINTED REFERENCE TO COFFEE, AS IT APPEARS IN RAUWOLF'S WORK, 1582

## CHAPTER III

### INTRODUCTION OF COFFEE INTO WESTERN EUROPE

WHEN THE THREE GREAT TEMPERANCE BEVERAGES, COCOA, TEA, AND COFFEE, CAME TO EUROPE—COFFEE FIRST MENTIONED BY RAUWOLF IN 1582—EARLY DAYS OF COFFEE IN ITALY—HOW POPE CLEMENT VIII BAPTIZED IT AND MADE IT A TRULY CHRISTIAN BEVERAGE—THE FIRST EUROPEAN COFFEE HOUSE, IN VENICE, 1645—THE FAMOUS CAPPÈ FLORIAN—OTHER CELEBRATED VENETIAN COFFEE HOUSES OF THE EIGHTEENTH CENTURY—THE ROMANTIC STORY OF PEDROCCHI, THE POOR LEMONADE-VENDER, WHO BUILT THE MOST BEAUTIFUL COFFEE HOUSE IN THE WORLD

OF the world's three great temperance beverages, cocoa, tea, and coffee, cocoa was the first to be introduced into Europe, in 1528, by the Spanish. It was nearly a century later, in 1610, that the Dutch brought tea to Europe. Venetian traders introduced coffee into Europe in 1615.

Europe's first knowledge of coffee was brought by travelers returning from the Far East and the Levant. Leonhard Rauwolf started on his famous journey into the Eastern countries from Marseilles in September, 1573, having left his home in Augsburg, the 18th of the preceding May. He reached Aleppo in November, 1573, and returned to Augsburg, February 12, 1576. He was the first European to mention coffee, and to him also belongs the honor of being the first to refer to the beverage in print.

Rauwolf was not only a doctor of medicine and a botanist of great renown, but also official physician to the town of Augsburg. When he spoke, it was as one having authority. The first printed reference to coffee appears as *chaube* in chapter viii of *Rauwolf's Travels*, which deals with the manners and customs of the city of Aleppo. The exact passage is reproduced herewith as it appears in the original German edition of Rauwolf published at Frankfort and Lauingen in 1582-83. The translation is as follows:

If you have a mind to eat something or to drink other liquors, there is commonly an open shop near it, where you sit down upon the ground or carpets and drink together. Among the rest they have a very good drink, by them called *Chaube* [coffee] that is almost as black as ink, and very good in illness, chiefly that of the stomach; of this they drink in the morning early in open places before everybody, without any fear or regard, out of *China* cups, as hot as they can; they put it often to their lips but drink but little at a time, and let it go round as they sit.

In this same water they take a fruit called *Bunnu* which in its bigness, shape and color is almost like unto a bayberry, with two thin shells surrounded, which, as they informed me, are brought from the *Indies*; but as these in themselves are, and have within them, two yellowish grains in two distinct cells, and besides, being they agree in their virtue, figure, looks, and name with the *Bunchum* of *Avicenna*, and *Bunca* of *Rasis ad Almans* exactly; therefore I take them to be the same, until I am better informed by the learned. This liquor is very common among them, wherefore there are a great many of them that sell it, and others that sell the berries, everywhere in their *Batzars*.

#### *The Early Days of Coffee in Italy*

It is not easy to determine just when the use of coffee spread from Constantinople to the western parts of Europe; but it is more than likely that the Venetians, because of their close proximity to, and their great trade with, the Levant, were the first acquainted with it.

Prospero Alpini (Alpinus, 1553-1617), a

learned physician and botanist of Padua, journeyed to Egypt in 1580, and brought back news of coffee. He was the first to print a description of the coffee plant and drink in his treatise *The Plants of Egypt*, written in Latin, and published in Venice, 1592. He says:

I have seen this tree at Cairo, it being the same tree that produces the fruit, so common in Egypt, to which they give the name *bon* or *ban*. The Arabians and the Egyptians make a sort of decoction of it, which they drink instead of wine; and it is sold in all their public houses, as wine is with us. They call this drink *caova*. The fruit of which they make it comes from "Arabia the Happy," and the tree that I saw looks like a spindle tree, but the leaves are thicker, tougher, and greener. The tree is never without leaves.

Alpini makes note of the medicinal qualities attributed to the drink by dwellers in the Orient, and many of these were soon incorporated into Europe's materia medica.

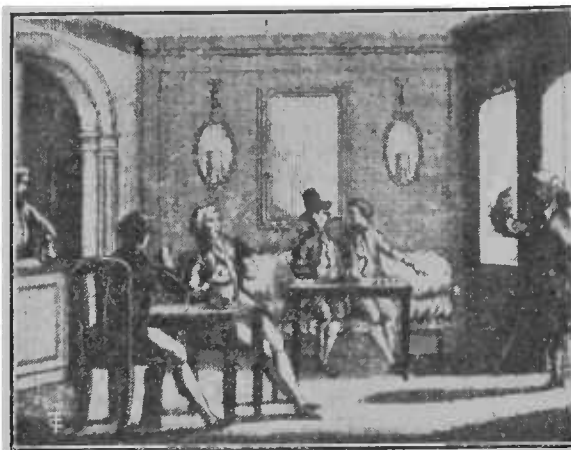
Johann Vesling (Veslingius, 1598-1649), a German botanist and traveler, settled in Venice, where he became known as a learned Italian physician. He edited (1640) a new edition of Alpini's work, but earlier (1638) published some comments on Alpini's findings, in the course of which he distinguished certain qualities found in a drink made from the husks (skins) of the coffee berries from those found in the liquor made from the beans, which he calls the stones of the coffee fruit. He says:

Not only in Egypt is coffee in much request, but in almost all the other provinces of the Turkish Empire. Whence it comes to pass that it is dear even in the Levant and scarce among the Europeans, who by that means are deprived of a very wholesome liquor.

From this we may conclude that coffee was not wholly unknown in Europe at that time. Vesling adds that when he visited Cairo, he found there two or three thousand coffee houses, and that "some did begin to put sugar in their coffee to correct the bitterness of it, and others made sugar-plums of the berries."

#### *Coffee Baptized by the Pope*

Shortly after coffee reached Rome, according to a much quoted legend, it was again threatened with religious fanaticism, which almost caused its excommunication from Christendom. It is related that certain priests appealed to Pope Clement VIII (1535-1605) to have its use forbidden



AN EIGHTEENTH CENTURY ITALIAN COFFEE HOUSE  
After Goldoni, by Zatta

among Christians, denouncing it as an invention of Satan. They claimed that the Evil One, having forbidden his followers, the infidel Moslems, the use of wine—no doubt because it was sanctified by Christ and used in the Holy Communion—had given them as a substitute this hellish black brew of his which they called coffee. For Christians to drink it was to risk falling into a trap set by Satan for their souls.

It is further related that the pope, made curious, desired to inspect this Devil's drink, and had some brought to him. The aroma of it was so pleasant and inviting that the pope was tempted to try a cupful. After drinking it, he exclaimed, "Why, this Satan's drink is so delicious that it would be a pity to let the infidels have exclusive use of it. We shall fool Satan by baptizing it, and making it a truly Christian beverage."

Thus, whatever harmfulness its opponents try to attribute to coffee, the fact remains—if we are to credit the story—that it has been baptized and proclaimed un-harmful, and a "truly Christian beverage," by his holiness the pope.

The Venetians had further knowledge of coffee in 1585, when Gianfrancesco Morosini, city magistrate at Constantinople, reported to the Senate that the Turks "drink a black water as hot as they can suffer it, which is the infusion of a bean called *cavee*, which is said to possess the virtue of stimulating mankind."

Dr. A. Couguet, in an Italian review, asserts that Europe's first cup of coffee was sipped in Venice, toward the close of the sixteenth century. He is of the opin-



ion that the first berries were imported by Mocengio, who was called the *pevere*, because he made a huge fortune trading in spices and other specialties of the Orient.

In 1615 Pierre (Pietro) Della Valle (1586-1652), the well-known Italian traveler and author of *Travels in India and Persia*, wrote a letter from Constantinople to his friend Mario Schipano at Venice:

The Turks have a drink of black color, which during the summer is very cooling, whereas in the winter it heats and warms the body, remaining always the same beverage and not changing its substance. They swallow it hot as it comes from the fire and they drink it in long draughts, not at dinner time, but as a kind of dainty and sipped slowly while talking with one's friends. One cannot find any meetings among them where they drink it not. . . . With this drink, which they call *cahue*, they divert themselves in their conversations. It is made with the grain or fruit of a certain tree called *cahue*. . . . When I return I will bring some with me and I will impart the knowledge to the Italians.

Della Valle's countrymen, however, were



NOBILITY IN AN EARLY VENETIAN CAFÉ  
From the Grevembroch collection in the Museo Civico

in a fair way to become well acquainted with the beverage, for already (1615) it had been introduced into Venice. At first it was used largely for medicinal purposes; and high prices were charged for it. Vesling says of its use in Europe as a medicine, "the first step it made from the cabinets of the curious, as an exotic seed, being into the apothecaries' shops as a drug."

The first coffee house in Italy is said to have been opened in 1645, but convincing confirmation is lacking. In the beginning, the beverage was sold with other drinks by lemonade-venders. The Italian word *aquacedratajo* means one who sells lemonade and similar refreshments; also one who sells coffee, chocolate, liquor, etc. Jardin says the beverage was in general use throughout Italy in 1645. It is certain, however, that a coffee shop was opened in Venice in 1683 under the *Procuratie Nuove*. The famous Caffè Florian was opened in Venice by Floriano Francesconi in 1720.

The first authoritative treatise devoted to coffee only appeared in 1671. It was written in Latin by Antoine Faustus Nairon (1635-1707), Maronite professor of the Chaldean and Syrian languages in the College of Rome.

During the latter part of the seventeenth century and the first half of the eighteenth, the coffee house made great progress in Italy. It is interesting to note that this first European adaptation of the Oriental coffee house was known as a *caffè*. The double *f* is retained by the Italians to this day, and by some writers is thought to have been taken from *coffea*, without the double *f* being lost, as in the case of the French and some other Continental forms.

To Italy, then, belongs the honor of having given to the western world the real coffee house, although the French and Austrians greatly improved upon it. It was not long after its beginning that nearly every shop on the Piazza di San Marco in Venice was a *caffè*.<sup>1</sup> Near the Piazza was the Caffè della Ponte dell' Angelo, where in 1792 died the dog Tabacchio, celebrated by Vincenzo Formaleoni in a satirical eulogy that is a parody of the oration of Ubaldo Bregolini upon the death of Angelo Emo.

In the Caffè della Spaderia, kept by Marco Ancilloto, some radicals proposed to

<sup>1</sup> Molmenti, Pompeo. *La Storia di Venezia nella Vita Privata*. Bergamo, 1908. (pt. 3: p. 245.)



open a reading-room to encourage the spread of liberal ideas. The inquisitors sent a foot-soldier to notify the proprietor that he should inform the first person entering the room that he was to present himself before their tribunal. The idea was thereupon abandoned.

Among other celebrated coffee houses was the one called Menegazzo, from the name of the rotund proprietor, Menico. This place was much frequented by men of letters, and heated discussions were com-



GOLDONI IN A VENETIAN CAFFÈ  
From a painting by P. Longhi

mon there between Angelo Maria Barbaro, Lorenzo da Ponte, and others of their time.

The coffee house gradually became the common resort of all classes. In the mornings came the merchants, lawyers, physicians, brokers, workers, and wandering vendors; in the afternoons, and until the late hours of the nights, the leisure classes, including the ladies.

For the most part, the rooms of the first Italian *caffè* were low, simple, unadorned, without windows, and only poorly illuminated by tremulous and uncertain lights. Within them, however, joyous throngs passed to and fro, clad in varicolored garments, men and women chatting in groups here and there, and always above the buzz

there were to be heard such choice bits of scandal as made worthwhile a visit to the coffee house. Smaller rooms were devoted to gaming.

In the "little square" described by Goldoni in his comedy *The Coffee House*, where the combined barber-shop and gambling house was located, Don Marzio, that marvelous type of slanderous old romancer, is shown as one typical of the period, for Goldoni was a satirist. The other characters of the play were also drawn from the types then to be seen every day in the coffee houses on the Piazza.<sup>2</sup>

In the square of St. Mark's, in the eighteenth century, under the *Procuratie Vecchie*, were the *caffè* Re di Francia, Abbonanza, Pitt. l'eroe, Regina d'Ungheria, Orfeo, Redentore, Coraggio - Speranza, Arco Celeste, and Quadri. The last-named was opened in 1775 by Giorgio Quadri of Corfu, who served genuine Turkish coffee for the first time in Venice.

Under the *Procuratie Nuove* were to be found the *caffè* Angelo Custode, Duca di Toscana, Buon genio-Doge, Imperatore Imperatrice della Russia, Tamerlano, Fontane di Diana, Dame Venete, Aurora Piante d'oro, Arabo - Piastrelle, Pace, Venezia trionfante, and Florian.

Probably no coffee-house in Europe has acquired so world-wide a celebrity as that kept by Florian, the friend of Canova the sculptor, and the trusted agent and acquaintance of hundreds of persons in and out of the city, who found him a mine of social information and a convenient city directory. Persons leaving Venice left their cards and itineraries with him; and new-comers inquired at Florian's for tidings of those whom they wished to see. "He long concentrated in himself a knowledge more varied and multifarious than that possessed by any individual before or since," says Hazlitt, who has given us this delightful pen picture of *caffè* life in Venice in the eighteenth century:

Venetian coffee was said to surpass all others, and the article placed before his visitors by Florian was the best in Venice. Of some of the establishments as they then existed, Molmenti has supplied us with illustrations, in one of which Goldoni the dramatist is represented as a visitor, and a female mendicant is soliciting alms.

So cordial was the esteem of the great sculptor Canova for him, that when Florian was

<sup>2</sup> Goldoni, Carlo. *La Bottega di Caffè*. 1750.



FLORIAN'S FAMOUS CAFFÈ IN THE PIAZZA DI SAN MARCO, VENICE, NINETEENTH CENTURY

overtaken by gout, he made a model of his leg, that the poor fellow might be spared the anguish of fitting himself with boots. The friendship had begun when Canova was entering on his career, and he never forgot the substantial services which had been rendered to him in the hour of need.

In later days, the Caffè Florian was under the superintendence of a female chef, and the waitresses used, in the case of certain visitors, to fasten a flower in the button-hole, perhaps allusively to the name. In the Piazza itself girls would do the same thing. A good deal of hospitality is, and has ever been, dispensed at Venice in the cafés and restaurants, which do service for the domestic hearth.

There were many other establishments devoted, more especially in the latest period of Venetian independence, to the requirements of those who desired such resorts for purposes of conversation and gossip. These houses were frequented by various classes of patrons—the patrician, the politician, the soldier, the artist, the old and the young—all had their special haunts where the company and the tariff were in accordance with the guests. The upper circles of male society—all above the actually poor—gravitated hither to a man.

For the Venetian of all ranks the coffee house was almost the last place visited on departure from the city, and the first visited on his return. His domicile was the residence of his wife and the repository of his possessions; but only on exceptional occasions was it the scene of domestic hospitality, and rare were the instances when the husband and wife might be seen abroad together, and when the former

would invite the lady to enter a café or a confectioner's shop to partake of an ice.<sup>3</sup>

The Caffè Florian has undergone many changes, but it still survives as one of the favorite *caffè* in the Piazza San Marco.

By 1775 coffee-house history had begun to repeat itself in Venice. Charges of immorality, vice, and corruption, were preferred against the *caffè*; and the Council of Ten in 1775, and again in 1776, directed the Inquisitors of State to eradicate these "social cankers." However, they survived all attempts of the reformers to suppress them.

The Caffè Pedrocchi in Padua was another of the early Italian coffee houses that became famous. Antonio Pedrocchi (1776-1852) was a lemonade-vender who, in the hope of attracting the gay youth, the students of his time, bought an old house with the idea of converting the ground floor into a series of attractive rooms. He put all his ready money and all he could borrow into the venture, only to find there were no cellars, indispensable for making ices and beverages on the premises, and that the walls and floors were so old that they crumbled when repairs were started.

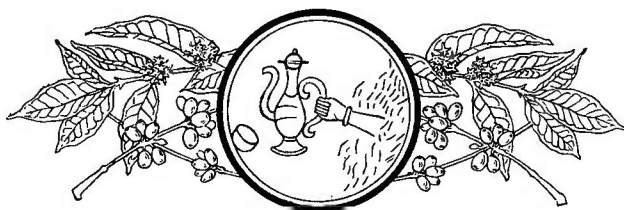
<sup>3</sup> Hazlitt, W. Carew. *The Venetian Republic*. London, 1905. (vol. 2: pp. 1012-15.)

He was in despair ; but, nothing daunted, he decided to have a cellar dug. What was his surprise to find the house was built over the vault of an old church, and that the vault contained considerable treasure. The lucky proprietor found himself free to continue his trade of lemonade-vender and coffee-seller, or to live a life of ease. Being a wise man, he adhered to his original plan ; and soon his luxurious rooms became the favorite rendezvous for the smart set of his day. In this period lemonade and coffee frequently went together. The Caffè Pedrocchi is considered one of the finest pieces of architecture erected in Italy in the nineteenth century. It was begun in 1816, opened in 1831, and completed in 1842.

Coffee houses were early established in other Italian cities, particularly in Rome, Florence, and Genoa.

In 1764, *Il Caffè*, a purely philosophical and literary periodical, made its appearance in Milan, being founded by Count Pietro Verri (1728-97). Its chief editor was Cesare Beccaria. Its object was to counteract the influence and superficiality of the Arcadians. It acquired its title from the fact that Count Verri and his friends were wont to meet at a coffee house in Milan kept by a Greek named Demetrio. It lived only two years.

Other periodicals of the same name appeared at later periods, and, after brief periods of usefulness as propaganda for various cliques, passed into oblivion.



## CHAPTER IV

### THE BEGINNINGS OF COFFEE IN FRANCE

WHAT FRENCH TRAVELERS DID FOR COFFEE—THE INTRODUCTION OF COFFEE BY P. DE LA ROQUE INTO MARSEILLES IN 1644—THE FIRST COMMERCIAL IMPORTATION OF COFFEE FROM EGYPT—THE FIRST FRENCH COFFEE HOUSE—FAILURE OF THE ATTEMPT BY PHYSICIANS OF MARSEILLES TO DISCREDIT COFFEE—SOLIMAN AGA INTRODUCES COFFEE INTO PARIS—CABARETS À CAFFÈ—CELEBRATED WORKS ON COFFEE BY FRENCH WRITERS

WE are indebted to three great French travelers for much valuable knowledge about coffee; and these gallant gentlemen first fired the imagination of the French people in regard to the beverage that was destined to play so important a part in the French revolution. They are Tavernier (1605-89), Thévenot (1633-67), and Bernier (1625-88).

Then there is Jean La Roque (1661-1745), who made a famous "Voyage to Arabia the Happy" (*Voyage de l'Arabie Heureuse*) in 1708-13 and to whose father, P. de la Roque, is due the honor of having brought the first coffee into France in 1644. Also, there is Antoine Galland (1646-1715), the French Orientalist, first translator of the *Arabian Nights* and antiquary to the king, who, in 1699, published an analysis and translation from the Arabic of the Abd-al-Kadir manuscript (1587), giving the first authentic account of the origin of coffee.

Probably the earliest reference to coffee in France is to be found in the simple statement that Onorio Belli (Bellus), the Italian botanist and author, in 1596 sent to Charles de l'Ecluse (1526-1609), a French physician, botanist and traveler, "seeds used by the Egyptians to make a liquid they call *cave*."<sup>1</sup>

P. de la Roque accompanied M. de la Haye, the French ambassador, to Constantinople, and afterward traveled into the

Levant. Upon his return to Marseilles in 1644, he brought with him not only some coffee, but "all the little implements used about it in Turkey, which were then looked upon as great curiosities in France." There were included in the coffee service some fin-djans, or china cups, and small pieces of muslin embroidered with gold, silver, and silk, which the Turks used as napkins.

Jean La Roque gives credit to Jean de Thévenot for introducing coffee privately into Paris in 1657, and for teaching the French how to use coffee.

De Thévenot writes in this entertaining fashion concerning the use of the drink in Turkey in the middle of the seventeenth century:

They have another drink in ordinary use. They call it *cahve* and take it all hours of the day. This drink is made from a berry roasted in a pan or other utensil over the fire. They pound it into a very fine powder.

When they wish to drink it, they take a boiler made expressly for the purpose, which they call an *ibrik*; and having filled it with water, they let it boil. When it boils, they add to about three cups of water a heaping spoonful of the powder; and when it boils, they remove it quickly from the fire, or sometimes they stir it, otherwise it would boil over, as it rises very quickly. When it has boiled up thus ten or twelve times, they pour it into porcelain cups, which they place upon a platter of painted wood and bring it to you thus boiling.

One must drink it hot, but in several instalments, otherwise it is not good. One takes it in little swallows<sup>2</sup> for fear of burning one's self—in such fashion that in a *cavekane* (so they call the places where it is sold ready prepared), one

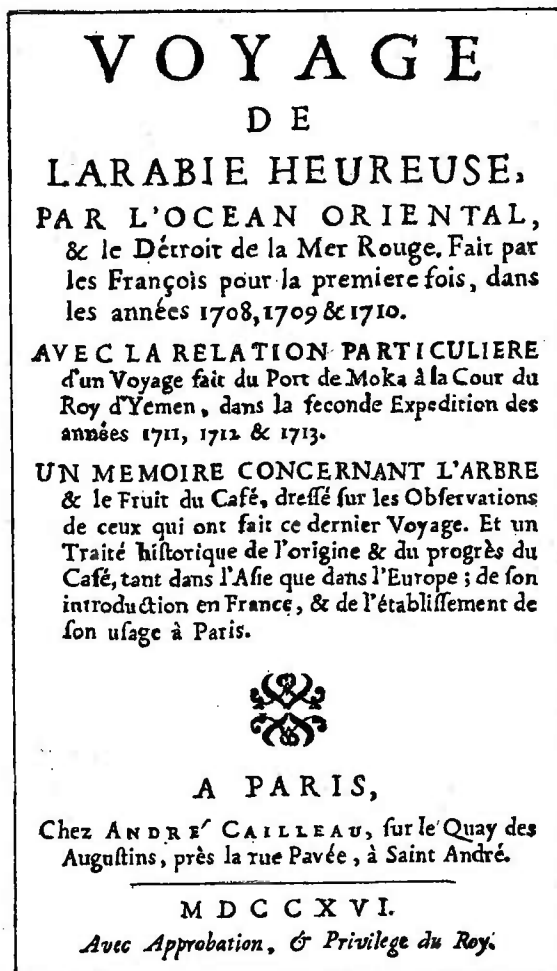
<sup>1</sup> Jardin, Édelestan. *Le Cafétier et le Café*. Paris, 1895. (p. 16.)

<sup>2</sup> "Drop by drop they take it in," said Cotovleus.

hears a pleasant little musical sucking sound.

There are some who mix with it a small quantity of cloves and cardamom seeds; others add sugar.

It was really out of curiosity that the people of France took to coffee, says Jar-



TITLE PAGE OF LA ROQUE'S WORK, 1716:  
THE STORY OF THE AUTHOR'S JOURNEY TO THE  
COURT OF THE KING OF YEMEN

din; "they wanted to know this Oriental beverage, so much vaunted, although its blackness at first sight was far from attractive."

About the year 1660 several merchants of Marseilles, who had lived for a time in the Levant and felt they were not able to do without coffee, brought some coffee beans home with them; and later, a group of apothecaries and other merchants brought in the first commercial importation of coffee in bales from Egypt. The Lyons merchants soon followed suit, and the use of

coffee became general in those parts. In 1671 certain private persons opened a coffee house in Marseilles, near the Exchange, which at once became popular with merchants and travelers. Others started up, and all were crowded. The people did not, however, drink any the less at home. "In fine," says La Roque, "the use of the beverage increased so amazingly that, as was inevitable, the physicians became alarmed, "thinking it would not agree with the inhabitants of a country hot and extremely dry."

The age-old controversy was on. Some sided with the physicians, others opposed them, as at Mecca, Cairo, and Constantinople; only here the argument turned mainly on the medicinal question, the Church this time having no part in the dispute. "The lovers of coffee used the physicians very ill when they met together,



THE COFFEE TREE AS PICTURED BY LA ROQUE IN  
HIS "VOYAGE DE L'ARABIE HEUREUSE"

and the physicians on their side threatened the coffee drinkers with all sorts of diseases."

Matters came to a head in 1679, when an ingenious attempt by the physicians of Marseilles to discredit coffee took the form of having a young student, about to be ad-

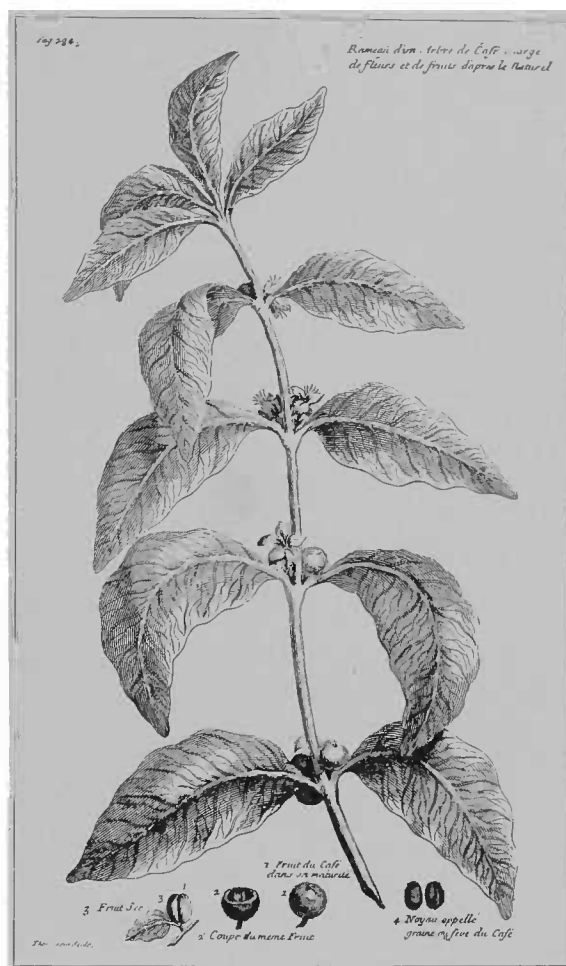
mitted to the College of Physicians, dispute before the magistrate in the town hall, a question proposed by two physicians of the Faculty of Aix, as to whether coffee was or was not prejudicial to the inhabitants of Marseilles.

The thesis recited that coffee had won the approval of all nations, had almost wholly put down the use of wine, although it was not to be compared even with the lees of that excellent beverage; that it was a vile and worthless foreign novelty; that its claim to be a remedy against distempers was ridiculous, because it was not a bean but the fruit of a tree discovered by goats and camels; that it was hot and not cold, as alleged; that it burned up the blood, and so induced palsies, impotence, and leanness; "from all of which we must necessarily conclude that coffee is hurtful to the greater part of the inhabitants of Marseilles."

Thus did the good doctors of the Faculty of Aix set forth their prejudices, and this was their final decision upon coffee. Many thought they overreached themselves in their misguided zeal. They were handled somewhat roughly in the disputation, which disclosed many false reasonings, to say nothing of blunders as to matters of fact. The world had already advanced too far to have another decision against coffee count for much, and this latest effort to stop its onward march was of even less force than the diatribes of the Mohammedan priests. The coffee houses continued to be as much frequented as before, and the people drank no less coffee in their homes. Indeed, the indictment proved a boomerang, for consumption received such an impetus that the merchants of Lyons and Marseilles, for the first time in history, began to import green coffee from the Levant by the ship-load in order to meet the increased demand.

Meanwhile, in 1669, Soliman Aga, the Turkish ambassador from Mohammed IV to the court of Louis XIV. had arrived in Paris. He brought with him a considerable quantity of coffee, and introduced the coffee drink, made in Turkish style, to the French capital.

The ambassador remained in Paris only from July, 1669, to May, 1670, but long enough firmly to establish the custom he had introduced. Two years later, Pascal, an Armenian, opened his coffee-drinking booth at the fair of St. Germain, and this event marked the beginning of the Parisian



A COFFEE BRANCH WITH FLOWERS AND FRUIT AS ILLUSTRATED IN LA ROQUE'S "VOYAGE DE L'ARABIE HEUREUSE"

coffee houses. The story is told in detail in chapter X.

The custom of drinking coffee having become general in the capital, as well as in Marseilles and Lyons, the example was followed in all the provinces. Every city soon had its coffee houses, and the beverage was largely consumed in private homes. La Roque writes: "None, from the meanest citizen to the persons of the highest quality, failed to use it every morning or at least soon after dinner, it being the custom likewise to offer it in all visits."

"The persons of highest quality" encouraged the fashion of having *cabarets à caffè*; and soon it was said that there could be seen in France all that the East could furnish of magnificence in coffee houses, "the china jars and other Indian furniture being richer and more valuable than the gold and silver with which they were lavishly adorned."



In 1671 there appeared in Lyons a book entitled *The Most Excellent Virtues of the Mulberry, Called Coffee*, showing the need for an authoritative work on the subject—a need that was ably filled that same year and in Lyons by the publication of Philippe Sylvestre Dufour's admirable treatise, *Concerning the Use of Coffee, Tea, and Chocolate*. Again at Lyons, Dufour published (1684) his more complete work on *The Manner of Making Coffee, Tea, and Chocolate*. This was followed (1715) by the publication in Paris of Jean La Roque's *Voyage de l'Arabie Heureuse*, containing the story of the author's journey to the court of the King of Yemen in 1711, a description of the coffee tree and its fruit, and a critical and historical treatise on its first use and introduction to France.

La Roque's description of his visit to the king's gardens is interesting because it shows the Arabs still held to the belief that coffee grew only in Arabia. Here it is:

There was nothing remarkable in the King's Gardens, except the great pains taken to furnish it with all the kinds of trees that are common in the country; amongst which there were the coffee trees, the finest that could be had. When the deputies represented to the King how much that was contrary to the custom of the Princes of Europe (who endeavor to stock their gardens chiefly with the rarest and most uncommon plants that can be found) the King returned

them this answer: That he valued himself as much upon his good taste and generosity as any Prince in Europe; the coffee tree, he told them, was indeed common in his country, but it was not the less dear to him upon that account; the perpetual verdure of it pleased him extremely; and also the thoughts of its producing a fruit which was nowhere else to be met with; and when he made a present of that that came from his own Gardens, it was a great satisfaction to him to be able to say that he had planted the trees that produced it with his own hands.

The first merchant licensed to sell coffee in France was one Damame François, a bourgeois of Paris, who secured the privilege through an edict of 1692. He was given the sole right for ten years to sell coffee and teas in all the provinces and towns of the kingdom, and in all territories under the sovereignty of the king, and received also authority to maintain a warehouse.

To Santo Domingo (1738) and other French colonies the café was soon transported from the homeland, and thrived under special license from the king.

In 1858 there appeared in France a leaflet-periodical, entitled *The Café, Literary, Artistic, and Commercial*. Ch. Woinez, the editor, said in announcing it: "The Salon stood for privilege, the Café stands for equality." Its publication was of short duration.



## CHAPTER V

### THE INTRODUCTION OF COFFEE INTO ENGLAND

THE FIRST PRINTED REFERENCE TO COFFEE IN ENGLISH—EARLY MENTION OF COFFEE BY NOTED ENGLISH TRAVELERS AND WRITERS—THE LACEDÆMONIAN “BLACK BROTH” CONTROVERSY—HOW CONOPIOS INTRODUCED COFFEE DRINKING AT OXFORD—THE FIRST ENGLISH COFFEE HOUSE IN OXFORD—TWO ENGLISH BOTANISTS DISCUSS COFFEE—JOHN PARKINSON PUBLISHES THE EARLIEST BOTANICAL DESCRIPTION OF THE PLANT AND JOHN RAY EXTOLS THE BEVERAGE

ENGLISH travelers and writers of the sixteenth and seventeenth centuries were quite as enterprising as their Continental contemporaries in telling about the coffee bean and the coffee drink. The first printed reference to coffee in English, however, appears as *chaoua* in a note by a Dutchman, Paludanus, in *Linschooten's Travels*, the title of an English translation from the Latin of a work first published in Holland in 1595 or 1596, the English edition appearing in London in 1598. A reproduction made from a photograph of the original work, with the quaint black-letter German text and the Paludanus notation in roman, is shown on page 32.

Hans Hugo (or John Huygen) Van Linschooten (1563-1611) was one of the most intrepid of Dutch travelers. In his description of Japanese manners and customs we find one of the earliest tea references. He says:

Their manner of eating and drinking is: everie man hath a table alone, without table-clothes or napkins, and eateth with two pieces of wood like the men of Chino: they drinke wine of Rice, wherewith they drink themselves drunke, and after their meat they use a certain drinke, which is a pot with hote water, which they drinke as hote as ever they may indure, whether it be Winter or Summer.

Just here Bernard Ten Broeke Paludanus (1550-1633), Dutch savant and author, professor of philosophy at the University of Leyden, himself a traveler over the four quarters of the globe, inserts his note containing the coffee reference. He says:

The Turks holde almost the same manner of drinking of their *Chaona*,<sup>1</sup> which they make of certaine fruit, which is like unto the Bakelaer,<sup>2</sup> and by the Egyptians called *Bon* or *Ban*:<sup>3</sup> they take of this fruite one pound and a half, and roast them a little in the fire and then sieth them in twenty pounds of water, till the half be consumed away: this drinke they take every morning fasting in their chambers, out of an earthen pot, being verie hote, as we doe here drinke *aquacomposita*<sup>4</sup> in the morning: and they say that it strengtheneth and maketh them warme, breaketh wind, and openeth any stop-ping.

Van Linschooten then completes his tea reference by saying:

The manner of dressing their meat is altogether contrarie unto other nations: the aforesaid warme water is made with the powder of a certaine hearbe called *Chaa*, which is much esteemed, and is well accounted among them.

The *chaa* is, of course, tea, dialect *t'eh*.

In 1599, “Sir” Antony (or Anthony) Sherley (1565-1630), a picturesque gentleman-adventurer, the first Englishman to mention coffee drinking in the Orient, sailed from Venice on a kind of self-appointed, informal Persian mission, to invite the shah to ally himself with the Christian princes against the Turks, and incidentally, to promote English trade interests in the East. The English government knew nothing of the arrangement, disavowed him, and forbade his return to England. However, the

<sup>1</sup> Misprinted thus in the original Dutch and here. Read *Chaoua*, i. e., Arabic *gahwak*.

<sup>2</sup> Laurel berry, of which the taste is bitter and disagreeable. From Latin *bacca lauri*.

<sup>3</sup> Arabic, *bunn*; coffee berries.

<sup>4</sup> *Brandewijn* in original Dutch.

our clothes when we meane to goe abroad into the towne or countrie, they put them off when they goe forth, putting on great wyde breeches, and coming home they put them off again, and cast their clothes upon their shoulders: and as among other nations it is a good sight to see men with white and pealow haire and white teeth, with them it is esteemed the filthiest thing in the world, and seeke by all means they may to make their haire and teeth blacke, for that the white causeth their grief, and the blacke maketh them glad. The like custome is among the women, for as they goe abroad they haue their daughters & maydes befoze them, and their men seruants come behind, which in Spaigne is cleane contrary, and when they are great with childe, they tie their girdles so hard about them, that men would thinke they shuld burst, and when they are not with Childe, they weare their girdles so loose, that you would thinke they would fall from their bodies, saying that by experience they do finde, if they should not doe so, they should haue euill lucke with their fruit, and presently as soone as they are deliuered of their children, instead of christning both the mother and the child with some comfortable meate, they presently wash the childe in cold water, and for a time giue the mother very little to eate, and that of no great substance. Their manner of eating and drinking is: Cuertie man hath a table alone, without table-clothes or napkins, and eateth with two peeces of wood, like the men of China: they drinke wine of Rice, wherewith they drinke themselves drunke, and after their meate they use a certaine drinke, which is a pot with hote water, which they drinke as hote as euer they may indure, whether it be Winter or Summer.

Annotat.  
D. Pall.

The Turkes holde almost the same manner of drinking of their *Chaona*, which they make of certaine fruit, which is like vnto the *Bakelaer*, and by the *Egyptians* called *Ban* or *Ban*: they take of this fruit one pound and a half, and roast them a little in the fire, and then sieth them in twentie poundes of water, till the half be consumed away: this drinke they take euerie morning, sitting in their chambers, out of an earthen pot, being verie hote, as we doe here drinke *ayracomposita* in the morning: and they say that it strengtenth and maketh them warme, breaketh wind, and openeth any stopping.

The manner of dressing their meat is altogether contrary vnto other nations: the aforesaid warme water is made with the powder of a certaine heerbe called *Chaa*, which is much esteemed, and is well accounted of  
The 1. Booke.

among them, and all such as are of any countenance or habilitie haue the said water kept for them in a secret place, and the gentlemen make it themselves, and when they will entertaine any of their friends, they giue him some of that warme water to drinke: for the pots wherein they sieth it, and wherein the hearbe is kept, with the earthen cups which they drinke it in, they esteeme as much of them, as we doe of Diamonds, Rubies and other precious stones, and they are not esteemed for their newnes, but for their oltnes, and for that they were made by a good workman: and to know and keepe such by themselves, they take great and speciall care, as also of such as are the valetuers of them, and are skilfull in them, as with vs the goldsmith priset and valuet silver and gold, and the Jewellers all kindes of precious stones: so if their pots & cuppes be of an old & excellent workmans making, they are worth 4 or 5 thousand ducats or moze the pece. The King of Bungo did giue for such a pot, hauing three feet, 14 thousand ducats, and a Iapan being a Christian in the towne of Sacay, gaue for such a pot 1400 ducats, and yet it had 3 peeces vpon it. They doe likewise esteeme much of any picture or table, wherein is painted a blacke tree, or a blacke bird, and when they knowe it is made of wood, and by an ancient & cunning maister, they giue whatsoeuer you will aske for it. It happeneth some times that such a picture is sold for 3 or 4 thousand ducats and moze. They also esteeme much of a good rapier, made by an old and cunning maister, such a one many times costeth 3 or 4 thousand Crowns the pece. These things doe they keepe and esteeme for their Jewels, as we esteeme our Jewels & precious stones: And when we aske them why they esteeme them so much, they aske vs againe, why we esteeme so well of our precious stones & Jewels, whereby there is not any profite to be had, and serue to no other vse, then only for a shewe, & that their things serue to some end.

Their Justice and government is as follows: Their Kings are called Iacatay, and are absolutely Lords of the land, notwithstanding they keepe for themselves as much as is necessary for their and their estate, and the rest of their land they buye among others, which are called *Cunixus*, which are like our *Carles* and *Dukes*: these are appointed by the King, and he causeth them to gouerne & rule the land as it pleaseth him: they are bound to serue the King as well in peace, as in warres, at their owne cost & charges, according to their estate, and the ancient lawes of Iapan. These *Cunixus* haue others vnder them called *Toms*, which are like our  
Lords

FIRST PRINTED REFERENCE TO COFFEE IN ENGLISH, 1598  
It appears as *Chaona* (*chaoua*) in the second line of the roman text notation by Paludanus

expedition got to Persia, and the account of the voyage thither was written by William Parry, one of the Sherley party. It was published in London in 1601 and is interesting because it contains the first printed reference to coffee in English employing the more modern form of the word. The original reference was photographed for this work in the Worth Library of the British Museum, and is reproduced herewith on page 34.

The passage is part of an account of the manners and customs of the Turks—who, Parry says, are “damned infidells”—in Aleppo. It reads:

They sit at their meat (which is served to them upon the ground) as Tailors sit upon their stalls, crosse-legd; for the most part, passing the day in banqueting and carousing, untill they surfet, drinking a certaine liquor, which they do call *Coffe*, which is made of seede much like mustard seede, which will soone intoxicate the braine like our Metheglin.<sup>5</sup>

Another early English reference to coffee, wherein the word is spelled “*coffa*,” is in Captain John Smith’s book of *Travels and Adventure*, published in 1603. He says of the Turks: “Their best drink is *coffa* of a graine they call *coava*.”

This is the same Captain John Smith who in 1607 became the founder of the Colony of Virginia and brought with him to America probably the earliest knowledge of the beverage given to the new Western world.

Samuel Purchas (1527-1626), an early English collector of travels, in *Purchas His Pilgrimes*, under the head of “Observations of William Finch, merchant at Socotra” (Sokotra—an island in the Indian Ocean) in 1607, says of the Arab inhabitants:

Their best entertainment is a china dish of *Coho*, a blacke bitterish drinke, made of a berry like a bayberry, brought from Mecca, supped off hot, good for the head and stomache.

Still other early and favorite English references to coffee are those to be found in the *Travels* of William Biddulph. This work was published in 1609. It is entitled *The Travels of Certayne Englishmen in Africa, Asia, etc. . Begunne in 1600 and by some of them finished—this yeere 1608*. These references are also reproduced herewith from the black-letter originals in the British Museum (see page 36).

Biddulph’s description of the drink, and of the coffee-house customs of the Turks,

was the first detailed account to be written by an Englishman. It also appears in *Purchas His Pilgrimes* (1625). But, to quote:

Their most common drinke is *Coffa*, which is a blacke kinde of drinke, made of a kind of Pulse like Pease, called *Coava*; which being grownd in the Mill, and boiled in water, they drinke it as hot as they can suffer it; which they finde to agree very well with them against their crudities, and feeding on hearbs and rawe meates. Other compounded drinks they have, called *Sherbet*, made of Water and Sugar, or Hony, with Snow therein to make it coole; for although the Countrey bee hot, yet they keepe Snow all the yeere long to coole their drinke. It is accounted a great curtesie amongst them to give unto their frends when they come to visit them, a Fin-ion or Scudella of *Coffa*, which is more holesome than toothsome, for it causeth good concoction, and driveth away drowsinesse.

Some of them will also drinke Bersh or Opium, which maketh them forget themselves, and talk idely of Castles in the Ayre, as though they saw Visions, and heard Revelations. Their *Coffa* houses are more common than Ale-houses in England; but they use not so much to sit in the houses, as on benches on both sides the streets, neere unto a *Coffa* house, every man with his Fin-ionful; which being smoking hot, they use to put it to their Noses & Eares, and then sup it off by leasure, being full of idle and Ale-house talke whiles they are amongst themselves drinking it; if there be any news, it is talked of there.

Among other early English references to coffee we find an interesting one by Sir George Sandys (1577-1644), the poet, who gave a start to classical scholarship in America by translating Ovid’s *Metamorphoses* during his pioneer days in Virginia. In 1610 he spent a year in Turkey, Egypt, and Palestine, and records of the Turks:

Although they be destitute of Taverns, yet have they their *Coffa*-houses, which something resemble them. There sit they chatting most of the day; and sippe of a drinke called *Coffa* (of the berry that it is made of) in little *China* dishes as hot as they can suffer it: blacke as soote, and tasting not much unlike it (why not that blacke broth which was in use amongst the *Lacedæmonians*?) Which helpeth, as they say, digestion, and procureth alacrity: many of the *Coffa*-men keeping beautifull boyes, who serve as stales to procure them customers.<sup>6</sup>

Edward Terry (1590-1660), an English traveler, writes under date of 1616, that many of the best people in India who are strict in their religion and drink no wine at all, “use a liquor more wholesome than pleasant, they call coffee; made by a black Seed boyled in water, which turnes it almost

<sup>5</sup> Mead.

<sup>6</sup> Sandys, Sir George. *Sandy’s Travels*. London, 1673. (p. 66.)

### Sir Antonie Sherlies

which was granted by the Barrow, with his Passé, together with the English Consuls and vice-consuls.

Leaving here able to prosecute our journey, I will speake somewhat of the fashion and disposition of the people and country, whose behaviours in point of civilitie (besides that they are damned Infidells, and Zodo-niticall Idolaters) doe answer the hate we christians doe justly bestow upon them in. For they are beyond all measure a most insolent impertinent and insulting people, ever more prest to offer outrage to any christian, if he be not well guarded with a Janizarie, or Janizaries. They sit at their meat, which is served to them upon the ground as Waiters sit upon their stalls, cross-legged: for the most part, passing the day in banqueting and carousing, until they have drunk a certaine liquor, which they do call Coffe, which is made of a seede much like unto that of the figg. They will not permitt any christian to come within their churches, for they holde their profane and irreligious Sermonies desired thereby. They have no use of Bibles, but some priest three times in the day, mounts the toppe of their church, and there, with an exalted voyce cries out, and invokes Spahomet to come in post, for they have long expected his second coming. And without this are yeeres (as they say) he come not (being the best time of his appointment and promise made in that behalfe) they have no hope of his coming. But they feare (according to a prophete they have) the Christians at the end thereof shall subvert their all, and convert them to christiantie. They have twines in number according to their wealth, five, three, four, or upwards, according as they are in ability furnished to maintain themselves. But women are for the most part very bare, and bed coverles, and death is for aunc christians easie to know them, which were they had

### Travelles.

ing to doe hardly could they attaine it, because they are easily charmed by bottles it be at such time as they go to their ballones, or to the Spanes, to be waile their dead (as their manner is) which once a while usually they doe, and then shall no part of them be discovered neither, but only their eyes, except it be by a great chance. The country aboundeth with great fozes of all kinds of fruit, whereupon (for the most parte) they live, their chief meate being Mice. Their fleshy is Buffon and Venues; which Buffons have huge byade fatte tails. This meate most commonly they have but once in the day, all the rest, they eate fruite as aforesaide. They eate very little becke, unless it be the poorest sort, Camels; for their carriage they have in great abundance; but when both them and their horses are past the best, and brist for carriage, the poorest of their people eate them.

They have one thing most usual among them, which though it be right but knowne to all of our Nation that knowe Turkie, yet it exceedeth the credite of our home-bred countreymen, for relating whereof (perhaps) I may be held a liar, having authority so to doe (as they say and thinke) because I am a traveller. But the truth thereof being knowne to all our Englishmen that trade or travel into these partes, is a want of omniscient for the report, howe repugnant sooner it be to the beleefe of our English multitude.

And this it is, when they desire to heare newes, or intelligence out of any remote parts of their country with all certaintie (as we say, upon the wings of the winde) they have pigeons that are so taught and brought to the hand, that they will flie with Letters (fastened with a string about their bodies under their wings) containing all the intelligence of occurrences, or what else is to be expected from those partes: from whence, if they should be sent by camells (so; so otherwise they must) they should

not

into the same colour, but doth very little alter the taste of the water [!], notwithstanding it is very good to help Digestion, to quicken the Spirits and to cleanse the Blood."

In 1623, Francis Bacon (1561-1626), in his *Historia Vitae et Mortis* says: "The Turkes use a kind of herb which they call *caphe*"; and, in 1624, in his *Sylva Sylvarum* (published in 1627, after his death), he writes:

They have in Turkey a drink called *coffa* made of a berry of the same name, as black as soot, and of a strong scent, but not aromatical; which they take, beaten into powder, in water, as hot as they can drink it: and they take it, and sit at it in their coffa-houses, which are like our taverns. This drink comforteth the brain and heart, and helpeth digestion. Certainly this berry coffa, the root and leaf betel, the leaf tobacco, and the tear of poppy (opium) of which the Turks are great takers (supposing it expelleth all fear), do all condense the spirits, and make them strong and aleger. But it seemeth they were taken after several manners; for coffa and opium are taken down, tobacco but in smoke, and betel is but champed in the mouth with a little lime.<sup>7</sup>

Robert Burton (1577-1640), English philosopher and humorist, in his *Anatomy of Melancholy* writes in 1632:

The Turkes have a drinke called coffa (for they use no wine), so named of a berry as blacke as soot and as bitter (like that blacke drinke which was in use amongst the Lacedaemonians and perhaps the same), which they sip still of, and sup as warme as they can suffer; they spend much time in those coffa-houses, which are somewhat like our Ale-houses or Taverns, and there they sit, chatting and drinking, to drive away the time, and to be merry together, because they find, by experience, that kinde of drinke so used, helpeth digestion and procureth alacrity.<sup>8</sup>

Later English scholars, however, found sufficient evidence in the works of Arabian authors to assure their readers that coffee sometimes breeds melancholy, causes headache, and "maketh lean much." One of these, Dr. Pococke (1659): see chapter II), stated that, "he that would drink it for liveliness sake, and to discusse slothfulness let him use much sweet meates with it, and oyle of pistaccioes, and butter. Some drink it with milk, but it is an error, and such as may bring in danger of the leprosy." Another writer observed that any ill effects caused by coffee, unlike those

of tea, etc., ceased when its use was discontinued. In this connection it is interesting to note that in 1785 Dr. Benjamin Mosely, physician to the Chelsea Hospital, member of the College of Physicians, etc., probably having in mind the popular idea that the Arabic original of the word coffee meant force, or vigor, once expressed the hope that the coffee drink might return to popular favor in England as "a cheap substitute for those enervating teas and beverages which produce the pernicious habit of dram-drinking."

About 1628, Sir Thomas Herbert (1606-1681), English traveler and writer, records among his observations on the Persians that:

They drink above all the rest *Coho* or *Copha*: by Turk and Arab called *Caphe* and *Cahua*: a drink imitating that in the Stigian lake, black, thick, and bitter: destrain'd from *Bunchy*, *Bunnu*, or Bay berries; wholesome, they say, if hot, for it expels melancholy but not so much regarded for those good properties, as from a Romance that it was invented and brew'd by Gabriel . . . to restore the decayed radical Moysture of kind hearted Mahomet.<sup>9</sup>

In 1634, Sir Henry Blount (1602-82), sometimes referred to as "the father of the English coffee house," made a journey on a Venetian galley into the Levant. He was invited to drink *cauphe* in the presence of Amurath IV; and later, in Egypt, he tells of being served the beverage again "in a porcelaine dish". This is how he describes the drink in Turkey:

They have another drink not good at meat, called *Cauphe*, made of a *Berry* as big as a small *Bean*, dried in a Furnace, and beat to Pouders, of a Soot-colour, in taste a little bitterish, that they seeth and drink as hot as may be endured: It is good all hours of the day, but especially morning and evening, when to that purpose, they entertain themselves two or three hours in *Cauphe-houses*, which in all Turkey abound more than *Inns* and *Ale-houses* with us; it is thought to be the old black broth used so much by the *Lacedaemonians*, and dryeth ill Humours in the stomach, comforteth the Brain, never causeth Drunkenness or any other Surfeit, and is a harmless entertainment of good Fellowship; for there upon Scaffolds half a yard high, and covered with Mats, they sit Cross-leg'd after the *Turkish* manner, many times two or three hundred together, talking, and likely with some poor musick passing up and down.<sup>10</sup>

This reference to the Lacedaemonian black broth, first by Sandys, then by Bur-

<sup>7</sup> Bacon, Francis. *Sylva Sylvarum*. London, 1627. (vol. v: p. 26.)

<sup>8</sup> Burton, Robert. *The Anatomy of Melancholy*. Oxford, 1632. (pt. 2: sec. 5: p. 397.) This reference does not appear in the earlier editions, 1621, 24, 28.

<sup>9</sup> Herbert, Sir. T. *Travels*. London, ed. 1638. (p. 241.)

<sup>10</sup> Blount, Sir Henry. *A Voyage Into the Levant*. London, 1671. (pp. 20, 21, 54, 55, 138, 139.)



ton, again by Blount, and concurred in by James Howell (1595-1666), the first historiographer royal, gave rise to considerable controversy among Englishmen of letters in later years. It is, of course, a gratuitous speculation. The black broth of the Lacedæmonians was "pork, cooked in blood and seasoned with salt and vinegar."<sup>11</sup>

Although it seems likely that coffee must have been introduced into England sometime during the first quarter of the seventeenth century, with so many writers and travelers describing it, and with so much trading going on between the merchants of the British Isles and the Orient, yet the first reliable record we have of its advent

**Their most common drinke is Coffa, which is a blacke kind of drinke made of a kind of Pulse like Pease, called Coaua; which being grownd in the mill, and boiled in water, they drinke it as hot as they can suffer it; which they find to agree very well with them against their crudities and feeding on heards and rawe meates.**

**It is accounted a great curtesie amongst them to give unto their friends when they come to visit them, a fin-ion of Scudella of Coffa, which is moze wholesome than toothsome, for it causeth good concoction, and driueth away drowlinesse.**

**Their Coffa houses are moze common than Ale-houses in England; but they vse not so much to sit in the houses as on benches on both sides the streets neere unto a Coffa house, euery man with his fin-ion full; which being smoking hot, they vse to put it to their noses & eares, and then sup it off by leasure, being full of idle and Ale-house talke whiles they are amongst themselves drinkeing of it; if there be any news, it is talked of there.**

REFERENCES TO COFFEE AS FOUND IN BIDDULPH'S TRAVELS 1609  
From the black-letter original in the British Museum

William Harvey (1578-1657), the famous English physician who discovered the circulation of the blood, and his brother are reputed to have used coffee before coffee houses came into vogue in London—this must have been previous to 1652. "I remember," says Aubrey, "he was wont to drinke coffee; which his brother Eliab did, before coffee houses were the fashion in London."<sup>12</sup> Houghton, in 1701, speaks of "Dr. Harvey, who some say did frequently use it."

<sup>11</sup> Gilbert, Gustav. *The Constitutional Antiquities of Sparta and Athens*. London, 1895. (p. 69.)

<sup>12</sup> Aubrey, John. *Lives of Eminent Men*. London, 1813. (vol. ii: pt. 2: pp. 384-85.)

is to be found in the *Diary and Correspondence of John Evelyn, F. R. S.*, under "Notes of 1637," where he says:

There came in my time to the college (Baliol, Oxford) one Nathaniel Conopios, out of Greece, from Cyrill, the Patriarch of Constantinople, who, returning many years after was made (as I understand) Bishop of Smyrna. He was the first I ever saw drink coffee; which custom came not into England till thirty years thereafter.<sup>13</sup>

Evelyn should have said thirteen years after; for then it was that the first coffee house was opened (1650).

Conopios was a native of Crete, trained

<sup>13</sup> Evelyn, John. *Works*. Vol. iv: p. 389.

in the Greek church. He became *primore* to Cyrill, Patriarch of Constantinople. When Cyrill was strangled by the vizier, Conopios fled to England to avoid a like barbarity. He came with credentials to Archbishop Laud, who allowed him maintenance in Balliol College.

It was observed that while he continued in Balliol College he made the drink for his own use called Coffey, and usually drank it every morning, being the first, as the antients of that House have informed me, that was ever drank in Oxon.<sup>14</sup>

In 1640 John Parkinson (1567-1650), English botanist and herbalist, published



MOL'S COFFEE HOUSE EXETER, ENGLAND,  
NOW WORTH'S ART ROOMS

his *Theatrum Botanicum*, containing the first botanical description of the coffee plant

<sup>14</sup> Wood, Anthony. *Athenae Oxonienses*. London, 1692. (vol. II: col. 658.)

in English, referred to as "*Arbor Bon cum sua Buna*. The Turks Berry Drink."

His work being somewhat rare, it may be of historical interest to quote it here:

Alpinus, in his Booke of Egiptian plants, giveth us a description of this tree, which as hee saith, hee saw in the garden of a certain Capitaine of the *Ianissaries*, which was brought out of *Arabia felix* and there planted as a rarity, never seene growing in those places before.

The tree, saith *Alpinus*, is somewhat like unto the *Evonymus* Pricketimber tree; whose leaves were thicker, harder, and greener, and always abiding greene on the tree; the fruite is called *Buna* and is somewhat bigger then an Hazell Nut and longer, round also, and pointed at the end, furrowed also on both sides, yet on one side more conspicuous than the other, that it might be parted in two, in each side whereof lyeth a small long white kernell, flat on that side they joyne together, covered with a yellowish skinne, of an acid taste, and somewhat bitter withall and contained in a thinne shell, of a darkish ash-color; with these berries generally in *Arabia* and *Egipt*, and in other places of the *Turkes* Dominions, they make a decoction or drinke, which is in the stead of Wine to them, and generally sold in all their tappe houses, called by the name of *Caova*; *Paludanus* saith *Chaova*, and *Rauwolfius Chaube*.

This drinke hath many good physical properties therein; for it strengtheneth a weak stomacke, helpeth digestion, and the tumors and obstructions of the liver and spleene, being drunke fasting for some time together.<sup>15</sup>

In 1650, a certain Jew from Lebanon, in some accounts Jacob or Jacobs by name, in others Jobson, opened "at the Angel in the parish of St. Peter in the East," Oxford, the earliest English coffee house and "there it [coffee] was by some who delighted in noveltie, drank." Chocolate was also sold at this first coffee house.<sup>16</sup>

Authorities differ, but the confusion as to the name of the coffee-house keeper may have arisen from the fact that there were two Jacobses; one who began in 1650, and another, Cirques Jobson, a Jewish Jacobite, who followed him in 1654.

The drink at once attained great favor among the students. Soon it was in such demand that about 1655 a society of young students encouraged one Arthur Tillyard, "apothecary and Royalist," to sell "coffey publicly in his house against All Soules College." It appears that a club composed of admirers of the young Charles met at Tillyard's and continued until after the Restoration. This Oxford Coffee Club was the start of the Royal Society.

<sup>15</sup> Parkinson, John. *Theatrum Botanicum*. London, 1640. (p. 1622.)

<sup>16</sup> D'Israeli, I. *Curiosities of Literature*. London, 1798. (vol. I: p. 345.)

Jacobs removed to Old Southampton Buildings, London, about the year 1671.

Meanwhile, the first coffee house in London had been opened by Pasqua Rosée in 1652; and, as the remainder of the story of coffee's rise and fall in England centers around the coffee houses of old London, we shall reserve it for a separate chapter.

Of course, the coffee-house idea, and the use of coffee in the home, quickly spread to other cities in Great Britain; but all the coffee houses were patterned after the Lon-

When the Bishop of Berytus (Beirut) was on his way to Cochin China in 1666, he reported that the Turks used coffee to correct the indisposition caused in the stomach by the bad water. "This drink," he says, "imitates the effect of wine has not an agreeable taste but rather bitter, yet it is much used by these people for the good effects they find therein."

In 1686, John Ray (1628-1704), one of the most celebrated English naturalists, published his *Universal History of Plants*,

**Although they be destitute of Taverns, yet haue they their Coffa-houses, which something resemble them. There sit they chatting most of the day, and sippe of a drinke called Coffa (of the berry that it is made of) in little China dishes, as hot as they can suffer it: blacke as soote, and tasting not much vn-like it (why not that blacke broth which was in vse amongst the Lacedemonians?) which helpeth, as they say, digestion, and procureth alacrity: many of the Coffamen keeping beautifull boyes, who serue as stales to procure them customers.**

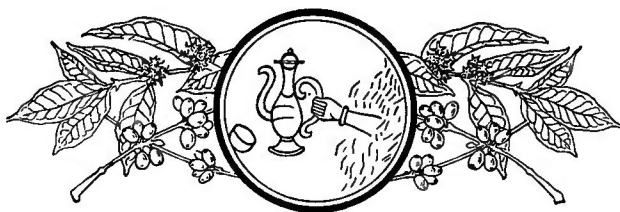
EARLY ENGLISH REFERENCE TO COFFEE BY SIR GEORGE SANDYS  
From the seventh edition of *Sandy's Travels*, London, 1673

don model. Mol's coffee house at Exeter, Devonshire, which is pictured on page 37, was one of the first coffee houses established in England, and may be regarded as typical of those that sprang up in the provinces. Previously it had been a noted club house; and the old hall, beautifully paneled with oak, still displays the arms of noted members. Here Sir Walter Raleigh and congenial friends regaled themselves with smoking tobacco. This was one of the first places where tobacco was smoked in England. It is now an art gallery.

notable among other things for being the first work of its kind to extol the virtues of coffee in a scientific treatise.

R. Bradley, professor of botany at Cambridge, published (1714) *A Short Historical Account of Coffee*, all trace of which appears to be lost.

Dr. James Douglas published in London (1727) his *Arbor Yemensis fructum Cofe ferens; or, a description and History of the Coffee Tree*, in which he laid under heavy contribution the Arabian and French writers that had preceded him.



## CHAPTER VI

### INTRODUCTION INTO HOLLAND AND SCANDINAVIA

HOW THE ENTERPRISING DUTCH TRADERS CAPTURED THE FIRST WORLD'S MARKET FOR COFFEE—ACTIVITIES OF THE NETHERLANDS EAST INDIA COMPANY—THE FIRST COFFEE HOUSE AT THE HAGUE—THE FIRST PUBLIC AUCTION AT AMSTERDAM, IN 1711, WHEN JAVA COFFEE BROUGHT FORTY-SEVEN CENTS A POUND, GREEN—HOW COFFEE WAS OUTLAWED FOR MANY YEARS FOLLOWING ITS INTRODUCTION INTO THE SCANDINAVIAN COUNTRIES

THE Dutch had early knowledge of coffee because of their dealings with the Orient and with the Venetians, and of their nearness to Germany, where Rauwolf first wrote about it in 1582. They were familiar with Alpini's writings on the subject in 1592. Paludanus, in his coffee note on *Linschooten's Travels*, furnished further enlightenment in 1598.

The Dutch were always great merchants and shrewd traders. Being of a practical turn of mind, they conceived an ambition to grow coffee in their colonial possessions, so as to make their home markets headquarters for a world's trade in the product. In considering modern coffee-trading, the Netherlands East India Company may be said to be the pioneer, as it established in Java one of the first experimental gardens for coffee cultivation.

The Netherlands East India Company was formed in 1602. As early as 1614, Dutch traders visited Aden to examine into the possibilities of coffee and coffee-trading. In 1616 Pieter van dan Broeck brought the first coffee from Mocha to Holland. In 1640 a Dutch merchant, named Wurffbain, offered for sale in Amsterdam the first commercial shipment of coffee from Mocha. As indicating the enterprise of the Dutch, note that this was four years before the beverage was introduced into France, and only three years after Conopios had privately instituted the breakfast coffee cup at Oxford.

About 1650, Varnar, the Dutch minister

resident at the Ottoman Porte, published a treatise on coffee.

When the Dutch at last drove the Portuguese out of Ceylon in 1658, they began the cultivation of coffee there, although the plant had been introduced into the island by the Arabs prior to the Portuguese invasion in 1505. However, it was not until 1690 that the more systematic cultivation of the coffee plant by the Dutch was undertaken in Ceylon.

Regular imports of coffee from Mocha to Amsterdam began in 1663. Later, supplies began to arrive from the Malabar coast.

Pasqua Rosée, who introduced the coffee house into London in 1652, is said to have made coffee popular as a beverage in Holland by selling it there publicly in 1664. The first coffee house was opened in the Korten Voorhout, the Hague, under the protection of the writer Van Essen; others soon followed in Amsterdam and Haarlem.

At the instigation of Nicolaas Witsen, burgomaster of Amsterdam and governor of the East India Company, Adrian van Ommen, commander of Malabar, sent the first Arabian coffee seedlings to Java in 1696, as recorded in Chapter I. These were destroyed by flood, but were followed in 1699 by a second shipment, from which developed the coffee trade of the Netherlands East Indies, that made Java coffee a household word in every civilized country.

A trial shipment of the coffee grown near Batavia was received at Amsterdam in 1706, also a plant for the botanical gar-

dens. This plant subsequently became the progenitor of most of the coffees of the West Indies and America.

The first Java coffee for the trade was received at Amsterdam, 1711. The shipment consisted of 894 pounds from the Jakatra plantations and from the interior of the island. At the first public auction, this coffee brought twenty-three and two-thirds *stuivers* (about forty-seven cents) per Amsterdam pound.

The Netherlands East India Company contracted with the regents of Netherlands India for the compulsory delivery of coffee; and the natives were enjoined to cultivate coffee, the production thus becoming a forced industry worked by government. A "general system of cultivation" was introduced into Java in 1832 by the government, which decreed the employment of forced labor for different products. Coffee-growing was the only forced industry that existed before this system of cultivation, and it was the only government cultivation that survived the abolition of the system in 1905-08. The last direct government interest in coffee was closed out in 1918. From 1870 to 1874, the government plantations yielded an average of 844,854 piculs<sup>1</sup> a year; from 1875 to 1878, the average was 866,674 piculs. Between 1879 and 1883, it rose to 987,682 piculs. From 1884 to 1888, the average annual yield was only 629,942 piculs.

Holland readily adopted the coffee house; and among the earliest coffee pictures preserved to us is one depicting a scene in a Dutch coffee house of the seventeenth century, the work of Adriaen Van Ostade (1610-1675).

History records no intolerance of coffee in Holland. The Dutch attitude was ever that of the constructionist. Dutch inventors and artisans gave us many new designs in coffee mortars, coffee roasters, and coffee serving-pots.

Coffee appears to have been little known in Scandinavian countries before 1700, but

<sup>1</sup> A weight of from 133 to 140 pounds.



A COFFEE RAID IN SWEDEN

From an aquatint, by M. R. Heland after a painting by P. Nordqvist in 1799

by 1746 its use there had reached such proportions as to arouse the hostility of certain elements of the intellegentsia, and a royal edict was issued in Sweden against "the misuse and excesses of tea and coffee drinking." The following year the government put into effect an excise tax on tea and coffee drinkers. Those subject to the tax, who failed to declare themselves, were threatened with arrest and a fine of 100 silver thalers, together with "confiscation of cups and dishes."

In 1756, coffee drinking was completely prohibited, whereupon coffee bootlegging became a considerable, if illegitimate, branch of trade. Attempts to tighten the coffee prohibition were made by a new law in 1766, but coffee continued to be smuggled into the country. The government then concluded that, since it could not stop the trade, it might at least derive some benefit therefrom, so in 1769 coffee was subjected to an import tax. In 1794, the regency again attempted coffee prohibition, but abandoned it in 1796 on account of strong popular disapproval and resistance. Notwithstanding this experience, the authorities returned to the attack in 1799 to 1802, with no better success.

A final attempt to suppress the use of coffee was made in the period of 1817-1822, after which the authorities bowed to the inevitable.



## CHAPTER VII

### THE INTRODUCTION OF COFFEE INTO GERMANY

THE CONTRIBUTIONS MADE BY GERMAN TRAVELERS AND WRITERS TO THE LITERATURE OF THE EARLY HISTORY OF COFFEE—THE FIRST COFFEE HOUSE IN HAMBURG OPENED BY AN ENGLISH MERCHANT—FAMOUS COFFEE HOUSES OF OLD BERLIN—THE FIRST COFFEE PERIODICAL, AND THE FIRST KAFFEE-KLATSCH—FREDERICK THE GREAT'S COFFEE-ROASTING MONOPOLY—COFFEE PERSECUTIONS—"COFFEE-SMELLERS"—THE FIRST COFFEE KING

AS we have already seen, Leonhard Rauwolf, in 1573, made his memorable trip to Aleppo and, in 1582, won for Germany the honor of being the first European country to make printed mention of the coffee drink.

Adam Olearius, or Oelschlager, a German orientalist (1599-1671), traveled in Persia as secretary to a German embassy in 1633-36. Upon his return he published an account of his journeys. In it, under date of 1637, he says of the Persians:

They drink with their tobacco a certain black water, which they call *cahwa*, made of a fruit brought out of Egypt, and which is in colour like ordinary wheat, and in taste like Turkish wheat, and is of the bigness of a little bean. . . . The Persians think it allays the natural heat.

In 1637, Joh. Albrecht von Mandelsloh, in his *Oriental Trip*, mentions "the black water of the Persians called *Kahwe*," saying "it must be drunk hot."

Coffee drinking was introduced into Germany about 1670. The drink appeared at the court of the great Elector of Brandenburg in 1675. Northern Germany got its first taste of the beverage from London, an English merchant opening the first coffee house in Hamburg in 1679-80. Regensburg followed in 1689; Leipsic, in 1694; Nuremberg, in 1696; Stuttgart, in 1712; Augsburg, in 1713; and Berlin, in 1721. In that year (1721) King Frederick William I granted a foreigner the privilege of conducting a coffee house in Berlin free of all rental charges. It was known as the

English coffee house, as was also the first coffee house in Hamburg. And for many years, English merchants supplied the coffees consumed in northern Germany; while Italy supplied southern Germany.

Other well known coffee houses of old Berlin were, the Royal, in Behrenstrasse; that of the Widow Doebbert, in the Stechbahn; the City of Rome, in Unter-den-Linden; Arnoldi, in Kronenstrasse; Miercke, in Taubenstrasse, and Schmidt, in Poststrasse.

Later, Philipp Falek opened a Jewish coffee house in Spandauerstrasse. In the time of Frederick the Great (1712-1786) there were at least a dozen coffee houses in the metropolitan district of Berlin. In the suburbs were many tents where coffee was served.

The first coffee periodical, *The New and Curious Coffee House*, was issued in Leipsic in 1707 by Theophilo Georgi. The full title was *The New and Curious Coffee House, formerly in Italy but now opened in Germany. First water debauchery. "City of the Well." Brunnenstadt by Lorentz Schoepffwasser* [draw-water] 1707. The second issue gave the name of Georgi as the real publisher. It was intended to be in the nature of an organ for the first real German kaffee-klatsch. It was a chronicle of the comings and goings of the savants who frequented the "Tusculum" of a well-to-do gentleman in the outskirts of the city. At the beginning the master of the house declared:

I know that the gentlemen here speak French, Italian and other languages. I know also that in many coffee and tea meetings it is considered requisite that French be spoken. May I ask, however, that he who calls upon me should use no other language but German. We are all Germans, we are in Germany; shall we not conduct ourselves like true Germans?

In 1721 Leonhard Ferdinand Meisner published at Nuremberg the first comprehensive German treatise on coffee, tea, and chocolate.

During the second half of the eighteenth century coffee entered the homes, and began to supplant flour-soup and warm beer at breakfast tables.

Meanwhile coffee met with some opposition in Prussia and Hanover. Frederick the Great became annoyed when he saw how much money was paid to foreign coffee merchants for supplies of the green bean, and tried to restrict its use by making coffee a drink of the "quality." Soon all the German courts had their own coffee roasters, coffee pots, and coffee cups.

Many beautiful specimens of the finest porcelain cups and saucers made in Meissen, and used at court fêtes of this period, survive in the collections at the Potsdam and Berlin museums. The wealthy classes followed suit; but when the poor grumbled because they could not afford the luxury, and demanded their coffee, they were told in effect: "You had better leave it alone. Anyhow, it's bad for you because it causes sterility." Many doctors lent themselves to a campaign against coffee, one of their favorite arguments being that women using the beverage must forego child-bearing. Bach's *Coffee Cantata*<sup>1</sup> (1732) was a notable protest in music against such libels.

On September 13, 1777, Frederick issued a coffee and beer manifesto, a curious document, which recited:

It is disgusting to notice the increase in the quantity of coffee used by my subjects, and the amount of money that goes out of the country in consequence. Everybody is using coffee. If possible, this must be prevented. My people must drink beer. His Majesty was brought up on beer, and so were his ancestors, and his officers. Many battles have been fought and won by soldiers nourished on beer; and the King does not believe that coffee-drinking soldiers can be depended upon to endure hardship or to beat his enemies in case of the occurrence of another war.

For a time beer was restored to its honored place; and coffee continued to be a

<sup>1</sup> See chapter XXXVIII.

luxury afforded only by the rich. Soon a revulsion of feeling set in; and it was found that even Prussian military rule could not enforce coffee prohibition. Whereupon, in 1781, finding that all his efforts to reserve the beverage for the exclusive court circles, the nobility, and the officers of his army, were vain, the king created a royal monopoly in coffee, and forbade its roasting except in royal roasting establishments. At the same time, he made exceptions in the cases of the nobility, the clergy, and government officials; but rejected all applications for coffee-roasting licenses from the common people. His object, plainly, was to confine the use of the drink to the elect. To these representatives of the cream of Prussian society, the king issued special licenses permitting them to do their own roasting. Of course, they purchased their supplies from the government; and as the price was enormously increased, the sales yielded Frederick a handsome income. Incidentally, the possession of a coffee-roasting license became a kind of badge of membership in the upper class. The poorer classes were forced to get their coffee by stealth; and, failing this, they fell back

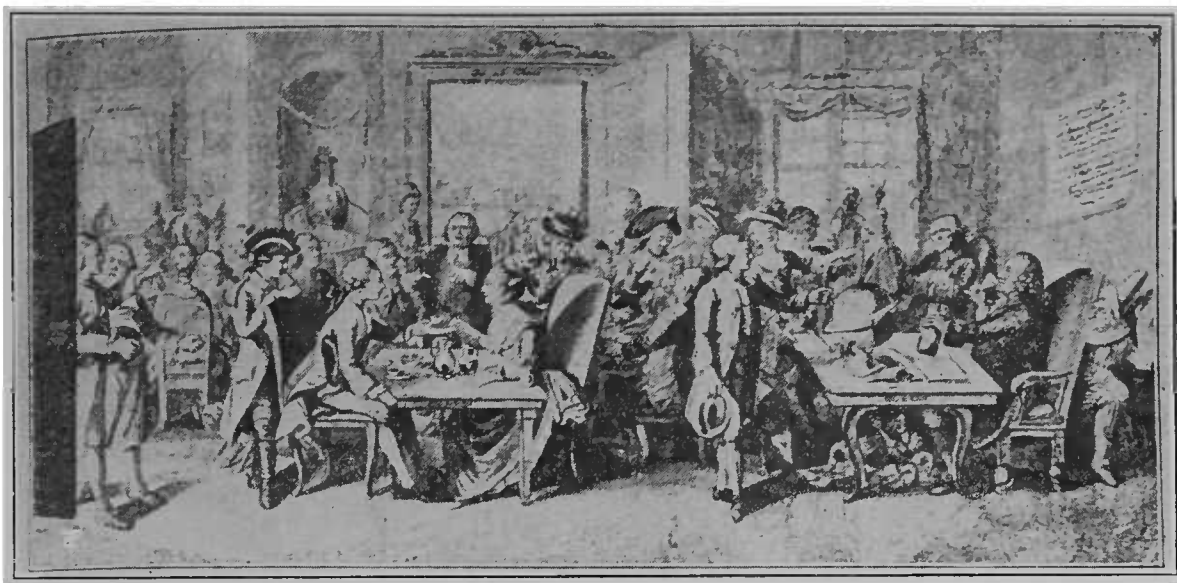


RICHTER'S COFFEE HOUSE IN LEIPSIK—SEVENTEENTH CENTURY

upon numerous barley, wheat, corn, chicory, and dried-fig substitutes, that soon appeared in great numbers.

This singular coffee ordinance was known as the "*Déclaration du Roi concernant la vente du café brûlé*," and was published January 21, 1781.

After placing the coffee revenue in the hands of a Frenchman, Count de Lannay,



COFFEE HOUSE IN GERMANY—MIDDLE OF THE SEVENTEENTH CENTURY

so many deputies were required to make collections that the administration of the law became a veritable persecution. Discharged wounded soldiers were mostly employed, and their principle duty was to spy upon the people day and night, following the smell of roasting coffee whenever detected, in order to seek out those who might be found without roasting permits. The spies were given one-fourth of the fine collected. These deputies made themselves so great a nuisance, and became so cordially disliked, that they were called "coffee-smellers" by the indignant people.

Taking a leaf out of Frederick's book, the Elector of Cologne, Maximilian Frederick, bishop of Münster, Duchy of Westphalia, on February 17, 1784, issued a manifesto which said:

To our great displeasure we have learned that in our Duchy of Westphalia the misuse of the coffee beverage has become so extended that to counteract the evil we command that four weeks after the publication of this decree no one shall sell coffee roasted or not roasted under a fine of one hundred dollars, or two years in prison, for each offense.

Every coffee-roasting and coffee-serving place shall be closed, and dealers and hotel-keepers are to get rid of their coffee supplies in four weeks. It is only permitted to obtain from the outside coffee for one's own consumption in lots of fifty pounds. House fathers and mothers shall not allow their work people, especially their washing and ironing women, to prepare coffee, or to allow it in any manner under a penalty of one hundred dollars.

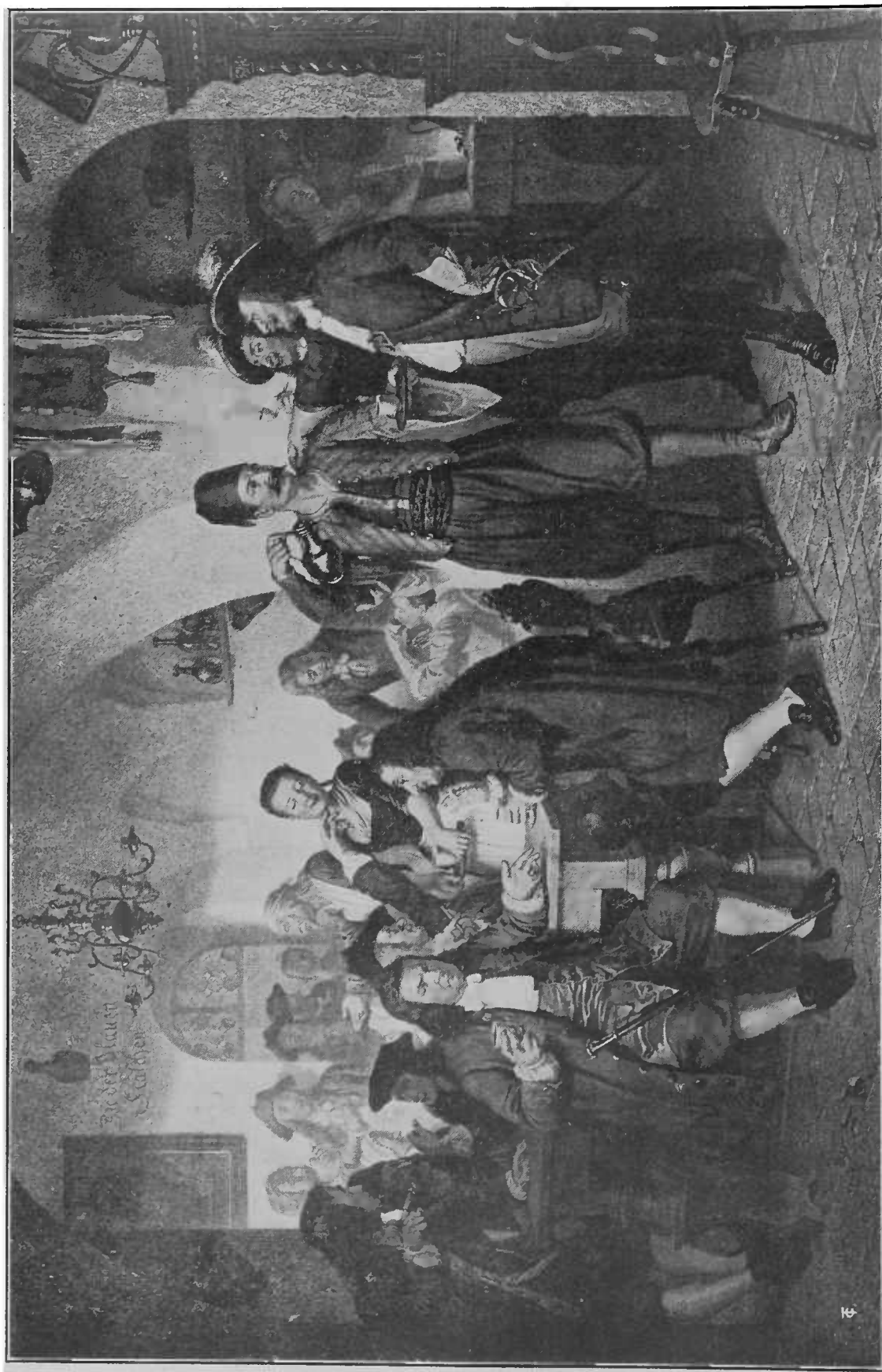
All officials and government employees, to

avoid a penalty of one hundred gold florins, are called upon closely to follow and to keep a watchful eye over this decree. To the one who reports such persons as act contrary to this decree shall be granted one-half of the said money fine with absolute silence as to his name.

This decree was solemnly read in the pulpits, and was published besides in the usual places and ways. There immediately followed a course of "telling-ons", and of "coffee-smellings", that led to many bitter enmities and caused much unhappiness in the Duchy of Westphalia. Apparently the purpose of the archduke was to prevent persons of small means from enjoying the drink, while those who could afford to purchase fifty pounds at a time were to be permitted the indulgence. As was to be expected, the scheme was a complete failure.

While the king of Prussia exploited his subjects by using the state coffee monopoly as a means of extortion the duke of Württemberg had a scheme of his own. He sold to Joseph Suess-Oppenheimer, an unscrupulous financier, the exclusive privilege of keeping coffee houses in Württemberg. Suess-Oppenheimer in turn sold the individual coffee-house licenses to the highest bidders, and accumulated a considerable fortune. He was the first "coffee king."

But coffee outlived all these unjust slanders and cruel taxations of too paternal governments, and gradually took its rightful place as one of the favorite beverages of the German people.



**KOLSCHITZKY, THE GREAT BROTHER-HEART, IN HIS BLUE BOTTLE CAFE, VIENNA, 1683**  
From a lithograph after the painting by Franz Schams, entitled "Das Erste (Kulczycki'sche) Kaffee Haus"

## CHAPTER VIII

### TELLING HOW COFFEE CAME TO VIENNA

THE ROMANTIC ADVENTURE OF FRANZ GEORGE KOLSCHITZKY, HERO OF THE TURKISH SIEGE, WHO WON FOR HIMSELF THE HONOR OF BEING THE FIRST TO TEACH THE VIENNESE THE ART OF MAKING COFFEE, AND WHO FELL HEIR TO THE GREEN BEANS LEFT BEHIND BY THE TURKS—AFFECTIONATE REGARD IN WHICH "BROTHER-HEART" KOLSCHITZKY IS HELD AS THE PATRON SAINT OF THE VIENNA KAFFEESIEDER—LIFE IN THE EARLY VIENNA CAFÉS

A ROMANTIC tale has been woven around the introduction of coffee into Austria. When Vienna was besieged by the Turks in 1683, so runs the legend, Franz George Kolschitzky, a native of Poland, formerly an interpreter in the Turkish army, saved the city and won for himself undying fame, with coffee as his principal reward.

It is not known whether, in the first siege of Vienna by the Turks in 1529, the invaders boiled coffee over their camp fires that surrounded the Austrian capital; although they might have done so, as Selim I, after conquering Egypt in 1517, had brought with him to Constantinople large stores of coffee as part of his booty. But it is certain that when they returned to the attack, 154 years later, they carried with them a plentiful supply of the green beans.

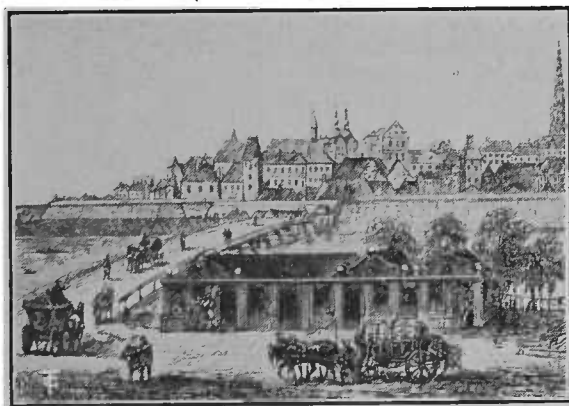
Mohammed IV mobilized an army of 300,000 men and sent it forth under his vizier, Kara Mustapha, Kuprili's successor, to destroy Christendom and to conquer Europe. Reaching Vienna July 7, 1683, the army quickly invested the city and cut it

off from the world. Emperor Leopold had escaped the net and was several miles away. Nearby was the prince of Lorraine, with an army of 33,000 Austrians, awaiting the succor promised by John Sobieski, king of Poland, and an opportunity to relieve the

besieged capital. Count Rudiger von Starhemberg, in command of the forces in Vienna, called for a volunteer to carry a message through the Turkish lines to hurry along the rescue. He found him in the person of Franz George Kolschitzky, who had lived for many years among the Turks and was well acquainted with

their language and customs.

On August 13, 1683, Kolschitzky donned a Turkish uniform, passed through the enemy's lines and reached the Emperor's army across the Danube. Several times he made the perilous journey between the camp of the prince of Lorraine and the garrison of the governor of Vienna. One account says that he had to swim the four intervening arms of the Danube each time he performed the feat. His messages did much to keep up the morale of the city's



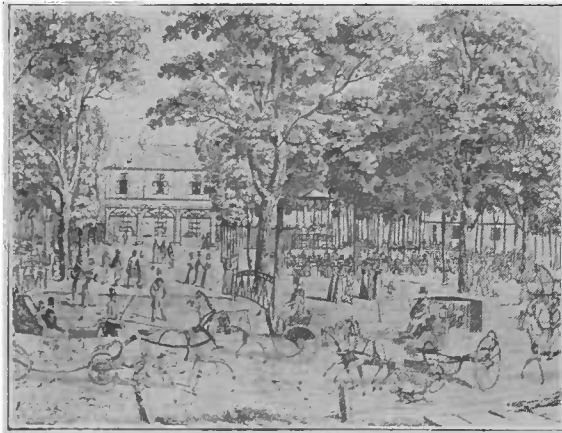
THE FIRST COFFEE HOUSE IN THE LEOPOLDSTADT, FROM BERMANN'S *Alt und Neu Wien*





KOLSCHITZKY, IN TURKISH UNIFORM, PASSING THROUGH THE ENEMY'S LINES

defenders. At length King John and his army of rescuing Poles arrived and were consolidated with the Austrians on the summit of Mount Kahlenberg. It was one of the most dramatic moments in history. The fate of Christian Europe hung in the balance. Everything seemed to point to the triumph of the crescent over the cross. Once again Kolschitzky crossed the Danube, and brought back word concerning the sig-



THE FIRST COFFEE HOUSE IN THE HAUPTALLEE OF THE NOBELPRATER

nals that the prince of Lorraine and King John would give from Mount Kahlenberg to indicate the beginning of the attack. Count Starhemberg was to make a sortie at the same time.

The battle took place September 12, and thanks to the magnificent generalship of King John, the Turks were routed. The Poles here rendered a never-to-be-forgotten service to all Christendom. The Turkish invaders fled, leaving 25,000 tents, 10,000 oxen, 5,000 camels, 100,000 bushels of grain, a great quantity of gold, and many sacks filled with coffee—at that time unknown in Vienna. The booty was distributed; but no one wanted the coffee. They did not know what to do with it; that is, no one except Kolschitzky. He said, "If nobody wants those sacks, I will take them," and every one was heartily glad to be rid of the strange beans. But Kolschitzky knew what he was about, and he soon taught the Viennese the art of preparing coffee. Later, he established the first public booth where Turkish coffee was served in Vienna.

This, then, is the story of how coffee was



THE FASHIONABLE COFFEE HOUSE OF FORMER DAYS AT THE SCHLAG BRIDGE

introduced into Vienna, where was developed that typical Vienna café which has become a model for a large part of the world. Kolschitzky is honored in Vienna as the patron saint of coffee houses. His followers, united in the guild of coffee makers, *kaffee-sieder*, and erected a statue in his honor. It still stands as part of the façade of a house where the Kolschitzky-gasse merges into the Favoritengasse, as shown in the picture on page 47.

Vienna is sometimes called the "mother of cafés". Café Sacher is world-renowned.

Tart à la Sacher is to be found in every cook-book. The Viennese have their *jause* every afternoon. When one drinks coffee at a Vienna café one generally has a *kipfel* with it. This is a crescent-shaped roll—baked for the first time in the eventful year 1683, when the Turks besieged the city. A baker made these crescent rolls in a spirit of defiance of the Turk. Holding sword in one hand and *kipfel* in the other, the Viennese would show themselves on top of their redoubts and challenge the cohorts of Mohammed IV.

Mohammed IV was deposed after losing the battle, and Kara Mustapha was executed for leaving the stores—particularly the sacks of coffee beans—at the gates of Vienna; but Vienna coffee and Vienna *kipfel* are still alive, and their appeal is not lessened by the years.

The hero Kolschitzky was presented with a house by the grateful municipality; and there, at the sign of the Blue Bottle, according to one account, he continued as a coffee-house keeper for many years.<sup>1</sup> This, in brief, is the story that—although not authenticated in all its particulars—is seriously related in many books, and is firmly believed throughout Vienna.

It seems a pity to discredit the hero of so romantic an adventure; but the archives of Vienna throw a light upon Kolschitzky's later conduct which tends to show that, after all, this Viennese idol's feet were of common clay.

It is said that Kolschitzky, after receiving the sacks of green coffee left behind by the Turks, at once began to peddle the

<sup>1</sup> Vulcaren, John Peter A. *Relation of the Siege of Vienna*. 1684.



THE "YOUNG MEN'S" COFFEE HOUSE, NEAR THE DANUBE RIVER, 18TH CENTURY



STATUE OF KOLSCHITZKY ERECTED BY THE COFFEE MAKERS GUILD OF VIENNA

beverage from house to house, serving it in little cups from a wooden platter. Later he rented a shop in Bischof-hof. Then he began to petition the municipal council, that, in addition to the sum of 100 ducats already promised him as recognition of his valor, he should receive a house with good will attached; that is, a shop in some growing business section. "His petitions to the municipal council," writes M. Bermann, "are amazing examples of measureless self-conceit and the boldest greed. He seemed determined to get the utmost out of his own self-sacrifice. He insisted upon the most highly deserved reward, such as the Romans bestowed upon their Curtius, the Lacedæmonians upon their Pompilius, the Athenians upon Seneca, with whom he modestly compared himself."<sup>2</sup>

At last, he was given his choice of three houses in the Leopoldstadt, any one of

<sup>2</sup> Bermann, M. *Alt und Neu Wien*. Vienna, 1880. (p. 964.)

them worth from 400 to 450 gulden, in place of the money reward, which had been fixed by a compromise agreement at 300 gulden. But Kolschitzky was not satisfied with this; and urged that if he was to accept a house in full payment it should be one valued at not less than 1,000 gulden. Then ensued much correspondence and considerable haggling. To put an end to the acrimonious dispute, the municipal council in 1685 directed that there should be deeded over to Kolschitzky and his wife, Maria Ursula, without further argument, the house known at that time as 30 (now 8) Haidgasse.

It is further recorded that Kolschitzky sold the house within a year and, after many moves, died of tuberculosis, February 20, 1694, aged fifty-four years. He was courier to the emperor at the time of his death, and was buried in the Stefansfriedhof.

Kolschitzky's heirs moved the coffee house to Donaustrand, near the wooden Schlagbrücke, later known as Ferdinand's *Brücke* (bridge). The celebrated coffee house of Franz Mosee (d. 1860) stood on this same spot.

In the city records for the year 1700 a house in the Stock-im-Eisen-Platz is designated by the words "*allwo das erste kaffee-gewölbe,*" or "here was the first coffee house." Unfortunately, the name of the proprietor is not given.

Many stories are told of Kolschitzky's

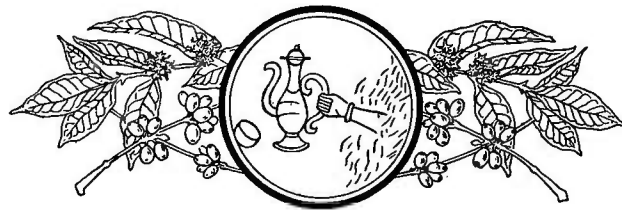
popularity as a coffee-house keeper. He is said to have addressed everyone as *Bruderherz*, brother-heart, and gradually he himself acquired the name *Bruderherz*. A portrait of Kolschitzky, painted about the time of his greatest vogue, is carefully preserved by the Coffee Makers' Guild of Vienna.

Even during the lifetime of the first *kaffee-sieder*, a number of coffee houses were opened and acquired some little fame. Early in the eighteenth century a tourist gives us a glimpse of the progress made by coffee drinking and by the coffee-house idea in Vienna. We read:

The city of Vienna is filled with coffee houses, where the novelists or those who busy themselves with the newspapers delight to meet, to read the gazettes and discuss their contents. Some of these houses have a better reputation than others because such *zeitungs-doctors* ["newspaper doctors", an ironical title] gather there to pass most unhesitating judgment on the weightiest events, and to surpass all others in their opinions concerning political matters and considerations.

All this wins them such respect that many congregate there because of them, and to enrich their minds with inventions and foolishness which they immediately run through the city to bring to the ears of the said personalities. It is impossible to believe what freedom is permitted, in furnishing this gossip. They speak without reverence not only of the doings of generals and ministers of state, but also mix themselves in the life of the Kaiser himself.

Vienna liked the coffee house so well that by 1839 there were eighty of them in the city proper and fifty more in the suburbs.



## CHAPTER IX

### THE COFFEE HOUSES OF OLD LONDON

FIRST COFFEE HOUSE IN LONDON—FIRST COFFEE HANDBILL AND FIRST NEWSPAPER ADVERTISEMENT OF COFFEE—FANTASTIC COFFEE CLAIMS—EARLY COFFEE-HOUSE MANNERS AND CUSTOMS—COFFEE-HOUSE KEEPERS' TOKENS—OPPOSITION TO THE COFFEE HOUSE—EVOLUTION OF THE CLUB—DECLINE AND FALL OF THE COFFEE HOUSE—PEN PICTURES OF COFFEE-HOUSE LIFE—FAMOUS COFFEE HOUSES OF THE SEVENTEENTH AND EIGHTEENTH CENTURIES—SOME OLD WORLD PLEASURE GARDENS—LOCATION OF NOTABLE COFFEE HOUSES

THE two most picturesque chapters in the history of coffee have to do with the period of the old London and Paris coffee houses of the seventeenth and eighteenth centuries. Much of the poetry and romance of coffee centers around this time.

"The history of coffee houses," says D'Israeli, "ere the invention of clubs, was that of the manners, the morals and the politics of a people." And so the history of the London coffee houses of the seventeenth and eighteenth centuries is indeed the history of the manners and customs of the English people of that period.

#### *The First London Coffee House*

"The first coffee house in London," says John Aubrey (1626-97), the English antiquary and folklorist, "was in St. Michael's Alley, in Cornhill, opposite to the church, which was sett up by one . . . Bowman (coachman to Mr. Hodges, a Turkey merchant, who putt him upon it) in or about the year 1652. 'Twas about four years before any other was sett up, and that was by Mr. Farr. Jonathan Paynter, over-against to St. Michael's Church, was the first apprentice to the trade, viz., to Bowman."<sup>1</sup>

Another account, for which we are indebted to William Oldys (1696-1761), the bibliographer, relates that Mr. Edwards, a

London merchant, acquired the coffee habit in Turkey, and brought home with him from Ragusa, in Dalmatia, Pasqua Rosée, an Armenian or Greek youth, who prepared the beverage for him. "But the novelty thereof," says Oldys, "drawing too much company to him, he allowed the said servant with another [servant] of his son-in-law to set up the first coffee house in London at St. Michael's Alley, in Cornhill."


From this it would appear that Pasqua Rosée had as partner in this enterprise, the Bowman, who, according to Aubrey, was coachman to Mr. Hodges, the son-in-law of Mr. Edwards, and a fellow merchant traveler.

Oldys tells us that Rosée and Bowman soon separated. John Timbs (1801-1875), another English antiquary, says they quarreled, Rosée keeping the house, and his partner Bowman obtaining leave to pitch a tent and to sell the drink in St. Michael's churchyard.

Still another version of this historic incident is to be found in *Houghton's Collection*, 1698. It reads:

It appears that a Mr. Daniel Edwards, an English merchant of Smyrna, brought with him to this country a Greek of the name of Pasqua, in 1652, who made his coffee; this Mr. Edwards married one Alderman Hodges's daughter, who lived in Walbrook, and set up Pasqua for a coffee man in a shed in the churchyard in St. Michael, Cornhill, which is now a scrivener's brave-house, when, having great custom, the ale-sellers petitioned the Lord Mayor against

<sup>1</sup> Manuscript in the Bodleian Library.



## The Vertue of the *COFFEE* Drink.

First publiquely made and sold in England, by *Pasqua Rosée*.

**T**HE Grain or Berry called *Coffee*, groweth upon little Trees, only in the *Deserts of Arabia*.

It is brought from thence, and drunk generally throughout all the Grand Seigniors Dominions.

It is a simple innocent thing, composed into a Drink, by being dried in an Oven, and ground to Powder, and boiled up with Spring water, and about half a pint of it to be drunk, fasting an hour before, and not Eating an hour after, and to be taken as hot as possibly can be endured; the which will never fetch the skin off the mouth, or raise any Blisters, by reason of that Heat.

The Turks drink at meals and other times, is usually *Water*, and their Dyeet consist: much of *Fruit*; the *Crudities* whereof are very much corrected by this Drink.

The quality of this Drink is cold and Dry; and though it be a Dryer, yet it neither *heats*, nor *inflames* more then *hot Posset*.

It se closeth the Orifice of the Stomack, and fortifies the heat with it's very good to help digestion; and therefore of great use to be about 3 or 4 a Clock afternoon, as well as in the morning.

It quickens the *Spirits*, and makes the Heart *Lightsome*.

It is good against sore Eys, and the better if you hold your Head over it, and take in the Steem that way.

It suppresseth Fumes exceedingly, and therefore good against the *Head-ach*, and will very much stop any *Defluxion of Rheums*, that distil from the *Head* upon the *Stomack*, and so prevent and help *Consumptions*; and the *Cough of the Lungs*.

It is excellent to prevent and cure the *Dropsy*, *Gout*, and *Scurvy*.

It is known by experience to be better then any other Drying Drink for *People in years*, or *Children* that have any *running humors* upon them, as the *Kings Evil*. &c.

It is very good to prevent *Mis-carryings* in *Child-bearing Women*.

It is a most excellent Remedy against the *Spleen*, *Hypocondriack Winds*, or the like.

It will prevent *Drowsiness*, and make one fit for business, if one have occasion to *Watch*; and therefore you are not to Drink of it after *Supper*, unless you intend to be *watchful*, for it will hinder sleep for 3 or 4 hours.

It is observed that in *Turkey*, where this is generally drunk, that they are not troubled with the *Stone*, *Gout*, *Dropsie*, or *Scurvey*, and that their *Skins* are exceeding cleer and white.

It is neither *Laxative* nor *Restrington*.

Made and Sold in *St. Michaels Alley* in *Cornhill*, by *Pasqua Rosée*, at the Signe of his own Head.

### THE FIRST COFFEE ADVERTISEMENT, 1652

Handbill used by *Pasqua Rosée*, who opened the first coffee house in London  
From the original in the British Museum



him, as being no freeman. This made Alderman Hodges join his coachman, Bowman, who was free, as Pasqua's partner; but Pasqua, for some misdemeanor, was forced to run the country, and Bowman, by his trade and a contribution of 1,000 sixpences, turned the shed to a house. Bowman's apprentices were first, John Painter, then Humphry, from whose wife I had this account.

This account makes it appear that Edwards was Hodges' son-in-law. Whatever the relationship, most authorities agree that Pasqua Rosée was the first to sell coffee publicly, whether in a tent or shed, in London in or about the year 1652. His original shop-bill, or handbill, the first advertisement for coffee, is in the British Museum, and from it the accompanying photograph was made for this work. It sets forth in direct fashion: "The Vertue of the *COFFEE* Drink First publicly made and sold in England, by *Pasqua Rosée* in *St. Michaels Alley* in *Cornhill*. at the Signe of his own Head."<sup>2</sup>

H. R. Fox Bourne (about 1870) is alone in an altogether different version of this historic event. He says:

"In 1652 Sir Nicholas Crispe, a Levant merchant, opened in London the first coffee house known in England, the beverage being prepared by a Greek girl brought over for the work."<sup>3</sup>

There is nothing to substantiate this story; the preponderance of evidence is in support of the Edwards-Rosée version.

Such then was the advent of the coffee house in London, which introduced to English-speaking people the drink of democracy. Oddly enough, coffee and the Commonwealth came in together. The English coffee house, like its French contemporary, was the home of liberty.

Robinson, who accepts that version of the event wherein Edwards marries Hodges's daughter, says that after the partners Rosée and Bowman separated, and Bowman had set up his tent opposite Rosée, a zealous partisan addressed these verses "To Pasqua Rosée, at the Sign of his own Head and half his Body in St. Michael's Alley, next the first Coffee-Tent in London":

Were not the fountain of my Tears  
Each day exhausted by the steam  
Of your Coffee, no doubt appears  
But they would swell to such a stream  
As could admit of no restriction  
To see, poor Pasqua, thy Affliction.

<sup>2</sup> See also chapter XXXII.

<sup>3</sup> *The Romance of Trade*. London. (chap. II: p. 31.)

What! Pasqua, you at first did broach  
This Nectar for the publick Good,  
Must you call Kitt down from the Coach  
To drive a Trade he understood  
No more than you did then your creed,  
Or he doth now to write or read?

Pull Courage, Pasqua, fear no Harms  
From the besieging Foe;  
Make good your Ground, stand to your Arms,  
Hold out this summer, and then tho'  
He'll storm, he'll not prevail—your Face<sup>4</sup>  
Shall give the Coffee Pot the chace.

Eventually Pasqua Rosée disappeared, some say to open a coffee house on the Continent, in Holland or Germany. Bowman, having married Alderman Hodges's cook, and having also prevailed upon about a thousand of his customers to lend him sixpence apiece, converted his tent into a substantial house, and eventually took an apprentice to the trade.

Concerning London's second coffee-house keeper, James Farr, proprietor of the Rainbow, who had as his most distinguished visitor Sir Henry Blount, Edward Hatton says:

I find it recorded that one James Farr, a barber, who kept the coffee-house which is now the Rainbow, by the Inner Temple Gate (one of the first in England), was in the year 1657, prosecuted by the inquest of St. Dunstan's in the West, for making and selling a sort of liquor called coffe, as a great nuisance and prejudice to the neighborhood, etc., and who would then have thought London would ever have had near three thousand such nuisances, and that coffee would have been, as now, so much drank by the best of quality and physicians?<sup>5</sup>

Hatton evidently attributed Farr's nuisance to the coffee itself, whereas the presentment clearly shows it was in Farr's chimney and not in the coffee.<sup>6</sup>

Mention has already been made that Sir Henry Blount was spoken of as "the father of English coffee houses" and his claim to this distinction would seem to be a valid one, for his strong personality "stamped itself upon the system." His favorite motto, "*Loquendum est cum vulgo, sentendum cum sapientibus*" [the crowd may talk about it; the wise decide it], says Robinson, "expresses well their colloquial purpose, and was natural enough on the lips of one whose experience had been world wide." Aubrey says of Sir Henry Blount, "He is now neer or altogether eighty yeares,

<sup>4</sup> Pasqua Rosée's sign. Kitt's (or Bowman's) sign was a coffee pot.

<sup>5</sup> Hatton, Edward. *New View of London*. London, 1708. (vol. 1: p. 30.)

<sup>6</sup> The prosecution came under the heading, "Disorders and Annoys."



LONDON COFFEE-HOUSE SCENE IN THE EARLY EIGHTEENTH CENTURY

This little body-color drawing by an unknown English artist of the reign of Queen Anne was given by Mr. R. Y. Ames to the British Museum. It is a document of considerable interest for students of social history. It is a naïve and obviously faithful representation of the interior of a London coffee house, with its clients seated at tables, smoking and drinking coffee, which is poured out from a black pot by a boy waiter, while other coffee pots are kept hot before a blazing fire. It is possible that these pots were also used for tea at this period.

An elegant lady in a "Fontange" head-dress presides at a bar under a tester on the left, and is handing out a glass, the contents of which may be guessed from a framed notice on the wall: "Heare is Right Irish Usquebae." Of the newspapers which lie on the tables no word but "April" is legible. Pictures, perhaps for sale, adorn the wall; a connoisseur is examining one of them by the light of a candle. The prevailing colors are scarlet, pale blue, grey, and white, against a background of the various browns of wall, tables, and floor. The probable date, judging by the costume, is about 1705. The drawing resembles in several respects a small engraving of a coffee house which appeared in 1710, but is not the original of that engraving, and represents the fashions of a slightly earlier period. The date "A.S. (for 'Anno Salutis?') 1668" which appears to the left is obviously a later and spurious addition.

his intellectuals good still and body pretty strong."

Women played a not inconspicuous part in establishing businesses for the sale of the coffee drink in England, although the coffee houses were not for both sexes, as in other European countries. The London City *Quaeries* for 1660 makes mention of "a she-coffee merchant." Mary Stringar ran a coffee house in Little Trinity Lane in 1669; Anne Blunt was mistress of one of the Turk's-Head houses in Cannon Street in 1672. Mary Long was the widow of William Long, and her initials, together with those of her husband, appear on a token issued from the Rose tavern in Bridge Street, Covent Garden. Mary Long's token from the "Rose coffee house

by the playhouse" in Covent Garden is shown among the group of coffee-house keepers' tokens illustrated on page 58.

#### *The First Newspaper Advertisement*

The first newspaper advertisement of coffee appeared, May 26, 1657, in the *Publick Adviser* of London, one of the first weekly pamphlets. The name of this publication was erroneously given as the *Publick Advertiser* by an early writer on coffee, and the error has been copied by succeeding writers.

The first newspaper advertisement was contained in the issue of the *Publick Adviser* for the week of May 19 to May 26, and read:

In *Bartholomew Lane* on the back side of the Old Exchange, the drink called *Coffee*, which is a very wholsom and Physical drink, having many excellent vertues, closes the Orifice of the Stomack, fortifies the heat within, helpeth Digestion, quickneth the Spirits, maketh the heart lightsom, is good against Eye-sores, Coughs, or Colds, Rhumes, Consumptions, Head-ach, Dropisie, Gout, Scurvy, Kings Evil, and many others is to be sold both in the morning, and at three of the clock in the afternoon.

Chocolate was also advertised for sale in London the same year. The *Publick Adviser* of June 16, 1657, contained this announcement:

In Bishopgate Street, in Queen's Head Alley, at a Frenchman's house is an excellent West India drink called chocolate, to be sold, where you may have it ready at any time, and also unmade at reasonable rates.

Tea was first sold publicly at Garraway's, or Garway's, in 1657.

#### *Strange Coffee Mixtures*

The doctors were loath to let coffee escape from the mysteries of the pharmacopœia and become "a simple and refreshing beverage" that any one might obtain for a penny in the coffee houses, or, if preferred, might prepare at home. In this they were aided and abetted by many well-meaning but misguided persons, some of them men of considerable intelligence, who seemed possessed of the idea that the coffee drink was an unpleasant medicine that needed something to take away its curse, or else that it required a complex method of preparation. Witness "Judge" Walter Rumsey's *Electuary of Cophy*, which appeared in 1657 in connection with a curious work of his called *Organon Salutis: an instrument to cleanse the stomach*.

The instrument itself was a flexible whale-bone, two or three feet long, with a small linen or silk button at the end, and was designed to be introduced into the stomach to produce the effect of an emetic. The electuary of coffee was to be taken by the patient before and after using the instrument, which the Judge called his *Provang*. And this was the Judge's "new and superior way of preparing coffee" as found in his prescription for making electuary of "cophie":

Take equal quantity of Butter and Sallet-oyle, melt them well together, but not boyle them; Then stirre them well that they may incorporate together: Then melt therewith three times as much Honey, and stirre it well to-

gether: Then add thereunto powder of Turkish Cophie, to make it a thick Electuary.<sup>7</sup>

A little consideration will convince any one that the electuary was most likely to achieve the purpose for which it was recommended.

Another concoction invented by the Judge was known as "wash-brew", and included oatmeal, powder of "cophie", a pint of ale or any wine, ginger, honey, or sugar to please the taste; to these ingredients butter might be added and any cordial powder or pleasant spice. It was to be put into a flannel bag and "so keep it at pleasure like starch." This was a favorite medicine among the common people of Wales.

The book contained in a prefix an interesting historical document in the shape of a letter from James Howell (1595-1666) the writer and biographer, which read:

Touching coffee, I concur with them in opinion, who hold it to be that black-broth which was us'd of old in Lacedemon, whereof the Poets sing; Surely it must needs be salutiferous, because so many sagacious, and the wittiest sort of Nations use it so much; as they

<sup>7</sup> Rumsey (or Ramsey), W. *Organon Salutis*. London, 1657.

## The Publick Adviser,

WEEKLY

Communicating unto the whole

Nation the severall Occasions of all persons that are any way concerned in matter of Buying and Selling, or in any kind of Employment, or dealings whatsoever, according to the intent of the OFFICE OF PUBLICK ADVICE newly set up in severall places in and about London and Viscountshires.

For the better Accommodation and Ease of the People, and the Universal Benefit of the Commonwealth, in point of

**PUBLICK INTERCOURSE.**

From Tuesday May 19 to Tuesday May 26.

In *Bartholomew Lane* on the back side of the Old Exchange, the drink called *Coffee*, ( which is a very wholsom and Physical drink, having many excellent vertues, closes the Orifice of the Stomack, fortifies the heat within, helpeth Digestion, quickneth the Spirits, maketh the heart lightsom, is good against Eye-sores, Coughs, or Colds, Rhumes, Consumptions, Head-ach, Dropisie, Gout, Scurvy, Kings Evil, and many others is to be sold both in the morning, and at three of the clock in the afternoon.

FIRST NEWSPAPER ADVERTISEMENT OF COFFEE

It appeared in the London *Public Adviser* for the week of May 19 to May 26, 1657, ante-dating by about 16 months the first newspaper advertisement of tea, which appeared in the weekly *Mercurius Politicus*, London, September 23 to September 30, 1658.

who have conversed with Shashes and Turbants doe well know. But, besides the exsiccant quality it hath to dry up the crudities of the Stomach, as also to comfort the Brain, to fortife the sight with its steem, and prevent Dropsies, Gouts, the Scurvie, together with the Spleen and Hypochondriacall windes (all which it doth without any violance or distemper, at all). I say, besides all these qualities, 'tis found already, that this Coffee-drink hath caused a greater sobriety among the nations; for whereas formerly Apprentices and Clerks with others, used to take their mornings' draught in Ale, Beer or Wine, which by the dizziness they cause in the Brain, make many unfit for business, they use now to play the Good-fellows in this wakefull and civill drink: Therefore that worthy Gentleman, Mr. Mudiford,<sup>8</sup> who introduced the practice hereof first to London, deserves much respect of the whole nation.

The coffee drink at one time was mixed with sugar candy, and also with mustard. In the coffee houses, however, it was usually served black; "few people then mixed it with either sugar or milk.

#### *Fantastic Coffee Claims*

One can not fail to note in connection with the introduction of coffee into England that the beverage suffered most from the indiscretions of its friends. On the one hand, the quacks of the medical profession sought to claim it for their own; and, on the other, more or less ignorant laymen attributed to the drink such virtues as its real champions among the physicians never dreamed of. It was the favorite pastime of its friends to exaggerate coffee's merits; and of its enemies, to vilify its users. All this furnished good "copy" for and against the coffee house, which became the central figure in each new controversy.

From the early English author who damned it by calling it "more wholesome than toothsome," to Pasqua Rosée and his contemporaries, who urged its more fantastic claims, it was forced to make its way through a veritable morass of misunderstanding and intolerance. No harmless drink in history has suffered more at hands of friend and foe.

Did its friends hail it as a panacea, its enemies retorted that it was a slow poison. In France and in England there were those who contended that it produced melancholy, and those who argued it was a cure for the same. Dr. Thomas Willis (1621-1673), a distinguished Oxford phy-

<sup>8</sup> Also given as Sir James Muddiford, Murford, Mudford, Moundeford, and Modyford.

sician whom Antoine Portal (1742-1832) called "one of the greatest geniuses that ever lived," said he would sometimes send his patients to the coffee house rather than to the apothecary's shop. An old broadside, described later in this chapter, stressed the notion that if you "do but this Rare ARABIAN cordial use, and thou may'st all the Doctors Slops Refuse."

As a cure for drunkenness its "magic" power was acclaimed by its friends, and grudgingly admitted by its foes. This will appear presently in a description of the war of the broadsides and the pamphlets. Coffee was praised by one writer as a deodorizer. Another, Richard Bradley, in his treatise concerning its use with regard to the plague, said if its qualities had been fully known in 1665, "Dr. Hodges and other learned men of that time would have recommended it." As a matter of fact, in Gideon Harvey's *Advice against the Plague*, published in 1665, we find, "coffee is commended against the contagion."

This is how the drink's sobering virtue was celebrated by the author of the *Rebellious Antidote*:

Come, Frantick Fools, leave off your Drunken fits,  
Obsequious be and I'll recall your Wits,  
From perfect Madness to a modest Strain  
For farthings four I'll fetch you back again,  
Enable all your mene with tricks of State,  
Enter and sip and then attend your Fate;  
Come Drunk or Sober, for a gentle Fee,  
Come n'er so Mad, I'll your Physician be.

Dr. Willis, in his *Pharmaceutice Rationalis* (1674), was one of the first to attempt to do justice to both sides of the coffee question. At best, he thought it a somewhat risky beverage, and its votaries must, in some cases, be prepared to suffer languor and even paralysis; it may attack the heart and cause tremblings in the limbs. On the other hand it may, if judiciously used, prove a marvelous benefit; "being daily drunk it wonderfully clears and enlightens each part of the Soul and disperses all the clouds of every Function."

It was a long time before recognition was obtained for the truth about the "novelty drink"; especially that, if there were any beyond purely social virtues to be found in coffee, they were "political rather than medical."

Dr. James Duncan, of the Faculty of Montpellier, in his book *Wholesome Advice against the Abuse of Hot Liquors*, done

into English in 1706, found coffee no more deserving of the name of panacea than that of poison.

George Cheyne (1671-1743), the noted British physician, proclaimed his neutrality in the words, "I have neither great praise nor bitter blame for the thing."

#### *Coffee Prices and Coffee Licenses*

Coffee, with tea and chocolate, was first mentioned in the English Statute books in 1660, when a duty of four pence was laid upon every gallon made and sold, "to be paid by the maker." Coffee was classed by the House of Commons with "other outlandish drinks."

It is recorded in 1662 that "the right coffee powder" was being sold at the Turk's Head coffee house in Exchange Alley for "4s. to 6s. 8d. per pound; that pounded in a mortar, 2s.; East India berry, 1s. 6d.; and the right Turkie berry, well garbled [ground] at 3s. The ungarbled [in the bean] for less with directions how to use the same." Chocolate was also to be had at "2s. 6d. the pound; the perfumed from 4s. to 10s."

At one time coffee sold for five guineas a pound in England, and even forty crowns—about forty-eight dollars—a pound was paid for it.

In 1663, all English coffee houses were required to be licensed; the fee was twelve pence. Failure to obtain a license was punished by a fine of five pounds for every month's violation of the law. The coffee houses were under close surveillance by government officials. One of these was Muddiman, a good scholar and an "arch rogue," who had formerly "written for the Parliament" but who later became a paid spy. L'Éstrange, who had a patent on "the sole right of intelligence," wrote in his *Intelligencer* that he was alarmed at the ill effects of "the ordinary written papers of Parliament's news . . . making coffee houses and all the popular clubs judges of those councils and deliberations which they have nothing to do with at all."

The first royal warrant for coffee was given by Charles II to Alexander Man, a Scotsman who had followed General Monk to London, and set up in Whitehall. Here he advertised himself as "coffee man to Charles II."

Owing to increased taxes on tea, coffee, and newspapers, near the end of Queen

Anne's reign, 1714, coffee-house keepers generally raised their prices as follows: Coffee, two pence per dish; green tea, one and a half pence per dish. All drams, two pence per dram. At retail, coffee was then sold for five shillings per pound; while tea brought from twelve to twenty-eight shillings per pound.

#### *Coffee Club of The Rota*

"Coffee and Commonwealth," says a pamphleteer of 1665, "came in together for a Reformation, to make 's a free and sober nation." The writer argues that liberty of speech should be allowed, "where men of differing judgements croud"; and he adds, "that's a coffee house, for where should men discourse so free as there?" Robinson's comments are apt:

Now perhaps we do not always connect the ideas of sociableness and freedom of discussion with the days of Puritan rule; yet it must be admitted that something like geniality and openness characterized what Pepys calls the Coffee Club of the Rota. This "free and open Society of ingenious gentlemen" was founded in the year 1659 by certain members of the Republican party, whose peculiar opinions had been timidly expressed and not very cordially tolerated under the Great Oliver. By the weak Government that followed, these views were regarded with extreme dislike and with some amount of terror.

"They met," says Aubrey, who was himself of their number, "at the Turk's Head [Miles's coffee house] in New Palace Yard, Westminster, where they take water, at one Miles's, the next house to the staires, where was made purposely a large oval table, with a passage in the middle for Miles to deliver his coffee."

Robinson continues:

This curious refreshment bar and the interest with which the beverage itself was regarded, were quite secondary to the excitement caused by another novelty. When, after heated disputation, a member desired to test the opinion of the meeting, any particular point might, by agreement, be put to the vote and then everything depended upon "our wooden oracle," the first balloting-box ever seen in England. Formal methods of procedure and the intensely practical nature of the subjects discussed, combined to give a real importance to this Amateur Parliament.

The Rota, or Coffee Club, as Pepys called it, was essentially a debating society for the dissemination of republican opinions. It was preceded only, in the reign of Henry IV, by the club called La Court de Bone





A COFFEE HOUSE IN THE TIME OF CHARLES II  
From a woodcut of 1674

Compagnie; by Sir Walter Raleigh's Friday Street, or Bread Street, club; the club at the Mermaid tavern in Bread Street, of which Shakespeare, Beaumont, Fletcher, Raleigh, Selden, Donne, *et al.*, were members; and "rare" Ben Jonson's Devil tavern club, between Middle Temple Gate and Temple Bar.

The Rota derived its name from a plan, which it was designed to promote, for changing a certain number of members of parliament annually by rotation. It was founded by James Harrington, who had painted it in fairest colors in his *Oceana*, that ideal commonwealth.

Sir William Petty was one of its members. Around the table, "in a room every evening as full as it could be crammed," says Aubrey, sat Milton [?] and Marvell, Cyriac Skinner, Harrington, Nevill, and their friends, discussing abstract political questions.

The Rota became famous for its literary strictures. Among these was "The censure of the Rota upon Mr. Milton's book entitled *The ready and easie way to establish a free commonwealth*" (1660), although it is doubtful if Milton was ever a visitor to this "bustling coffee club." The Rota also censured "Mr. Driden's *Conquest of Granada*" (1673).

Among many of the early coffee-house keepers there was great anxiety that the

coffee house, open to high and low, should be conducted under such restraints as might secure the better class of customers from annoyance. The following set of regulations in somewhat halting rhyme was displayed on the walls of several of the coffee houses in the seventeenth century:

#### RULES AND ORDERS OF THE COFFEE HOUSE

Enter, Sirs, freely, but first, if you please,  
Peruse our civil orders, which are these.  
First, gentry, tradesmen, all are welcome hither,  
And may without affront sit down together:  
Pre-eminence of place none here should mind,  
But take the next fit seat that he can find:  
Nor need any, if finer persons come,  
Rise up to assigne to them his room;  
To limit men's expence, we think not fair,  
But let him forfeit twelve-pence that shall  
swear;  
He that shall any quarrel here begin,  
Shall give each man a dish t' atone the sin;  
And so shall he, whose compliments extend  
So far to drink in *coffee* to his friend;  
Let noise of loud disputes be quite forborne,  
No maudlin lovers here in corners mourn;  
But all be brisk and talk, but not too much,  
On sacred things, let none presume to touch  
Nor profane Scripture, nor sawcily wrong  
Affairs of state with an irreverent tongue:  
Let mirth be innocent, and each man see  
That all his jests without reflection be;  
To keep the house more quiet and from blame,  
We banish hence cards, dice, and every game;  
Nor can allow of wagers, that exceed  
.Five shillings, which oftentimes much trouble  
breed;  
Let all that's lost or forfeited be spent  
In such good liquor as the house doth vent.



And customers endeavour, to their powers,  
For to observe still, seasonable hours.  
Lastly, let each man what he calls for pay,  
And so you're welcome to come every day.

The early coffee houses were often up a flight of stairs, and consisted of a single large room with "tables set apart for divers topics." There is a reference to this in the prologue to a comedy of 1681 quoted by Malone:

In a coffee house just now among the rabble  
I bluntly asked, which is the treason table?

This was the arrangement at Man's and others favored by the wits, the *literati*, and "men of fashionable instincts." In the distinctly business coffee houses separate rooms were provided at a later time for mercantile transactions. The introduction of wooden partitions—wooden boxes, as at a tavern—was also of somewhat later date.

A print of 1674 shows five persons of different ranks in life, one of them smoking, sitting on chairs around a coffee-house table, on which are small basins, or dishes, without saucers, and tobacco pipes, while a coffee boy is serving coffee.

In the beginning, only coffee was dispensed in the English coffee houses. Soon chocolate, sherbet, and tea were added; but the places still maintained their status as social and temperance factors. Constantine Jennings, or George Constantine, of the "Grecian" advertised chocolate, sherbet and tea at retail in 1664-65; also free instruction in the art of preparing these liquors. "Drams and cordial waters were to be had only at coffee houses newly set up," says Elford the younger, writing about 1689. While some few places added ale and beer as early as 1669, intoxicating liquors were not items of importance for many years.

After the Great Fire of 1666, many new coffee houses were opened that were not limited to a single room up a flight of stairs. Because the coffee-house keepers over-emphasized the sobering qualities of the coffee drink, they drew many undesirable characters from the taverns and ale houses after the nine o'clock closing hour. These were hardly calculated to improve the reputation of the coffee houses; and, indeed, the decline of the coffee houses as a temperance institution would seem to trace back to this attitude of false pity for the victims of tavern vices, evils that many of the coffee houses later embraced, to their

own undoing. The early institution was unique, its distinctive features being unlike those of any public house in England or on the Continent. Later, in the eighteenth century, when these distinctive features became obscured, the name coffee house became a misnomer.

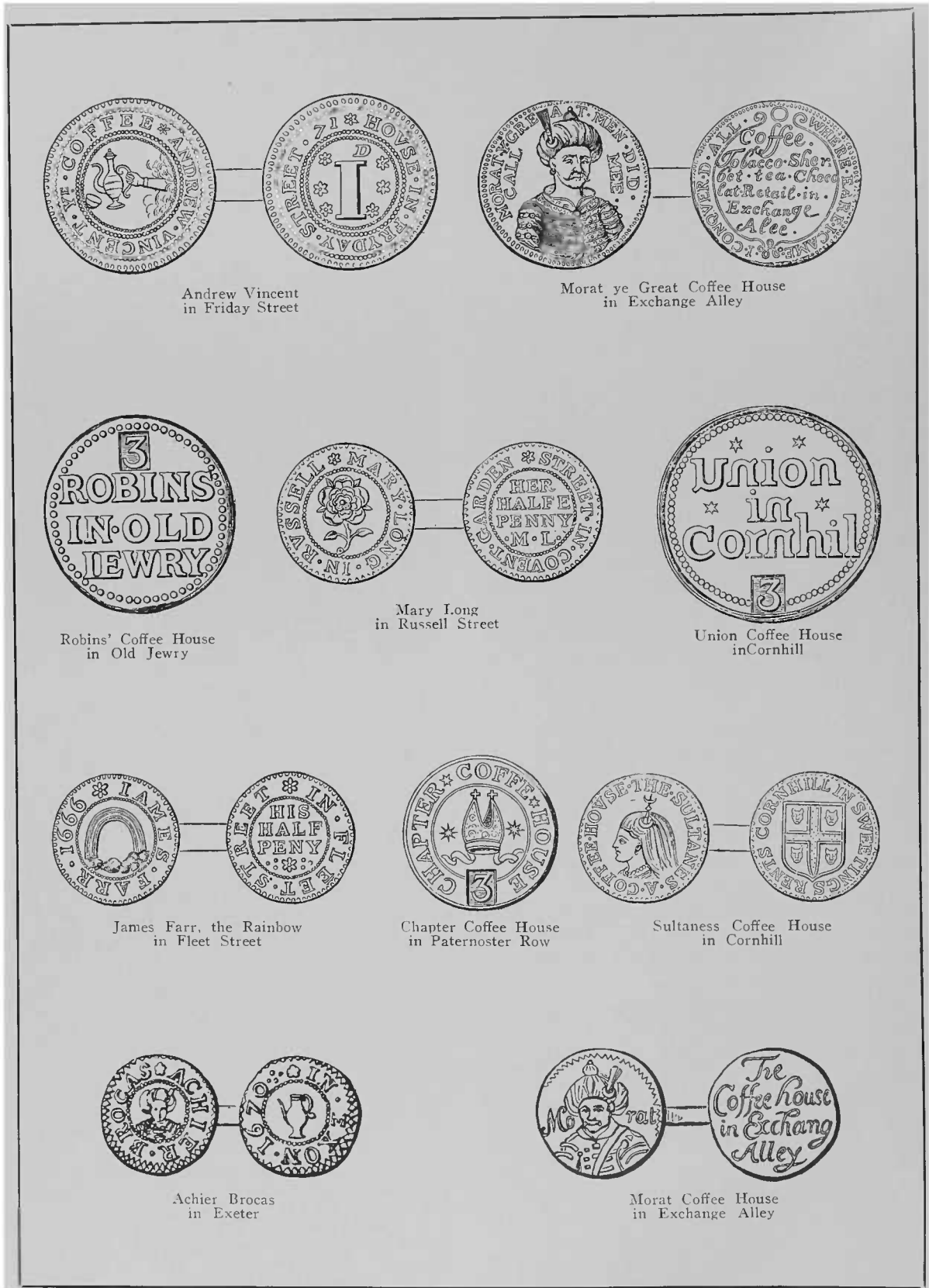
However, Robinson says, "the close intercourse between the habitués of the coffee house, before it lost anything of its gen-



A LONDON COFFEE HOUSE OF THE SEVENTEENTH CENTURY

From a wood cut of the period

erous social traditions and whilst the issue of the struggle for political liberty was as yet uncertain, was to lead to something more than a mere jumbling or huddling together of opposites. The diverse elements gradually united in the bonds of common sympathy, or were forcibly combined by persecution from without until



Andrew Vincent  
in Friday Street

Morat ye Great Coffee House  
in Exchange Alley

Robins' Coffee House  
in Old Jewry

Mary Long  
in Russell Street

Union Coffee House  
in Cornhill

James Farr, the Rainbow  
in Fleet Street

Chapter Coffee House  
in Paternoster Row

Sultaness Coffee House  
in Cornhill

Achier Brocas  
in Exeter

Morat Coffee House  
in Exchange Alley

**PLATE 1—COFFEE-HOUSE KEEPERS' TOKENS OF THE 17TH CENTURY**

Drawn for this work from the originals in the British Museum, and in the Beaufoy collection at the Guildhall Museum

there resulted a social, political and moral force of almost irresistible strength."

#### *Coffee-House Keepers' Tokens*

The Great Fire of 1666 destroyed some of the London coffee houses; but prominent among those that survived was the Rainbow, whose proprietor, James Farr,



COFFEE HOUSE, QUEEN ANNE'S TIME—1702-14  
Showing coffee pots, coffee dishes, and coffee boy

issued one of the earliest coffee-house tokens, doubtless in grateful memory of his escape. Farr's token shows an arched rainbow emerging from the clouds of the fire, indicating that all was well with him, and the Rainbow still radiant. On the reverse the medal was inscribed, "In Fleet Street—His Half Penny."

A large number of these trade coins were put out by coffee-house keepers and other tradesmen in the seventeenth century as evidence of an amount due, as stated thereon, by the issuer to the holder. Tokens originated because of the scarcity of small change. They were of brass, copper, pew-

ter, and even leather, gilded. They bore the name, address, and calling of the issuer, the nominal value of the piece, and some reference to his trade. They were readily redeemed, on presentation, at their face value. They were passable in the immediate neighborhood, seldom reaching farther than the next street. C. G. Williamson writes:

Tokens are essentially democratic; they would never have been issued but for the indifference of the Government to a public need; and in them we have a remarkable instance of a people forcing a legislature to comply with demands at once reasonable and imperative. Taken as a whole series, they are homely and quaint, wanting in beauty, but not without a curious domestic art of their own.

Robinson finds an exception to the general simplicity in the tokens issued by one of the Exchange Alley houses. The dies of these tokens are such as to have suggested the skilled workmanship of John Roettier. The most ornate has the head of a Turkish sultan at that time famed for his horrible deeds, ending in suicide; its inscription runs:

Morat ye Great Men did mee call;  
Where Eare I came I conquer'd all.

A number of the most interesting coffee-house keepers' tokens in the Beaufoy collection in the Guildhall Museum were photographed for this work, and drawings made from the photographs are shown herewith. It will be observed that many of the traders of 1660-75 adopted as their trade sign a hand pouring coffee from a pot, invariably of the Turkish-ewer pattern. Morat [Amurath] and Soliman were frequent coffee-house signs in the seventeenth century.

J. H. Burn, in his *Catalogue of Traders' Tokens*, recites that in 1672 "divers persons who presumed . . . to stamp, coin, exchange and distribute farthings, half-pence and pence of brass and copper" were "taken into custody, in order to a severe prosecution"; but upon submission, their offenses were forgiven, and it was not until the year 1675 that the private token ceased to pass current.

A royal proclamation at the close of 1674 enjoined the prosecution of any who should "utter base metals with private stamps," or "hinder the vending of those half pence and farthings which are provided for necessary exchange." After

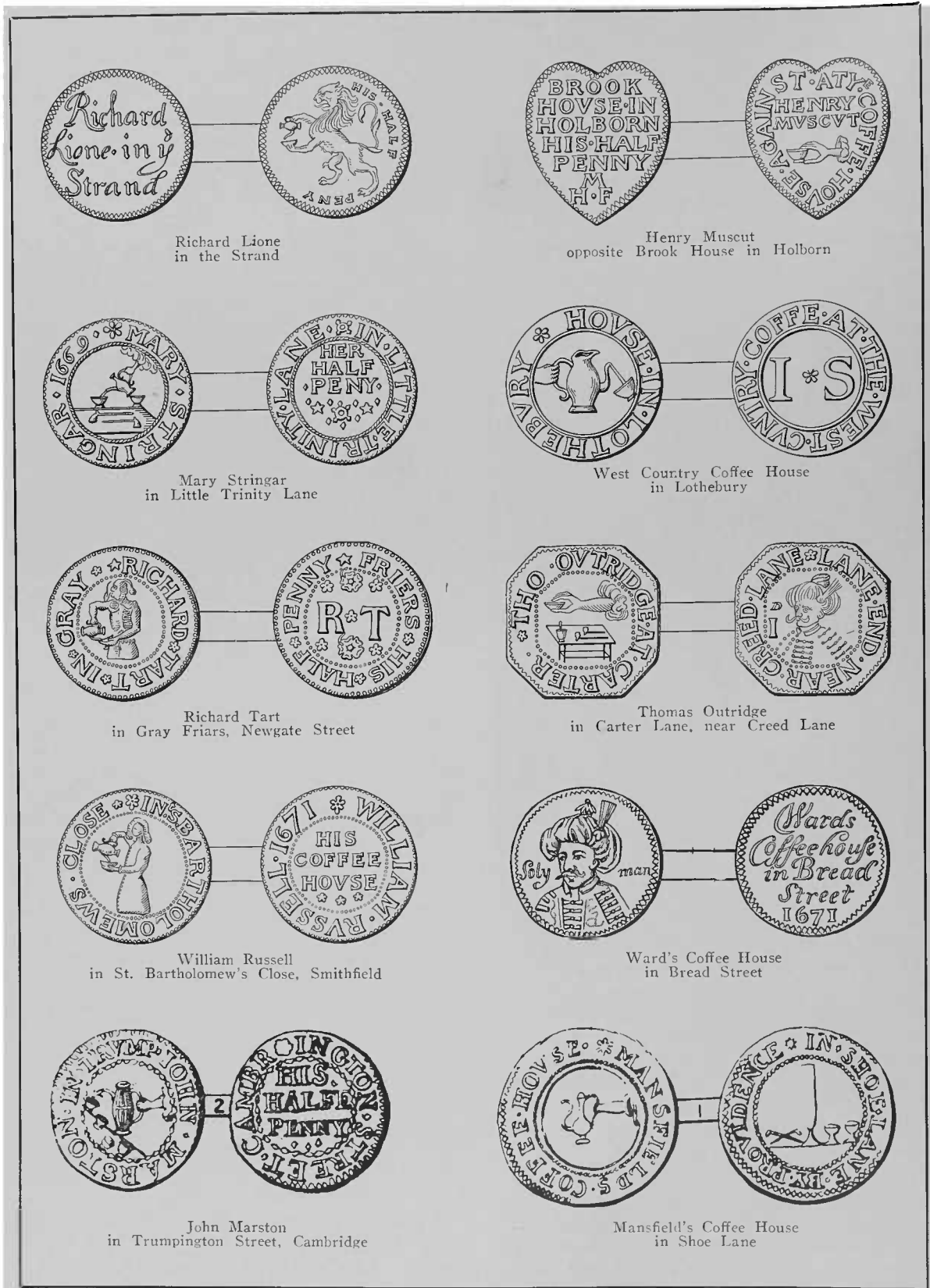


PLATE 2—COFFEE-HOUSE KEEPERS' TOKENS OF THE 17TH CENTURY

Drawn for this work from the originals in the British Museum, and in the Beaufoy collection at the Guildhall Museum

this, tokens were issued stamped "necessary change."

Opposition to the Coffee House

It is easy to see why the coffee houses at once found favor among men of intelligence in all classes. Until they came, the average Englishman had only the tavern as a place of common resort. But here was a public house offering a non-intoxicating beverage, and its appeal was instant and universal. As a meeting place for the exchange of ideas it soon attained wide popularity. But not without opposition. The publicans and ale-house keep-

where the Puritan element was still in the ascendant. A numerous company is present, and each little group being occupied with its own subject, the general effect is that of another Babel. While one is engaged in quoting the classics, another confides to his neighbors how much he admires Euclid:

A third's for a lecture, a fourth a conjecture, A fifth for a penny in the pound.

Theology is introduced. Mask balls and plays are condemned. Others again discuss the news, and are deep in the store of "Mercuries" here to be found. One cries up philosophy. Pedantry is rife, and for the most part unchecked, when each 'prentice-boy "doth call for his coffee in Latin" and all are so prompt with their learned quotations that "'t would make a poor Vicar to tremble."

The first noteworthy effort attacking the coffee drink was a satirical broadside that appeared in 1663. It was entitled A Cup of Coffee: or, Coffee in its Colours. It said:

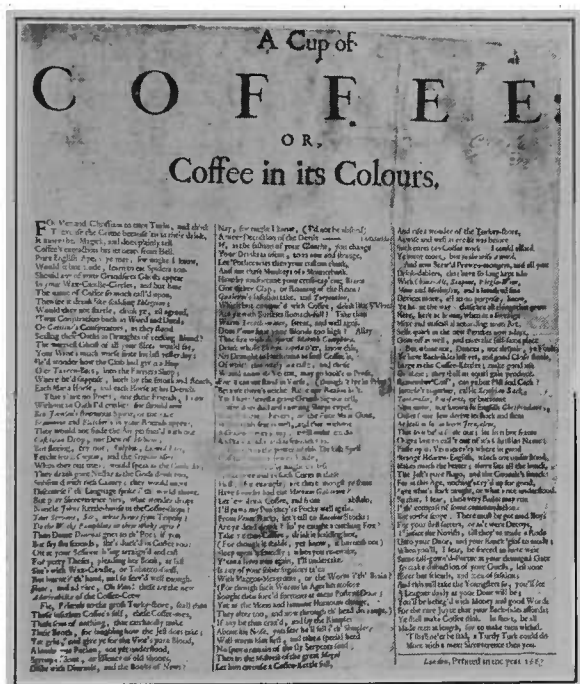
For men and Christians to turn Turks, and think T' excuse the Crime because 'tis in their drink, Is more than Magick Pure English Apes! Ye may, for ought I know, Would it but mode, learn to eat Spiders too.

The writer wonders that any man should prefer coffee to canary, and refers to the days of Beaumont, Fletcher, and Ben Jonson. He says:

They drank pure nectar as the gods drink too, Sublim'd with rich Canary shall then These less than coffee's self, these coffee-men, These sons of nothing, that can hardly make Their Broth, for laughing how the jest doth take; Yet grin, and give ye, for the Vine's pure Blood A loathsome potion, not yet understood, Syrrup of soot, or Essence of old Shoes, Dasht with Diurnals and the Books of news?

The author of A Cup of Coffee, it will be seen, does not shrink from using epithets. The Coffee Man's Granado Discharged upon the Maiden's Complaint Against Coffee, a dialogue in verse, also appeared in 1663.

The Character of a Coffee House, by an Eye and Ear Witness appeared in 1665. It was a ten page pamphlet, and proved to be excellent propaganda for coffee. It is so well done, and contains so much local color, that it is reproduced here, the text being copied from the original in the British Museum. The title page reads:



A BROADSIDE OF 1663

ers, seeing business slipping away from them, made strenuous propaganda against this new social center; and not a few attacks were launched against the coffee drink. Between the Restoration and the year 1675, of eight tracts written upon the subject of the London coffee houses, four have the words "character of a coffee house" as part of their titles. The authors appear eager to impart a knowledge of the town's latest novelty, with which many readers were unacquainted.

One of these early pamphlets (1662) was entitled The Coffee Scuffle, and professed to give a dialogue between "a learned knight and a pitifull pedagogue." It contained an amusing account of a house



THE  
CHARACTER  
OF A  
COFFEE-HOUSE  
wherein  
Is contained a Description of the Persons  
usually frequenting it, with their Dis-  
course and Humors,  
As Also  
The Admirable Vertues of  
COFFEE  
By an Eye and Ear Witness  
*When Coffee once was vended here,  
The Ale'ron shortly did appear,  
For our Reformers were such Widgeons.  
New Liquors brought in new Religions.*  
Printed in the Year, 1665.

The text and the arrangement of the body of the pamphlet are as follows:

THE  
CHARACTER  
OF A  
COFFEE-HOUSE

THE DERIVATION OF  
A COFFEE-HOUSE

A *Coffee-house*, the learned hold  
It is a place where *Coffee's* sold;  
This derivation cannot fail us,  
For where *Ale's* vended, that's an *Ale-house*,  
This being granted to be true,  
'Tis meet that next the *Signs* we shew  
Both *where* and *how* to find this house  
Where men such *cordial broth* carowse.  
And if *Culpepper* woon some glory  
In turning the *Dispensatory*  
From *Latin* into *English*; then  
Why should not all good *English men*  
Give him much thanks who shews a *cure*  
For all diseases men endure?

SIGNS: HOW TO  
FIND IT OUT

As you along the streets do trudge,  
To take the pains you must not grudge,  
To view the Posts or Broomsticks where  
The Signs of *Liquors* hanged are.  
And if you see the great *Morat*  
With Shash on's head instead of hat.  
Or any *Sultan* in his dress,  
Or picture of a *Sultanness*,  
Or *John's* admir'd curled pate,  
Or th' great *Mogul* in's Chair of State,  
Or *Constantine* the *Grecian*,  
Who fourteen years was th' onely man  
That made *Coffee* for th' great *Bashaw*,  
Although the man he never saw;  
Or if you see a *Coffee-cup*  
Fil'd from a Turkish pot, hung up  
Within the clouds, and round round it *Pipes*,  
*Wax candles*, *Stoppers*, these are types  
And certain signs (with many more  
Would be too long to write them 'ore,)   
Which plainly do Spectators tell  
That in that house they *Coffee* sell.  
Some wiser than the rest (no doubt,)  
Say they can by the smell find't out;  
In at a door (say they,) but thrust  
Your Nose, and if you scent *burnt Crust*,  
Be sure there's *Coffee* sold that's good,  
For so by most 'tis understood.  
Now being enter'd, there's no needing

Of complements or gentile breeding,  
For you may seat you any where,  
There's no respect of persons there;  
Then comes the *Coffee-man* to greet you,  
With welcome Sir, let me entreat you,  
To tell me what you'l please to have,  
For I'm your humble, humble slave;  
But if you ask, what good does *Coffee*?  
He'l answer, Sir, don't think I scoff yee,  
If I affirm there's no disease  
Men have that drink it but find ease.

THE VERTUES  
OF COFFEE

Look, there's a man who takes the steem  
In at his Nose, has an extreme  
*Worm* in his pate, and giddiness  
Ask him and he will say no less.  
There sitteth one whose Droptick belly  
Was hard as flint, now's soft as jelly.  
There stands another holds his head  
'Ore th' *Coffee-pot*, was almost dead  
Even now with Rhume; ask him hee'l say  
That all his Rhum's now past away.  
See, there's a man sits now demure  
And sober, was within this hour  
Quite drunk, and comes here frequently,  
For 'tis his daily Malady,  
More, it has such reviving power  
'Twill keep a man awake an houre,  
Nay, make his eyes wide open stare  
Both Sermon time and all the prayer.  
Sir, should I tell you all the rest  
O' th' cures 't has done, two hours at least  
In numb'ring them I needs must spend,  
Scarce able then to make an end.  
Besides these vertues that's therein,  
For any kind of *Medicine*,  
The *Commonwealth-Kingdom* I'd say,  
Has mighty reason for to pray  
That still *Arabia* may produce  
Enough of *Berry* for it's use:  
For't has such strange magnetick force,  
That it draws after't great concourse  
Of all degrees of persons, even  
From high to low, from morn till even;  
Especially the *sober Party*,  
And News-mongers do drink't most hearty.  
Here you'r not thrust into a *Box*  
As *Taverns* do to catch the *Fox*,  
But as from th' top of *Pauls* high steeple  
Th' whole *City's* view'd, even so all *people*  
May here be seen; no secrets are  
At th' *Court* for *Peace*, or th' *Camp* for *War*,  
But straight they'r here disclos'd and known;  
Men in this Age so wise are grown.  
Now (Sir) what profit may accrew  
By this, to all good men, judge you.  
With that he's loudly call'd upon  
For *Coffee*, and then whip he's gone.

THE COMPANY

Here at a Table sits (perplext)  
A griping *Usurer*, and next  
To him a gallant *Furioso*,  
Then nigh to him a *Virtuoso*;  
A *Player* then (full fine) sits down  
And close to him a *Country Clown*.  
O' th' other side sits some *Pragmatick*,  
And next to him some sly *Phanatick*.

THE SEVERAL  
LIQUORS

The gallant he for *Tca* doth call,

The *Usurer* for nought at all.  
 The *Pragmatick* he doth intreat  
 That they will fill him some *Beau-cheat*,  
 The *Virtuoso* he cries hand me  
 Some *Coffee* mixt with *Sugar-candy*.  
*Phanaticus* (at last) says come,  
 Bring me some *Aromaticum*.  
 The *Player* bawls for *Chocolate*,  
 All which the *Bumpkin* wond'ring at,  
 Cries, ho, my *Masters*, what d' ye speak,  
 D' ye call for drink in Heathen Greek?  
 Give me some good old *Ale* or *Beer*,  
 Or else I will not drink, I swear.

## THEIR DISCOURSE

Then having charg'd their *Pipes* around,  
 They silence break; First the profound  
 And sage *Phanatique*, Sirs what news?  
 Troth says the *Us'rer* I ne'er use  
 To tip my tongue with such discourse,  
 'Twere news to know how to disburse  
 A summ of mony (makes me sad)  
 To get ought by't, times are so bad.  
 The other answers, truly Sir  
 You speak but truth, for I'le aver  
 They ne'er were worse; did you not hear  
 What *prodigies* did late appear  
 At *Norwich*, *Ispwich*, *Grantham*, *Gotam*?  
 And though prophane ones do not not'em,  
 Yet we—Here th' *Virtuoso* stops  
 The current of his speech, with hopes  
 Quoth he, you will not tak'd amiss,  
 I say all's lies that's news like this,  
 For I have *Factors* all about  
 The Realm, so that no *Stars* peep out  
 That are unusual, much less these  
 Strange and unheard-of *prodigies*  
 You would relate, but they are tost  
 To me in letters by first Post.  
 At which the *Furioso* swears  
 Such chat as this offends his ears  
 It rather doth become this Age  
 To talk of bloodshed, fury, rage,  
 And t' drink stout healths in brim-fill'd *Nogans*.  
 To th' downfall of the *Hogan Mogans*.  
 With that the *Player* doffs his Bonnet,  
 And tunes his voice as if a Sonnet  
 Were to be sung; then gently says,  
 O what delight there is in *Plays*!  
 Sure if we were but all in *Peace*,  
 This noise of *Wars* and *News* would cease;  
 All sorts of people then would club  
 Their pence to see a Play that's good.  
 You'l wonder all this while (perhaps)  
 The *Curioso* holds his chaps.  
 But he doth in his thoughts devise,  
 How to the rest he may seem wise;  
 Yet able longer not to hold,  
 His tedious tale too must be told,  
 And thus begins, Sirs unto me  
 It reason seems that liberty  
 Of speech and words should be allow'd  
 Where men of differing judgements croud,  
 And that's a *Coffee-house*, for where  
 Should men discourse so free as there?  
*Coffee* and *Commonwealth* begin  
 Both with one letter, both came in  
 Together for a *Reformation*,  
 To make's a free and sober *Nation*.  
 But now—With what *Phanaticus*  
 Gives him a nod, and speaks him thus,  
 Hold brother, I know your intent,  
 That's no dispute convenient

For this same place, truths seldome find  
 Acceptance here, they'r more confin'd  
 To *Taverns* and to *Ale-house* liquor,  
 Where men do vent their minds more quicker  
 If that may for a truth but pass  
 What's said, *In vino veritas*.  
 With that up starts the *Country Clown*,  
 And stares about with threatening frown  
 As if he would even eat them all up.  
 Then bids the boy run quick and call up,  
 A *Constable*, for he has reason  
 To fear their Latin may be *treason*  
 But straight they all call what's to pay,  
 Lay't down, and march each several way.

## THE COMPANY

At th' other table sits a Knight,  
 And here a *grave old man* ore right  
 Against his *worship*, then perhaps  
 That *by* and *by* a *Drawer* claps  
 His bum close by them, there down squats  
 A *dealer in old shoes and hats*;  
 And here withouten any panick  
 Fear, dread or care a bold *Mechanick*.

## THEIR DISCOURSE

The *Knight* (because he's so) he prates  
 Of matters far beyond their pates.  
 The *grave old man* he makes a bustle,  
 And his wise sentence in must justle.  
 Up starts th' *Apprentice boy* and he  
 Says boldly so and so't must be.  
 The *dealer in old shoes* to utter  
 His saying too makes no small sputter.  
 Then comes the pert *mechanick blade*,  
 And contradicts what all have said.

\* \* \*

There by the fier-side doth sit,  
 One freezing in an *Ague* fit.  
 Another poking in't with th' tongs,  
 Still ready to cough up his lungs  
 Here sitteth one that's melancolick,  
 And there one singing in a frolick.  
 Each one hath such a prety gesture,  
 At Smithfield fair would yield a tester.  
 Boy reach a pipe cries he that shakes,  
 The songster no Tobacco takes,  
 Says he who coughs, nor do I smoak,  
 Then *Monsieur Mopus* turns his cloak  
 Off from his face, and with a grave  
 Majestick beck his pipe doth crave.  
 They load their guns and fall a smoaking  
 Whilst he who coughs sits by a choaking,  
 Till he no longer can abide.  
 And so removes from th' fier side.  
 Now all this while none calls to drink,  
 Which makes the *Coffee boy* to think  
 Much they his pots should so enclose,  
 He cannot pass but tread on toes.  
 With that as he the *Nectar* fills  
 From pot to pot, some on't he spills  
 Upon the *Songster*. Oh cries he.  
 Pox, what dost do? thou'st burnt my knee;  
 No says the boy, (to make a bald  
 And blind excuse.) *Sir 'twil not scald*.  
 With that the man lends him a cuff  
 O' th' ear, and whips away in snuff.  
 The other two, their pipes being out,  
 Says *Monsieur Mopus* I much doubt  
 My friend I wait for will not come,  
 But if he do, say I'm gone home.  
 Then says the *Aguish man* I must come  
 According to my wonted custome,

To give ye' a visit, although now  
I dare not drink, and so *adieu*.  
The boy replies, O Sir, however  
You'r very welcome, we do never  
Our *Candles, Pipes or Fier* grutch  
To daily customers and such,  
They'r *Company* (without expence,)  
For that's sufficient recompence.  
Here at a table all alone,  
Sits (studying) a *spruce youngster*, (one  
Who doth conceit himself fully witty,  
And's counted *one o' the wits o' th' city*),  
Till by him (with a stately grace,)  
A Spanish *Don* himself doth place.  
Then (cap in hand) a brisk *Monsieur*  
He takes his seat, and crowds as near  
As possibly that he can come.  
Then next a *Dutchman* takes his room.  
The Wits glib tongue begins to chatter,  
Though't utters more of noise than matter,  
Yet 'cause they seem to mind his words,  
His lungs more battle still affords  
At last says he to *Don*, I trow  
You understand me? *Sennor no*  
Says th' other. Here the Wit doth pause  
A little while, then opes his jaws,  
And says to *Monsieur*, you enjoy  
Our tonguc I hope? *Non par ma foy*,  
Replies the *Frenchman*: nor you, Sir?  
Says he to th' *Dutchman*, *Neen mynheer*,  
With that he's gone, and cries, why sho'd  
He stay where *wit's* not understood?  
There in a place of his own chusing  
(Alone) some *lover* sits a musing,  
With arms across, and's eyes up lift,  
As if he were of sence bereft,  
Till sometimes to himself he's speaking,  
Then sighs as if his heart were breaking.  
Here in a corner sits a *Phrantick*,  
And there stands by a frisking Antick,  
Of all sorts some and all conditions  
Even *Vintners, Surgeons and Physicians*.  
The *blind, the deaf, and aged cripple*  
Do here resort and Coffee tipple.

Now here (perhaps) you may expect  
My *Muse* some trophies should erect  
In high flown verse, for to set forth  
The *noble praises* of its worth.

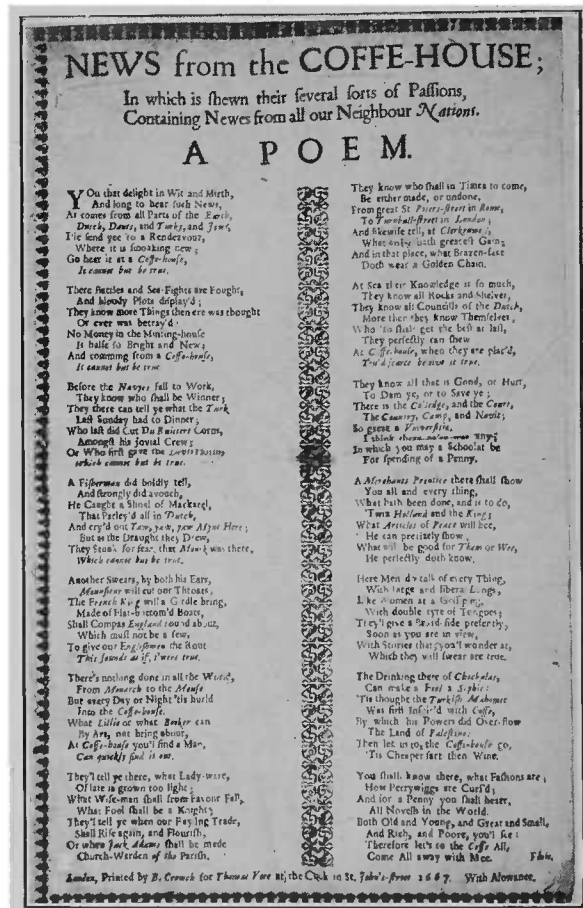
Truth is, *old Poets* beat their brains  
To find out high and lofty strains  
To praise the (now too frequent) use  
Of the bewitching *grapes strong juice*,  
Some have strain'd hard for to exalt  
The *liquor* of our *English Mault*  
Nay *Don* has almost crackt his *nodle*  
Enough t' applaud his *Caaco Caudle*.  
The *Germans Mum, Teag's Usquebagh*,  
(Made him so well defend *Tredagh*),  
*Metheglin*, which the *Brittains* tope,  
Hot *Brandy* wine, the *Hogans* hope.  
Stout *Meade* which makes the *Russ* to laugh,  
Spic'd *Punch* (in bowls,) the *Indians* quaff.  
All these have had their pens to raise  
Them *Monuments* of lasting praise,  
Onely poor *Coffee* seems to me  
No subject fit for *Poetry*  
At least 'tis one that none of mine is,  
So I do wave 't, and here write—

FINIS.

*News from the Coffee House; in which  
is shewn their several sorts of Passions ap-*

peared in 1667. It was reprinted in 1672  
as *The Coffee House or Newsmongers'  
Hall*.

Several stanzas from these broadsides  
have been much quoted. They serve to  
throw additional light upon the manners  
of the time, and upon the kind of conver-  
sation met with in any well frequented  
coffee house of the seventeenth century,  
particularly under the Stuarts. They are  
finely descriptive of the company char-



A BROADSIDE OF 1667

acteristics of the early coffee houses. The  
fifth stanza of the edition of 1667, inimical  
to the French, was omitted when the broad-  
side was amended and reprinted in 1672,  
the year that England joined with France  
and again declared war on the Dutch. The  
following verses with explanatory notes are  
from Timbs:

NEWS FROM THE COFFEE HOUSE

You that delight in Wit and Mirth,  
And long to hear such News,  
As comes from all Parts of the *Earth*,  
*Dutch, Danes, and Turks, and Jews*,

I'll send yee to a Rendezvous,  
Where it is smoaking new;  
Go hear it at a *Coffee-house*,  
*It cannot but be true.*

There Battles and Sea-Fights are Fought,  
And bloody Plots display'd;  
They know more Things then ere was thought  
Or ever was betray'd;  
No Money in the Minting-house  
Is halfe so Bright and New;  
And comming from a *Coffee-house*  
*It cannot but be true.*

Before the *Navyes* fall to Work,  
They know who shall be Winner;  
They there can tell ye what the *Turk*  
Last *Sunday* had to Dinner;  
Who last did Cut *Du Ruitters*'<sup>9</sup> Corns,  
Amongst his jovial Crew;  
Or Who first gave the *Devil* Horns,  
*Which cannot but be true.*

A *Fisherman* did boldly tell,  
And strongly did avouch,  
He Caught a Shoal of Mackarel,  
That Parley'd all in *Dutch*,  
And cry'd out *Yaw, yaw, yaw Myne Here*;  
But as the Draught they Drew  
They Stunck for fear, that *Monck*<sup>10</sup> was there,  
*Which cannot but be true.*  
\* \* \*

There's nothing done in all the World,  
From *Monarch* to the *Mouse*  
But every Day or Night 'tis hurld  
Into the *Coffee-house*.  
What *Lillie*<sup>11</sup> or what *Booker*<sup>12</sup> can  
By Art, not bring about,  
At *Coffee-house* you'll find a Man,  
*Can quickly find it out.*

They know who shall in times to come,  
Be either made, or undone,  
From great *St. Peters street* in *Rome*,  
To *Turnbull-street*<sup>13</sup> in *London*;  
\* \*

They know all that is Good, or Hurt,  
To Dam ye, or to Save ye;  
There is the *Colledge*, and the *Court*,  
The *Country*, *Camp* and *Navie*;  
So great a *Universitie*,  
I think there ne're was any;  
In which you may a Scholar be  
For spending of a Penny.  
\* \* \*

Here Men do talk of every Thing,  
With large and liberal Lungs,  
Like Women at a Gossiping,  
With double tyre of Tongues;

They'll give a Broad-side presently,  
Soon as you are in view,  
With Stories that, you'll wonder at,  
Which they will swear are true.

The Drinking there of *Chockalat*,  
Can make a *Fool* a *Sophie*;  
'Tis thought the *Turkish Mahomet*  
Was first Inspir'd with *Coffee*,  
By which his Powers did Over-flow  
The Land of *Palestine*;  
Then let us to the *Coffee-house* go,  
'Tis Cheaper farr then Wine.

You shall know there, what Fashions are;  
How Perrywiggs are Curl'd;  
And for a Penny you shall heare,  
All Novells in the World.  
Both Old and Young and Great and Small,  
And Rich, and Poore, you'll see;  
Therefore let's to the *Coffee* All,  
Come All away with Mee.

FINIS.

Robert Morton made a contribution to the controversy in *Lines Appended to the Nature, Quality and Most Excellent Vertues of Coffee* in 1670.

There was published in 1672 *A Broad-side Against Coffee, or the Marriage of the Turk*, verses that attained considerable fame because of their picturesque invective. They also stressed the fact that Pasqua Rosée's partner was a coachman, and imitated the broken English of the Ragusan youth:

A BROADSIDE AGAINST COFFEE;  
OR, THE  
MARRIAGE OF THE TURK

*Coffee*, a kind of *Turkish Renegade*,  
Has late a match with *Christian water* made;  
At first between them happen'd a Demur,  
Yet joyn'd they were, but not without great *stir*;  
\* \*

*Coffee* was cold as *Earth*, *Water* as *Thames*,  
And stood in need of recommending *Flames*;  
\* \*

*Coffee* so brown as berry does appear,  
Too swarthy for a Nymph so fair, so clear:  
\* \*

A Coachman was the first (here) *Coffee* made,  
And ever since the rest *drive on* the trade;

<sup>9</sup> The Dutch admiral who, in June, 1667, dashed into the Downs with a fleet of eighty "sail," and many "fire-ships", blocked up the mouths of the Mersey and Thames, destroyed the fortifications at Sheerness, cut away the paltry defenses of booms and chains drawn across the rivers, and got to Chatham, on the one side and nearly to Gravesend on the other, the king having spent in debauchery the money voted by Parliament for the proper support of the English navy.

<sup>10</sup> General Monk and Prince Rupert were at this time commanders of the English fleet.

<sup>11</sup> Lillie (Lilly) was the celebrated astrologer of the Protectorate, who earned great fame at that time by predicting, in June, 1645, "if now we fight, a victory stealeth upon us;" a lucky guess, signally verified in

the King's defeat at Naseby. Lilly thenceforth always saw the stars favourable to the Puritans.

<sup>12</sup> This man was originally a fishing-tackle maker in Tower Street during the reign of Charles I; but turning enthusiast, he went about prognosticating "the downfall of the King and Popery;" and as he and his predictions were all on the popular side, he became a great man with the superstitious "godly brethren" of that day.

<sup>13</sup> Turnball, or Turnbull-street, as it is still called, had been for a century previous of infamous repute. In Beaumont and Fletcher's play, the *Knight of the Burning Pestle*, one of the ladies who is undergoing penance at the barber's, has her character sufficiently pointed out to the audience, in her declaration, that she had been "stolen from her friends in Turnball-street."

Nature, Quality, and Most Excellent Vertues  
OF  
**COFFEE.**

*(The following text is a transcription of the main body of the 1670 broadside, detailing the medicinal properties of coffee.)*

**THE USES OF TEA**

*(The following text is a transcription of the section on Tea.)*

**THE VERTUES.**

*(The following text is a transcription of the section on the virtues of coffee.)*

A BROADSIDE OF 1670

*Me no good Engalash! and sure enough,  
He plaid the Quack to save his Stygian stuff;  
Ver boon for de stomach, de Cough, de Ptisick  
And I believe him, for it looks like Physick.  
Coffee a crust is charkt into a coal,  
The smell and taste of the Mock China bowl;  
Where huff and puff, they labour out their lungs,  
Lest Dives-like they should bewail their tongues.  
And yet they tell ye that it will not burn,  
Though on the Jury Blisters you return;  
Whose furious heat does make the water rise,  
And still through the Alembicks of your eyes.  
Dread and desire, ye fall to't snap by snap,  
As hungry Dogs do scalding porridge lap,  
But to cure Drunkards it has got great Fame;  
Posset or Porridge, will't not do the same?  
Confusion huddles all into one Scene,  
Like Noah's Ark, the clean and the unclean.  
But now, alas! the Drench has credit got,  
And he's no Gentleman that drinks it not;  
That such a Dwarf should rise to such a  
stature!  
But Custom is but a remove from Nature.  
A little Dish, and a large Coffee-house,  
What is it, but a Mountain and a Mouse?*

*Mens humana novitatis avidissima*

And so it came to pass that coffee history repeated itself in England. Many good people became convinced that coffee was a dangerous drink. The tirades against the beverage in that far-off time sound not unlike the advertising patter employed by

some of our present-day coffee-substitute manufacturers. It was even ridiculed by being characterized as "ninny broth" and "Turkey gruel."

A brief description of the excellent virtues of that sober and wholesome drink called coffee appeared in 1674 and proved an able and dignified answer to the attacks that had preceded it. That same year, for the first time in history, the sexes divided in a coffee controversy, and there was issued *The Women's Petition against Coffee, representing to public consideration the grand inconveniences accruing to their sex from the excessive use of the drying and enfeebling Liquor*, in which the ladies, who had not been accorded the freedom of the coffee houses in England, as was the custom in France, Germany, Italy, and other countries on the Continent, complained that coffee made men as "unfruitful as the deserts where that unhappy berry is said to be bought." Besides the more serious complaint that the whole race was in danger of extinction, it was urged that "on a domestic message a husband would stop by the way to drink a couple of cups of coffee."

This pamphlet is believed to have precipitated the attempt at suppression by the crown the following years, despite the

**A Broad-side against COFFEE;**  
Or, the  
**Marriage of the Turk.**

*(The following text is a transcription of the 1672 broadside, which satirizes coffee as a 'Turkish Rensade' and compares it to a 'Marriage of the Turk'.)*

Lond: Printed for J. L. Anno Dom. 1672.

A BROADSIDE OF 1672



prompt appearing, in 1674, of *The Men's Answer to the Women's Petition Against Coffee, vindicating their liquor, from the undeserved aspersion lately cast upon them, in their scandalous pamphlet.*

The 1674 broadside in defense of coffee was the first to be illustrated; and for all its air of pretentious grandeur and occasional bathos, it was not a bad rhyming advertisement for the persecuted drink. It was printed for Paul Greenwood and sold "at the sign of the coffee mill and tobacco-roll in Cloath-fair near West-Smithfield, who selleth the best Arabian coffee powder and chocolate in cake or roll, after the Spanish fashion, etc." The following extracts will serve to illustrate its epic character:

When the sweet Poison of the Treacherous Grape,  
Had Acted on the world a General Rape;  
Drowning our very Reason and our Souls  
In such deep Seas of large o'reflowing Bowls,  
\* \* \*

When Foggy Ale, leavying up mighty Trains  
Of muddy Vapours, had besieg'd our Brains;  
\* \* \*

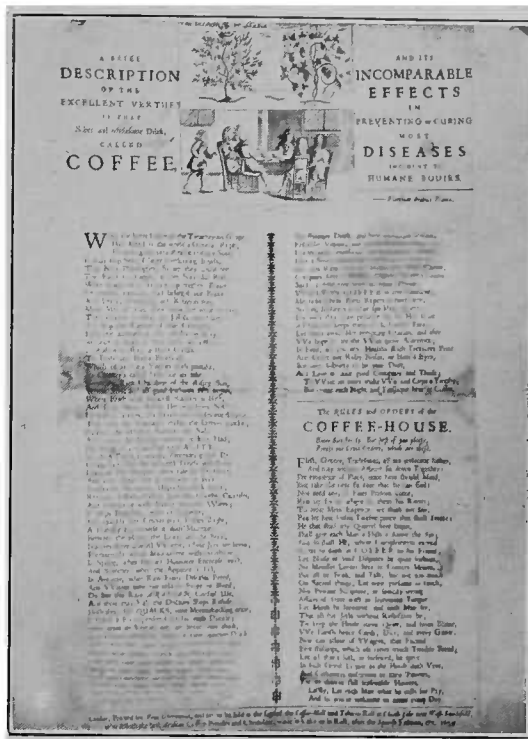
Then Heaven in Pity, to Effect our Cure,  
\* \* \*

First sent amongst us this *All-healing-Berry*,  
At once to make us both *Sober and Merry*.

*Arabian Coffee*, a Rich Cordial  
To Purse and Person Beneficial,  
Which of so many Vertues doth partake,  
Its Country's called Felix for its sake.  
From the Rich Chambers of the Rising Sun,  
Where Arts, and all good Fashions first begun,  
Where Earth with choicest Rarities is blest,  
And dying *Phoenix* builds Her wondrous Nest;  
COFFEE arrives, that Grave and Wholesome  
Liquor,  
That heals the Stomach, makes the Genius  
quicker,  
Relieves the Memory, Revives the Sad.  
\* \* \*

Do but this Rare ARABIAN Cordial Use,  
And thou may'st all the Doctors Slops Refuse.  
Hush then, dull QUACKS, your Mountebanking  
cease,  
COFFEE's a speedier Cure for each Disease;  
How great its Vertues are, we hence may think,  
The VVorlds third Part makes it their common  
Drink;  
In Breif, all you who Healths Rich Treasures  
Prize,  
And Court not Ruby Noses, or blear'd Eyes,  
But own Sobriety to be your Drift,  
And Love at once good Company and Thrift;  
To VVine no more make VVit and Coyn a  
Trophy,  
But come each Night and Frollique here in  
Coffee.

An eight-page folio, the last argument to be issued in defense of coffee before Charles II sought to follow in the footsteps of Kair Bey and Kuprili, was issued



A BROADSIDE OF 1674  
The first one to be illustrated

in the early part of 1675. It was entitled *Coffee Houses Vindicated. In answer to the late published Character of a Coffee House. Asserting from Reason, Experience and good Authors the Excellent Use and physical Virtues of that Liquor. . . With the Grand Conveniency of such civil Places of Resort and ingenious Conversation.*

The advantage of a coffee house compared with a "publick-house" is thus set forth:

First, In regard of easy expense. Being to wait for or meet a friend, a tavern-reckoning soon breeds a purse-consumption; in an ale house, you must gorge yourself with pot after pot. But here, for a penny or two, you may spend two or three hours, have the shelter of a house, the warmth of a fire, the diversion of company; and conveniency, if you please, of taking a pipe of tobacco; and all this without any grumbling or repining. Secondly. For sobriety. It is grown, by the ill influences of I know not what hydropick stars, almost a general custom amongst us, that no bargain can be drove, or business concluded between man and man, but it must be transacted at some publick-house . . . where continual sippings . . . would be apt to fly up into their brains and render them drowsy and indisposed . . . whereas, having now the opportunity of a coffee-house, they repair thither, take each man a dish or two (so far from causing, that it cures any dizziness, or disturbant fumes): and so, dispatching their business, go out more

sprightly about their affairs, than before. Lastly, For diversion where can young gentlemen, or shop-keepers, more innocently and advantageously spend an hour or two in the evening than at a coffee-house? Where they shall be sure to meet company, and, by the custom of the house, not such as at other places stingy and reserved to themselves, but free and communicative, where every man may modestly begin his story, and propose to, or answer another, as he thinks fit. So that, upon the whole matter, spight of the idle sarcasms and paltry reproaches thrown upon it, we may, with no less truth than plainness, give this brief character of a well-regulated coffee-house, (for our pen disdains to be an advocate for any sordid holes, that assume that name to cloke the practice of debauchery), that it is the sanctuary of health, the nursery of temperance, the delight of frugality, and academy of civility, and free-school of ingenuity.

*The Ale Wives' Complaint Against the Coffee-houses*, a dialogue between a victualer's wife and a coffee man, at difference about spiriting away each other's trade, also was issued in 1675.

As early as 1666, and again in 1672, we find the government planning to strike a blow at the coffee houses. By the year 1675, these "seminaries of sedition" were much frequented by persons of rank and substance, who, "suitable to our native genius," says Anderson, "used great freedom therein with respect to the courts' proceedings in these and like points, so contrary to the voice of the people."<sup>14</sup>

In 1672, Charles II, seemingly eager to emulate the Oriental intolerants that preceded him, determined to try his hand at suppression. "Having been informed of the great inconveniences arising from the great number of persons that resort to coffee-houses," the king "desired the Lord Keeper and the Judges to give their opinion in writing as to how far he might lawfully proceed against them."

Roger North in his *Examen* gives the full story; and D'Israeli, commenting on it, says, "it was not done without some apparent respect for the British constitution." The courts affected not to act against the law, and the judges were summoned to a consultation; but the five who met could not agree in opinion.

Sir William Coventry spoke against the proposed measure. He pointed out that the government obtained considerable revenue from coffee, that the king himself owed to these seemingly obnoxious places

<sup>14</sup> Anderson, Adam. *Historical and Chronological Deduction of the Origin of Commerce*. London, 1787.

no small debt of gratitude in the matter of his own restoration; for they had been permitted in Cromwell's time, when the king's friends had used more liberty of speech than "they dared to do in any other." He urged, also, that it might be rash to issue a command so likely to be disobeyed.

At last, being hard pressed for a reply, the judges gave such a halting opinion in favor of the king's policy as to remind us of the reluctant verdict wrung from the physicians and lawyers of Mecca on the occasion of coffee's first persecution.<sup>15</sup> "The English lawyers, in language which, for its civility and indefiniteness," says Robinson, "would have been the envy of their Eastern brethren," declared that:

Retailing coffee *might* be an innocent trade, as it *might* be exercised; but as it is used at present, in the nature of a common assembly, to discourse of matters of State, news and *great Persons*, as they are Nurseries of Idleness and Pragmaticalness, and hinder the expense of our native Provisions, they *might* be thought common nuisances.

An attempt was made to mold public opinion to a favorable consideration of the attempt at suppression in *The Grand Concern of England explained*, which was good propaganda for his majesty's enterprise, but utterly failed to carry conviction to the lovers of liberty.

After much backing and filling, the king, on December 23, 1675, issued a proclamation which in its title frankly stated its object—"for the suppression of coffee houses." It is here given in a somewhat condensed form:

BY THE KING: A PROCLAMATION  
FOR THE SUPPRESSION OF  
COFFEE HOUSES

Charles R.

WHEREAS, it is most apparent that the multitude of Coffee Houses of late years set up and kept within this kingdom, the dominion of Wales, and town of Berwick-upon-Tweed, and the great resort of Idle and disaffected persons to them, have produced very evil and dangerous effects; as well for that many tradesmen and others, do herein mispend much of their time, which might and probably would be employed in and about their Lawful Calling and Affairs; but also, for that in such houses divers false, malicious and scandalous reports are devised and spread abroad to the Defamation of his Majesty's Government, and to the Disturbance of the Peace and Quiet of the Realm; his Majesty hath thought fit and neces-

<sup>15</sup> See chapter II.

sary, that the said Coffee Houses be (for the future) Put down, and suppressed, and doth strictly charge and command all manner of persons, That they or any of them do not presume from and after the Tenth Day of January next ensuing, to keep any Public Coffee House, or to utter or sell by retail, in his, her or their house or houses (to be spent or consumed within the same) any Coffee, Chocolate, Sherbett or Tea, as they will answer the contrary at their utmost perils (all licenses to be revoked).

Given at our Court at Whitehall, this third-and-twentieth day of Dec., 1675, in the seven-and-twentieth year of our Reign.

GOD SAVE THE KING.

And then a remarkable thing happened. It is not usual for a royal proclamation issued on the 29th of one month to be recalled on the 8th day of the next; but this is the record established by Charles II. The proclamation was made on December 23, 1675, and issued December 29, 1675. It forbade the coffee houses to operate after January 10, 1676. But so intense was the feeling aroused, that eleven days was sufficient time to convince the king that a blunder had been made. Men of all parties cried out against being deprived of their accustomed haunts. The dealers in coffee, tea, and chocolate demonstrated that the proclamation would greatly lessen his majesty's revenues. Convulsion and discontent loomed large. The king heeded the warning, and on January 8, 1676, another proclamation was issued by which the first proclamation was recalled.

In order to save the king's face, it was solemnly recited that "His Gracious Majesty," out of his "princely consideration and royal compassion" would allow the retailers of coffee liquor to keep open until the 24th of the following June. But this was clearly only a royal subterfuge, as there was no further attempt at molestation, and it is extremely doubtful if any was contemplated at the time the second proclamation was promulgated.

"Than both which proclamations nothing could argue greater guilt nor greater weakness," says Anderson. Robinson remarks, "A battle for freedom of speech was fought and won over this question at a time when Parliaments were infrequent and when the liberty of the press did not exist."

#### "Penny Universities"

We read in 1677 that "none dare venture into the coffee houses unless he be

able to argue the question whether Parliament were dissolved or not."

All through the years remaining in the seventeenth century, and through most of the eighteenth century, the London coffee houses grew and prospered. As before stated, they were originally temperance institutions, very different from the taverns and ale houses. "Within the walls of the coffee house there was always much noise, much clatter, much bustle, but decency was never outraged."

At prices ranging from one to two pence per dish, the demand grew so great that coffee-house keepers were obliged to make the drink in pots holding eight or ten gallons.

The seventeenth-century coffee houses were sometimes referred to as the "penny universities"; because they were great schools of conversation, and the entrance fee was only a penny. Two pence was the usual price of a dish of coffee or tea, this charge also covering newspapers and lights. It was the custom for the frequenter to lay his penny on the bar, on entering or leaving. Admission to the exchange of sparkling wit and brilliant conversation was within the reach of all.

So great a *Universitie*  
I think there ne're was any;  
In which you may a Schoolar be  
For spending of a Penny.

"Regular customers," we are told, "had particular seats and special attention from the fair lady at the bar, and the tea and coffee boys."

It is believed that the modern custom of tipping, and the word "tip," originated in the coffee houses, where frequently hung brass-bound boxes, into which customers were expected to drop coins for the servants. The boxes were inscribed "To Insure Promptness" and from the initial letters of these words came "tip."

The *National Review* says, "before 1715 the number of coffee houses in London was reckoned at 2000." Dufour, who wrote in 1683, declares, upon information received from several persons who had staid in London, that there were 3000 of these places. However, 2000 is probably nearer the fact.

In that critical time in English history, when the people, tired of the misgovernment of the later Stuarts, were most in need of a forum where questions of great moment could be discussed, the coffee house

became a sanctuary. Here matters of supreme political import were threshed out and decided for the good of Englishmen for all time. And because many of these questions were so well thought out then, there was no need to fight them out later. England's great struggle for political liberty was really fought and won in the coffee house.

To the end of the reign of Charles II, coffee was looked upon by the government rather as a new check upon license than an added luxury. After the revolution, the London coffee merchants were obliged to petition the House of Lords against new import duties, and it was not until the year 1692 that the government, "for the greater encouragement and advancement of trade and the greater importation of the said respective goods or merchandises," discharged one half of the obnoxious tariff.

#### *Weird Coffee Substitutes*

Shortly after the "great fire," coffee substitutes began to appear. First came a liquor made with betony, "for the sake of those who could not accustom themselves to the bitter taste of coffee." Betony is an herb belonging to the mint family, and its root was formerly employed in medicine as an emetic or purgative. In 1719, when coffee was 7s. a pound, came bocket, later known as saloop, a decoction of sassafras and sugar, that became such a favorite among those who could not afford tea or coffee, that there were many saloop stalls in the streets of London. It was also sold at Read's coffee house in Fleet Street.

#### *The Coffee Men Overreach Themselves*

The coffee-house keepers had become so powerful a force in the community by 1729 that they lost all sense of proportion; and we find them seriously proposing to usurp the functions of the newspapers. The vain-glorious coffee men requested the government to hand over to them a journalistic monopoly; the argument being that the newspapers of the day were choked with advertisements, filled with foolish stories gathered by all-too enterprising newswriters, and that the only way for the government to escape "further excesses occasioned by the freedom of the press" and to rid itself of "those pests of society, the

unlicensed newsvendors," was for it to intrust the coffee men, as "the chief supporters of liberty," with the publication of a *Coffee House Gazette*. Information for the journal was to be supplied by the habitués of the houses themselves, written down on brass slates or ivory tablets, and called for twice daily by the *Gazette's* representatives. All the profits were to go to the coffee men—including the expected increase of custom.

Needless to say, this amazing proposal of the coffee-house masters to have the public write its own newspapers met with the scorn and the derision it invited, and nothing ever came of it.

The increasing demand for coffee caused the government tardily to seek to stimulate interest in the cultivation of the plant in British colonial possessions. It was tried out in Jamaica in 1730. By 1732 the experiment gave such promise that Parliament, "for encouraging the growth of coffee in His Majesty's plantations in America," reduced the inland duty on coffee coming from there, "but of none other," from two shillings to one shilling six pence per pound. "It seems that the French at Martinico, Hispaniola, and at the Isle de Bourbon, near Madagascar, had somewhat the start of the English in the new product, as had also the Dutch at Surinam, yet none had hitherto been found to equal coffee from Arabia, whence all the rest of the world had theirs." Thus writes Adam Anderson in 1787, somewhat ungraciously seeking to damn England's business rivals with faint praise. Java coffee was even then in the lead, and the seeds of Bourbon-Santos were multiplying rapidly in Brazilian soil.

The British East India Company, however, was much more interested in tea than in coffee. Having lost out to the French and Dutch on the "little brown berry of Arabia," the company engaged in so lively a propaganda for "the cup that cheers" that, whereas the annual tea imports from 1700 to 1710 averaged 800,000 pounds, in 1721 more than 1,000,000 pounds of tea were brought in. In 1757, some 4,000,000 pounds were imported. And when the coffee house finally succumbed, tea, and not coffee, was firmly entrenched as the national drink of the English people.

A movement in 1873 to revive the coffee house in the form of a coffee "palace," designed to replace the public house as a

place of resort for working men, caused the Edinburgh Castle to be opened in London. The movement attained considerable success throughout the British Isles, and even spread to the United States.

#### *Evolution of the Club*

Every profession, trade, class, and party had its favorite coffee house. "The bitter black drink called coffee," as Mr. Pepys described the beverage, brought together all sorts and conditions of men; and out of their mixed association there developed groups of patrons favoring particular houses and giving them character. It is easy to trace the transition of the group into a clique that later became a club, continuing for a time to meet at the coffee house or the chocolate house, but eventually demanding a house of its own.

#### *Decline and Fall of the Coffee House*

Starting as a forum for the commoner, the coffee house soon became the plaything of the leisure class; and when the club was evolved, the coffee house began to retrograde to the level of the tavern. And so the eighteenth century, which saw the coffee house at the height of its power and popularity, witnessed also its decline and fall. It is said there were as many clubs at the end of the century as there were coffee houses at the beginning.

For a time, when the habit of reading newspapers descended the social ladder, the coffee house acquired a new lease of life. Sir Walter Besant observes:

They were then frequented by men who came not to talk, but to read; the smaller tradesmen and the better class of mechanic now came to the coffee-house, called for a cup of coffee, and with it the daily paper, which they could not afford to take in. Every coffee-house took three or four papers; there seems to have been in this latter phase of the once social institution no general conversation. The coffee-house as a place of resort and conversation gradually declined; one can hardly say why, except that all human institutions do decay. Perhaps manners declined; the leaders in literature ceased to be seen there; the city clerk began to crowd in; the tavern and the club drew men from the coffee-house.

A few houses survived until the early years of the nineteenth century, but the social side had disappeared. As tea and coffee entered the homes, and the exclusive club house succeeded the democratic coffee

forum, the coffee houses became taverns or chop houses, or, convinced that they had outlived their usefulness, just ceased to be.

#### *Pen Pictures of Coffee-House Life*

From the writings of Addison in the *Spectator*, Steele in the *Tatler*, Mackay in his *Journey Through England*, Macaulay in his history, and others, it is possible to draw a fairly accurate pen-picture of life in the old London coffee house.

In the seventeenth century the coffee room usually opened off the street. At first only tables and chairs were spread about on a sanded floor. Later, this arrangement was succeeded by the boxes, or booths, such as appear in the Rowlandson caricatures, the picture of the interior of Lloyds, etc.

The walls were decorated with handbills and posters advertising the quack medicines, pills, tinctures, salves, and electuaries of the period, all of which might be purchased at the bar near the entrance, presided over by a prototype of the modern English barmaid. There were also bills of the play, auction notices, etc., depending upon the character of the place.

Then, as now, the barmaids were made much of by patrons. Tom Brown refers to them as charming "Phillises who invite you by their amorous glances into their smoaky territories."

Messages were left and letters received at the bar for regular customers. Stella was instructed to address her letters to Swift, "under cover to Addison at the St. James's coffee house." Says Macaulay:

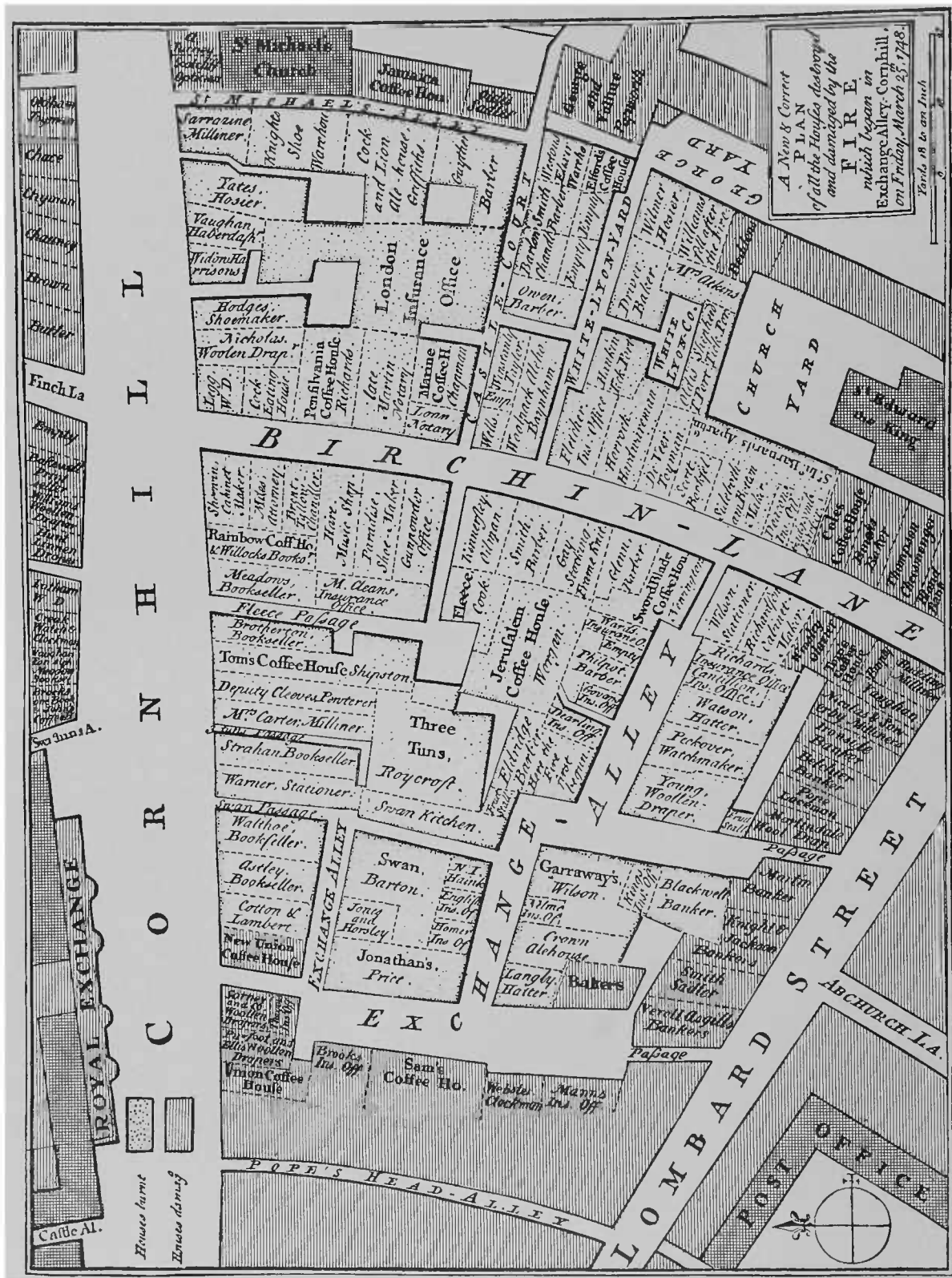
Foreigners remarked that it was the coffee house which specially distinguished London from all other cities; that the coffee house was the Londoner's home, and that those who wished to find a gentleman commonly asked, not whether he lived in Fleet Street or Chancery Lane, but whether he frequented the Grecian or the Rainbow.

So every man of the upper or middle classes went daily to his coffee house to learn the news and to discuss it. The better class houses were the meeting places of the most substantial men in the community. Every coffee house had its orator, who became to his admirers a kind of "fourth estate of the realm."

Macaulay gives us the following picture of the coffee house of 1685:

Nobody was excluded from these places who laid down his penny at the bar. Yet every





MAP SHOWING THE LOCATION OF MANY OF THE OLD LONDON COFFEE HOUSES PREVIOUS TO THE FIRE OF 1748

rank and profession, and every shade of religious and political opinion had its own headquarters.

There were houses near St. James' Park, where fops congregated, their heads and shoulders covered with black or flaxen wigs, not less ample than those which are now worn by the Chancellor and by the Speaker of the House of Commons. The atmosphere was like that of a perfumer's shop. Tobacco in other form than that of richly scented snuff was held in abomination. If any clown, ignorant of the usages of the house, called for a pipe, the sneers of the whole assembly and the short answers of the waiters soon convinced him that he had better go somewhere else.

Nor, indeed, would he have far to go. For, in general, the coffee-houses reeked with tobacco like a guard room. Nowhere was the smoking more constant than at Will's. That celebrated house, situated between Covent Garden and Bow street, was sacred to polite letters. There the talk was about poetical justice and the unities of place and time. Under no roof was a greater variety of figures to be seen. There were earls in stars and garters, clergymen in cassocks and bands, pert Templars, sheepish lads from universities, translators and index makers in ragged coats of frieze. The great press was to get near the chair where John Dryden sate. In winter that chair was always in the warmest nook by the fire; in summer it stood in the balcony. To bow to the Laureate, and to hear his opinion of Racine's last tragedy, or of Bossu's treatise on epic poetry, was thought a privilege. A pinch from his snuff-box was an honour sufficient to turn the head of a young enthusiast.

There were coffee-houses where the first medical men might be consulted. Dr. John Radcliffe, who, in the year, 1685, rose to the largest practice in London, came daily, at the hour when the Exchange was full, from his house in Bow street, then a fashionable part of the capital, to Garraway's, and was to be found, surrounded by surgeons and apothecaries, at a particular table.

There were Puritan coffee-houses where no oath was heard, and where lank-haired men discussed election and reprobation through their noses; Jew coffee-houses, where dark-eyed money changers from Venice and Amsterdam greeted each other; and Popish coffee-houses, where, as good Protestants believed, Jesuits planned over their cups another great fire, and cast silver bullets to shoot the king.

Ned Ward gives us this picture of the coffee house of the seventeenth century. He is describing Old Man's, Scotland Yard:

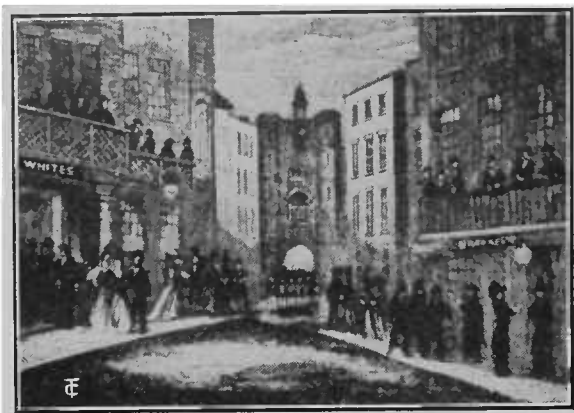
We now ascended a pair of stairs, which brought us into an old-fashioned room, where a gaudy crowd of odoriferous Tom-Essences were walking backwards and forwards, with their hats in their hands, not daring to convert them to their intended use lest it should put the fore-tops of their wigs into some disorder. We squeezed through till we got to the end of the room, where, at a small table, we sat down, and observed that it was as great a rarity to hear anybody call for a dish of politicians por-

ridge, or any other liquor, as it is to hear a beau call for a pipe of tobacco; their whole exercise being to charge and discharge their nostrils and keep the curls of their periwigs in their proper order. The clashing of their snuff-box lids, in opening and shutting, made more noise than their tongues. Bows and cringes of the newest mode were here exchanged 'twixt friend and friend with wonderful exactness. They made a humming like so many hornets in a country chimney, not with their talking, but with their whispering over their new Minuets and Bories, with the hands in their pockets, if only freed from their snuff-box. We now began to be thoughtful of a pipe of tobacco, where-upon we ventured to call for some instruments of evaporation, which were accordingly brought us, but with such a kind of unwillingness, as if they would much rather been rid of our company; for their tables were so very neat, and shined with rubbing like the upper-leathers of an alderman's shoes, and as brown as the top of a country house-wife's cupboard. The floor was as clean swept as a Sir Courtly's dining room, which made us look round to see if there were no orders hung up to impose the forfeiture of so much mop-money upon any person that should spit out of the chimney-corner. Notwithstanding we wanted an example to encourage us in our porterly rudeness, we ordered them to light the wax candle, by which we ignited our pipes and blew about our whiffs; at which several Sir Fopplins drew their faces into as many peevish wrinkles as the beaux at the Bow Street Coffee-house, near Covent Garden, did when the gentleman in masquerade came in amongst them, with his oyster-barrel muff and turnip-buttons, to ridicule their foperies.

In *A Brief and Merry History of Great Britain* we read:

There is a prodigious number of Coffee-Houses in London, after the manner I have seen some in Constantinople. These Coffee-Houses are the constant Rendezvous for Men of Business as well as the idle People. Besides Coffee, there are many other Liquors, which People cannot well relish at first. They smook Tobacco, game and read Papers of Intelligence; here they treat of Matters of State, make Leagues with Foreign Princes, break them again, and transact Affairs of the last Consequence to the whole World. They represent these Coffee-Houses as the most agreeable things in London, and they are, in my Opinion, very proper Places to find People that a Man has Business with, or to pass away the Time a little more agreeably than he can do at home; but in other respects they are loathsome, full of smook, like a Guard-Room, and as much crowded. I believe 'tis these Places that furnish the Inhabitants with Slander, for there one hears exact Account of everything done in Town, as if it were but a Village.

At those Coffee-Houses, near the Courts, called White's, St. James's, Williams's, the Conversation turns chiefly upon the Equipages, Essence, Horse-Matches, Tupees, Modes and Mortgages; the Cocoa-Tree upon Bribery and Corruption, Evil ministers, Errors and Mistakes in Govern-



WHITE'S AND BROOKES', ST. JAMES'S STREET

ment; the Scotch Coffee-Houses towards Charing Cross, on Places and Pensions; the Tiltyard and Young Man's on Affronts, Honour, Satisfaction, Duels' and Rencounters. I was informed that the latter happen so frequently, in this part of the Town, that a Surgeon and a Solicitor are kept constantly in waiting; the one to dress and heal such Wounds as may be given, and the other in case of Death to bring off the Survivor with a Verdict of *Se Devendendo* or Manslaughter. In those Coffee-Houses about the Temple the Subjects are generally on Causes, Costs, Demurrers, Rejoinders and Exceptions; Daniel's the Welch Coffee-House in Fleet Street, on Births, Pedigrees and Descents; Child's and the Chapter upon Glebes, Tithes, Advowsons, Rectories and Lectureships; North's Undue Elections, False Polling, Scrutinies, etc., Hamlin's, Infant-Baptism, Lay-Ordination, Free-Will, Election and Reprobation; Batson's, the Prices of Pepper, Indigo and Salt-Petre; and all those about the Exchange, where the Merchants meet to transact their Affairs, are in a perpetual hurry about Stock-Jobbing, Lying, Cheating, Tricking Widows and Orphans, and committing Spoil and Rapine on the Publick.

In the eighteenth century beer and wine were commonly sold at the coffee houses in addition to tea and chocolate. Daniel Defoe, writing of his visit to Shrewsbury in 1724, says, "I found there the most coffee houses around the Town Hall that ever I saw in any town, but when you come into them they are but ale houses, only they think that the name coffee house gives a better air."

Speaking of the coffee houses of the city, Besant says:

Rich merchants alone ventured to enter certain of the coffee houses, where they transacted business more privately and more expeditiously than on the Exchange. There were coffee houses where officers of the army alone were found; where the city shopkeeper met his chums; where actors congregated; where only divines, only lawyers, only physicians, only wits and those who came to hear them were found. In all alike the visitor put down his penny and went

in, taking his own seat if he was an habitue; he called for a cup of tea or coffee and paid his twopence for it; he could call also, if he pleased, for a cordial; he was expected to talk with his neighbour whether he knew him or not. Men went to certain coffee houses in order to meet the well-known poets and writers who were to be found there, as Pope went in search of Dryden. The daily papers and the pamphlets of the day were taken in. Some of the coffee houses, but not the more respectable, allowed the use of tobacco.

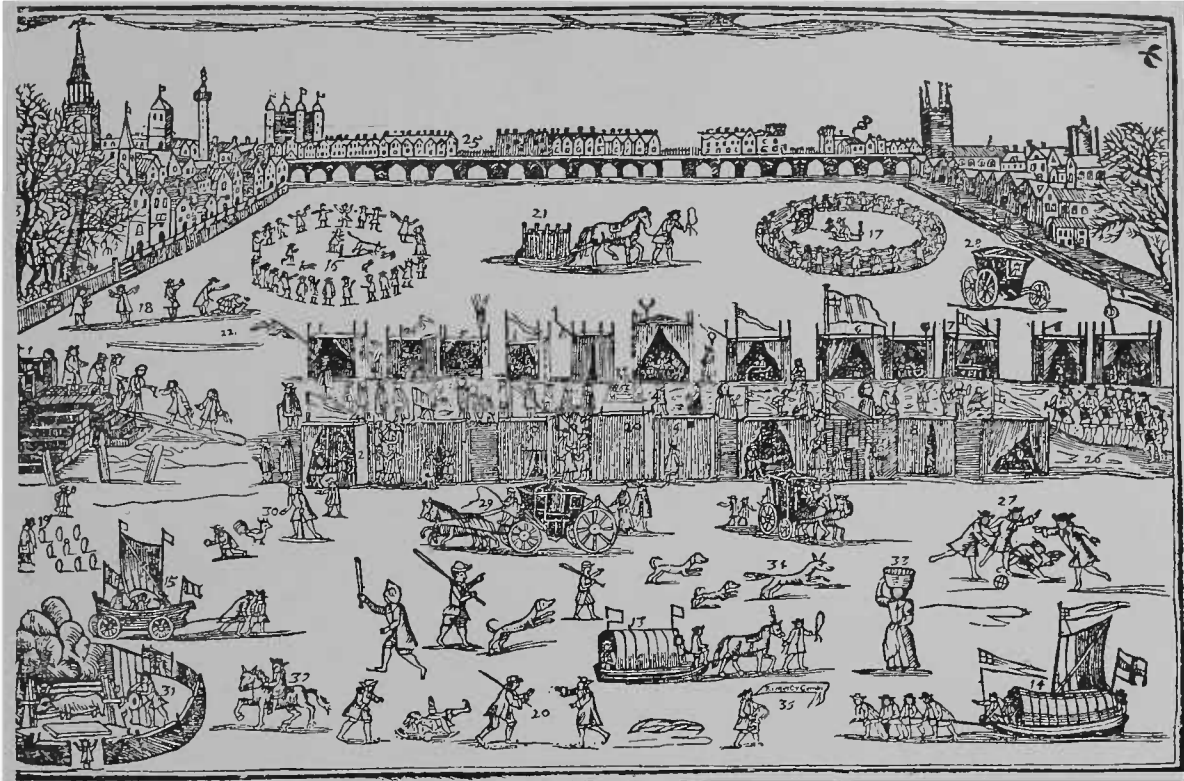
Mackay, in his *Journey Through England* (1724), says:

We rise by nine, and those that frequent men's levees find entertainment at them till eleven, or, as in Holland, go to tea-tables; about twelve the *beau monde* assemble in several coffee or chocolate houses; the best of which are the Cocotree and White's chocolate houses, St. James', the Smyrna, Mrs. Rochford's and the British coffee houses; and all these so near one another that in less than an hour you see the company of them all. We are carried to these places in chairs (or sedans), which are here very cheap, a guinea a week, or a shilling per hour, and your chairmen serve you for porters to run on errands, as your gondoliers do at Venice.

If it be fine weather we take a turn into the park till two, when we go to dinner; and if it be dirty, you are entertained at picquet or basset at White's, or you may talk politics at



COFFEE HOUSE POLITICIANS OF THE SEVENTEENTH CENTURY



THE GREAT FAIR ON THE FROZEN THAMES—1683

From a broadside entitled *Wonders on the Deep*. Figure 2 is the Duke of York's Coffee House

the Smyrna or St. James'. I must not forget to tell you that the parties have their different places, where, however, a stranger is always well received; but a Whig will no more go to the Cocotree than a Tory will be seen at the Coffee House, St. James'.

The Scots go generally to the British, and a mixture of all sorts go to the Smyrna. There are other little coffee houses much frequented in this neighborhood—Young Man's for officers; Old Man's for stock jobbers, paymasters and courtiers, and Little Man's for sharpers. I never was so confounded in my life as when I entered into this last. I saw two or three tables full at faro, and was surrounded by a set of sharp faces that I was afraid would have devoured me with their eyes. I was glad to drop two or three half crowns at faro to get off with a clear skin, and was overjoyed I so got rid of them.

At two we generally go to dinner; ordinaries are not so common here as abroad, yet the French have set up two or three good ones for the convenience of foreigners in Suffolk street, where one is tolerably well served; but the general way here is to make a party at the coffee house to go to dine at the tavern, where we sit till six, when we go to the play, except you are invited to the table of some great man, which strangers are always courted to and nobly entertained.

Mackay writes that "in all the coffee houses you have not only the foreign prints but several English ones with foreign oc-

currences, besides papers of morality and party disputes."

"After the play," writes Defoe, "the best company generally go to Tom's and Will's coffee houses, near adjoining, where there is playing at picquet and the best of conversation till midnight. Here you will see blue and green ribbons and stars sitting familiarly and talking with the same freedom as if they had left their equality and degrees of distance at home."

Men had their coffee houses as now they have their clubs—sometimes contented with one, sometimes belonging to three or four. Johnson, for instance, was connected with St. James's, the Turk's Head, the Bedford, Peele's, besides the taverns which he frequented. Addison and Steele used Button's; Swift, Button's, the Smyrna, and St. James's; Dryden, Will's; Pope, Will's and Button's; Goldsmith, the St. James's and the Chapter; Fielding, the Bedford; Hogarth, the Bedford and Slaughter's; Sheridan, the Piazza; Thurlow, Nando's.

That traffic in slaves was occasionally included among the many activities of the London coffee houses is indicated by Mr. J. A. Findlay in his *Short History of the*



*Baltic Exchange*, which quotes two newspaper advertisements from the *London Daily Journal* in 1728. The first offers two guineas reward for notice left at the bar of the Jamaica Coffee House of the whereabouts of a negro woman who ran away from her owner in Blackheath, and the second announces, "To Be Sold—A negro boy, aged about 11 years. Enquire at the Virginia Coffee House in Threadneedle street, behind the Royal Exchange."

#### *Some Famous Coffee Houses*

Among the famous English coffee houses of the seventeenth-eighteenth century period were St. James's, Will's, Garraway's, White's, Slaughter's, the Grecian, Button's, Lloyd's, Tom's, and Don Saltero's.

St. James's was a Whig house frequented by members of Parliament, with a fair sprinkling of literary stars. Garraway's catered to the gentry of the period, many of whom naturally had Tory proclivities.

One of the notable coffee houses of Queen Anne's reign was Button's. Here Addison could be found almost every after-

noon and evening, along with Steele, Davenant, Carey, Philips, and other kindred minds. Pope was a member of the same coffee house club for a year, but his inborn irascibility eventually led him to drop out of it.

At Button's a lion's head, designed by Hogarth after the Lion of Venice, "a proper emblem of knowledge and action, being all head and paws," was set up to receive letters and papers for the *Guardian*.<sup>16</sup> The *Tatler* and the *Spectator* were born in the coffee house, and probably English prose would never have received the impetus given it by the essays of Addison and Steele had it not been for coffee house associations.

Pope's famous *Rape of the Lock* grew out of coffee-house gossip. The poem itself contains one charming passage on coffee.<sup>17</sup>

Other frequenters of the coffee houses of the period were Daniel Defoe, Henry Fielding, Thomas Gray, and Richard Brinsley Sheridan. Garrick was often to be seen at Tom's in Birchin Lane, where also Chatterton might have been found on many an evening before his untimely death.

#### *The London Pleasure Gardens*

In the second half of the eighteenth century, during the reigns of the Georges, the coffee houses were still an important factor in London life, but were influenced somewhat by the development of gardens in which were served tea, chocolate, and other drinks, as well as coffee. At the coffee houses themselves, while coffee remained the favorite beverage, the proprietors, in the hope of increasing their patronage, began to serve wine, ale, and other liquors. This seems to have been the first step toward the decay of the coffee house.

The coffee houses, however, continued to be the centers of intellectual life. When Samuel Johnson and David Garrick came together to London, literature was temporarily in a bad way, and the hack writers of the time dwelt in Grub Street.

It was not until after Johnson had met with some success, and had established the first of his coffee-house clubs at the Turk's Head, that literature again became a fashionable profession.

This really famous literary club met at the Turk's Head from 1763 to 1783.



THE LION'S HEAD AT BUTTON'S COFFEE HOUSE  
Designed by Hogarth, and put up by Addison, 1713  
From a water color by T. H. Shepherd

<sup>16</sup> More fully described in chapter XXXVII.

<sup>17</sup> See chapter XXXVII.





## A TRIO OF NOTABLES AT BUTTON'S IN 1730

The figure in the cloak is Count Viviani; of the figures facing the reader, the draughts player is Dr. Arbuthnot, and the figure standing is assumed to be Pope

Among the most notable members were Johnson, the arbiter of English prose; Oliver Goldsmith; Boswell, the biographer; Burke, the orator; Garrick, the actor; and Sir Joshua Reynolds, the painter. Among the later members were Gibbon, the historian; and Adam Smith, the political economist.

Certain it is that during the sway of the English coffee house, and at least partly through its influence, England produced a better prose literature, as embodied alike in her essays, literary criticisms, and novels, than she ever had produced before.

The advent of the pleasure garden brought coffee out into the open in England; and one of the reasons why gardens, such as Ranelagh and Vauxhall, began to be more frequented than the coffee houses was that they were popular resorts for women as well as for men. All kinds of beverages were served in them; and soon

the women began to favor tea as an afternoon drink. At least, the great development in the use of tea dates from this period; and many of these resorts called themselves tea gardens.

The use of coffee by this time, however, was well established in the homes as a breakfast and dinner beverage, and such consumption more than made up for any loss sustained through the gradual decadence of the coffee house. Yet signs of the change in national taste that arrived with the Georges were not wanting; for the active propaganda of the British East India Company was fairly well launched during Queen Anne's reign.

The London pleasure gardens of the eighteenth century were unique. At one time there was a "mighty maze" of them. Their season extended from April or May to August or September. At first there was no charge for admission, but Warwick

Wroth tells us that visitors usually purchased cheese cakes, syllabubs, tea, coffee, and ale.<sup>18</sup>

The four best-known London gardens were Vauxhall; Marylebone; Cuper's, where the charge for admission subsequently was fixed at not less than a shilling; and Ranelagh, where the charge of half a crown included "the Elegant Regale" of tea, coffee, and bread and butter.

The pleasure gardens provided walks, rooms for dancing, skittle grounds, bowling greens, variety entertainments, and promenade concerts; and not a few places were given over to fashionable gambling and racing.

The Vauxhall Gardens, one of the most favored resorts of pleasure-seeking Londoners, were located on the Surrey side of the Thames, a short distance east of Vauxhall Bridge. They were originally known as the New Spring Gardens (1661), to distinguish them from the old Spring Gardens at Charing Cross. They became famous in the reign of Charles II. Vauxhall was celebrated for its walks, lit with

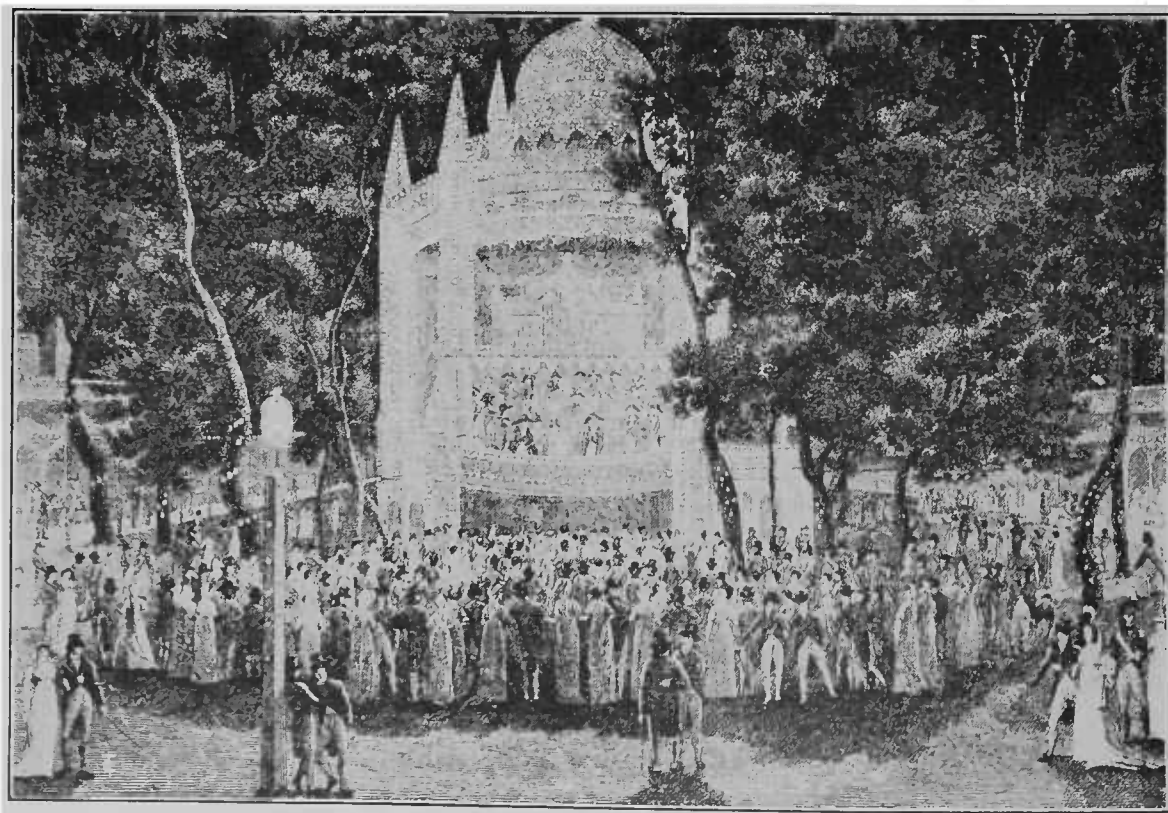
thousands of lamps, its musical and other performances, suppers, and fireworks. High and low were to be found there, and the drinking of tea and coffee in the arbors was a feature. The illustration shows the garden brightly illuminated by lanterns and lamps on some festival occasion. Coffee and tea were served in the arbors.

The Ranelagh, "a place of public entertainment," erected at Chelsea in 1742, was a kind of Vauxhall under cover. The principal room, known as the Rotunda, was circular in shape, 150 feet in diameter, and had an orchestra in the center and tiers of boxes all around. Promenading and taking refreshments in the boxes were the principal diversions. Except on gala nights of masquerades and fireworks, only tea, coffee, and bread and butter were to be had at Ranelagh.

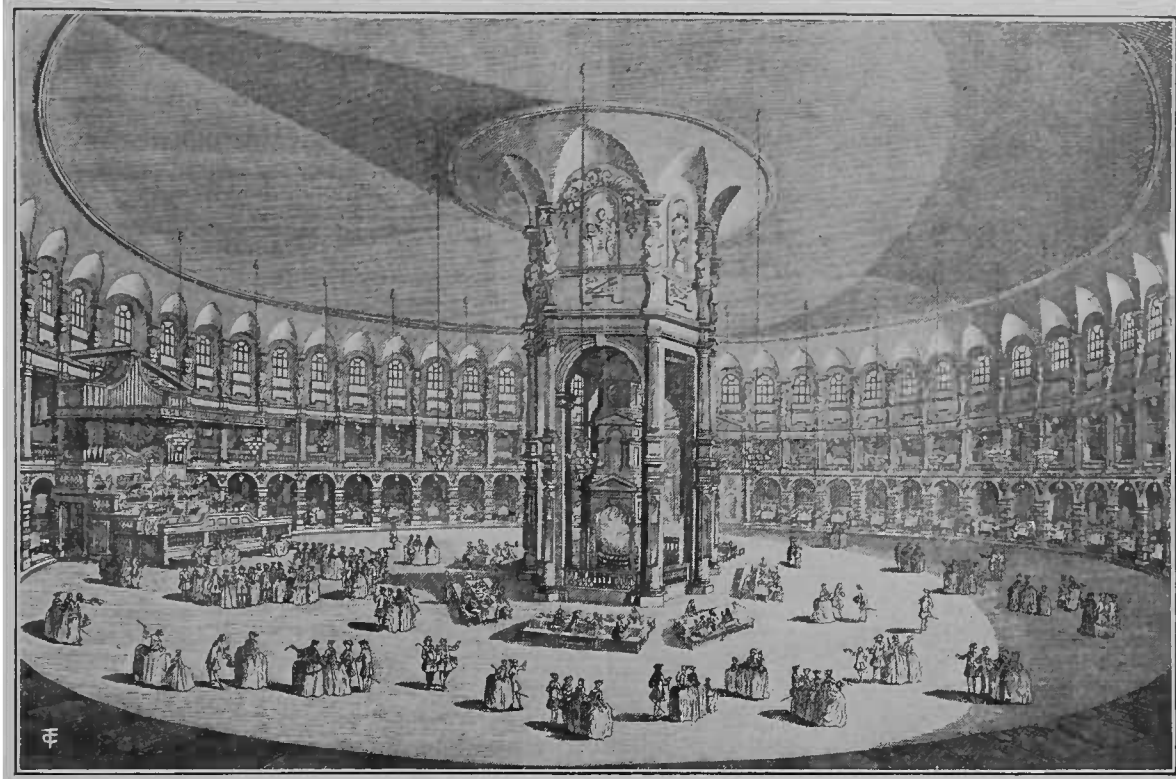
In the group of gardens connected with mineral springs was the Dog and Duck (St. George's Spa), which finally became a tea garden and a dancing saloon of doubtful repute.

Still another division, recognized by Wroth, consisted mainly of tea gardens, among them Highbury Barn, The Canon-

<sup>18</sup> Wroth, Warwick. *The London Pleasure Gardens of the 18th Century*. London, 1896.



VAUXHALL GARDENS ON A GALA NIGHT



THE ROTUNDA IN RANELAGH GARDENS WITH THE COMPANY AT BREAKFAST—1751

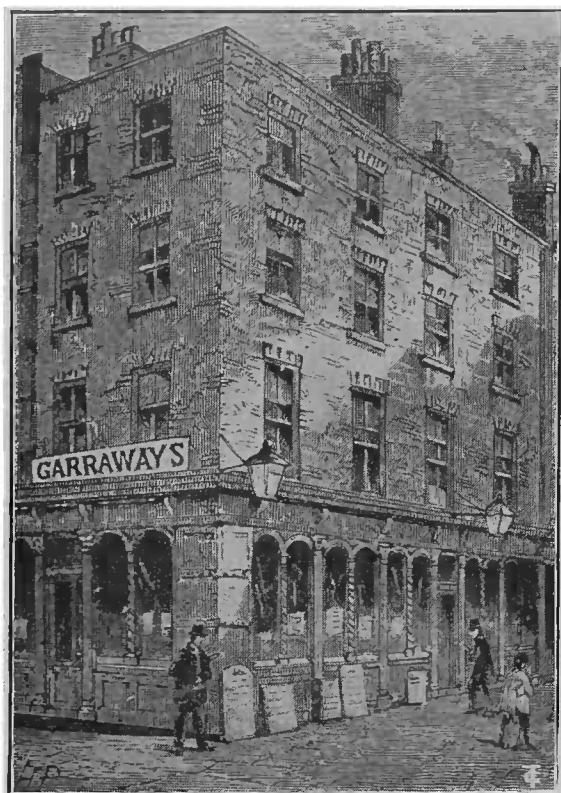
bury House, Hornsey and Copenhagen House, Bagnigge Wells, and White Conduit House. The two last named were the classic tea gardens of the period. Both were provided with "long rooms" in case of rain, and for indoor promenades with organ music. Then there were the Adam and Eve tea gardens, with arbors for tea-drinking parties, which subsequently became the Adam and Eve Tavern and Coffee House. Well known were the Bayswater Tea Gardens and the Jews Harp House and Tea Gardens. All these were provided with neat, "genteel" boxes, let into the hedges and alcoves, for tea and coffee drinkers.

#### *Locating the Notable Coffee Houses*

GARRAWAY'S, 3 'Change Alley, Cornhill, was a place for great mercantile transactions. Thomas Garway, the original proprietor, was a tobacconist and coffee man, who claimed to be the first that sold tea in England, although not at this address. The later Garraway's was long famous as a sandwich and drinking room for sherry, pale ale, and punch, in addition to tea and coffee. It is said that the sandwich-maker

was occupied two hours in cutting and arranging the sandwiches for the day's consumption. After the Great Fire of 1666 GARRAWAY'S moved into the same place in Exchange Alley where Elford had been before the fire. Here he claimed to have the oldest coffee house in London; but the ground on which BOWMAN'S had stood was occupied later by the VIRGINIA and the JAMAICA coffee houses. The latter was damaged by the fire of 1748 which consumed GARRAWAY'S and ELFORD'S (see map on page 72).

WILL'S, the predecessor of BUTTON'S, first had the title of the RED COW, then of the ROSE. It was kept by William Urwin, and was on the north side of Russell Street at the corner of Bow Street. "It was Dryden who made Will's coffee house the great resort of the wits of his time." (*Pope and Spence.*) The room in which the poet was accustomed to sit was on the first floor; and his place was the place of honor by the fireside in the winter, and at the corner of the balcony, looking over the street, in fine weather; he called the two places his winter and his summer seats. This was called the dining-room floor. The company did not sit in boxes as subsequently, but at



GARRAWAY'S COFFEE HOUSE IN 'CHANGE ALLEY  
Garway (or Garraway) claimed to have been first  
to sell Tea in England

various tables which were dispersed through the room. Smoking was permitted in the public room; it was then so much in vogue that it does not seem to have been considered a nuisance. Here, as in other similar places of meeting, the visitors divided themselves into parties; and we are told by Ward that the young beaux and wits, who seldom approached the principal table, thought it a great honor to have a pinch out of Dryden's snuff-box. After Dryden's death WILL'S was transferred to a house opposite, and became BUTTON'S, "over against THOMAS'S in Covent Garden." Thither also Addison transferred much company from THOMAS'S. Here Swift first saw Addison. Hither also came "Steele, Arbuthnot and many other wits of the time." BUTTON'S continued in vogue until Addison's death and Steele's retirement into Wales, after which the coffee drinkers went to the BEDFORD, dinner parties to the SHAKESPEARE. BUTTON'S was subsequently known as the CALEDONIEN.

SLAUGHTER'S, famous as the resort of painters and sculptors in the eighteenth century, was situated at the upper end of the west side of St. Martin's Lane. Its

first landlord was Thomas Slaughter, 1692. A second SLAUGHTER'S (NEW SLAUGHTER'S) was established in the same street in 1760, when the original SLAUGHTER'S adopted the name of OLD SLAUGHTER'S. It was torn down in 1843-44. Among the notables who frequented it were Hogarth; young Gainsborough; Cipriani; Haydon; Roubiliac; Hudson, who painted the Dilettanti portraits; M'Ardell, the mezzotint-scraper; Luke Sullivan, the engraver; Gardell, the portrait painter; and Parry, the Welsh harper.

Tom's, in Birchin Lane, Cornhill, though in the main a mercantile resort, acquired some celebrity from having been frequented by Garrick. Tom's was also frequented by Chatterton, as a place "of the best resort." Then there was TOM'S in Devereux Court, Strand, and Tom's at 17 Great Russell Street, Covent Garden, opposite BUTTON'S, a celebrated resort during the reign of Queen Anne and for more than a century after.

THE GRECIAN, Devereux Court, Strand,

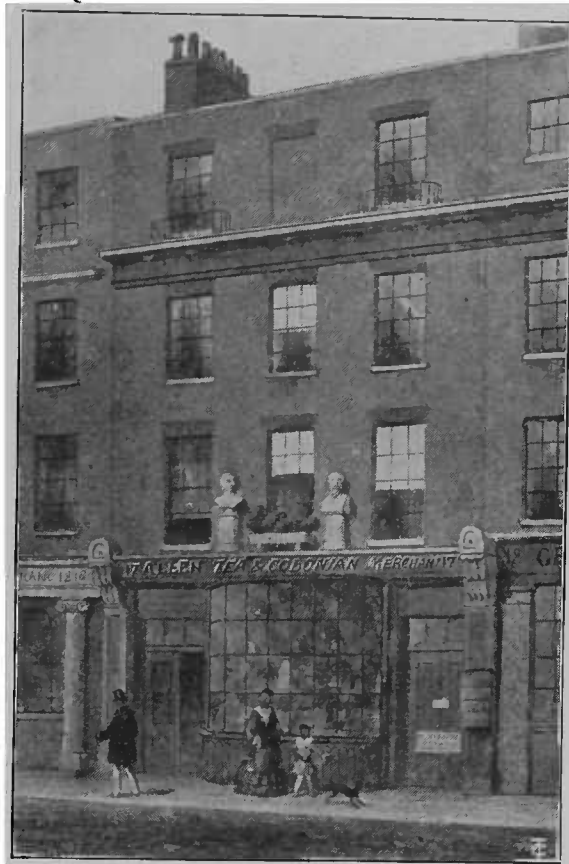


THE CALEDONIEN IN GREAT RUSSELL STREET  
Previously known as Button's Coffee House  
From a water color by T. H. Shepherd

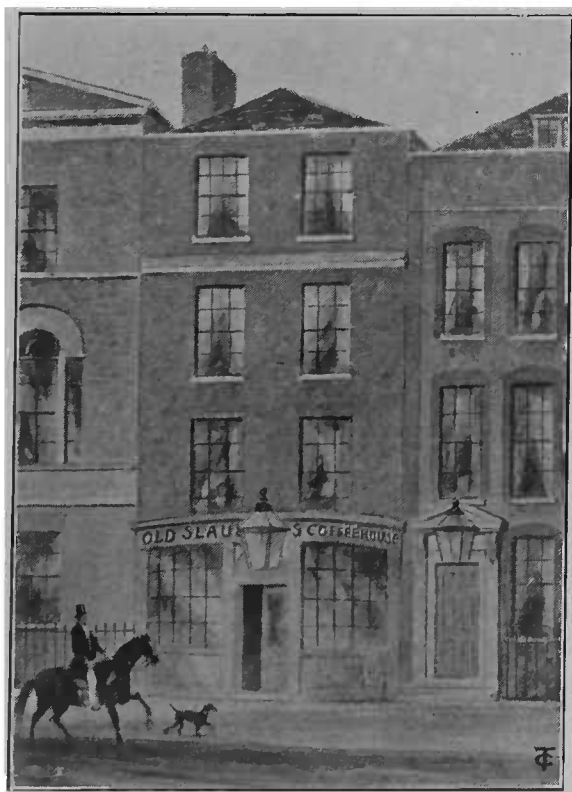


was originally kept by one Constantine, a Greek. From this house Steele proposed to date his learned articles in the *Tatler*; it is mentioned in No. 1 of the *Spectator*, and it was much frequented by Goldsmith. The GRECIAN was Foote's morning lounge. In 1843 the premises became the Grecian Chambers, with a bust of Lord Devereux, earl of Essex, over the door.

LLOYD'S, Royal Exchange, celebrated for its priority of shipping intelligence and its marine insurance, originated with Edward Lloyd, who about 1688 kept a coffee house in Tower Street, later in Lombard Street corner of Abchurch Lane. It was a modest place of refreshment for seafarers and merchants. As a matter of convenience, Edward Lloyd prepared "ships' lists" for the guidance of the frequenters of the coffee house. "These lists, which were written by hand, contained," according to Andrew Scott, "an account of vessels which the underwriters who met there were likely to have offered them for insurance." Such was the beginning of two institutions that have since exercised a dominant influence on the sea-carrying trade of the whole world—the Royal Ex-



TOM'S COFFEE HOUSE, 17 GREAT RUSSELL STREET  
Used as a coffee house until 1804 and razed in 1865  
From a water color by T. H. Shepherd



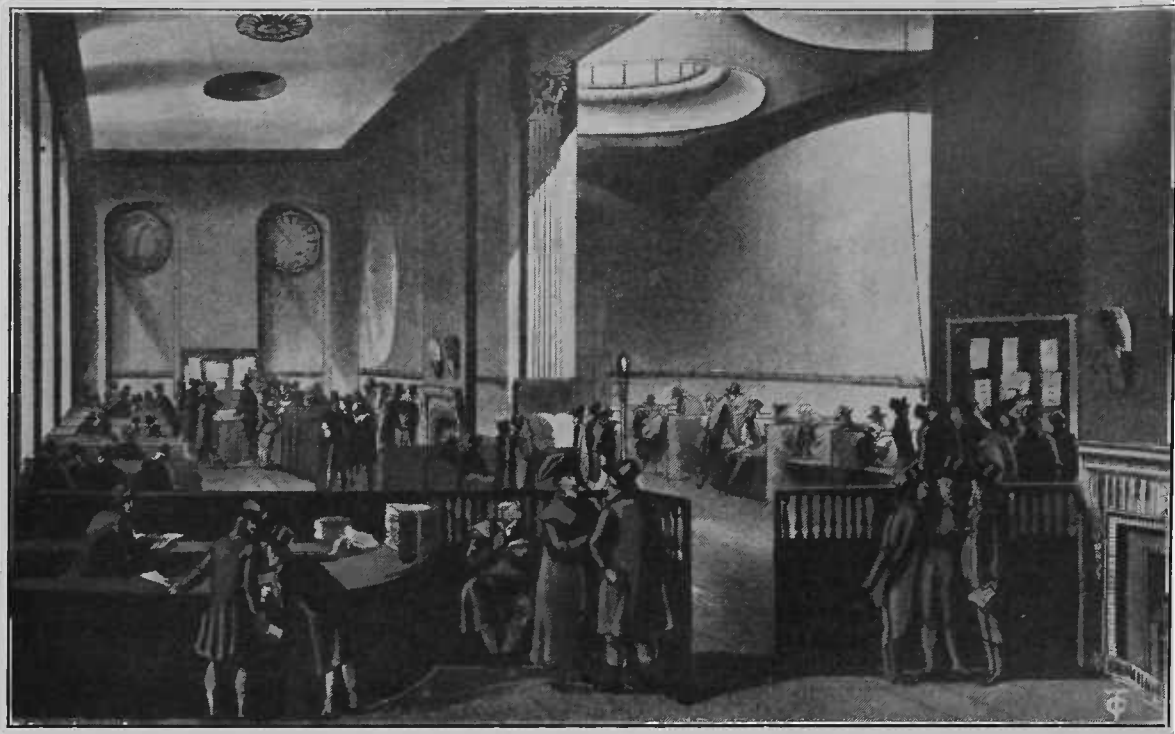
SLAUGHTER'S COFFEE HOUSE, ST. MARTIN'S LANE  
It was taken down in 1843  
From a water color by T. H. Shepherd, 1841

change Lloyd's, the greatest insurance institution in the world, and Lloyd's Register of Shipping. Lloyd's now has 1,400 agents in all parts of the world. It receives as many as 100,000 telegrams a year. It records through its intelligence service the daily movements of 11,000 ships.

In the beginning one of the apartments in the Exchange was fitted up as LLOYD'S coffee room. Edward Lloyd died in 1712. Subsequently the coffee house was in Popé's Head Alley, where it was called NEW LLOYD'S coffee house, but on September 14, 1784, it was removed to the north-west corner of the Royal Exchange, where it remained until the partial destruction of that building by fire.

In rebuilding the Exchange there were provided the Subscribers' or Underwriters' room, the Merchants' room, and the Captains' room. *The City*, second edition, 1848, contains the following description of this most famous rendezvous of eminent merchants, shipowners, underwriters, insurance, stock, and exchange brokers:





LLOYD'S COFFEE HOUSE IN THE ROYAL EXCHANGE, SHOWING THE SUBSCRIPTION ROOM

Here is obtained the earliest news of the arrival and sailing of vessels, losses at sea, captures, recaptures, engagements and other shipping intelligence; and proprietors of ships and freights are insured by the underwriters. The rooms are in the Venetian style with Roman enrichments. At the entrance of the room are exhibited the Shipping Lists, received from Lloyd's agents at home and abroad, and affording particulars of departures or arrivals of vessels, wrecks, salvage, or sale of property saved, etc. To the right and left are "Lloyd's Books," two enormous ledgers. Right hand, ships "spoken with" or arrived at their destined ports; left hand, records of wrecks, fires or severe collisions, written in a fine Roman hand in "double lines." To assist the underwriters in their calculations, at the end of the room is an Anemometer, which registers the state of the wind day and night; attached is a rain gauge.

THE BRITISH, Cockspur Street, "long a house of call for Scotchmen," was fortunate in its landladies. In 1759 it was kept by the sister of Bishop Douglas, so well known for his works against Lauder and Bower, which may explain its Scottish fame. At another period it was kept by Mrs. Anderson, described in Mackenzie's *Life of Home* as "a woman of uncommon talents and the most agreeable conversation."

DON SALTERO'S, 18 Cheyne Walk, Chelsea, was opened by a barber named Salter in 1695. Sir Hans Sloane contributed of

his own collection some of the refuse gimcracks that were to be found in Salter's "museum." Vice-Admiral Munden, who had been long on the coast of Spain, where he had acquired a fondness for Spanish titles, named the keeper of the house Don Saltero, and his coffee house and museum DON SALTERO'S.

SQUIRE'S was in Fulwood's Rents, Holburn, running up to Gray's Inn. It was one of the receiving houses of the *Spectator*. In No. 269 the *Spectator* accepts Sir Roger de Coverley's invitation to "smoke a pipe with him over a dish of coffee at Squire's. As I love the old man, I take delight in complying with everything that is agreeable to him, and accordingly waited on him to the coffee-house, where his venerable figure drew upon us the eyes of the whole room. He had no sooner seated himself at the upper end of the high table, but he called for a clean pipe, a paper of tobacco, a dish of coffee, a wax candle and the *Supplement* (a periodical paper of that time), with such an air of cheerfulness and good humour, that all the boys in the coffee room (who seemed to take pleasure in serving him) were at once employed on his several errands, insomuch that nobody else could come at a dish of tea until the Knight had got all his conveniences about him."

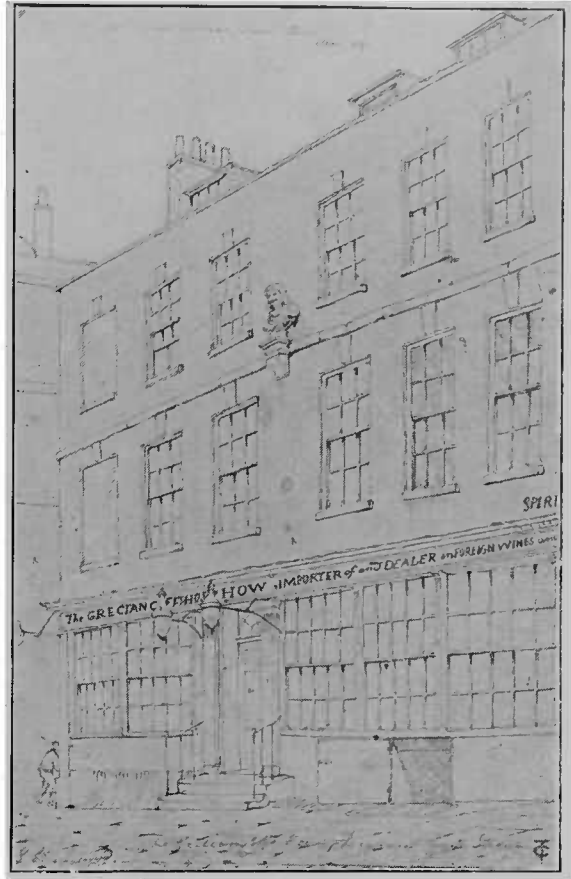
Such was the coffee room in the *Spectator's* day.

The COCOA-TREE was originally a coffee house on the south side of Pall Mall. When there grew up a need for "places of resort of a more elegant and refined character," chocolate houses came into vogue, and the COCOA-TREE was the most famous of these. It was converted into a club in 1746.

WHITE'S chocolate house, established by Francis White about 1693, in St. James's Street, originally open to any one as a coffee house, soon became a private club, composed of "the most fashionable exquisites of the town and court." In its coffee-house days, the entrance was sixpence, as compared with the average penny fee of the other coffee houses. Escott refers to WHITE'S as being "the one specimen of the class to which it belongs, of a place at which, beneath almost the same roof, and always bearing the same name, whether as coffee house or club, the same



INTERIOR OF DICK'S COFFEE HOUSE  
From the frontispiece of "The Coffee House—a dramattick Piece" (see chapter XXXVII)

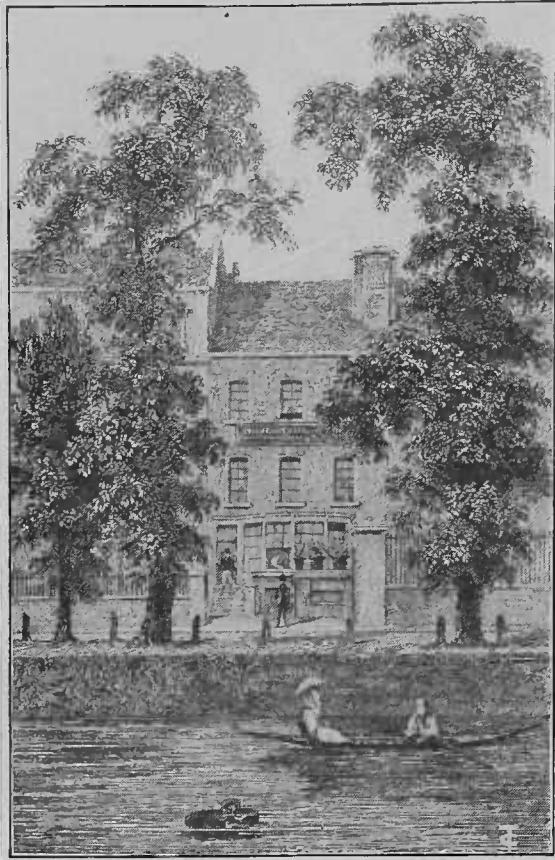


THE GRECIAN COFFEE HOUSE, DEVEREUX COURT  
It was closed in 1843. From a drawing dated 1809

class of persons has congregated during more than two hundred years."

Among hundreds of other coffee houses that flourished during the seventeenth and eighteenth centuries the following more notable ones are deserving of mention:

BAKER'S, 58 'Change Alley, for nearly half a century noted for its chops and steaks broiled in the gridiron; the BALTIC, in Threadneedle Street, the rendezvous of brokers and merchants connected with the Russian trade; the BEDFORD, "under the Piazza, in Covent Garden," crowded every night with men of parts and "signalized for many years as the emporium of wit, the seat of criticism and the standard of taste"; the CHAPTER, in Paternoster Row, frequented by Chatterton and Goldsmith; CHILD'S, in St. Paul's Churchyard, one of the *Spectator's* houses, and much frequented by the clergy and fellows of the Royal Society; DICK'S, in Fleet Street, frequented by Cowper, and the scene of Rousseau's comedietta, entitled *The Coffee*



DON SALTERO'S COFFEE HOUSE, CHEYNE WALK  
From a steel engraving in the British Museum

House; ST. JAMES'S, in St. James's Street, frequented by Swift, Goldsmith, and Garrick; JERUSALEM, in Cowper's Court, Cornhill, frequented by merchants and captains connected with the commerce of China, India, and Australia; JONATHAN'S, in 'Change Alley, described by the *Tatler* as "the general mart of stock jobbers"; the LONDON, in Ludgate Hill, noted for its publishers' sales of stock and copyrights; MAN'S, in Scotland Yard, which took its name from the proprietor, Alexander Man, and was sometimes known as OLD MAN'S, or the ROYAL, to distinguish it from YOUNG MAN'S, LITTLE MAN'S, NEW MAN'S, etc., minor establishments in the neighborhood;<sup>19</sup> NANDO'S, in Fleet Street, the favorite haunt of Lord Thurlow and many professional loungers, attracted by the fame of the punch and the charms of the landlady; NEW ENGLAND AND NORTH AND SOUTH AMERICAN, in Threadneedle Street, having on its subscription list representa-

<sup>19</sup> There were six places, all told, bearing the name "Man's". Alexander Man was coffee maker to William III.

tives of Barings, Rothschilds, and other wealthy establishments; PEELE'S, in Fleet Street, having a portrait of Dr. Johnson said to have been painted by Sir Joshua Reynolds; the PERCY, in Oxford Street, the inspiration for the *Percy Anecdotes*; the PIAZZA, in Covent Garden, where Macklin fitted up a large coffee room, or theater, for oratory, and Fielding and Foote poked fun at him; the RAINBOW, in Fleet Street, the second coffee house opened in London, having its token money; the SMYRNA, in Pall Mall, a "place to talk politics," and frequented by Prior and Swift; TOM KING'S, one of the old night houses of Covent Garden Market, "well known to all gentlemen to whom beds are unknown"; the TURK'S HEAD, 'Change Alley, which also had its tokens; the TURK'S HEAD, in the Strand, which was a favorite supping house for Dr. Johnson and Boswell; and the FOLLY, a coffee house on a houseboat on the Thames, which became notorious during Queen Anne's reign.



THE BRITISH COFFEE HOUSE  
IN COCKSPUR STREET  
From a print published in 1770



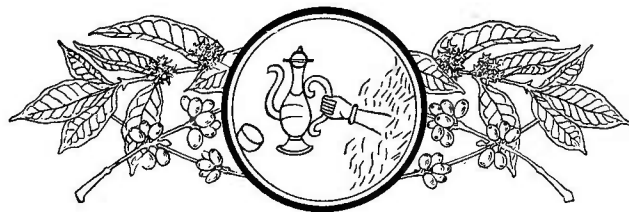
THE FRENCH COFFEE HOUSE IN LONDON, SECOND HALF OF THE EIGHTEENTH CENTURY

From the original water-color drawing by Thomas Rowlandson

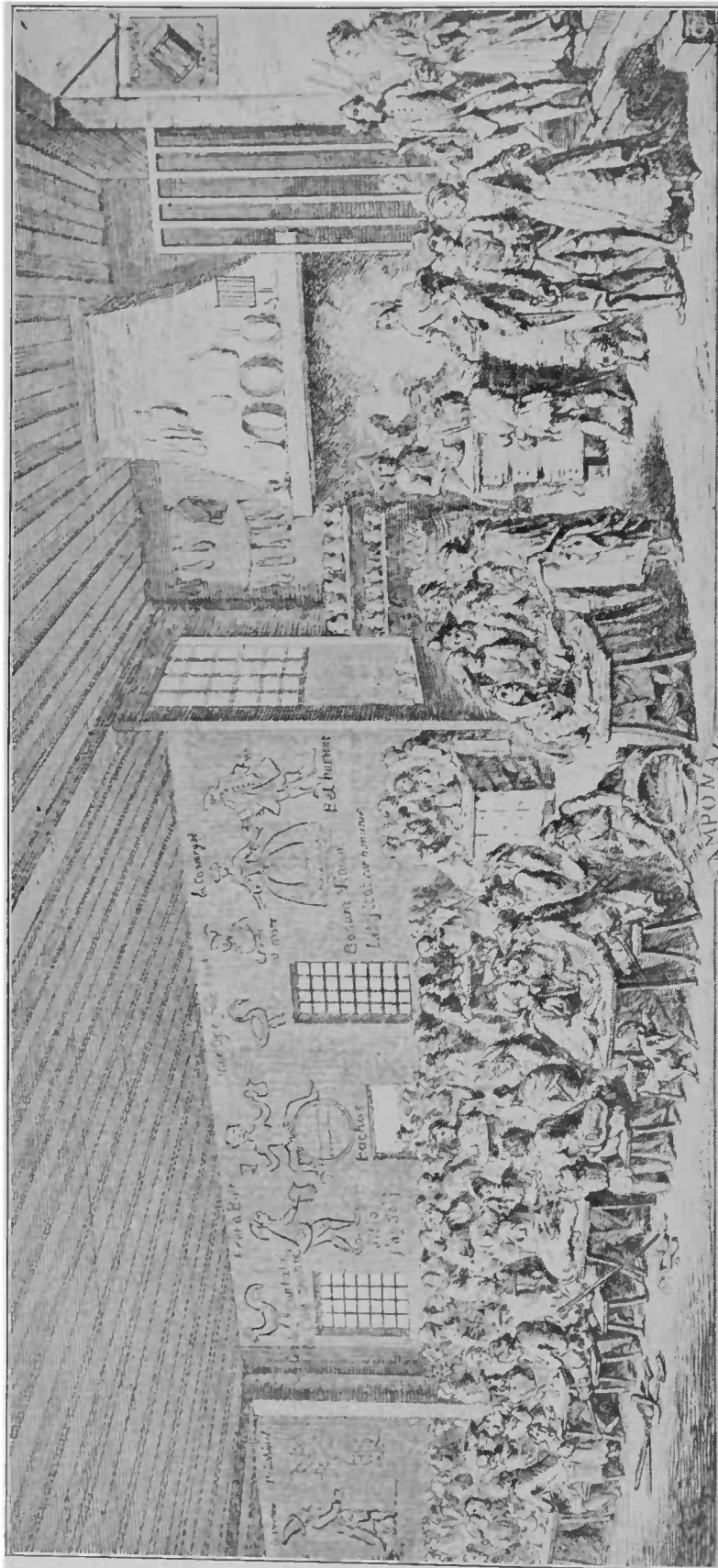
Apropos of the partial revival of the London coffee house in the latter part of the nineteenth century, Edward Forbes Robinson, in his delightful *Early History of Coffee Houses in England*, remarks rather sadly:

Not many of the distinctive features of the coffee house may be recognized; attempts are sometimes made in places bearing this name to imitate the social conditions of tavern life, whilst in others a return is made to the primitive simplicity of the days when coffee first

became known in this country. They have one and all ceased to be centers of literary activity. Some of the old traditions are likely enough to be revived, yet we cannot venture to say whether the coffee house will again in any degree occupy its peculiar social position, mid-way between the open tavern and the private club. To be reasonably select, and yet so far inclusive as to bring together all those who have something in common, and to induce them to lay aside for a while the reserve habitual to our nation—this would be its ideal. The success of the coffee house in realizing such an ideal must always appear remarkable to later and less fortunate Englishmen.







*Au sein de la paix, goûter le plaisir  
 Chacun s'amuse dans un bon loisir  
 On bien des Maquis s'allaient divertir  
 C'était la vieille méthode  
 A Paris en 1789, dans la maison de St. Pierre, N. P. Laroque*



*On voit autour d'un coupe-rose Barbaux  
 Sans hésiter quitter leurs travaux  
 Pourquoy s'est qu'ils vont chez M. de Ramponnaux  
 Fada la Tavernier a la messe  
 Avec Permission de M. de la Couronne, Colonel de Police*

**RAMPONNAUX' ROYAL DRUMMER, ONE OF THE MOST POPULAR OF THE EARLY PARISIAN CAFÉS**  
 Started originally as a tavern, this hostelry added coffee to its cuisine and became famous in the reign of Louis XV  
 The illustration is from an early print used to advertise the "Royal Drummer's" attractions



## CHAPTER X

### HISTORY OF THE EARLY PARISIAN COFFEE HOUSES

THE INTRODUCTION OF COFFEE INTO PARIS BY THÉVENOT IN 1657—HOW SOLIMAN AGA ESTABLISHED THE CUSTOM OF COFFEE DRINKING AT THE COURT OF LOUIS XIV—OPENING THE FIRST COFFEE HOUSES—HOW THE FRENCH ADAPTATION OF THE ORIENTAL COFFEE HOUSE FIRST APPEARED IN THE REAL FRENCH CAFÉ OF FRANÇOIS PROCOPE—THE IMPORTANT PART PLAYED BY THE COFFEE HOUSES IN THE DEVELOPMENT OF FRENCH LITERATURE AND THE STAGE—THEIR ASSOCIATION WITH THE REVOLUTION AND THE FOUNDING OF THE REPUBLIC—QUAINT CUSTOMS AND PATRONS—HISTORIC PARISIAN CAFÉS

IF we are to accept the authority of Jean La Roque, "before the year 1669 coffee had scarcely been seen in Paris, except at M. Thévenot's and at the home of some of his friends. Nor had it been heard of except in the writings of travelers."

As noted in chapter IV, Jean de Thévenot brought coffee into Paris in 1657. One account says that a decoction, supposed to have been coffee, was sold by a Levantine in the Petit Châtelet under the name of *cohove* or *cahoue* during the reign of Louis XIII, but this lacks confirmation. Louis XIV is said to have been served with coffee for the first time in 1664.

Soon after the arrival, in July, 1669, of the Turkish ambassador, Soliman Aga, it became noised about that he had brought with him for his own use, and that of his retinue, great quantities of coffee. He "treated several persons with it, both in the court and the city." At length "many accustomed themselves to it with sugar, and others who found benefit by it could not leave it off."

Within six months all Paris was talking of the sumptuous coffee functions of the ambassador from Mohammed IV to the court of Louis XIV

Isaac D'Israeli best describes them in his *Curiosities of Literature*:

On bended knee, the black slaves of the Ambassador, arrayed in the most gorgeous Oriental costumes, served the choicest Mocha coffee

in tiny cups of egg-shell porcelain, hot, strong and fragrant, poured out in saucers of gold and silver, placed on embroidered silk doylies fringed with gold bullion, to the grand dames, who fluttered their fans with many grimaces, bending their piquant faces—be-rouged, be-powdered and be-patched—over the new and steaming beverage.

It was in 1669 or 1672 that Madame de Sévigné (Marie de Rabutin-Chantal; 1626-96), the celebrated French letter-writer, is said to have made that famous prophecy, "There are two things Frenchmen will never swallow—coffee and Racine's poetry," sometimes abbreviated into, "Racine and coffee will pass." What Madame really said, according to one authority, was that Racine was writing for Champmeslé, the actress, and not for posterity; again, of coffee she said, "*s'en dégoûterait comme, d'un indigne favori* (People will become disgusted with it as with an unworthy favorite).

Larousse says the double judgment was wrongly attributed to Mme. de Sévigné. The celebrated aphorism, like many others, was forged later. Mme. de Sévigné said, "Racine made his comedies for the Champmeslé—not for the ages to come." This was in 1672. Four years later, she said to her daughter, "You have done well to quit coffee. Mlle. de Mere has also given it up."

However it may have been, the amiable letter-writer was destined to live to see Frenchmen yielding at once to the lure of



COFFEE WAS FIRST SOLD AND SERVED PUBLICLY IN  
THE FAIR OF ST.-GERMAIN  
From a Seventeenth-Century Print

coffee and to the poetical artifices of the greatest dramatic craftsman of his day.

While it is recorded that coffee made slow progress with the court of Louis XIV, the next king, Louis XV, to please his mistress, du Barry, gave it a tremendous vogue. It is related that he spent \$15,000 a year for coffee for his daughters.

Meanwhile, in 1672, one Pascal, an Armenian, first sold coffee publicly in Paris. Pascal, who, according to one account, was brought to Paris by Soliman Aga, offered the beverage for sale from a tent, which was also a kind of booth, in the fair of St.-Germain, supplemented by the service of Turkish waiter boys, who peddled it among the crowds from small cups on trays. The fair was held during the first two months of spring, in a large open plot just inside the walls of Paris and near the Latin

Quarter. As Pascal's waiter boys circulated through the crowds on those chilly days the fragrant odor of freshly made coffee brought many ready sales of the steaming beverage; and soon visitors to the fair learned to look for the "little black" cupful of cheer, or *petit noir*, a name that still endures.

When the fair closed, Pascal opened a small coffee shop on the Quai de l'École, near the Pont Neuf; but his frequenters were of a type who preferred the beers and wines of the day, and coffee languished. Pascal continued, however, to send his waiter boys with their large coffee jugs, that were heated by lamps; through the streets of Paris and from door to door. Their cheery cry of "*café! café!*" became a welcome call to many a Parisian, who later missed his *petit noir* when Pascal gave up and moved on to London, where coffee drinking was then in high favor.

Lacking favor at court, coffee's progress was slow. The French smart set clung to its light wines and beers. In 1672, Maliban, another Armenian, opened a coffee house in the rue Bussy, next to the Metz tennis court near St.-Germain's abbey. He supplied tobacco also to his customers. Later he went to Holland, leaving his servant and partner, Gregory, a Persian, in charge.



STREET COFFEE VENDER OF PARIS—PERIOD, 1672  
TO 1689—TWO SOUS PER DISH, SUGAR INCLUDED

Gregory moved to the rue Mazarine, to be near the Comédie Française. He was succeeded in the business by Makara, another Persian, who later returned to Ispahan, leaving the coffee house to one Le Gantois, of Liège.

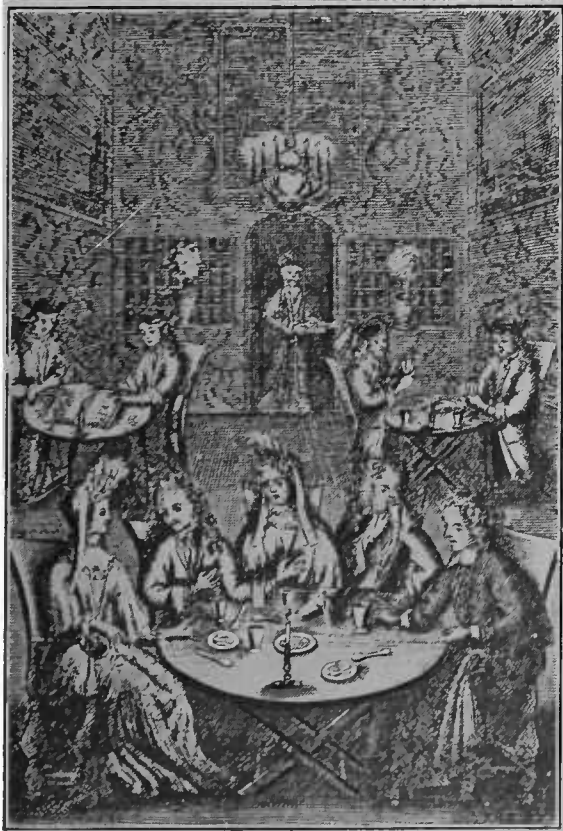
About this period there was a cripple boy from Candia, known as le Candiote, who began to cry "coffee!" in the streets of Paris. He carried with him a coffee pot of generous size, a chafing-dish, cups, and all other implements necessary to his trade. He sold his coffee from door to door at two sous per dish, sugar included.

A Levantine named Joseph also sold coffee in the streets, and later had several coffee shops of his own. Stephen, from Aleppo, next opened a coffee house on Pont au Change, moving, when his business prospered, to more pretentious quarters in the rue St.-André, facing St.-Michael's bridge.

All these, and others, were essentially the Oriental style of coffee house of the lower order, and they appealed principally to the



A CORNER OF THE HISTORIC CAFÉ DE PROCOPE  
SHOWING VOLTAIRE AND DIDEROT IN DEBATE  
From a rare water color



MANY OF THE EARLY PARISIAN COFFEE HOUSES  
FOLLOWED PASCAL'S LEAD AND AFFECTED  
ARMENIAN DECORATIONS  
From a Seventeenth-Century Print

poorer classes and to foreigners. "Gentlemen and people of fashion" did not care to be seen in this type of public house. But when the French merchants began to set up, first at St.-Germain's fair, "spacious apartments in an elegant manner, ornamented with tapestries, large mirrors, pictures, marble tables, branches for candles, magnificent lustres, and serving coffee, tea, chocolate, and other refreshments," they were soon crowded with people of fashion and men of letters.

In this way coffee drinking in public acquired a badge of respectability. Presently there were some three hundred coffee houses in Paris. The principal coffee men, in addition to plying their trade in the city, maintained coffee rooms in St.-Germain's and St.-Laurence's fairs. These were frequented by women as well as men.

*The Progenitor of the Real Parisian Café*

It was not until 1689, that there appeared in Paris a real French adaptation of the Oriental coffee house. This was the Café



**THE CAFÉ DE PROCOPE IN 1743**

From an engraving by Bosredon

de Procope, opened by François Procope (Procopio Cultelli, or Cotelli) who came from Florence or Palermo. Procope was a *limonadier* (lemonade vender) who had a royal license to sell spices, ices, barley water, lemonade, and other such refreshments. He early added coffee to the list, and attracted a large and distinguished patronage.

Procope, a keen-witted merchant, made his appeal to a higher class of patrons than did Pascal and those who first followed him. He established his café directly opposite the newly opened Comédie Française, in the street then known as the rue des Fossés-St.-Germain, but now the rue de l'Ancienne Comédie. A writer of the period has left this description of the place: "The Café de Procope . . . was also called the Antre [cavern] de Procope, because it was very dark even in full day, and ill-lighted in the evenings; and because you often saw there a set of lank, sallow poets, who had somewhat the air of apparitions."

Because of its location, the Café de Procope became the gathering place of many noted French actors, authors, dramatists, and musicians of the eighteenth century. It was a veritable literary salon. Voltaire was a constant patron; and until the close of the historic café, after an existence of more than two centuries, his marble table and chair were among the precious relics of the coffee house. His favorite drink is said to have been a mixture of coffee and chocolate. Rousseau, author and philosopher; Beaumarchais, dramatist and financier; Diderot, the encyclopedist; Ste. Foix, the abbé of Voisenon; de Belloy, author of the *Siege of Callais*; Lemierre, author of *Artaxerce*; Crébillon; Piron; La Chaussée; Fontenelle; Condorcet; and a host of lesser lights in the French arts, were habitués of François Procope's modest coffee saloon near the Comédie Française.

Naturally, the name of Benjamin Franklin, recognized in Europe as one of the world's foremost thinkers in the days of the American Revolution, was often spoken over the coffee cups of Café de Procope; and when the distinguished American died in 1790, this French coffee house went into deep mourning "for the great friend of republicanism." The walls, inside and out, were swathed in black bunting, and the statesmanship and scientific attainments of Franklin were acclaimed by all frequenters.

The Café de Procope looms large in the

annals of the French Revolution. During the turbulent days of 1789 one could find at the tables, drinking coffee or stronger beverages, and engaged in debate over the burning questions of the hour, such characters as Marat, Robespierre, Danton, Hébert, and Desmoulins. Napoleon Bonaparte, then a poor artillery officer seeking a commission, was also there. He busied himself largely in playing chess, a favorite recreation of the early Parisian coffee-house patrons. It is related that François Procope once compelled young Bonaparte to leave his hat for security while he sought money to pay his coffee score.

After the Revolution, the Café de Procope lost its literary prestige and sank to the level of an ordinary restaurant. During the last half of the nineteenth century, Paul Verlaine, bohemian, poet, and leader of the symbolists, made the Café de Procope his haunt; and for a time it regained some of its lost popularity. The Restaurant Procope still survives at 13 rue de l'Ancienne Comédie.

History records that, with the opening of the Café de Procope, coffee became firmly established in Paris. In the reign of Louis XV there were 600 cafés in Paris. At the close of the eighteenth century there were more than 800. By 1843 the number had increased to more than 3,000.

#### *The Development of the Cafés*

Coffee's vogue spread rapidly, and many cabarés and famous eating houses began to add it to their menus. Among these was the Tour d'Argent (silver tower), which had been opened on the Quai de la Tournelle in 1582, and speedily became Paris's most fashionable restaurant. It still is one of the chief attractions for the epicure, retaining the reputation for its cooking that drew a host of world leaders, from Napoleon to Edward VII, to its quaint interior.

Another tavern that took up coffee after Procope, was the Royal Drummer, which Jean Ramponaux established at the Courtille des Porcherons and which followed Magny's. His hostelry rightly belongs to the tavern class, although coffee had a prominent place on its menu. It became notorious for excesses and low-class vices during the reign of Louis XV, who was a frequent visitor. Low and high were to be found in Ramponaux's cellar, particularly





THE CAFÉ FOY IN THE PALAIS ROYAL, 1789

From an engraving by Bosredon



THE CASHIER'S COUNTER IN A PARIS COFFEE HOUSE OF 1782

From a drawing by Rétif de la Bretonne

when some especially wild revelry was in prospect. Marie Antoinette once declared she had her most enjoyable time at a wild *farandole* in the Royal Drummer. Ramponaux was taken to its heart by fashionable Paris; and his name was used as a trade mark on furniture, clothes, and foods.

The popularity of Ramponaux's Royal Drummer is attested by an inscription on an early print showing the interior of the café. Translated, it reads:

The pleasures of ease untroubled to taste,  
The leisure of home to enjoy without haste,  
Perhaps a few hours at Magny's to waste,  
Ah, that was the old-fashioned way!  
Today all our laborers, everyone knows,  
Go running away ere the working hours close,  
And why? They must be at Monsieur Ramponaux's!  
Behold, the new style of café!

When coffee houses began to crop up rapidly in Paris, the majority centered in the Palais Royal, "that garden spot of beauty, enclosed on three sides by three tiers of galleries," which Richelieu had erected in 1636, under the name of Palais

Cardinal, in the reign of Louis XIII. It became known as the Palais Royal in 1643; and soon after the opening of the Café de Procope, it began to blossom out with many attractive coffee stalls, or rooms, sprinkled among the other shops that occupied the galleries overlooking the gardens.

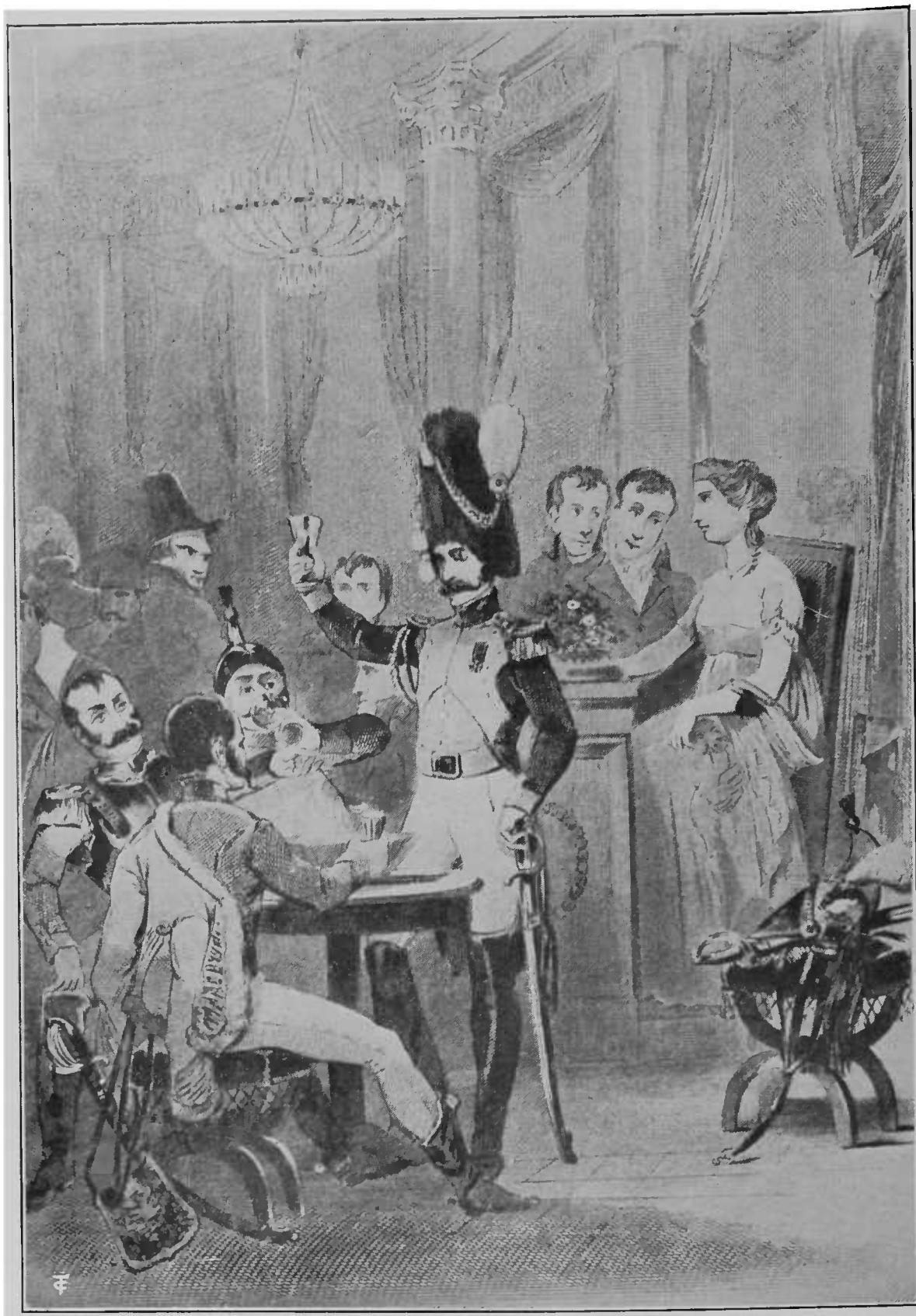
#### *Life in the Early Coffee Houses*

Diderot tells in 1760, in his *Rameau's Nephew*, of the life and frequenters of one of the Palais Royal coffee houses, the Café de la Régence:

In all weathers, wet or fine, it is my practice to go toward five o'clock in the evening to take a turn in the Palais Royal. . . . If the weather is too cold or too wet I take shelter in the Regency coffee house. There I amuse myself by looking on while they play chess. Nowhere in the world do they play chess as skillfully as in Paris and nowhere in Paris as they do at this coffee house; 'tis here you see Légal the profound, Philidor the subtle, Mayot the solid; here you see the most astounding moves, and listen to the sorriest talk, for if a man be at once a wit and a great chess player, like Légal, he may also be a great chess player and a sad simpleton, like Joubert and Mayot.

The beginnings of the Regency coffee house are associated with the legend that Lefèvre, a Parisian, began peddling coffee in the streets of Paris about the time Procope opened his café in 1689. The story has it that Lefèvre later opened a café near the Palais Royal, selling it in 1718 to one Leclerc, who named it the Café de la Régence, in honor of the regent of Orleans, a name that still endures on a broad sign over its doors. The nobility had their rendezvous there after having paid their court to the regent.

To name the patrons of the Café de la Régence in its long career would be to outline a history of French literature for more than two centuries. There was Philidor the "greatest theoretician of the eighteenth century, better known for his chess than his music"; Robespierre, of the Revolution, who once played chess with a girl—disguised as a boy—for the life of her lover; Napoleon, who was then noted more for his chess than his empire-building propensities; and Gambetta, whose loud voice, generally raised in debate, disturbed one chess player so much that he protested because he could not follow his game. Voltaire, Alfred de Musset, Victor Hugo, Théophile Gautier, J. J. Rousseau, the Duke of Richelieu, Marshall Saxe, Buffon,



THE CAFÉ DES MILLE COLONNES IN 1811

From an engraving by Bosredon

Rivarol, Fontenelle, Franklin, and Henry Murger are names still associated with memories of this historic café. Marmontel and Philidor played there at their favorite game of chess. Diderot tells in his *Memoirs* that his wife gave him every day nine sous to get his coffee there. It was in this establishment that he worked on his *Encyclopedie*.

Chess is still in favor at the Régence, although the players are not, as were the earlier patrons, obliged to pay by the hour for their tables with extra charges for candles placed by the chess-boards. The present Café de la Régence is in the rue St.-Honoré, but retains in large measure its aspect of olden days.

Michelet, the historian, has given us a rhapsodic pen picture of the Parisian cafés under the regency:

Paris became one vast café. Conversation in France was at its zenith. There were less eloquence and rhetoric than in '89. With the exception of Rousseau, there was no orator to cite. The intangible flow of wit was as spontaneous as possible. For this sparkling outburst there is no doubt that honor should be ascribed in part to the auspicious revolution of the times, to the great event which created new customs, and even modified human temperament—the advent of coffee.

Its effect was immeasurable, not being weakened and neutralized as it is today by the brutalizing influence of tobacco. They took snuff, but did not smoke. The cabarét was dethroned, the ignoble cabarét, where, during the reign of Louis XIV, the youth of the city rioted amid wine-casks in the company of light women. The night was less thronged with chariots. Fewer lords found a resting place in the gutter. The elegant shop, where conversation flowed, a salon rather than a shop, changed and ennobled its customs. The reign of coffee is that of temperance. Coffee, the beverage of sobriety, a powerful mental stimulant, which, unlike spirituous liquors, increases clearness and lucidity; coffee, which suppresses the vague, heavy fantasies of the imagination, which from the perception of reality brings forth the sparkle and sunlight of truth; coffee anti-erotic.

The three ages of coffee are those of modern thought; they mark the serious moments of the brilliant epoch of the soul.

Arabian coffee is the pioneer, even before 1700. The beautiful ladies that you see in the fashionable rooms of Bonnard, sipping from their tiny cups—they are enjoying the aroma of the finest coffee of Arabia. And of what are they chatting? Of the seraglio, of Chardin, of the Sultana's coiffure, of the *Thousand and One Nights* (1704). They compare the ennui of Versailles with the paradise of the Orient.

Very soon, in 1710-1720, commences the reign of Indian coffee, abundant, popular, comparatively cheap. Bourbon, our Indian island, where coffee was transplanted, suddenly realizes unheard-of happiness. This coffee of volcanic

lands acts as an explosive on the Regency and the new spirit of things. This sudden cheer, this laughter of the old world, these overwhelming flashes of wit, of which the sparkling verse of Voltaire, the *Persian Letters*, give us a faint idea! Even the most brilliant books have not succeeded in catching on the wing this airy chatter, which comes, goes, flies elusively. This is that spirit of ethereal nature which, in the *Thousand and One Nights*, the enchanter confined in his bottle. But what phial would have withstood that pressure?

The lava of Bourbon, like the Arabian sand, was unequal to the demand. The Regent recognized this and had coffee transported to the fertile soil of our Antilles. The strong coffee of Santo Domingo, full, coarse, nourishing as well as stimulating, sustained the adult population of that period, the strong age of the encyclopedia. It was drunk by Buffon, Diderot, Rousseau, added its glow to glowing souls, its light to the penetrating vision of the prophets gathered in the cave of Procope, who saw at the bottom of the black beverage the future rays of '89. Danton, the terrible Danton, took several cups of coffee before mounting the tribune. "The horse must have its oats," he said.

The vogue of coffee popularized the use of sugar, which was then bought by the ounce at the apothecary's shop. Dufour says that in Paris they used to put so much sugar in the coffee that "it was nothing but a syrup of blackened water." The ladies were wont to have their carriages stop in front of the Paris cafés and to have their coffee served to them by the porter on saucers of silver.

Every year saw new cafés opened. When they became so numerous, and competition grew so keen, it was necessary to invent new attractions for customers. Then was born the *café chantant*, where songs, monologues, dances, little plays and farces—not always in the best taste—were provided to amuse the frequenters. Many of these *cafés chantants* were in the open air along the Champs-Élysées. In bad weather, Paris provided the pleasure-seeker with the Eldorado, Alcazar d'Hiver, Scala, Gaieté, Concert du XIX<sup>me</sup> Siècle, Folies Bobino, Rambuteau, Concert Européen, and countless other meeting places where one could be served with a cup of coffee.

As in London, certain cafés were noted for particular followings, like the military, students, artists, merchants. The politicians had their favorite resorts. Says Salvandy:

These were senates in miniature here mighty political questions were discussed; here peace and war were decided upon; here generals were brought to the bar of justice . . . distinguished orators were victoriously refuted, ministers





THE CAFÉ DE PARIS IN 1843

From an engraving by Bosredon



heckled upon their ignorance, their incapacity their perfidy, their corruption. The café is in reality a French institution; in them we find all these agitations and movements of men, the like of which is unknown in the English tavern. No government can go against the sentiment of the cafés. The Revolution took place because they were for the Revolution. Napoleon reigned because they were for glory. The Restoration was shattered, because they understood the Charter in a different manner.<sup>1</sup>

In 1700 appeared the *Portefeuille Galant*, containing conversations of the cafés.

#### *The Cafés in the French Revolution*

The Palais Royal coffee houses were centers of activity in the days preceding and following the Revolution. A picture of them in the July days of 1789 has been left by Arthur Young, who was visiting Paris at that time:

The coffee houses present yet more singular and astounding spectacles; they are not only crowded within, but other expectant crowds are at the doors and windows, listening *a gorge déployée* to certain orators who from chairs or tables harangue each his little audience; the eagerness with which they are heard, and the thunder of applause they receive for every sentiment of more than common hardness or violence against the government, cannot easily be imagined.

The Palais Royal teemed with excited Frenchmen on the fateful Sunday of July 12, 1789. The moment was a tense one, when, coming out of the Café Foy, Camille Desmoulins, a youthful journalist, mounted a table and began the harangue that precipitated the first overt act of the French Revolution. Blazing with a white hot frenzy, he so played upon the passions of the mob that at the conclusion of his speech he and his followers "marched away from the Café on their errand of Revolution." The Bastille fell two days later.

As if abashed by its reputation as the starting point of the mob spirit of the Revolution, Café Foy became in after years a sedate gathering-place of artists and literati. Up to its close it was distinguished among other famous Parisian cafés for its exclusiveness and strictly enforced rule of "no smoking."

Even from the first the Parisian cafés catered to all classes of society; and, unlike the London coffee houses, they retained this distinctive characteristic. A number of them early added other liquid and substan-

tial refreshments, many becoming out-and-out restaurants.

#### *Coffee-House Customs and Patrons*

Coffee's effect on Parisians is thus described by a writer of the latter part of the eighteenth century:

I think I may safely assert that it is to the establishment of so many cafés in Paris that is due the urbanity and mildness discernible upon most faces. Before they existed, nearly everybody passed his time at the cabarét, where even business matters were discussed. Since their establishment, people assemble to hear what is going on, drinking and playing only in moderation, and the consequence is that they are more civil and polite, at least in appearance.

Montesquieu's satirical pen pictured in his *Persian Letters* the earliest cafés as follows:

In some of these houses they talk news; in others, they play draughts. There is one where they prepare the coffee in such a manner that it inspires the drinkers of it with wit; at least, of all those who frequent it, there is not one person in four who does not think he has more wit after he has entered that house. But what offends me in these wits is that they do not make themselves useful to their country.

Montesquieu encountered a geometrician outside a coffee house on the Pont Neuf, and accompanied him inside. He describes the incident in this manner:

I observe that our geometrician was received there with the utmost officiousness, and that the coffee house boys paid him much more respect than two musqueteers who were in a corner of the room. As for him, he seemed as if he thought himself in an agreeable place; for he unwrinkled his brows a little and laughed, as if he had not the least tincture of geometrician in him. . . . He was offended at every start of wit, as a tender eye is by too strong a light. . . . At last I saw an old man enter, pale and thin, whom I knew to be a coffee house politician before he sat down; he was not one of those who are never to be intimidated by disasters, but always prophesy of victories and success; he was one of those timorous wretches who are always boding ill.

Café Momus and Café Rotonde figure conspicuously in the record of French bohemianism. The Momus stood near the right bank of the River Seine in rue des Prêtres St.-Germaine, and was known as the home of the bohemians. The Rotonde stood on the left bank at the corner of the rue de l'Ecole de Médecine and the rue Hautefeuille.

Alexandre Schanne, has given us a glimpse of bohemian life in the early cafés. He lays his scene in the Café Rotonde, and tells how a number of poor students were

<sup>1</sup>Salvandy, Narcisse-Achille. *Influence des Cafés sur les Moeurs Politiques.*

wont to make one cup of coffee last the coterie a full evening by using it to flavor and to color the one glass of water shared in common. He says:

Every evening, the first comer at the waiter's inquiry, "What will you take, sir?" never failed to reply, "Nothing just at present, I am waiting for a friend." The friend arrived, to be assailed by the brutal question, "Have you any money?" He would make a despairing gesture in the negative, and then add, loud enough to be heard by the *dame du comptoir*, "By Jove, no; only fancy, I left my purse on my console-table, with gilt feet, in the purest Louis XV style. Ah! what a thing it is to be forgetful." He would sit down, and the waiter would wipe the table as if he had something to do. A third would come, who was sometimes able to reply, "Yes, I have ten sous." "Good!" we would reply; "order a cup of coffee, a glass and a water bottle; pay and give two sous to the waiter to secure his silence." This would be done. Others would come and take their places beside us, repeating to the waiter the same chorus, "We are with this gentleman." Frequently we would be eight or nine sitting at the same table, and only one customer. Whilst smoking and reading the papers we would, however, pass the glass and bottle. When the water began to run short, as on a ship in distress, one of us would have the impudence to call out, "Waiter, some water!" The master of the establishment, who understood our situation, had no doubt given orders for us to be left alone, and made his fortune without our help. He was a good fellow and an intelligent one, having subscribed to all the scientific journals of Europe, which brought him the custom of foreign students.

Another café perpetuating the best traditions of the Latin Quarter was the Vachette, which survived until the death of Jean Moréas in 1911. The Vachette is usually cited by antiquarians as a model of circumspection as compared with the scores of cafés in the Quarter that were given up to debaucheries. One writer puts it: "The Vachette traditions leaned more to scholarship than sensuality."

In the late seventeenth and early eighteenth centuries the Parisian café was truly a coffee house; but as many of the patrons began to while away most of their waking hours in them, the proprietors added other beverages and food to hold their patronage. Consequently, we find listed among the cafés of Paris some houses that are more accurately described as restaurants, although they may have started their careers as coffee houses.

#### *Historic Parisian Cafés*

Some of the historic cafés are still thriving in their original locations, although the

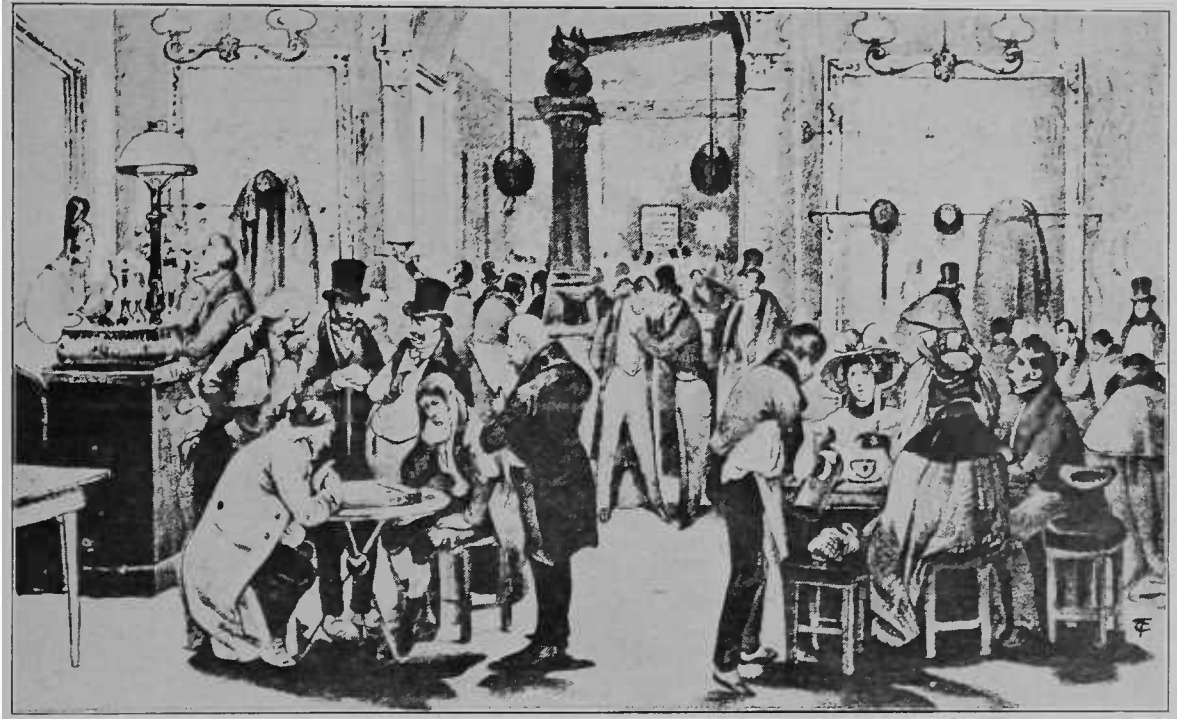
majority have now passed into oblivion. Glimpses of the more famous houses are to be found in the novels, poetry, and essays written by the French literati who patronized them. These first-hand accounts give insights that are sometimes stirring, often amusing, and frequently revolting—such as the assassination of St.-Fargeau in Février's low-vaulted cellar café in the Palais Royal.

There is Magny's, originally the haunt of such literary men as Gautier, Taine, Saint-Victor, Turganev, de Goncourt, Soulie, Renan, Edmond. In recent years the old Magny's was razed, and on its site was built the modern restaurant of the same name, but in a style that has no resemblance to its predecessor. Even the name of the street has been changed, from rue Contrescarpe to the rue Mazet.

Méot's, the Véry, Beauvilliers', Massé's, the Café Chartres, the Troi Frères Provençaux, and the du Grand Commun, all situated in the Palais Royal, are cafés that figured conspicuously in the French Revolution, and are closely identified with the French stage and literature. Méot's and Massé's were the trysting places of the Royalists in the days preceding the outbreak, but welcomed the Revolutionists after they came in power. The Chartres was notorious as the gathering place of young aristocrats who escaped the guillotine, and, thus made bold, often called their like from adjoining cafés to partake in some of their plans for restoration of the empire. The Trois Frères Provençaux, well known for its excellent and costly dinners, is mentioned by Balzac, Lord Lytton, and Alfred de Musset in some of their novels. The Café du Grand Commun appears in Rousseau's *Confessions* in connection with the play *Devin du Village*.

Among the most famous of the cafés on the Rue St. Honoré were Venua's, patronized by Robespierre and his companions of the Revolution, and perhaps the scene of the inhuman murder of Berthier and its revolting aftermath; the Mapinot, which has gone down in café history as the scene of the banquet to Archibald Alison, the 22-year-old historian; and Voisin's café, around which still cling traditions of such literary lights as Zola, Alphonse Daudet, and Jules de Goncourt.

Perhaps the boulevard des Italiens had, and still has, more fashionable cafés than any other section of the French capital.



INTERIOR OF A TYPICAL PARISIAN CAFÉ OF THE EARLY NINETEENTH CENTURY

The Tortoni, opened in the early days of the Empire by Velloni, an Italian lemonade vender, was the most popular of the boulevard cafés, and was generally thronged with fashionables from all parts of Europe. Here Louis Blanc, historian of the Revolution, spent many hours in the early days of his fame. Talleyrand; Rossini, the musician; Alfred Stevens and Edouard Manet, artists, are some of the names still linked with the traditions of the Tortoni. Farther down the boulevard were the Café Riche, Maison Dorée, Café Anglais, and the Café de Paris. The Riche and the Dorée, standing side by side, were both high-priced and noted for their revelries. The Anglais, which came into existence after the snuffing out of the Empire, was also distinguished for its high prices, but in return gave an excellent dinner and fine wines. It is told that even during the siege of Paris the Anglais offered its patrons "such luxuries as ass, mule, peas, fried potatoes, and champagne."

Probably the Café de Paris, which came into existence in 1822, in the former home of the Russian Prince Demidoff, was the most richly equipped and elegantly conducted of any café in Paris in the nineteenth century. Alfred de Musset, a fre-

quenter, said, "you could not open its doors for less than 15 francs."

The Café Littéraire, opened on boulevard Bonne Nouvelle late in the nineteenth century, made a direct appeal to literary men for patronage, printing this footnote on its menu: "Every customer spending a franc in this establishment is entitled to one volume of any work to be selected from our vast collection."

The names of Parisian cafés once more or less famous are legion. Some of them are:

The Café Laurent, which Rousseau was forced to leave after writing an especially bitter satire; the English café, in which eccentric Lord Wharton made merry with the Whig habitués; the Dutch café, the haunt of Jacobites; Terre's, in the rue Neuve des Petits Champs, which Thackeray described in *The Ballad of Bouillabaisse*; Maire's, in the boulevard St.-Denis, which dates back beyond 1850; the Café Madrid, in the boulevard Montmartre, of which Carjat, the Spanish lyric poet, was an attraction; the Café de la Paix, in the boulevard des Capucines, the resort of Second Empire Imperialists and their spies; the Café Durand, in the place de la Madeleine, which started on a plane with the high-priced Riche, and ended its career early in the twentieth century; the Rocher

de Cancale, memorable for its feasts and high-living patrons from all over Europe; the Café Guerbois, near the rue de St. Petersbourg, where Manet, the impressionist, after many vicissitudes, won fame

for his paintings and held court for many years; the Chat Noir, on the rue Victor Massé at Montmartre, a blend of café and concert hall, which has since been imitated widely, both in name and feature.



## CHAPTER XI

### INTRODUCTION OF COFFEE INTO NORTH AMERICA

CAPTAIN JOHN SMITH, FOUNDER OF THE COLONY OF VIRGINIA, IS THE FIRST TO BRING TO NORTH AMERICA A KNOWLEDGE OF COFFEE—THE COFFEE GRINDER OF THE MAYFLOWER—COFFEE DRINKING IN 1668—WILLIAM PENN'S COFFEE PURCHASE IN 1683—COFFEE IN COLONIAL NEW ENGLAND—THE PSYCHOLOGY OF THE BOSTON TEA PARTY, AND WHY THE UNITED STATES BECAME A NATION OF COFFEE DRINKERS INSTEAD OF TEA DRINKERS, LIKE ENGLAND—THE FIRST COFFEE LICENSE—THE FIRST COFFEE HOUSE IN NEW ENGLAND—SOME NOTABLE COFFEE HOUSES OF OLD BOSTON

UNDOUBTEDLY the first to bring a knowledge of coffee to North America was Captain John Smith, who founded the Colony of Virginia at Jamestown in 1607. Captain Smith became familiar with coffee in his travels in Turkey.

Although the Dutch also had early knowledge of coffee, it does not appear that the Dutch West India Company brought any of it to the first permanent settlement on Manhattan Island, in 1624. Nor is there any record of coffee in the cargo of the *Mayflower*, in 1620, although it included a wooden mortar and pestle, later used to make "coffee powder."

#### *Coffee in New Amsterdam*

In the period when New York was New Amsterdam, and under Dutch occupancy, 1624-64, it is possible that coffee may have been imported from Holland, where it was being sold on the Amsterdam market as early as 1640, and where regular supplies of the green bean were being received from Mocha in 1663; but positive proof is lacking. The Dutch appear to have brought tea across the Atlantic from Holland before coffee. The English may have introduced the coffee drink into the New York colony between 1664 and 1673. The earliest reference to coffee in America is in 1668,<sup>1</sup> at

<sup>1</sup> Singleton, Esther. *Dutch New York*. New York, 1909. (p. 132.)

which time a beverage made from the roasted beans, and flavored with sugar or honey and cinnamon, was being drunk in New York.

Coffee first appears in the official records of the New England colony in 1670. In 1683, the year following William Penn's settlement on the Delaware, we find him buying supplies of coffee in the New York market and paying for them at the rate of eighteen shillings and nine pence per pound.<sup>2</sup>

#### *Coffee Houses Established*

Coffee houses patterned after the English and Continental prototypes were soon established in all the colonies. Those in New York and Philadelphia are described in separate chapters. The Boston houses are described at the end of this chapter.

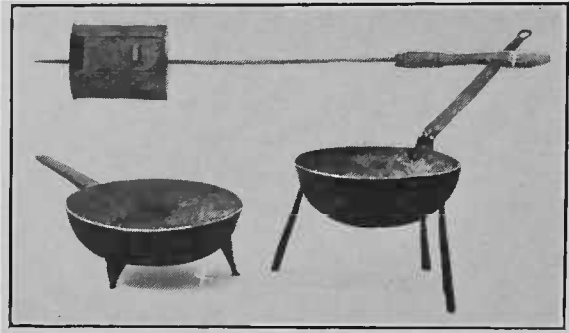
Norfolk, Chicago, St. Louis, and New Orleans also had them. Conrad Leonhard's coffee house at 320 Market Street, St. Louis, was famed for its coffee and coffee cake, from 1844 to 1905, when it became a bakery and lunch room, removing in 1919 to Eighth and Pine Streets.

In the pioneer days of the great West, coffee and tea were hard to get; and, instead of them, teas were often made from garden herbs, spicewood, sassafras-roots,

<sup>2</sup> Bishop, J. Leander. *A History of American Manufactures, 1608 to 1860*. New York, 1864. (Vol. 1: p. 259.)



and other shrubs, taken from the thickets.<sup>3</sup> In 1839, in the city of Chicago, one of the minor taverns was known as the Lake Street coffee house. It was situated at the corner of Lake and Wells Streets. A number of hotels, which in the English sense might more appropriately be called inns, met a demand for modest accommodation.<sup>4</sup> Two coffee houses were listed in the Chicago



TYPES OF COLONIAL COFFEE ROASTERS

The cylinder at the top of the picture was revolved by hand in the fireplace; the skillets were set in the smouldering ashes.

directories for 1843 and 1845, the Washington coffee house, 83 Lake Street; and the Exchange coffee house, Clarke Street between La Salle and South Water Streets.

The oldtime coffee houses of New Orleans were situated within the original area of the city, the section bounded by the river, Canal Street, Esplanade Avenue, and Rampart Street. In the early days most of the big business of the city was transacted in the coffee houses. The *brûleau*, coffee with orange juice, orange peel, and sugar, with cognac burned and mixed in it, originated in the New Orleans coffee house, and led to its gradual evolution into the saloon.

#### *How the United States Became a Nation of Coffee Drinkers*

Coffee, tea, and chocolate were introduced into North America almost simultaneously in the latter part of the seventeenth century. In the first half of the eighteenth century, tea had made such progress in England, thanks to the propaganda of the British East India Company, that, being moved to extend its use in the colonies, the directors turned their eyes in the direction of North America. Here, however, King George spoiled their well-laid plans by his

<sup>3</sup> Patterson, Robert W. *Early Society in Southern Illinois*. Chicago, 1881.

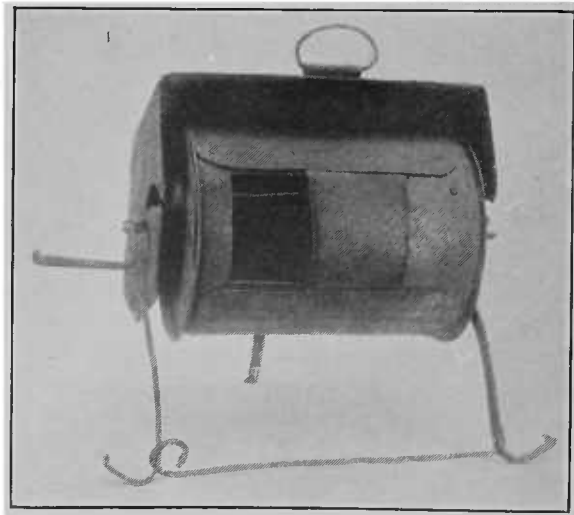
<sup>4</sup> Andreas, A. T. *History of Chicago*. Chicago, 1884.

unfortunate stamp act of 1765, which caused the colonists to raise the cry of "no taxation without representation."

Although the act was repealed in 1766, the right to tax was asserted, and in 1767 was again used, duties being laid on paints, oils, lead, glass, and tea. Once more the colonists resisted; and, by refusing to import any goods of English make, so distressed the English manufacturers that Parliament repealed every tax save that on tea. Despite the growing fondness for the beverage in America, the colonists preferred to get their tea elsewhere to sacrificing their principles and buying it in England. A brisk trade in smuggling tea from Holland followed.

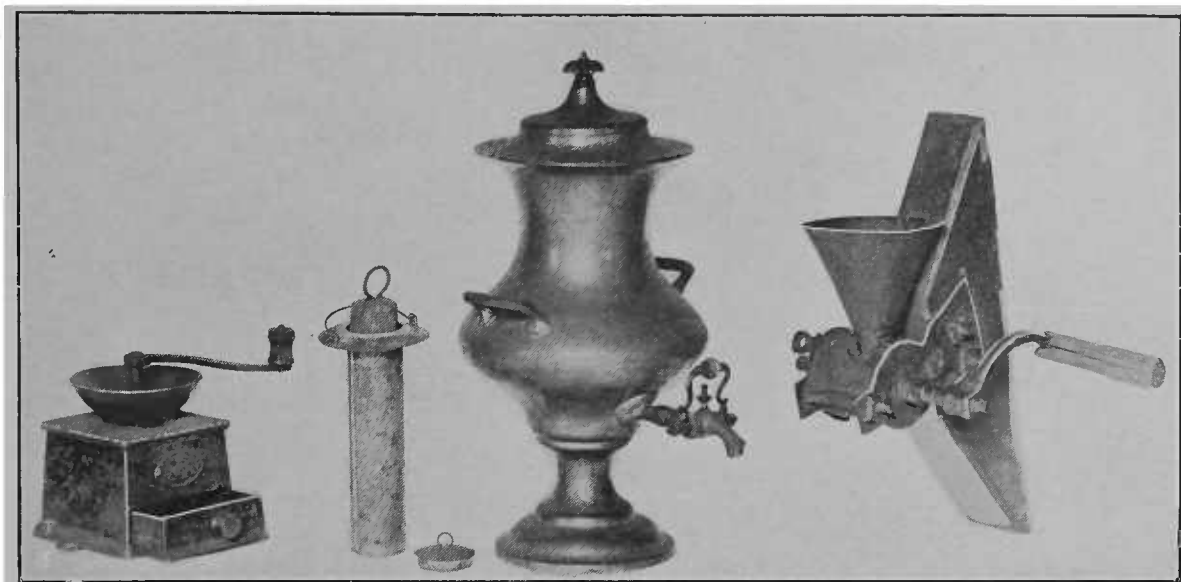
In a panic at the loss of the most promising of its colonial markets, the British East India Company appealed to Parliament for aid, and was permitted to export tea, a privilege it had never before enjoyed. Cargoes were sent on consignment to selected commissioners in Boston, New York, Philadelphia, and Charleston. The story of the subsequent happenings properly belongs in a book on tea. It is sufficient here to refer to the climax of the agitation against the fateful tea tax, because it is undoubtedly responsible for our becoming a nation of coffee drinkers instead of tea drinkers, like the English.

The Boston "tea party" of 1773, when citizens of Boston, disguised as Indians, boarded the English ships lying in Boston harbor and threw their tea cargoes into the



AN EARLY FAMILY COFFEE ROASTER

This machine, known in Holland as a "Coffee Burner," was used late in the 18th century in New England. It hung in the fireplace or stood in the embers.



HISTORICAL RELICS ASSOCIATED WITH THE EARLY DAYS OF COFFEE IN NEW ENGLAND

These exhibits are in the Museum of the Maine Historical Society at Portland. On the left is Kenrich's Patent coffee mill. In the center is a Britannia urn with an iron bar for heating the liquid. The bar was encased in a tin receptacle that hung inside the cover. On the right is a wall-type coffee or spice grinder.

bay, cast the die for coffee; for there and then originated a subtle prejudice against "the cup that cheers," which one hundred and sixty years have failed entirely to overcome. Meanwhile, the change wrought in our social customs by this act, and those of like nature following it, in the New York, Pennsylvania, and Charleston colonies, caused coffee to be crowned "king of the American breakfast table," and the sovereign drink of the American people.

#### *Coffee in Colonial New England*

The history of coffee in colonial New England is so closely interwoven with the story of the inns and taverns that it is difficult to distinguish the genuine coffee house, as it was known in England, from the public house where lodgings and liquors were to be had. The coffee drink had strong competition from the heady wines, the liquors, and imported teas, and consequently it did not attain the vogue among the colonial New Englanders that it did among Londoners of the late seventeenth and early eighteenth centuries.

Although New England had its coffee houses, these were actually taverns where coffee was only one of the beverages served to patrons. "They were," says Robinson, "generally meeting places of those who were conservative in their views regarding church and state, being friends of the rul-

ing administration. Such persons were termed 'Courtiers' by their adversaries, the Dissenters and Republicans."

Most of the coffee houses were established in Boston, the metropolis of the Massachusetts Colony, and the social center of New England. While Plymouth, Salem, Chelsea, and Providence had taverns that served coffee, they did not achieve the name and fame of some of the more celebrated coffee houses in Boston.

It is not definitely known when the first coffee was brought in; but it is reasonable to suppose that it came as part of the household supplies of some settler, probably between 1660 and 1670, who had become acquainted with it before leaving England. Or it may have been introduced by some British officer, who in London had made the rounds of the more celebrated coffee houses of the latter half of the seventeenth century.

#### *The First Coffee License*

According to early town records of Boston, Dorothy Jones was the first to be licensed to sell "coffee and cuchaletto," the latter being the seventeenth-century spelling for chocolate or cocoa. This license is dated 1670, and is said to be the first written reference to coffee in the Massachusetts Colony. It is not stated whether Dorothy Jones was a vender of the coffee



THE MAYFLOWER "COFFEE GRINDER"

Mortar and pestle for "braying" coffee to make coffee powder, brought over in the Mayflower by the parents of Peregrine White.

drink or of "coffee powder," as ground coffee was known in the early days.

There is some question as to whether Dorothy Jones was the first to sell coffee as a beverage in Boston. Londoners had known and drunk coffee for eighteen years before Dorothy Jones got her coffee license. British government officials were frequently taking ship from London to the Massachusetts Colony, and it is likely that they brought tidings and samples of the coffee the English gentry had lately taken up. No doubt they also told about the new-style coffee houses that were becoming popular in all parts of London. And it may be assumed that their tales caused the landlords of the inns and taverns of colonial Boston to add coffee to their lists of beverages.

#### *New England's First Coffee House*

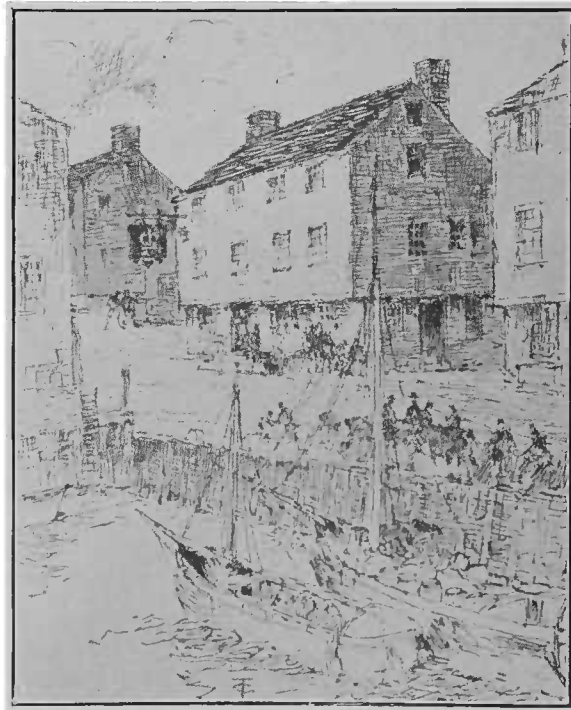
The name coffee house did not come into use in New England until late in the seventeenth century. Early colonial records do not make it clear whether the London coffee house or the Gutteridge coffee house was the first to be opened in Boston with that distinctive title. In all likelihood the London is entitled to the honor, for Samuel Gardner Drake in his *History and Antiquities of the City of Boston*, published in 1854, says that "Benj. Harris sold books there in 1689." Drake seems to be the only historian of early Boston to mention the London coffee house.

Granting that the London coffee house was the first in Boston, then the Gutteridge coffee house was the second. The latter stood on the north side of State Street, between Exchange and Washington Streets, and was named after Robert Gutteridge, who took out an innkeeper's license in 1691. Twenty-seven years later, his widow, Mary Gutteridge, petitioned the town for a renewal of her late husband's permit to keep a public coffee house.

The British coffee house, which became the American coffee house when the crown officers and all things British became obnoxious to the colonists, also began its career about the time Gutteridge took out his license. It stood on the site that is now 66 State Street, and became one of the most widely known coffee houses in colonial New England.

Of course, there were several inns and taverns in existence in Boston long before coffee and coffee houses came to the New England metropolis. Some of these taverns took up coffee when it became fashionable in the colony, and served it to those patrons who did not care for the stronger drinks.

The earliest known inn was set up by Samuel Cole in Washington Street, midway between Faneuil Hall and State Street.



THE CROWN COFFEE HOUSE, BOSTON

One of the first in New England to bear the distinctive name of coffee house; opened in 1711 and burned down in 1780.



COFFEE-MAKING AND SERVING DEVICES USED IN THE MASSACHUSETTS COLONY

These exhibits are in the Museum of the Essex Institute at Salem, Mass. *Top row, left to right, Britannia serving pots; center, Britannia table urn; bottom row, left end, tin coffee making pot; center, Britannia serving pots; right end, tin French drip pot.*

Cole was licensed as a "comfit maker" in 1634, four years after the founding of Boston; and two years later, his inn was the temporary abiding place of the Indian chief Miantonomoh and his red warriors, who came to visit Governor Vane. In the following year, the Earl of Marlborough found that Colé's inn was so "exceedingly well governed," and afforded so desirable privacy, that he refused the hospitality of Governor Winthrop at the governor's mansion.

Another popular inn of the day was the Red Lyon, which was opened in 1637 by Nicholas Upshall, the Quaker, who later was hanged for trying to bribe a jailer to pass some food into the jail to two Quakeresses who were starving within.

Ship tavern, erected in 1650, at the corner of North and Clark Streets, then on the waterfront, was a haunt of British government officials. The father of Governor Hutchinson was the first landlord, to be succeeded in 1663 by John Vyal. Here lived the four commissioners who were sent to these shores by King Charles II to settle the disputes then beginning between the colonies and England.

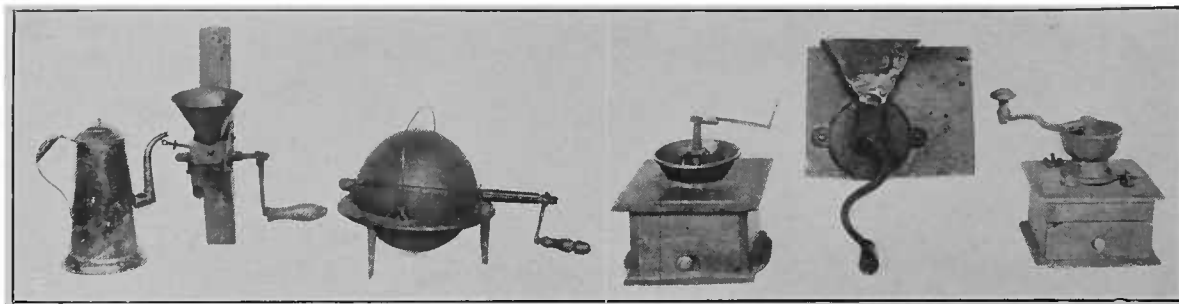
Another lodging and eating place for the

gentlemen of quality in the first days of Boston was the Blue Anchor, in Cornhill, which was conducted in 1664 by Robert Turner. Here gathered members of the government, visiting officials, jurists, and the clergy, summoned into synod by the Massachusetts General Court. It is assumed that the clergy confined their drinking to coffee and other moderate beverages, leaving the wines and liquors to their confrères.

#### *Some Notable Boston Coffee Houses*

In the last quarter of the seventeenth century quite a number of taverns and inns sprang up. Among the most notable that have obtained recognition in Boston's historical records were the King's Head, at the corner of Fleet and North Streets; the Indian Queen, on a passageway leading from Washington Street to Hawley Street; the Sun, in Faneuil Hall Square, and the Green Dragon, which became one of the most celebrated coffee-house taverns.

The King's Head, opened in 1691, early became a rendezvous of crown officers and the citizens in the higher strata of colonial society.



COFFEE DEVICES THAT FIGURED IN THE PIONEERING OF THE GREAT WEST

Photographed for this work in the Museum of the State Historical Society of Wisconsin. *Left to right*, English decorated tin pot; coffee and spice mill from Lexington, Mass.; Globe roaster built by Rays & Wilcox Co., Berlin, Conn., under Wood's patent; sheet-brass coffee mill from Lexington, Mass.; John Luther's coffee mill, Warren, R. I.; castiron hopper mill.

The Indian Queen also became a favorite resort of the crown officers from Province House. Started by Nathaniel Bishop about 1673, it stood for more than 145 years as the Indian Queen, and then was replaced by the Washington coffee house, which became noted throughout New England as the starting place for the Roxbury "hourlies," the stage coaches that ran every hour from Boston to nearby Roxbury.

The Sun tavern lived a longer life than any other Boston inn. Started in 1690 in Faneuil Hall Square, it was still standing in 1902, according to Henry R. Blaney; but has since been razed to make way for a modern building.

#### *New England's Most Famous Coffee House*

The Green Dragon, the last of the inns that were popular at the close of the seventeenth century, was the most celebrated of

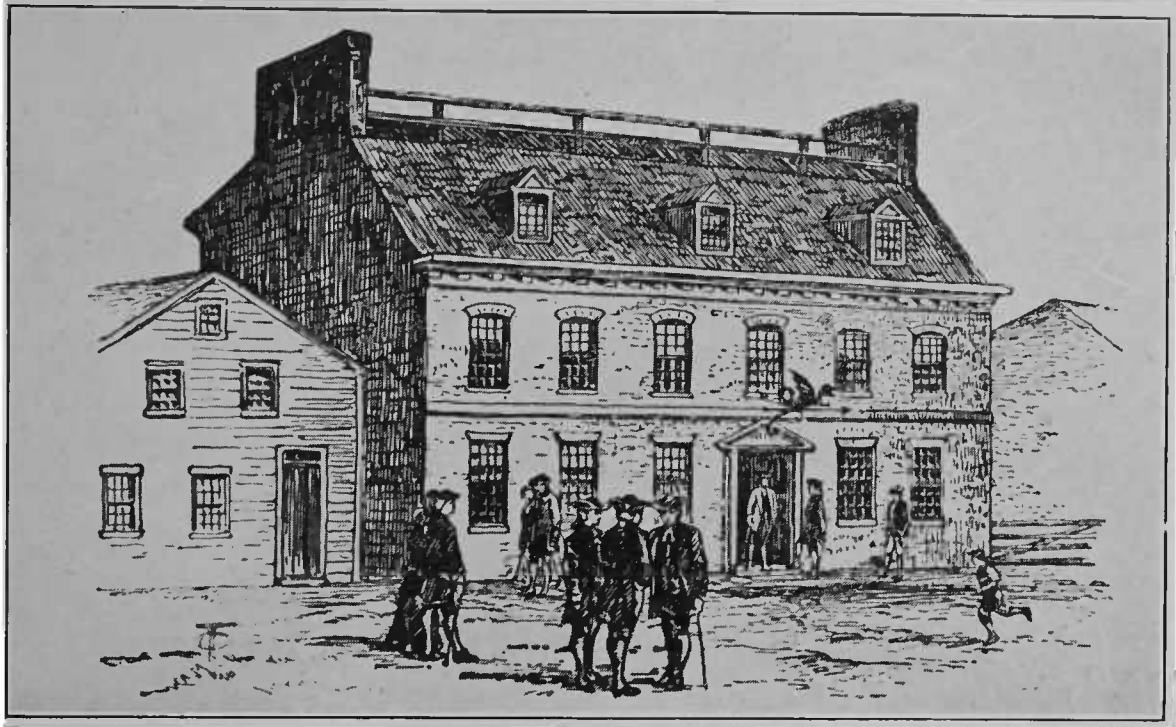
Boston's coffee-house taverns. It stood on Union Street, in the heart of the town's business center, for 135 years, from 1697 to 1832, and figured in practically all the important local and national events during its long career. Red-coated British soldiers, colonial governors, bewigged crown officers, earls and dukes, citizens of high estate, plotting revolutionists of lesser degree, conspirators in the Boston Tea Party, patriots and generals of the Revolution—all these were wont to gather at the Green Dragon to discuss their various interests over their cups of coffee, and stronger drinks. In the words of Daniel Webster, this famous coffee-house tavern was the "headquarters of the Revolution." It was here that Warren, John Adams, James Otis, and Paul Revere met as a "ways and means committee" to secure freedom for the American colonies. Here, too, came members of the Grand Lodge of Masons to hold their meet-



METAL AND CHINA COFFEE POTS USED IN NEW ENGLAND'S COLONIAL DAYS

From the collection in the Museum of the Pocumtuck Valley Memorial Association, Deerfield, Mass.





THE GREEN DRAGON, THE CENTER OF SOCIAL AND POLITICAL LIFE IN BOSTON FOR 135 YEARS

This tavern figured in practically all the important national affairs from 1697 to 1832, and, according to Daniel Webster, was the "headquarters of the Revolution."

ings under the guidance of Warren, who was the first grand master of the first Masonic lodge in Boston. The site of the old tavern, now occupied by a business block, is still the property of the St. Andrew's Lodge of Free Masons. The old tavern was a two-storied brick structure with a sharply pitched roof. Over its entrance hung a sign bearing the figure of a green dragon.

Patrons of the Green Dragon and the British coffee house were decidedly opposed in their views on the questions of the day. While the Green Dragon was the gathering place of the patriotic colonials, the British was the rendezvous of the loyalists, and frequent were the encounters between the patrons of these two celebrated taverns. It was in the British coffee house that James Otis was so badly pummeled, after being lured there by political enemies, that he never regained his former brilliancy as an orator.

It was there, in 1750, that some British red coats staged the first theatrical entertainment given in Boston, playing Otway's *Orphan*. There, the first organization of citizens to take the name of a club formed the Merchants' Club in 1751. The membership included officers of the king, colonial

governors and lesser officials, military and naval leaders, and members of the bar, with a sprinkling of high-ranking citizens who were staunch friends of the crown. However, the British became so generally disliked that as soon as the king's troops evacuated Boston in the Revolution, the name of the coffee house was changed to the American.

The Bunch of Grapes, that Francis Holmes presided over as early as 1712, was another hot-bed of politicians. Like the Green Dragon over the way, its patrons included unconditional freedom seekers, many coming from the British coffee house when things became too hot for them in that Tory atmosphere. The Bunch of Grapes became the center of a stirring celebration in 1776, when a delegate from Philadelphia read the Declaration of Independence from the balcony of the inn to the crowd assembled in the street below. So enthusiastic did the Bostonians become that, in the excitement that followed, the inn was nearly destroyed when one enthusiast built a bonfire too close to its walls. Another anecdote told of the Bunch of Grapes concerns Sir William Phipps, governor of Massachusetts from 1692-94, who was noted for his irascibility. He had his

favorite chair and window in the inn, and in the accounts of the period it is written that on any fine afternoon his glowering countenance could be seen at the window by the passers-by on State Street.

After the beginning of the eighteenth century the title of coffee house was applied to a number of hostelrys opened in Boston. One of these was the Crown, which was opened in the "first house on Long Wharf" in 1711 by Jonathan Belcher, who later became governor of Massachusetts, and still later of New Jersey. The first landlord of the Crown was Thomas Selby, who by trade was a periwig maker, but probably found the selling of strong drink and coffee more profitable. Selby's coffee house was also used as an auction room. The Crown stood until 1780, when it was destroyed in a fire that swept the Long Wharf. On its site now stands the Fidelity Trust Company at 148 State Street.

Another early Boston coffee house on State Street was the Royal Exchange. How long it had been standing before it was first mentioned in colonial records in 1711 is unknown. It occupied an ancient two-story building, and was kept in 1711 by Benjamin Johns. This coffee house became the starting place for stage coaches running between Boston and New York, the first one leaving September 7, 1772. In the *Columbian Centinel* of January 1, 1800, appeared

an advertisement in which it was said: "New York and Providence Mail Stage leaves Major Hatches' Royal Exchange Coffee House in State Street every morning at 8 o'clock."

In the latter half of the eighteenth century the North-End coffee house was celebrated as the highest-class coffee house in Boston. It occupied the three-storied brick mansion which had been built about 1740 by Edward Hutchinson, brother of the noted governor. It stood on the west side of North Street, between Sun Court and Fleet Street, and was one of the most pretentious of its kind. An eighteenth century writer, in describing this coffee-house mansion, made much of the fact that it had forty-five windows and was valued at \$4,500, a large sum for those days. During the Revolution, Captain David Porter, father of Admiral David D. Porter, was the landlord, and under him it became celebrated throughout the city as a high-grade eating place. The advertisements of the North-End coffee house featured its "dinners and suppers—small and retired rooms for small company—oyster suppers in the nicest manner."

#### A "Skyscraper" Coffee House

The Boston coffee-house period reached its height in 1808, when the doors of the



METAL COFFEE POTS USED IN THE NEW YORK COLONY

Left, tin coffee pot, dark brown, with "love apple" decoration in red. New Jersey Historical Society, Newark; right, weighted-bottom tin pot with rose decoration, private owner

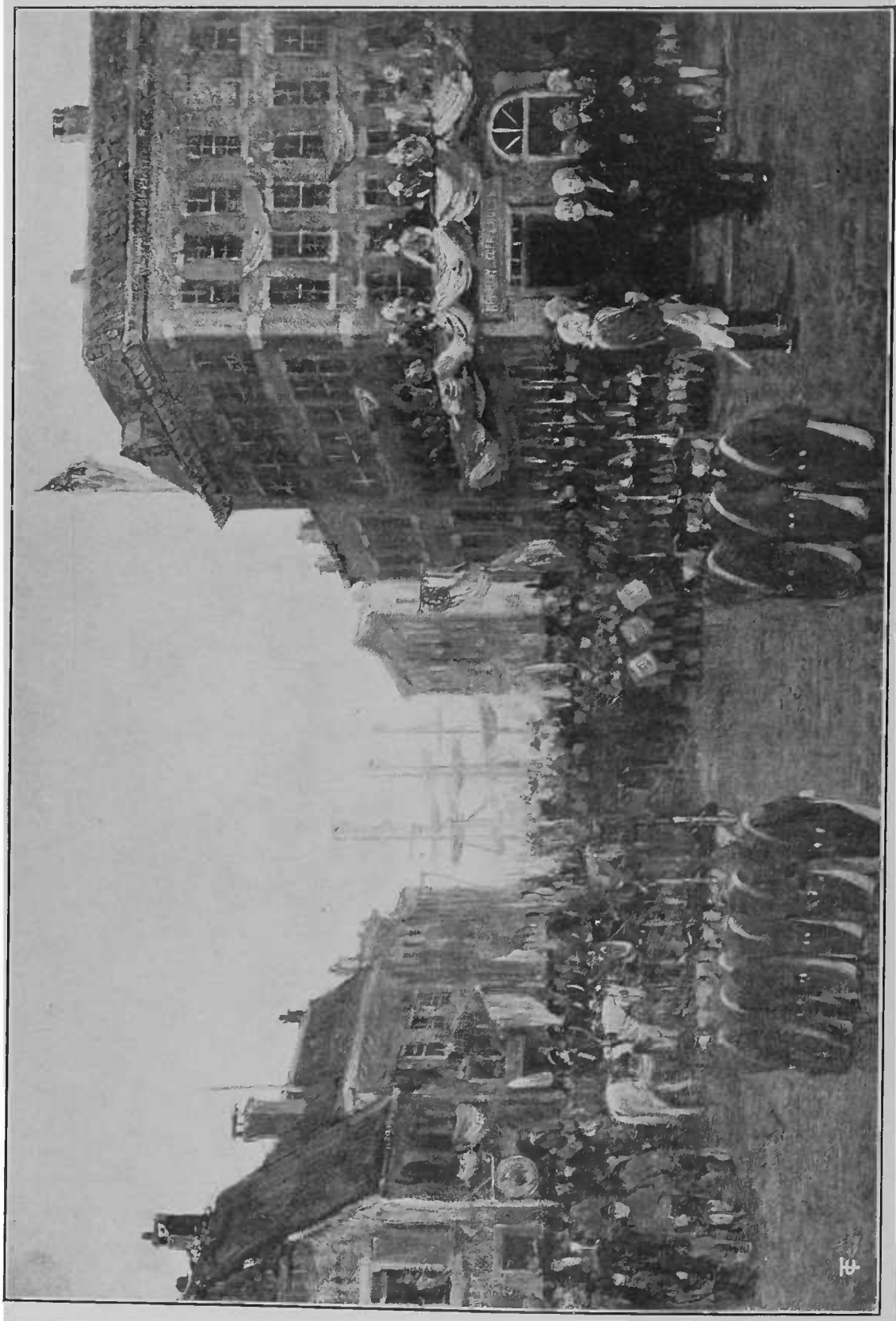


**EXCHANGE COFFEE HOUSE, BOSTON, 1808 PROBABLY THE LARGEST AND MOST COSTLY IN THE WORLD**  
 Built of stone, marble, and brick, it stood seven stories high and cost \$500,000. It was patterned after Lloyd's of London, and was the center of marine intelligence in Boston.

Exchange coffee house were thrown open after three years of building. This structure, situated on Congress Street near State Street, was the skyscraper of its day, and probably was the most ambitious coffee-house project the world has known. Built of stone, marble, and brick, it stood seven stories high, and cost a half-million dollars. Charles Bulfinch, America's most noted architect of that period, was the designer.

Like Lloyd's coffee house in London, the Exchange was the center of marine intelligence, and its public rooms were thronged all day and evening with mariners, naval officers, ship and insurance brokers, who had come to talk shop or to consult the

records of ship arrivals and departures, manifests, charters, and other marine papers. The first floor of the Exchange was devoted to trading. On the next floor was the large dining room, where many sumptuous banquets were given, notably the one to President Monroe in July, 1817, which was attended by former President John Adams, and by many generals, commodores, governors, and judges. The other floors were given over to living and sleeping rooms, of which there were more than 200. The Exchange coffee house was destroyed by fire in 1818; and on its site was erected another, bearing the same name, but having slight resemblance to its predecessor.



**PRESIDENT-ELECT WASHINGTON WELCOMED AT THE MERCHANTS COFFEE HOUSE, NEW YORK**  
The reception took place April 23, 1789, one week before his inauguration. From a painting by Charles P. Gruppe, owned by the author.

## CHAPTER XII

### HISTORY OF COFFEE IN OLD NEW YORK

THE BURGHERS OF NEW AMSTERDAM BEGIN TO SUBSTITUTE COFFEE FOR "MUST," OR BEER, AT BREAKFAST IN 1668—WILLIAM PENN MAKES HIS FIRST PURCHASE OF COFFEE IN THE GREEN BEAN FROM NEW YORK MERCHANTS IN 1683—THE KING'S ARMS, THE FIRST COFFEE HOUSE—THE HISTORIC MERCHANTS, SOMETIMES CALLED THE "BIRTH-PLACE OF OUR UNION"—THE COFFEE HOUSE AS A CIVIC FORUM—THE EXCHANGE, WHITEHALL, BURNS, TONTINE, AND OTHER CELEBRATED COFFEE HOUSES—THE VAUXHALL AND RANELAGH PLEASURE GARDENS

THE Dutch founders of New York seem to have introduced tea into New Amsterdam before they brought in coffee. This was somewhere about the middle of the seventeenth century. We find it recorded that about 1668 the burghers succumbed to coffee.<sup>1</sup> Coffee made its way slowly, first in the homes, where it replaced the "must," or beer, at breakfast. Chocolate came about the same time, but was more of a luxury than tea or coffee.

After the surrender of New York to the British in 1674, English manners and customs were rapidly introduced. First tea, and later coffee, were favorite beverages in the homes. By 1683 New York had become so central a market for the green bean, that William Penn, as soon as he found himself comfortably settled in the Pennsylvania Colony, sent over to New York for his coffee supplies.<sup>2</sup> It was not long before a social need arose that only the London style of coffee house could fill.

#### *Coffee-House Activities*

The coffee houses of early New York, like their prototypes in London, Paris, and other old world capitals, were the centers of the business, political and, to some extent, of the social life of the city. But they never became the forcing-beds of literature

<sup>1</sup> Singleton, Esther. *Dutch New York*. 1909. (p. 133.)

<sup>2</sup> Bishop, J. Leander. *A History of American Manufactures, 1608 to 1860*. New York.

that the French and English houses were, principally because the colonists had no professional writers of note.

There is one outstanding feature of the early American coffee houses, particularly of those opened in New York, that is not distinctive of the European houses. The colonists sometimes held court trials in the long, or assembly, room of the early coffee houses; and often held their general assembly and council meetings there.

#### *The Coffee House as a Civic Forum*

The early coffee house was an important factor in New York life. What the perpetuation of this public gathering place meant of the citizens is shown by a complaint, evidently designed to revive the declining fortunes of the historic Merchants coffee house, in the *New York Journal* of October 19, 1775, which, in part, read:

To the Inhabitants of New York:

It gives me concern, in this time of public difficulty and danger, to find we have in this city no place of daily general meeting, where we might hear and communicate intelligence from every quarter and freely confer with one another on every matter that concerns us. Such a place of general meeting is of very great advantage in many respects, especially at such a time as this, besides the satisfaction it affords and the sociable disposition it has a tendency to keep up among us, which was never more wanted than at this time. To answer all these and many other good and useful purposes, coffee houses have been universally deemed the most conve-



nient places of resort, because, at a small expense of time or money, persons wanted may be found and spoke with, appointments may be made, current news heard, and whatever it most concerns us to know. In all cities, therefore, and large towns that I have seen in the British dominions, sufficient encouragement has been given to support one or more coffee houses in a genteel manner. How comes it then that New York, the most central, and one of the largest and most prosperous cities in British America, cannot support one coffee house? It is a scandal to the city and its inhabitants to be destitute of such a convenience for want of due encouragement. A coffee house, indeed, there is, a very good and comfortable one, extremely well tended and accommodated, but it is frequented but by an inconsiderable number of people; and I have observed with surprise, that but a small part of those who do frequent it, contribute anything at all to the expense of it, but come in and go out without calling for or paying anything to the house. In all the coffee houses in London, it is customary for everyone that comes in to call for at least a dish of coffee, or leave the value of one, which is but reasonable, because when the keepers of these houses have been at the expense of setting them up and providing all necessaries for the accommodation of company, every one that comes to receive the

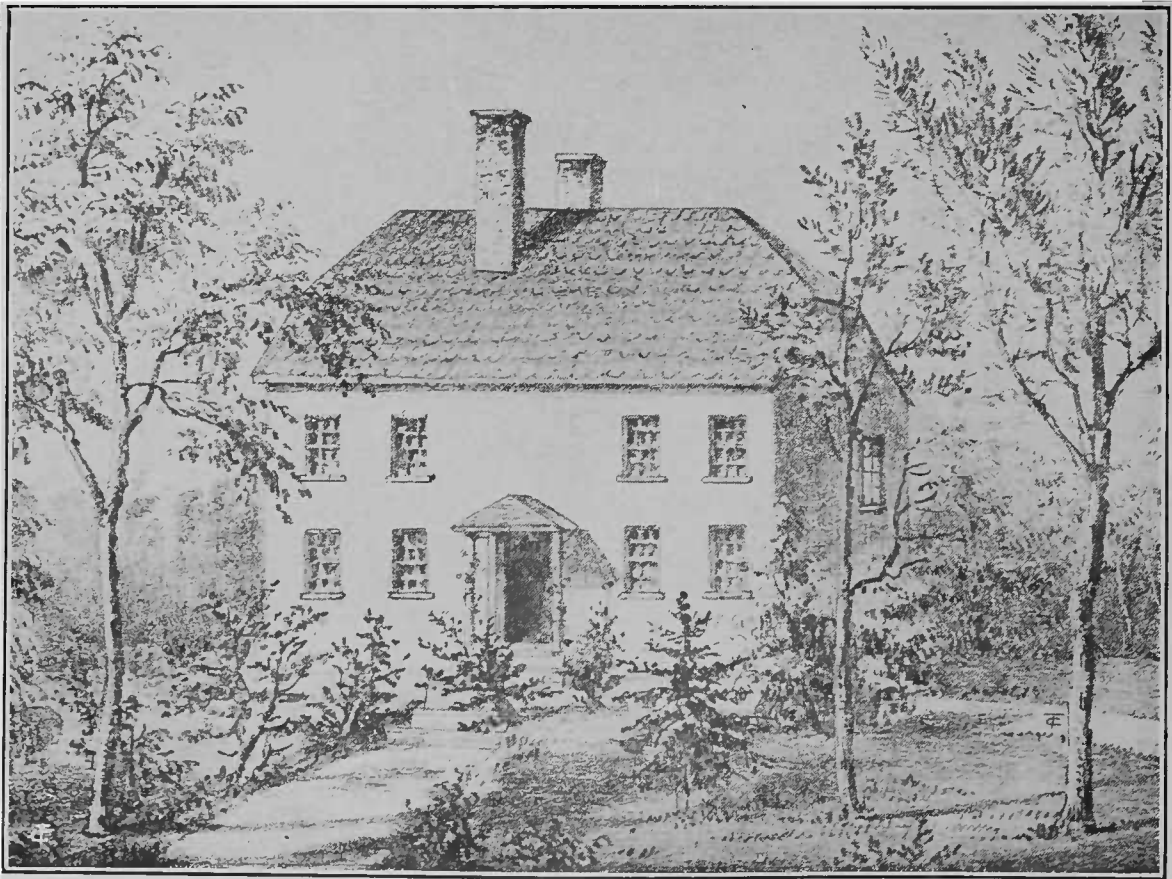
benefit of these conveniences ought to contribute something towards the expense of them.

A FRIEND TO THE CITY.

#### *New York's First Coffee House*

Some chroniclers of New York's early days are confident that the first coffee house in America was opened in New York; but the earliest authenticated record they have presented is that on November 1, 1696, John Hutchins bought a lot on Broadway, between Trinity churchyard and what is now Cedar Street, and there built a house, naming it the King's Arms. Against this record, Boston can present the statement in Samuel Gardner Drake's *History and Antiquities of the City of Boston* that Benj. Harris sold books at the "London Coffee House" in 1689.

The King's Arms was built of wood, and had a front of yellow brick, said to have been brought from Holland. The building was two stories high, and on the roof was an "observatory," arranged with seats, and



NEW YORK'S PIONEER COFFEE HOUSE, THE KING'S ARMS, OPENED IN 1696

This view shows the garden side of the historic old house as it was conducted by John Hutchins, near Trinity Church, on Broadway. The observatory may have been added later.



BURNS COFFEE HOUSE AS IT APPEARED ABOUT THE MIDDLE OF THE NINETEENTH CENTURY

It stood for many years on Broadway, opposite Bowling Green, in the old De Lancey House, becoming known in 1763 as the King's Arms, and later as the Atlantic Garden House.

commanding a fine view of the bay, the river, and the city. Here the coffee-house visitors frequently sat in the afternoons. It is not shown in the illustration.

The sides of the main room on the lower floor were lined with booths, which, for the sake of greater privacy, were screened with green curtains. There a patron could sip his coffee, or a more stimulating drink, and look over his mail in the same exclusiveness affected by the Londoner of the time.

The rooms on the second floor were used for special meetings of merchants, colonial magistrates and overseers, or similar public and private business.

The meeting room, as above described, seems to have been one of the chief features distinguishing a coffee house from a tavern. Although both types of houses had rooms for guests, and served meals, the coffee house was used for business purposes by permanent customers, while the tavern was patronized more by transients. Men met at the coffee house daily to carry on business, and went to the tavern for convivial purposes or lodgings. Before the front door

hung the sign of "the lion and the unicorn fighting for the crown."

For many years the King's Arms was the only coffee house in the city; or at least no other seems of sufficient importance to have been mentioned in colonial records. For this reason it was more frequently designated as "the" coffee house than the King's Arms. Contemporary records of the arrest of John Hutchins of the King's Arms, and of Roger Baker, for speaking disrespectfully of King George, mention the King's Head, of which Baker was proprietor. But it is generally believed that this public house was a tavern and not rightfully to be considered as a coffee house. The White Lion, mentioned about 1700, was also a tavern, or inn.

#### *The New Coffee House*

Under date of September 22, 1709, the *Journal of the General Assembly of the Colony of New York* refers to a conference held in the "New" coffee house. About this date the business section of the city had begun to drift eastward from

Broadway to the waterfront; and from this fact it is assumed that the name "New" coffee house indicates that the King's Arms had been removed from its original location near Cedar Street, or that it may have lost favor and been superseded in popularity by a newer coffee house. The *Journal* does not give the location of the "New" coffee house. Whatever the case may be, the name of the King's Arms does not again appear in the records until 1763, and then it had more the character of a tavern, or roadhouse.

The public records from 1709 up to 1729 are silent in regard to coffee houses in New York. In 1725 the pioneer newspaper in the city, the *New York Gazette*, came into existence; and four years later, 1729, there appeared in it an advertisement stating that "a competent bookkeeper may be heard of" at the "Coffee House." In 1730 another advertisement in the same journal tells of a sale of land by public vendue, or auction, to be held at the Exchange coffee house.

#### *The Exchange Coffee House*

By reason of its name, the Exchange coffee house is thought to have been located at the foot of Broad Street, abutting the sea-wall and near the Long Bridge of that day. At that time this section was the business center of the city, and included a trading exchange.

That the Exchange coffee house was the only one of its kind in New York in 1732 is inferred from the announcement in that year of a meeting of the conference committee of the Council and Assembly "at the Coffee House." In seeming confirmation of this conclusion, is the advertisement in 1733 in the *New York Gazette* requesting the return of "lost sleeve buttons to Mr. Todd, next door to the Coffee House." The records of the day show that a Robert Todd kept the famous Black Horse tavern which was located in this part of the city.

Again we hear of the Exchange coffee house in 1737, and apparently in the same location, where it is mentioned in an account of the "Negro plot" as being next door to the Fighting Cocks tavern by the Long Bridge, at the foot of Broad Street. Also in this same year it is named as the place of public vendue of land situated on Broadway.

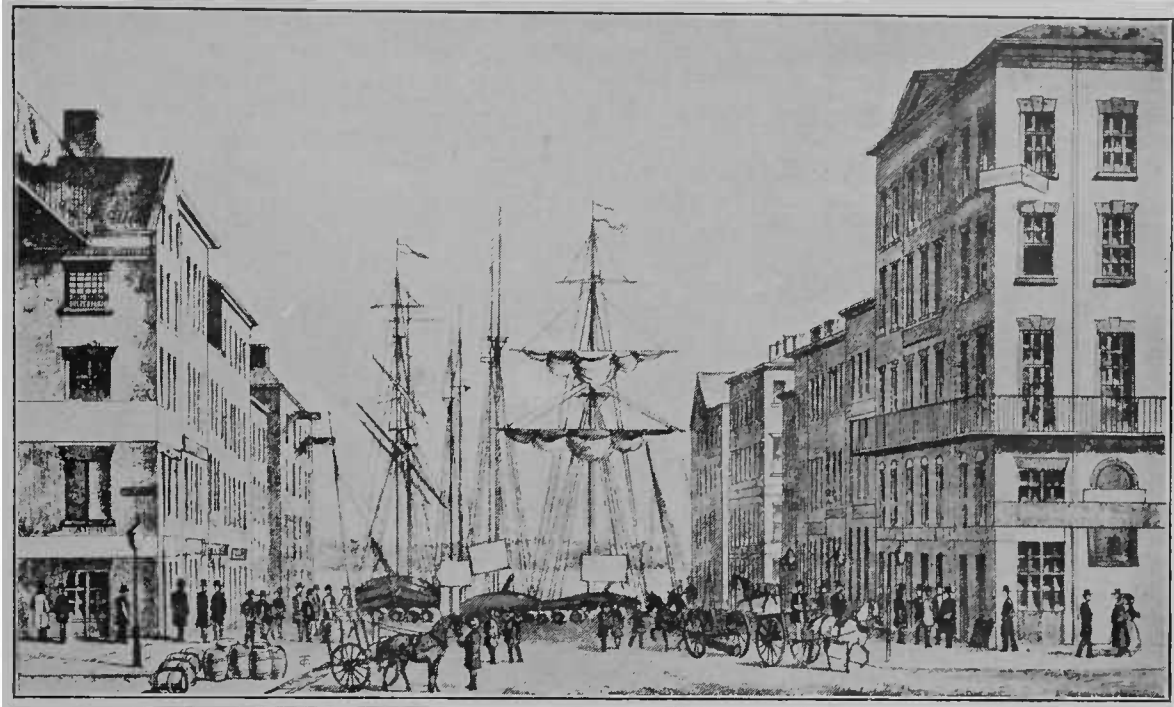
By this time the Exchange coffee house had virtually become the city's official auction room, as well as the place to buy and to drink coffee. Commodities of many kinds were also bought and sold there, both within the house and on the sidewalk before it.

#### *The Merchants Coffee House*

In the year 1750, the Exchange coffee house had begun to lose its long-held prestige, and its name was changed to the Gentlemen's Exchange coffee house and tavern. A year later it had migrated to Broadway under the name of the Gentlemen's coffee house and tavern. In 1753 it was moved again, to Hunter's Quay, which was situated on what is now Front Street, somewhere between the present Old Slip and Wall Street. The famous old coffee house seems to have gone out of existence about this time, its passing hastened, no doubt, by the newer enterprise, the Merchants coffee house, which was to become the most celebrated in New York, and, according to some writers, the most historic in America.

It is not certain just when the Merchants coffee house was first opened. As near as can be determined, Daniel Bloom, a mariner, in 1737 bought the Jamaica Pilot Boat tavern from John Dunks and named it the Merchants coffee house. The building was situated on the northwest corner of the present Wall Street and Water (then Queen) Street; and Bloom was its landlord until his death, soon after the year 1750. He was succeeded by Captain James Ackland, who shortly sold it to Luke Roome. The latter disposed of the building in 1758 to Dr. Charles Arding. The doctor leased it to Mrs. Mary Ferrari, who continued as its proprietor until she moved, in 1772, to the newer building diagonally across the street, built by William Brownejohn, on the southeast corner of Wall and Water Streets. Mrs. Ferrari took with her the patronage and the name of the Merchants coffee house, and the old building was not used again as a coffee house.

The building housing the original Merchants coffee house was a two-story structure, with a balcony on the roof, which was typical of middle eighteenth century architecture in New York. On the first floor were the coffee bar and booths described in connection with the King's Arms coffee



MERCHANTS COFFEE HOUSE, AT THE RIGHT, AS IT APPEARED FROM 1772 TO 1804

The original coffee house of this name was opened on the northwest corner of Wall and Water Streets about 1737, the business being moved to the southeast corner in 1772.

house. The second floor had the typical long room for public assembly.

During Bloom's proprietorship the Merchants coffee house had a long, hard struggle to win the patronage away from the Exchange coffee house, which was flourishing at that time. But, being located near the Meal Market, where the merchants were wont to gather for trading purposes, it gradually became the meeting place of the city, at the expense of the Exchange coffee house, farther down the waterfront.

Widow Ferrari presided over the original Merchants coffee house for fourteen years, until she moved across the street. She was a keen business woman. Just before she was ready to open the new coffee house she announced to her old patrons that she would give a house-warming, at which arrack, punch, wine, cold ham, tongue, and other delicacies of the day would be served. The event was duly noted in the newspapers, one stating that "the agreeable situation and the elegance of the new house had occasioned a great resort of company to it."

Mrs. Ferrari continued in charge until May 1, 1776, when Cornelius Bradford became proprietor and sought to build up the patronage, that had dwindled somewhat

during the stirring days immediately preceding the Revolution. In his announcement of the change of ownership, he said, "Interesting intelligence will be carefully collected and the greatest attention will be given to the arrival of vessels, when trade and navigation shall resume their former channels." He referred to the complete embargo of trade to Europe which the colonists were enduring. When the American troops withdrew from the city during the Revolution, Bradford went also, to Rhinebeck on the Hudson.

During the British occupation, the Merchants coffee house was a place of great activity. As before, it was the center of trading, and under the British régime it became also the place where the prize ships were sold. The Chamber of Commerce resumed its sessions in the upper long room in 1779, having been suspended since 1775. The Chamber paid fifty pounds rent per annum for the use of the room to Mrs. Smith, the landlady at the time.

In 1781 John Stachan, then proprietor of the Queen's Head tavern, became landlord of the Merchants coffee house, and he promised in a public announcement "to pay attention not only as a Coffee House, but as a tavern, in the truest; and to dis-

tinguish the same as the City Tavern and Coffee House, with constant and best attendance. Breakfast from seven to eleven; soups and relishes from eleven to half-past one. Tea, coffee, etc., in the afternoon, as in England." But when he began charging sixpence for receiving and dispatching letters by man-o'-war to England, he brought a storm about his ears, and was forced to give up the practise. He continued in charge until peace came, and Cornelius Bradford came with it to resume proprietorship of the coffee house.

Bradford changed the name to the New York coffee house, but the public continued to call it by its original name, and the landlord soon gave in. He kept a marine list, giving the names of vessels arriving and departing, recording their ports of sailing. He also opened a register of returning citizens, "where any gentleman now resident in the city," his advertisement stated, "may insert their names and place of residence." This seems to have been the first attempt at a city directory. By his energy Bradford soon made the Merchants coffee house again the business center of the city. When he died, in 1786, he was mourned as one of the leading citizens. His funeral was held at the coffee house over which he had presided so well.

The Merchants coffee house continued to be the principal public gathering place until it was destroyed by fire in 1804. During its existence it had figured prominently in many of the local and national historic events, too numerous to record here in detail.

Some of the famous events were: The reading of the order to the citizens, in 1765, warning them to stop rioting against the Stamp Act; the debates on the subject of not accepting consignments of goods from Great Britain; the demonstration by the Sons of Liberty, sometimes called the "Liberty Boys," made before Captain Lockyer of the tea ship *Nancy*, which had been turned away from Boston and sought to land its cargo in New York in 1774; the general meeting of citizens on May 19, 1774, to discuss a means of communicating with the Massachusetts colony to obtain co-ordinated effort in resisting England's oppression, out of which came the letter suggesting a congress of deputies from the colonies and calling for a "virtuous and spirited Union"; the mass meeting of citizens in the days immediately following the

battles at Concord and Lexington in Massachusetts; and the forming of the Committee of One Hundred to administer the public business, making the Merchants coffee house virtually the seat of government.

When the American Army held the city in 1776, the coffee house became the resort of army and navy officers. Its culminating glory came on April 23, 1789, when Washington, the recently elected first president of the United States, was officially greeted at the coffee house by the governor of the State, the mayor of the city, and the lesser municipal officers.

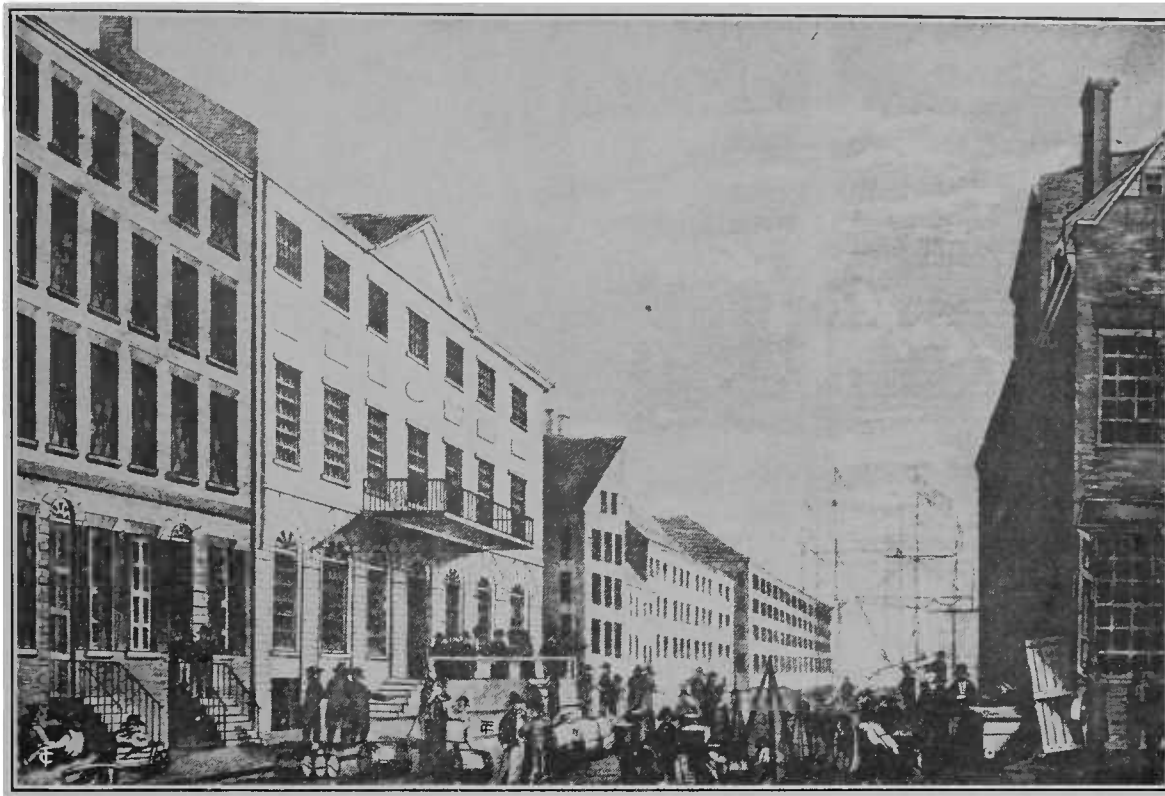
As a meeting place for societies and lodges the Merchants coffee house was long distinguished. In addition to the purely commercial organizations that gathered in its long room, these bodies regularly met there in their early days: The Society of Arts, Agriculture, and Economy; Knights of Corsica; New York Committee of Correspondence; New York Marine Society; Chamber of Commerce of the State of New York; Lodge 169, Free and Accepted Masons; Whig Society; Society of the New York Hospital; St. Andrew's Society; Society of the Cincinnati; Society of the Sons of St. Patrick; Society for Promoting the Manumission of Slaves; Society for the Relief of Distressed Debtors; Black Friars Society; Independent Rangers; and Federal Republicans.

Here also came the men who, in 1784, formed the Bank of New York, the first financial institution in the city; and here was held, in 1790, the first public sale of stocks by sworn brokers. Here, too, was held the organization meeting of subscribers to the Tontine coffee house, which in a few years was to prove a worthy rival.

#### *Some Lesser Known Coffee Houses*

Before taking up the story of the famous Tontine coffee house it should be noted that the Merchants coffee house had some prior measure of competition. For four years the Exchange coffee room sought to cater to the wants of the merchants around the foot of Broad Street. It was located in the Royal Exchange, which had been erected in 1752 in place of the old Exchange, and until 1754 had been used as a store. Then William Keen and Alexander Lightfoot got control and started their coffee room, with a ball room at-





THE TONTINE COFFEE HOUSE, SECOND BUILDING AT THE LEFT, OPENED IN 1792

This is the original structure, northwest corner of Wall and Water Streets, which was succeeded about 1850 by a five-story building (see page 118) that in turn was replaced by a modern office building.

tached. The partnership split up in 1756, Lightfoot continuing operations until he died the next year, when his widow tried to carry it on. In 1758 it had reverted into its original character of a mercantile establishment.

Then there was the Whitehall coffee house, which two men, named Rogers and Humphreys, opened in 1762, with the announcement that "a correspondence is settled in London and Bristol to remit by every opportunity all the public prints and pamphlets as soon as published; and there will be a weekly supply of New York, Boston and other American newspapers." This enterprise had a short life.

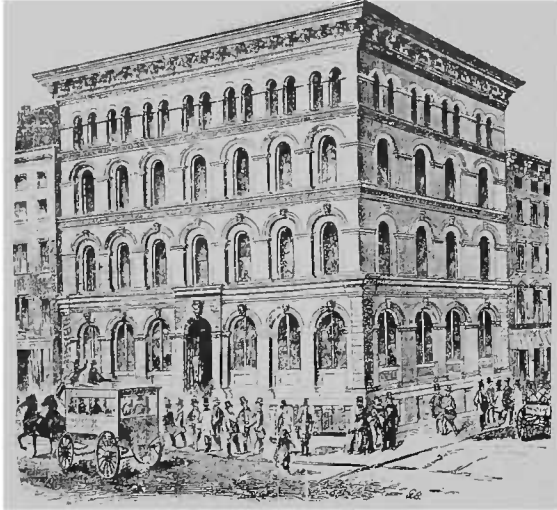
The early records of the city infrequently mention the Burns coffee house, sometimes calling it a tavern. It is likely that the place was more an inn than a coffee house. It was kept for a number of years by George Burns, near the Battery, and was located in the historic old De Lancey house, which afterward became the City hotel.

Burns remained the proprietor until 1762, when it was taken over by a Mrs.

Steele, who gave it the name of the King's Arms. Edward Barden became the landlord in 1768. In later years it became known as the Atlantic Garden house. Traitor Benedict Arnold is said to have lodged in the old tavern after deserting to the enemy.

The Bank coffee house belonged to a later generation, and had few of the characteristics of the earlier coffee houses. It was opened in 1814 by William Niblo, of Niblo's Garden fame, and stood at the corner of William and Pine Streets, at the rear of the Bank of New York. The coffee house endured for probably ten years, and became the gathering place of a coterie of prominent merchants, who formed a sort of club. The Bank coffee house became celebrated for its dinners and dinner parties.

Fraunce's tavern, best known as the place where Washington bade farewell to his army officers, was, as its name states, a tavern, and can not be properly classed as a coffee house. While coffee was served, and there was a long room for gatherings, little, if any, business was done there by



THE TONTINE BUILDING OF 1850

Northwest corner of Wall and Water Streets; an omnibus of the Broadway-Wall-Street Ferry line is passing the building.

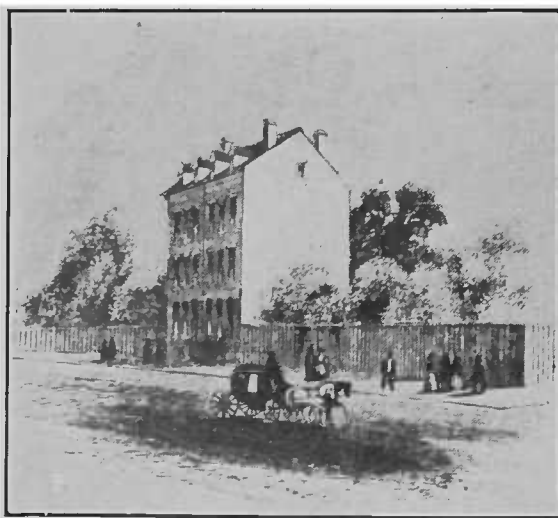
merchants. It was largely a meeting place for citizens bent on a "good time."

Then there was the New England and Quebec coffee house, which was also a tavern.

#### *The Tontine Coffee House*

The last of the celebrated coffee houses of New York bore the name Tontine coffee house. For several years after the burning of the Merchants coffee house, in 1804, it was the only one of note in the city.

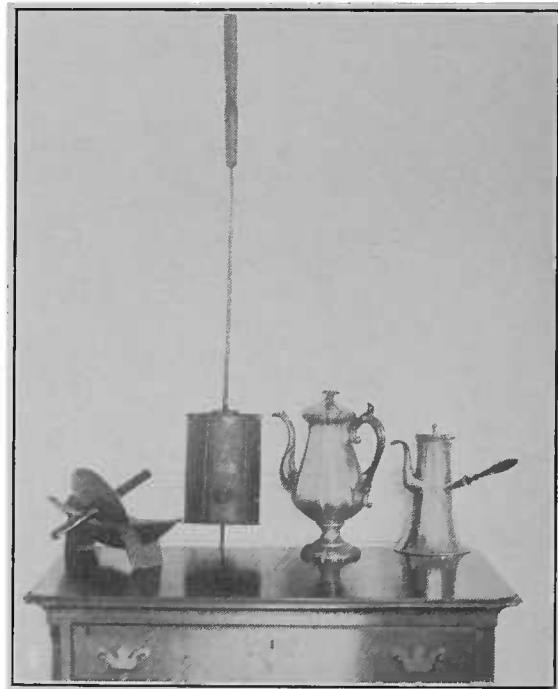
Feeling that they should have a more commodious coffee house for carrying on their various business enterprises, some 150



NIBLO'S GARDEN, BROADWAY AND PRINCE STREET,  
AS IT APPEARED IN 1828

merchants organized, in 1791, the Tontine coffee house. This enterprise was based on the plan introduced into France in 1653 by Lorenzo Tonti, with slight variations. According to the New York Tontine plan, each holder's share reverted automatically to the surviving shareholders in the association, instead of to his heirs. There were 157 original shareholders, and 203 shares of stock valued at £200 each.

The directors bought the house and lot on the northwest corner of Wall and Water Streets, where the original Merchants coffee house stood, paying £1,970. They next acquired the adjoining lots on Wall and Water Streets, paying £2,510 for the former, and £1,000 for the latter.

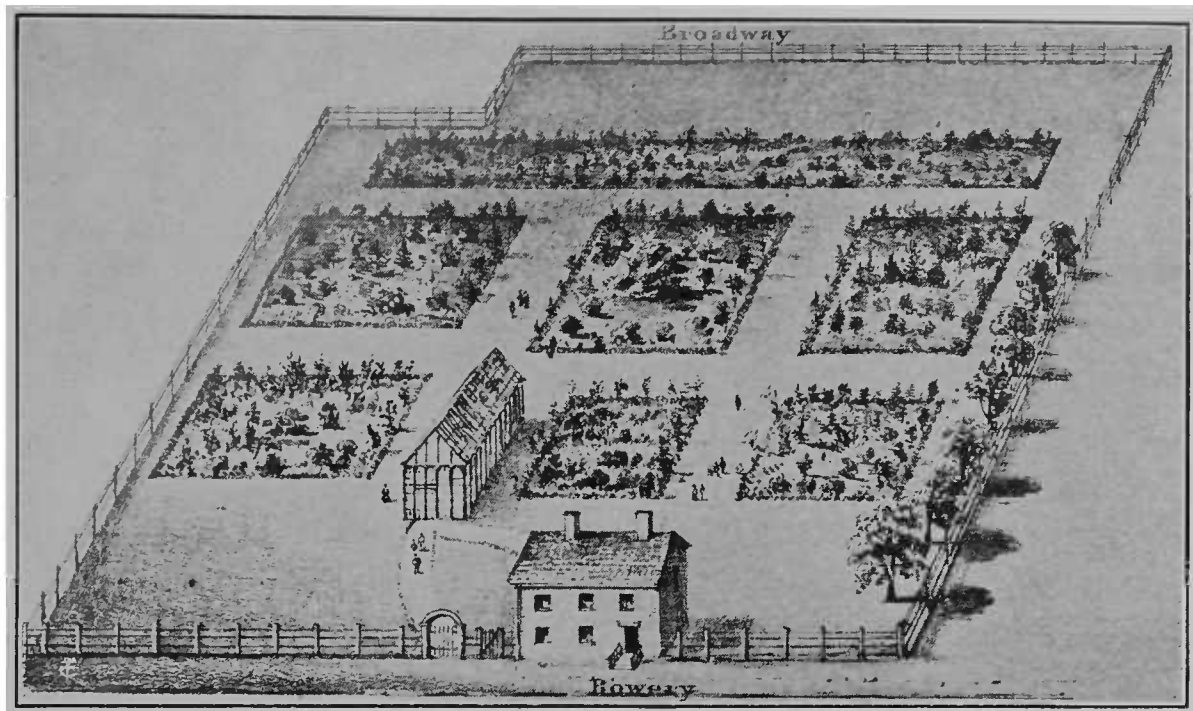


COFFEE RELICS OF DUTCH NEW YORK  
Spice-grinder boat, coffee roaster, and coffee pots at  
the Van Cortlandt Museum.

The cornerstone of the new coffee house was laid June 5, 1792; and a year later to the day, 120 gentlemen sat down to a banquet in the completed coffee house to celebrate the event of the year before. John Hyde was the first landlord. The house had cost \$43,000.

A contemporary account of how the Tontine coffee house looked in 1794 is supplied by an Englishman visiting New York at the time:

The Tontine tavern and coffee house is a handsome large brick building; you ascend six



NEW YORK'S VAUXHALL GARDEN IN 1803  
From an old print

or eight steps under a portico, into a large public room, which is the Stock Exchange of New York, where all bargains are made. Here are two books kept, as at Lloyd's [in London] of every ship's arrival and clearance. This house was built for the accommodation of the merchants by Tontine shares of two hundred pounds each. It is kept by Mr. Hyde, formerly a woolen draper in London. You can lodge and board there at a common table, and you pay ten shillings currency a day, whether you dine out or not.

The stock market made its headquarters in the Tontine coffee house in 1817, and the early organization was elaborated and became the New York Stock and Exchange Board. It was removed in 1827 to the Merchants Exchange Building, where it remained until that place was destroyed by fire in 1835.

It was stipulated in the original articles of the Tontine Association that the house was to be kept and used as a coffee house, and this agreement was adhered to up to the year 1834, when, by permission of the Court of Chancery, the premises were let for general business-office purposes. This change was due to the competition offered by the Merchants Exchange, a short distance up Wall Street, which had been opened soon after the completion of the Tontine coffee house building.

As the city grew, the business-office quar-

ters of the original Tontine coffee house became inadequate; and about the year 1850 a new five-story building, costing some \$60,000, succeeded it. By this time the building had lost its old coffee-house characteristics. This new Tontine structure is said to have been the first real office building in New York City. Today the site is occupied by a large modern office building, which still retains the name of Tontine. It was owned by John B. and Charles A. O'Donohue, well known New York coffee merchants, until 1920, when it was sold for \$1,000,000 to the Federal Sugar Refining Company.

The Tontine coffee house did not figure so prominently in the historic events of the nation and city as did its neighbor, the Merchants coffee house. However, it became the Mecca for visitors from all parts of the country, who did not consider their sojourn in the city complete until they had at least inspected what was then one of the most pretentious buildings in New York. Chroniclers of the Tontine coffee house always say that most of the leaders of the nation, together with distinguished visitors from abroad, had foregathered in the large room of the old coffee house at some time during their careers.

It was on the walls of the Tontine coffee

house that bulletins were posted on Hamilton's struggle for life after the fatal duel forced on him by Aaron Burr.

The changing of the Tontine coffee house into a purely mercantile building marked the end of the coffee-house era in New York. Exchanges and office buildings had come into existence to take the place of the business features of the coffee houses; clubs were organized to take care of the social functions; and restaurants and hotels had sprung up to cater to the needs for beverages and food.

#### *New York's Pleasure Gardens*

There was a fairly successful attempt made to introduce the London pleasure-garden idea into New York. First, tea gardens were added to several of the taverns already provided with ball rooms. Then, on the outskirts of the city, were opened the Vauxhall and the Ranelagh gardens, so named after their famous London prototypes. The first Vauxhall garden, there were three of this name, was on Greenwich Street, between Warren and Chambers Streets. It fronted on the North River, affording a beautiful view up the Hudson. Starting as the Bowling Green garden, it changed to Vauxhall in 1750.

Ranelagh was on Broadway, between Duane and Worth Streets, on the site where later the New York Hospital was erected. From advertisements of the period (1765-

69) we learn that there were band concerts twice a week at Ranelagh. The gardens were "for breakfasting as well as the evening entertainment of ladies and gentlemen." There was a commodious hall in the garden for dancing. Ranelagh lasted twenty years. Coffee, tea, and hot rolls could be had in the pleasure gardens at any hour of the day. Fireworks were featured at both Ranelagh and Vauxhall gardens. The second Vauxhall was near the intersection of the present Mulberry and Grand Streets, in 1798; the third was on Bowery Road, near Astor Place, in 1803. The Astor library was built upon its site in 1853.

William Niblo, previously proprietor of the Bank coffee house in Pine Street, opened, in 1828, a pleasure garden, that he named Sans Souci, on the site of a circus building called the Stadium at Broadway and Prince Street. In the center of the garden remained the stadium, which was devoted to theatrical performances of "a gay and attractive character." Later, he built a more pretentious theater that fronted on Broadway. The interior of the garden was "spacious, and adorned with shrubbery and walks, lighted with festoons of lamps." It was generally known as Niblo's garden.

Among other well known pleasure gardens of old New York were Contoit's, later the New York garden, and Cherry gardens, on old Cherry Hill.



TAVERN AND GROCERS' SIGNS USED IN OLD NEW YORK

*Left*, Smith Richards, grocer and confectioner, "at the sign of the tea canister and two sugar loaves" (1773); *center*, the King's Arms, originally Burns coffee house (1767); *right*, George Webster, Grocer, "at the sign of the three sugar loaves."

## CHAPTER XIII

### COFFEE HOUSES OF OLD PHILADELPHIA

YE COFFEE HOUSE, PHILADELPHIA'S FIRST COFFEE HOUSE, OPENED ABOUT 1700—  
THE TWO LONDON COFFEE HOUSES—THE CITY TAVERN, OR MERCHANTS COFFEE  
HOUSE—HOW THESE, AND OTHER CELEBRATED RESORTS, DOMINATED THE SOCIAL,  
POLITICAL, AND BUSINESS LIFE OF THE QUAKER CITY IN THE EIGHTEENTH CENTURY

WILLIAM PENN is generally credited with the introduction of coffee into the Quaker colony which he founded on the Delaware in 1682. He also brought to the "city of brotherly love" that other great drink of human brotherhood, tea. At first (1700), "like tea, coffee was only a drink for the well-to-do, except in sips."<sup>1</sup> As was the case in the other English colonies, coffee languished for a time while tea rose in favor, more especially in the home.

Following the Stamp Act of 1765, and the tea tax of 1767, the Pennsylvania Colony joined hands with the others in a general tea boycott; and coffee received the same impetus as elsewhere in the colonies that became the thirteen original states.

The coffee houses of early Philadelphia loom large in the history of the city and the republic. Picturesque in themselves, with their distinctive colonial architecture, their associations also were romantic. Many a civic, sociological, and industrial reform came into existence in the low-ceilinged, sanded-floor main rooms of the city's early coffee houses.

For many years, Ye Coffee House, the two London coffee houses, and the City tavern, also known as the Merchants coffee house, each in its turn dominated the official and social life of Philadelphia. The earlier houses were the regular meeting places of Quaker municipal officers, ship captains, and merchants who came to transact public and private business. As the

outbreak of the Revolution drew near, fiery colonials, many in Quaker garb, congregated there to argue against British oppression of the colonies. After the Revolution, the leading citizens resorted to the coffee house to dine and sup and to hold their social functions.

When the city was founded in 1682, coffee cost too much to admit of its being retailed to the general public at coffee houses. William Penn wrote in his *Accounts* that in 1683 coffee in the berry was sometimes procured in New York at a cost of eighteen shillings nine pence the pound, equal to about \$4.68. He told also that meals were served in the ordinaries at six pence (equal to twelve cents), to wit: "We have seven ordinaries for the entertainment of strangers and for workmen that are not housekeepers, and a good meal is to be had there for six pence sterling." With green coffee costing \$4.68 a pound, making the price of a cup about seventeen cents, it is not likely that coffee was on the menus of the ordinaries serving meals at twelve cents each. Ale was the common meal-time beverage.

There were four classes of public houses—inns, taverns, ordinaries, and coffee houses. The inn was a modest hotel that supplied lodgings, food, and drink, the beverages consisting mostly of ale, port, Jamaica rum, and Madeira wine. The tavern, though accommodating guests with bed and board, was more of a drinking place than a lodging house. The ordinary combined the characteristics of a restaurant and a boarding house. The coffee house was a preten-

<sup>1</sup> Oberholtzer, Ellis Paxson. *Philadelphia; a history of the city and its people*. Philadelphia, 1912. Vol. 1: p. 106.



tious tavern, dispensing, in most cases, intoxicating drinks as well as coffee.

#### *Philadelphia's First Coffee House*

The first house of public resort opened in Philadelphia bore the name of the Blue Anchor tavern, and was probably established in 1683 or 1684; colonial records do not state definitely. As its name indicates, this was a tavern. The first coffee house came into existence about the year 1700. Watson, in one place in his *Annals* of the city, says 1700, but in another 1702. The earlier date is thought to be correct, and is seemingly substantiated by the co-authors Scharf and Westcott in their *History* of the city, in which they say, "The first public house designated as a coffee house was built in Penn's time [1682-1701] by Samuel Carpenter, on the east side of Front Street, probably above Walnut Street. That it was the first of its kind—the only one in fact for some years—seems to be established beyond doubt. It was always referred to in old times as 'Ye Coffee House.'"<sup>2</sup>

Carpenter owned also the Globe inn, which was separated from the coffee house by a public stairway running down from Front Street to Water Street, and, it is supposed, to Carpenter's Wharf. The exact location of the old house was recently established from the title to the original patentee, Samuel Carpenter, by a Philadelphia real-estate title-guarantee company, as being between Walnut and Chestnut Streets, and occupying six and a half feet of what is now No. 137 South Front Street and the whole of No. 139.

How long the coffee house endured is uncertain. It was last mentioned in colonial records in a real estate conveyance from Carpenter to Samuel Finney, dated April 26, 1703. In that document it is described as "That brick Messuage, or Tenement, called Ye Coffee House, in the possession of Henry Flower, and situate, lying and being upon or before the bank of the Delaware River, containing in length about thirty feet and in breadth about twenty-four."

Henry Flower was postmaster for a number of years, and it is believed that the coffee house also did duty as post-office.

<sup>2</sup> Ye "being the archaic form of the definite article, pronounced "the."

Benjamin Franklin's *Pennsylvania Gazette*, in an issue published in 1734, has this advertisement:

All persons who are indebted to Henry Flower, late postmaster of Pennsylvania, for Postage of Letters or otherwise, are desir'd to pay the same to him at the old Coffee House in Philadelphia.

Flower's advertisement would indicate that the coffee house, then venerable enough to be designated as old, was still in existence, and that Flower was to be found there. Franklin also seems to have been in the coffee business, for in several issues of the *Gazette* around the year 1740 he advertised: "Very good coffee sold by the Printer."

#### *The First London Coffee House*

Philadelphia's second coffee house bore the name of the London coffee house, which title was later used for the resort William Bradford opened in 1754. The first house of this name was built in 1702, but there seems to be some doubt about its location. Writing in the *American Historical Register*, Charles H. Browning says: "William Rodney came to Philadelphia with Penn in 1682, and resided in Kent County, where he died in 1708; he built the old London coffee house at Front and Market Streets in 1702." Another chronicler gives its location as "above Walnut Street, either on the east side of Water Street, or on Delaware Avenue, or, as the streets are very close together, it may have been on both. John Shewbert, its proprietor, was a parishioner of Christ Church, and his establishment was largely patronized by Church of England people." It was also the gathering place of the followers of Penn and the Proprietary party, while their opponents, the political cohorts of Colonel Quarry, frequented Ye coffee house.

The first London coffee house resembled a fashionable club house in its later years, suitable for the "genteel" entertainments of the well-to-do Philadelphians. Ye Coffee House was more of a commercial or public exchange. Evidence of the gentility of the London is given by John William Wallace:

The appointments of the London coffee house, if we may infer what they were from the will of Mrs. Shubert [Shewbert] dated November 27, 1751, were genteel. By that instrument she makes bequest of two silver quart tankards; a silver cup; a silver porringer; a silver pepper



THE SECOND LONDON COFFEE HOUSE, OPENED IN 1754 BY WILLIAM BRADFORD, THE PRINTER

Up to the outbreak of the American Revolution, it was more frequented than any other tavern in the Quaker city as a place of resort and entertainment, and was famous throughout the colonies.

pot; two sets of silver castors; a silver soup spoon; a silver sauce spoon, and numerous silver tablespoons and tea spoons, with a silver teapot.

One of the many historic incidents connected with this old house was the visit there by William Penn's eldest son, John, in 1733, when he entertained the General Assembly of the province on one day and on the next feasted the City Corporation.

#### *Roberts' Coffee House*

Another house with some fame in the middle of the eighteenth century was Roberts' coffee house, which stood in Front Street near the first London house. Though its opening date is unknown, it is believed to have come into existence about 1740. In 1744 a British army officer recruiting troops for service in Jamaica advertised in the newspaper of the day that he could be seen at the Widow Roberts' coffee house. During the French and Indian War, when Philadelphia was in grave danger of attack by French and Spanish privateers, the citizens felt so great relief when the British ship Otter came to the rescue, that they proposed a public banquet in honor of the Otter's captain to be held at Roberts' cof-

fee house. For some unrecorded reason the entertainment was not given; probably because the house was too small to accommodate all the citizens desiring to attend. Widow Roberts retired in 1754.

#### *The James Coffee House*

Contemporary with Roberts' coffee house was the resort run first by Widow James, and later by her son, James James. It was established in 1744, and occupied a large wooden building on the northwest corner of Front and Walnut Streets. It was patronized by Governor Thomas and many of his political followers, and its name frequently appeared in the news and advertising columns of the *Pennsylvania Gazette*.

#### *The Second London Coffee House*

Probably the most celebrated coffee house in Penn's city was the one established by William Bradford, printer of the *Pennsylvania Journal*. It was on the southwest corner of Second and Market Streets, and was named the London coffee house, the second house in Philadelphia to bear that title. The building had stood since 1702,

when Charles Reed, later mayor of the city, put it up on land which he bought from Letitia Penn, daughter of William Penn, the founder. Bradford was the first to use the structure for coffee-house purposes, and he tells his reason for entering upon the business in his petition to the governor for a license: "Having been advised to keep a Coffee House for the benefit of merchants and traders, and as some people may at times be desirous to be furnished with other liquors besides coffee, your petitioner apprehends it is necessary to have the Governor's license." This would indicate that coffee was drunk as a refreshment between meals, as were spiritous liquors for so many years before and after, up to 1920.



SELLING SLAVES AT THE OLD LONDON COFFEE HOUSE IN PHILADELPHIA

Bradford's London coffee house seems to have been a joint-stock enterprise, for in his *Journal* of April 11, 1754, appeared this notice: "Subscribers to a public coffee house are invited to meet at the Court-house on Friday, the 19th instant, at 3 o'clock, to choose trustees agreeably to the plan of subscription."

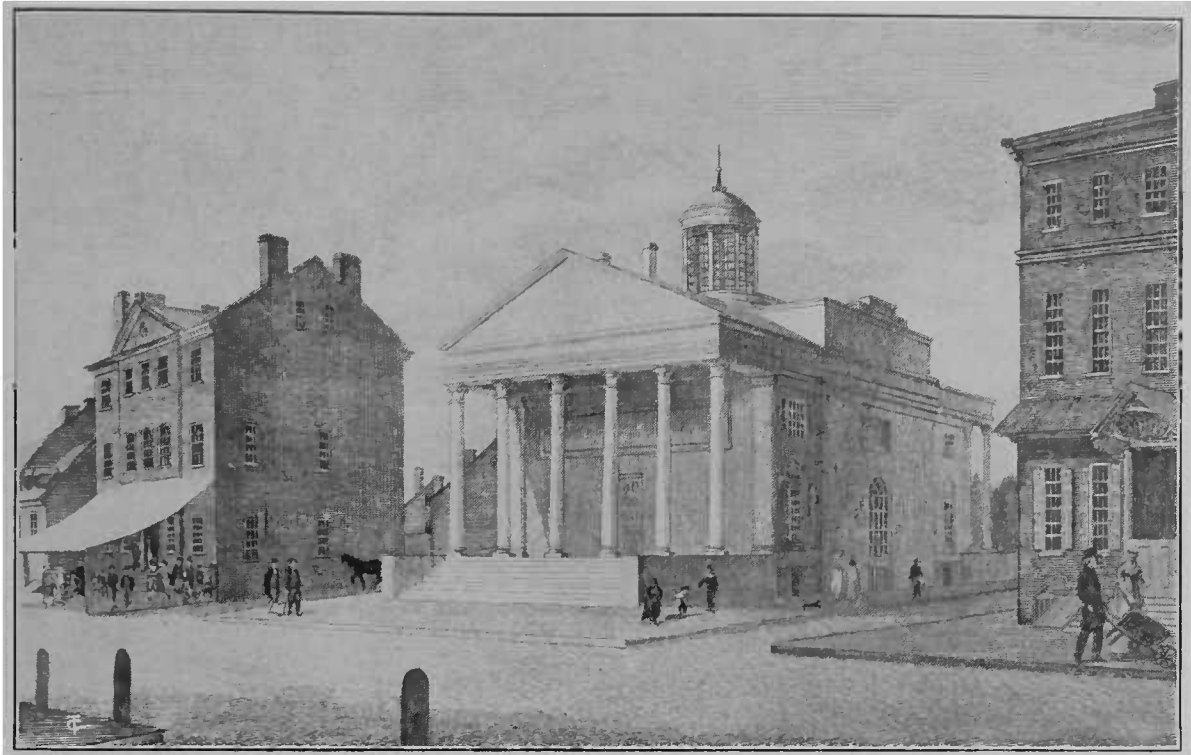
The building was a three-story wooden structure, with an attic that some historians count as the fourth story. There was a wooden awning one-story high extending out to cover the sidewalk before the coffee house. The entrance was on Market (then known as High) Street.

The London coffee house was "the pulsating heart of excitement, enterprise, and patriotism" of the early city. The most active citizens congregated there—merchants, shipmasters, travelers from other colonies and countries, crown and provincial officers. The governor and persons of equal note went there at certain hours "to sip their coffee from the hissing urn, and some of those stately visitors had their own stalls." It had also the character of a mercantile exchange—carriages, horses, foodstuffs, and the like being sold there at auction. It is further related that the early slave-holding Philadelphians sold negro men, women and children at vendue, exhibiting the slaves on a platform set up in the street before the coffee house.

The resort was the barometer of public sentiment. It was in the street before this house that a newspaper published in Barbados, bearing a stamp in accordance with the provisions of the Stamp Act, was publicly burned in 1765, amid the cheers of bystanders. It was here that Captain Wise of the brig *Minerva*, from Pool, England, who brought news of the repeal of the act, was enthusiastically greeted by the crowd in May, 1766. Here, too, for several years the fishermen set up May poles.

Bradford gave up the coffee house when he joined the newly formed Revolutionary army as major, later becoming a colonel. When the British entered the city in September, 1777, the officers resorted to the London coffee house, which was much frequented by Tory sympathizers. After the British had evacuated the city, Colonel Bradford resumed proprietorship; but he found a change in the public's attitude toward the old resort, and thereafter its fortunes began to decline, probably hastened by the keen competition offered by the City tavern, which had been opened a few years before.

Bradford gave up the lease in 1780, transferring the property to John Pemberton, who leased it to Gifford Dally. Pemberton was a Friend, and his scruples about gambling and other sins are well exhibited in the terms of the lease in which said Dally "covenants and agrees and promises that he will exert his endeavors as a Christian to preserve decency and order in said house, and to discourage the profanation of the sacred name of God Almighty by cursing, swearing, etc., and that the house on the first day of the week shall always be



THE CITY TAVERN, BUILT IN 1773, AND KNOWN AS THE MERCHANTS COFFEE HOUSE

The tavern, at the left, was regarded as the largest inn of the colonies and stood next to the Bank of Pennsylvania (center). (From a print made from a rare Birch engraving.)

kept closed from public use." It is further covenanted that "under a penalty of £100 he will not allow or suffer any person to use, or play at, or divert themselves with cards, dice, back-gammon, or any other unlawful game."

It would seem from the terms of the lease that what Pemberton thought were ungodly things, were countenanced in other coffee houses of the day. Perhaps the regulations were too strict; for a few years later the house passed into the hands of John Stokes, who used it as dwelling and a store.

#### *City Tavern or Merchants Coffee House*

The last of the celebrated coffee houses in Philadelphia was built in 1773 under the name of the City tavern, which later became known as the Merchants coffee house, possibly after the house of the same name that was then famous in New York. It stood in Second Street near Walnut Street, and in some respects was even more noted than Bradford's London coffee house, with which it had to compete in its early days.

The City tavern was patterned after the

best London coffee houses; and when opened, it was looked upon as the finest and largest of its kind in America. It was three stories high, built of brick, and had several large club rooms, two of which were connected by a wide doorway that, when open, made a large dining room fifty feet long.

Daniel Smith was the first proprietor, and he opened it to the public early in 1774. Before the Revolution, Smith had a hard struggle trying to win patronage from Bradford's London coffee house, standing only a few blocks away. But during and after the war, the City tavern gradually took the lead, and for more than a quarter of a century was the principal gathering place of the city. At first, the house had various names in the public mind, some calling it by its proper title, the City tavern, others attaching the name of the proprietor and designating it as Smith's tavern, while still others called it the New tavern.

The gentlefolk of the city resorted to the City tavern after the Revolution as they had to Bradford's coffee house before. However, before reaching this high estate, it once was near destruction at the hands

of the Tories, who threatened to tear it down. That was when it was proposed to hold a banquet there in honor of Mrs. George Washington, who had stopped in the city in 1776 while on the way to meet her distinguished husband, then at Cambridge in Massachusetts, taking over command of the American army. Trouble was averted by Mrs. Washington tactfully declining to appear at the tavern.

After peace came, the house was the scene of many of the fashionable entertainments of the period. Here met the City Dancing Assembly, and here was held the brilliant fête given by M. Gerard, first accredited representative from France to the United States, in honor of Louis XVI's birthday. Washington, Jefferson, Hamilton, and other leaders of public thought were more or less frequent visitors when in Philadelphia.

The exact date when the City tavern became the Merchants coffee house is unknown. When James Kitchen became pro-

prietor, at the beginning of the nineteenth century, it was so called. In 1806 Kitchen turned the house into a bourse, or mercantile exchange. By that time clubs and hotels had come into fashion, and the coffee-house idea was losing caste with the élite of the city.

In the year 1806, William Renshaw planned to open the Exchange coffee house in the Bingham mansion on Third Street. He even solicited subscriptions to the enterprise, saying that he proposed to keep a marine diary and a registry of vessels for sale, to receive and to forward ships' letter bags, and to have accommodations for holding auctions. But he was persuaded from the idea, partly by the fact that the Merchants coffee house seemed to be satisfactorily filling that particular niche in the city life, and partly because the hotel business offered better inducements. He abandoned the plan, and opened the Mansion House hotel in the Bingham residence in 1807.



EXCHANGE COFFEE HOUSE SCENE IN "HAMILTON"

In this setting for the first act of the play by Mary P. Hamlin and George Arliss, produced in 1918, the scenic artist aimed to give a true historical background, and combined the features of several inns and coffee houses in Philadelphia, Virginia, and New England as they existed in Washington's first administration.



**BOOK II**  
**TECHNICAL ASPECTS**



## CHAPTER XIV

### THE COMMERCIAL COFFEES OF THE WORLD

A BRIEF SURVEY OF THE COFFEES OF COMMERCE—GENERAL CLASSIFICATION AS “BRAZILS” AND “MILDS”—WHERE THEY COME FROM AND HOW THEY ARE DESIGNATED—THE LEADING COFFEE PRODUCING COUNTRIES—CHARACTERISTICS OF THE COFFEES OF BRAZIL, COLOMBIA, NETHERLANDS INDIES, VENEZUELA, EL SALVADOR, GUATEMALA, MEXICO, SOUTHERN INDIA, HAITI, COSTA RICA, NICARAGUA, ARABIA, AND KENYA—COMMERCIAL COFFEE CHART SHOWING THE LEADING GROWTHS, THEIR MARKET NAMES, AND GENERAL TRADE CHARACTERISTICS

THE commercial coffees of the world are grown in semi-tropical countries at altitudes from sea level to 6,000 feet; the best grades being grown at considerable elevation, while coffee grown at low altitude is likely to be of little cup value.

There are two general classifications, “Brazilis” and “Milds.” A little more than two-thirds of the world’s supply comes from Brazil, while the milds, produced in other countries, make up the other third.

Among the leading coffee producing countries are: Abyssinia, Arabia, Brazil, Colombia, Costa Rica, Guatemala, Haiti, Hawaii, Kenya, Jamaica, Java, Madagascar, Mexico, Nicaragua, Philippine Islands, Puerto Rico, El Salvador, Santo Domingo, Southern India, Sumatra, and Venezuela.

BRAZIL coffees produced in districts tributary to the ports of Santos and Rio de Janeiro, are given the general designation of “Santos” or “Rio” coffees. Other shipping ports are Angra dos Reis, Victoria, Bahia, Paranagua, and Recife.

Brazilis are sometimes referred to by the names of the states in which they are produced. The principal ones are: São Paulo, Minas Geraes, Rio de Janeiro, Espírito Santo, Bahia, Pernambuco, Paraná, Goyaz, Ceará, Parahyba, Santa Catharina, Alagoas, Sergipe, and Matto Grosso.

COLOMBIA coffees are rich and mild in the cup, the fancy grades comparing favorably with the world’s best growths. They are said to produce 25 per cent more liquor of a given strength than Santos coffees, and possess finer flavor and aroma. The best-known are “Medellins,” “Manizales,” “Bogotas,” “Bucaramangas,” “Tolimas,” “Cucutas,” “Armenias,” “Girardots,” and “Hondas.”

Colombias have become standard for blending in the United States because of their availability, regularity, and flavor.

THE NETHERLANDS INDIES. For many years the world’s markets knew all coffees from the islands of the N. I.—Java, Sumatra, Timor, Boengie, etc.—as “Javas”; but since the passage of the Pure Food laws in the United States it has been ruled that only *Coffea arabica* grown in the island of Java may be sold under that name. *Coffea robusta*, a hardier but vastly inferior type, even though grown in the island, must be sold under its own name, as Robusta.

The finest N. I. coffees are produced in the districts of Mandheling and Ankola in Sumatra, at an elevation of 3,000 feet. The ports are Medan on the East Coast, Padang and Sibolga, on the West Coast, and Palembang and Telok-Betong, on the Southeast Coast.

Java coffee districts include such well-known names as Buitenzorg, Preanger, Cheribon, Kadoe, Semarang, and Malang. The shipping port is Batavia.

VENEZUELA coffees are known by such trade names as “Maracaibo,” “Caracas,”

“Puerto Cabello,” “Mérida,” “Cucutá,” “Tovar,” “Trujillo,” and “Tachira.” The principal points of export are Maracaibo, La Guaira (seaport for Caracas), and Puerto Cabello. Europe gets the bulk of the exportations.

Maracaibo is the port of shipment for all coffees from western Venezuela, and the Cucutá coffees from Colombia. Maracaibo coffee, familiarly known to the trade as “Mara,” has a large, well-ripened bean of green or yellowish-green color, agreeable cup, and pleasing aroma. It is used for blending with coffees from Colombia and Brazil, among others. New-crop Mara’s are probably the most treacherous in the cup of any coffees produced, but fancy old-crop Maras are very highly esteemed and are sometimes used in place of high-grade Indias.

Caracas beans are bluish-green and are well prepared. They have an aromatic, slightly acid taste, and are used for blending. They are not popular in the U. S. A. because they lack body.

Puerto Cabello coffee is similar to that from Caracas, though not as well prepared, and consequently not its equal in aroma. A large part of the Puerto Cabello coffees are “naturals.”

EL SALVADOR coffees have a smooth, green bean and neutral flavor. The exports are divided between Europe and the United States, and are differentiated as “washed” and “unwashed,” according to the process of their preparation.

GUATEMALA coffees are waxy, bluish beans with mellow flavor, and are shipped mostly to European markets. In roasting, the beans split open and show white centers. They command good prices, but are usually not heavy in body and popular mostly because of their flavor and style. The shipping ports are Puerto Barrios and Champerico.

MEXICO’S coffees are produced under conditions of production which vary so greatly that they are comparable to all coffees from Rios to Sumatras. The best grades are grown at altitudes from 3,000 to 4,500 feet, and in addition to acidity, possess a richness and aroma which places them among the world’s best growths. Coffee-district names include Coatepec (Co-at’-e-pec), Jalapa (Ha-lah-pa), Huatusco (Wha-toos’-co), Oaxaca (Wa-hoc’-kah), Tapachula, Cordoba, and Orizaba. Exports are divided about equally between the

United States and Europe. The shipping seaports are Vera Cruz and Salina Cruz.

SOUTHERN INDIA’S best and highest priced coffees come from the Nilgiri hills in the province of Madras. They are noted for their blue color, cleanness of bean, and fine liquoring qualities. These coffees are closely followed by “Shevaroy,” “Anamalai,” and “Kanan Devan.” Then come the Coorg and Mysore coffees, about equal to each other in quality, but Mysore accounts for more than half of the Southern India exports and has favored zones which produce coffees almost equal in quality to Nilgiri. The shipping ports are Madras on the east coast and Calicut on the West.

HAWAII produces a mild coffee which is greatly prized by the coffee consumers in Continental Europe, and particularly in France. The bean is blue-green, and turns out well in the roast. It is used to improve the ordinary kinds from other countries. Cape Hatien is the shipping port.

COSTA RICA produces some of the finest coffees known to the trade. Being of heavy body and sharply acid, they are best adapted for blending. The fancy growths go to London and the Continent of Europe. The shipping ports are Puerto Limon and Puntarenas.

NICARAGUA produces “washed” coffees of merit, but the “naturals,” comprising the bulk of the crops are of ordinary quality and “Rio-y” flavor. Corinto on the Pacific, is the shipping port.

ARABIA is the home of Mocha coffee, considered for many generations as the world’s best coffee. The beans are very small, hard, roundish, and irregular in form and size; they are acid in character and the cup flavor is smooth and delicious.

KENYA coffees, from East Africa, have made rapid progress in United Kingdom and United States markets in the last twenty years. They are prepared in some fourteen districts by the “washed,” or fermented, process, and are solely of the *arabica* variety. A characteristic of Kenya coffee is the presence of a portion of the silver skin adherent to the bean. However, the presence of this silver skin detracts only from the appearance of the coffee, and not from its cup quality.

OTHER COFFEES of less importance to the general reader, but of equal interest to the trade, are described in Chapter XIX, or in the Complete Reference Table at the end of that chapter.

## COMMERCIAL COFFEE CHART

*The World's Leading Growths, with Market Names and General Trade Characteristics*

<i>Grand Division</i>	<i>Country</i>	<i>Principal Shipping Ports</i>	<i>Best Known Market Names</i>	<i>Trade Characteristics</i>
North America	Mexico	Vera Cruz Salina Cruz	Coatepec Jalapa Huatusco Oaxaca Tapachula Cordoba Orizaba	Greenish to yellow bean; mild flavor.
Central America	Guatemala	Puerto Barrios Champerico	Guatemala	Waxy, bluish bean; mellow flavor.
	Salvador	La Libertad	Salvador	Smooth, green bean; neu- tral flavor.
	Costa Rica	Puerto Limon Puntarenas	Costa Rica	Blue-greenish bean; mild flavor.
	Nicaragua	Corinto	Nicaragua	Waxy bean, deficient in body and flavor.
West Indies	Haiti	Cape Haitien	Haiti	Blue bean; rich, fairly acid; sweet flavor.
	Santo Domingo	Santo Domingo	Santo Domingo	Flat, greenish-yellow bean; strong flavor.
	Jamaica	Kingston	Blue Mountain	Bluish-green bean; rich, full flavor.
	Puerto Rico	Ponce	Porto Ricans	Gray-blue bean; strong, heavy flavor.
South America	Colombia	Barranquilla Buenaventura Cartagena	Medellin, Armenia Manizales, Bogota Bucaramanga	Greenish bean; rich mellow flavor.
	Venezuela	Maracaibo La Guaira Puerto Cabello	Merida, Tovar Cucuta, Tachira Caracas, Trujillo	Greenish and yellowish bean; mild mellow flavor.
	Brazil	Santos  Rio de Janeiro	Santos  Rio	Medium to large bean; mild flavor. Medium to large bean; strong cup.
Asia	Arabia	Aden	Mocha	Small, short, green to yel- low bean; unique, mild flavor.
	Southern India	Madras Calicut	Mysore Madras Coorg	Small to large blue-green bean; strong flavor.
East India Islands	Sumatra	Medan Padang Sibolga  Palembang Telok-Betong	Mandheling Ankola  Robusta	Large, yellow to brown bean; heavy body; ex- quisite flavor. Small, yellowish-green round bean. Thin cup.
	Java	Batavia	Buitenzorg Preanger Cheribon	Small, blue to yellow bean; light in cup.
Africa	Abyssinia	Jibuti	Harar Abyssinia	Large, blue to yellow bean; very like Mocha.
	Kenya	Mombassa	Kenya	Mysore characteristics: acid, mild flavor, full bodied.
Pacific Islands	Hawaiian Islands Philippines	Honolulu Manila	Kona Hamakua Manila	Large, blue, flinty bean; mildly acid. Yellow and brown large bean; mild cup.





GENERAL VIEW OF A COFFEE FAZENDA IN THE STATE OF SÃO PAULO, BRAZIL

## CHAPTER XV

### CULTIVATION AND PREPARATION OF COFFEE

COFFEE CULTIVATION PAST AND PRESENT—GENERAL REQUIREMENTS—SOIL, CLIMATE, ALTITUDE, PROPAGATION, PREPARING THE PLANTATION, FERTILIZING, PRUNING, CATCH CROPS, PESTS AND DISEASES, AND PICKING—PREPARATION FOR THE MARKET—THE DRY OR “NATURAL” PROCESS—THE WET OR “WASHED COFFEE” METHOD—PULPING, FERMENTING, WASHING, AND DRYING—THE FINAL STEPS IN THE PREPARATION OF COFFEE—HULLING AND POLISHING—SIZING AND GRADING FOR THE MARKET

FOR the beginnings of coffee culture we must go back to the Arabian colony of Harar in Abyssinia. Here, about the fifteenth century, the Arabs, having found the plant growing wild in the Abyssinian highlands, first gave it intensive cultivation. The complete story of the early cultivation of coffee in the old and new worlds is told in chapter I, which deals with the history of the propagation of the coffee plant.

La Roque<sup>1</sup> was the first to tell how the plant was cultivated and the berries prepared for market in Arabia, where it was brought from Abyssinia.

The Arabs raised it from seed grown in nurseries, transplanting it to plantations laid out in the foot-hills of the mountains, to which they conducted the mountain streams by ingeniously constructed small channels to water the roots. They built trenches three feet wide and five feet deep, lining them with pebbles to cause the water to sink deep into the earth with which the trenches were filled, to preserve the moisture from too rapid evaporation. These were so constructed that the water could be turned off into other channels when the fruit began to ripen. In plantations exposed to the south, a kind of poplar tree was planted along the trenches to supply needful shade.

La Roque noted that the coffee trees in Yemen were planted in lines, like the apple

trees in Normandy; and that when they were much exposed to the sun, the shade poplars were regularly introduced between the rows.

Such cultivation as the plant received in early Abyssinia and Arabia was crude and primitive at best. Throughout the intervening centuries, there has been little improvement in Yemen; but modern cultural methods obtain in the Harar district in Abyssinia (now Ethiopia).

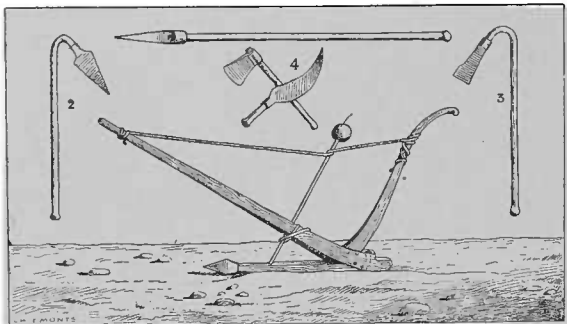
Like the Arabs in Yemen, the Harari cultivated coffee in small gardens, employing the same ingenious system of irrigation from mountain springs to water the roots of the plants at least once a week during the dry season. In Yemen and in Abyssinia the ripened berries were sundried on beaten-earth barbecues.

The European planters who carried the cultivation of the bean to the Far East and to America followed the best Arabian practice, changing, and sometimes improving it, in order to adapt it to local conditions.

#### *Coffee Cultivation in General*

Today the commercial growers of coffee on a large scale practise intensive cultivation methods, giving the same care to preparing their plantations and maintaining their trees as do other growers of grains and fruits. As in the more advanced methods of arboriculture, every effort is made to obtain the maximum production of quality coffee consistent with the small-

<sup>1</sup>La Roque, Jean. *Voyage de l'Arabie Heureuse*, Paris, 1715, p. 280.



IMPLEMENTS USED IN EARLY ARABIAN COFFEE CULTURE

1, Plow. 2 and 3, Mattocks. 4, Hatchet and sickle. 5, Top, Seeder implement.

est outlay of money and labor. Experimental stations in various parts of the world are constantly working to improve methods and products, and to develop types that will resist disease and adverse climatic conditions.

While cultivation methods in the different producing countries vary in detail of practice, the principles are unchanging. Where methods differ, it is owing principally to local economic conditions, such as the supply and cost of labor, machinery, fertilizers, and similar essential factors.

#### General Requirements

**SOIL.** Coffee grows best on ground composed of disintegrated volcanic rock with a rich mixture of decomposed mold. In tropical Africa, the natural habitat of the coffee tree, the soil is rich, moist, and sufficiently friable to furnish well-drained seed beds. These conditions must be approximated when the tree is grown in other countries. Brazil's most famous coffee soil is known as *terra roxa*, a top-soil of red clay three or four feet thick with a gravelly subsoil. In Java, most of the estates observed by the author consist of rolling

ground, possessing a loamy soil overlying porous subsoil or else rocky soils with pockets of rich soil. They are well drained, cool, and the rocks form an inexhaustible reserve of food for the trees.

In order to make sure that a soil is right for coffee growth, the presence of tall, straight trees is usually accepted as indicating a deep, rich soil with an ample water supply.

**CLIMATE.** Generally speaking, a temperate climate within the tropics is the most suitable for coffee-growing; however, it has been successfully cultivated between latitudes 28° north and 38° south.

Because coffee trees cannot withstand frost, their cultivation is restricted to regions where the mean annual temperature is about 70° F., with an average minimum not lower than 55° and an average maximum of about 80°. Where coffee is grown in regions subject to more or less frost, as in parts of southern Brazil, Mexico, and other countries which lie almost within the two temperate zones, the trees and fruit are sometimes frosted without permanent detrimental effect to the trees, unless it is a killing frost. An instance of the kind occurred in 1918, when about 40 per cent of the São Paulo crop and trees were affected.

Although coffee can be grown satisfactorily only on well-drained land, the tree requires an abundance of water, say about 70 inches of rainfall annually, and equally distributed throughout the year. Prolonged droughts are fatal. On the other hand, too much water tends to develop the wood of the tree at the expense of the flowers and fruit, especially in low-lying regions.

**ALTITUDE.** Coffee grows at all altitudes from sea-level up to the frost level, which is about 6,000 feet in the tropics. The *robusta* and *liberica* varieties do best in



CROSS SECTION OF MOUNTAIN SLOPE IN YEMEN, ARABIA, SHOWING COFFEE TERRACES

These miniature plantations are found chiefly along the caravan route between Hodeida and Sanaa.



COFFEE NURSERY UNDER A BAMBOO ROOF IN COLOMBIA

regions from sea-level up to 3,000 feet, while *arabica* flourishes better at the higher altitudes.

The coffee plant needs sunshine, but a few hours daily exposure is sufficient. Hilly ground has the advantage of offering a suitable exposure, because the sun shines on it only a part of the day. Whether it is the early morning or the afternoon sun that enables the plant to attain its optimum conditions is a question of locality.

In Mexico, Romero tells us, the highlands of Soconusco have the advantage that the sun does not shine on the trees during the whole of the day. On the higher slopes of the Cordilleras—above 2,500 feet—clouds prevail during the summer season, when the sun is hottest, and are frequently present in the other seasons, after ten o'clock in the morning. They keep the trees from being exposed to the heat of the sun during the whole of the day. Perhaps to this circumstance is due the superior excellence of certain coffees grown in Mexico, Colombia, and Sumatra at altitudes of 3,000 to 4,000 feet.

Richard Spruce, the botanist, in his notes on South America, as quoted by Alfred Russell Wallace, refers to "a zone of the equatorial Andes ranging between 4,000

and 6,000 feet altitude, where the best flavored coffee is grown."<sup>2</sup>

**PROPAGATION.** Coffee trees usually are grown from seeds selected from trees of known productivity and longevity; although in some parts of the world propagation is from shoots or cuttings. The seed method is most general, however, the seeds being either propagated in nursery beds, or planted at once in the spot where the mature tree is to stand. In the latter case—called planting at stake—four or five seeds are planted, much as corn is sown; and after germination, all but the strongest plants are removed.

Seeds for sowing are selected from specially chosen bushes of about seven to eight years old, in full bearing. The largest fruit, situated in the middle of the branches, half way up the bush, is selected and allowed to become thoroughly ripe before being picked. Then the pulp is removed by hand, with care that the parchment is not broken. If the seeds are not to be used at once they are dried in the shade, to prevent their shrinking, and are packed in layers, with sand between, in wooden boxes. If stored in a cool place,

<sup>2</sup> *Encyclopedia Britannica*, 11 ed., Cambridge, 1910, vol. i, p. 118.





BRAZILIAN COFFEE PLANTATION

General view of a São Paulo *fazenda* showing planter's residence and drying grounds in the center, laborers' quarters in the foreground and coffee in the background.

shaded from the sun, they are sometimes kept for months in this way.

Where the nursery method is followed, the choicest land of the plantation is chosen for its site; and the seeds are planted about three inches apart and an inch and a half deep in seed beds. When the small plants are about eight inches high they are transplanted to the nursery, and planted about 12 inches apart. The nursery is so located that it has the shade of tall forest trees. The plants are about six months old when transplanted to the nursery, and about 18 months later, or two years from seed, they are planted in the permanent fields. This is the method generally followed in Central America. When the plants are to be transplanted direct to the plantation from the seed-bed the seeds are generally sown six inches apart in rows separated by the same distance.

During the six to seven weeks required for the coffee seed to germinate, the soil must be kept moist, shaded, and thoroughly weeded. If the trees are to be grown without shade, the young plants are gradually exposed to the sun, to harden them, before they begin their existence in the plantation proper.

Considerable experimental work has been done in renewing trees by grafting, notably in Java; but practically all commercial planters follow the seed method.

**PREPARING THE PLANTATION.** Before transplanting time, the plantation is made ready to receive the young plants. Coffee plantations are generally laid out on heavily wooded and sloping lands, often

in forests on mountain-sides and plateaus, where there is an abundance of water, of which large quantities are used in cultivating the trees and in preparing the coffee beans for market. The ideal soil is one that contains a large proportion of potassium and phosphoric acid; and for that reason, the general practice is to burn off the foliage and trees covering the land and to use the ashes as fertilizer.

In preparing the soil for the new plantation under the intensive cultivation method, the surface of the land is lightly plowed, and this is followed by a thorough cultivation. The plants are set out in shallow holes at regular intervals of eight, twelve, or even fourteen, feet apart. This gives room for the root system to develop, provides space for sunlight to reach each tree, and makes for convenience in cultivating and harvesting. *Liberica* and *robusta* trees require more room than *arabica*.

When set twelve feet apart, with the same distance between rows, there are 300 trees to the acre. At 10 feet x 10 feet, there are 450 trees. In the triangle, or hexagon, system where the trees are planted in the form of an equilateral triangle, each tree being the same distance, usually eight or nine feet, from its six nearest neighbors, there are 600 to 800 trees per acre.

Coffee trees begin to bear when three to five years from seed. There may be two, three, or even more flushes of blossoms in a single year and thus it is common to see flowers and fruits in all stages of development on the same tree.

**SHADES AND WIND BREAKS.** Strong, chilly winds and intensely hot sunlight are



TRANSPLANTING COFFEE, GUATEMALA





COFFEE GROWING UNDER SHADE IN ANTIOQUIA, COLOMBIA

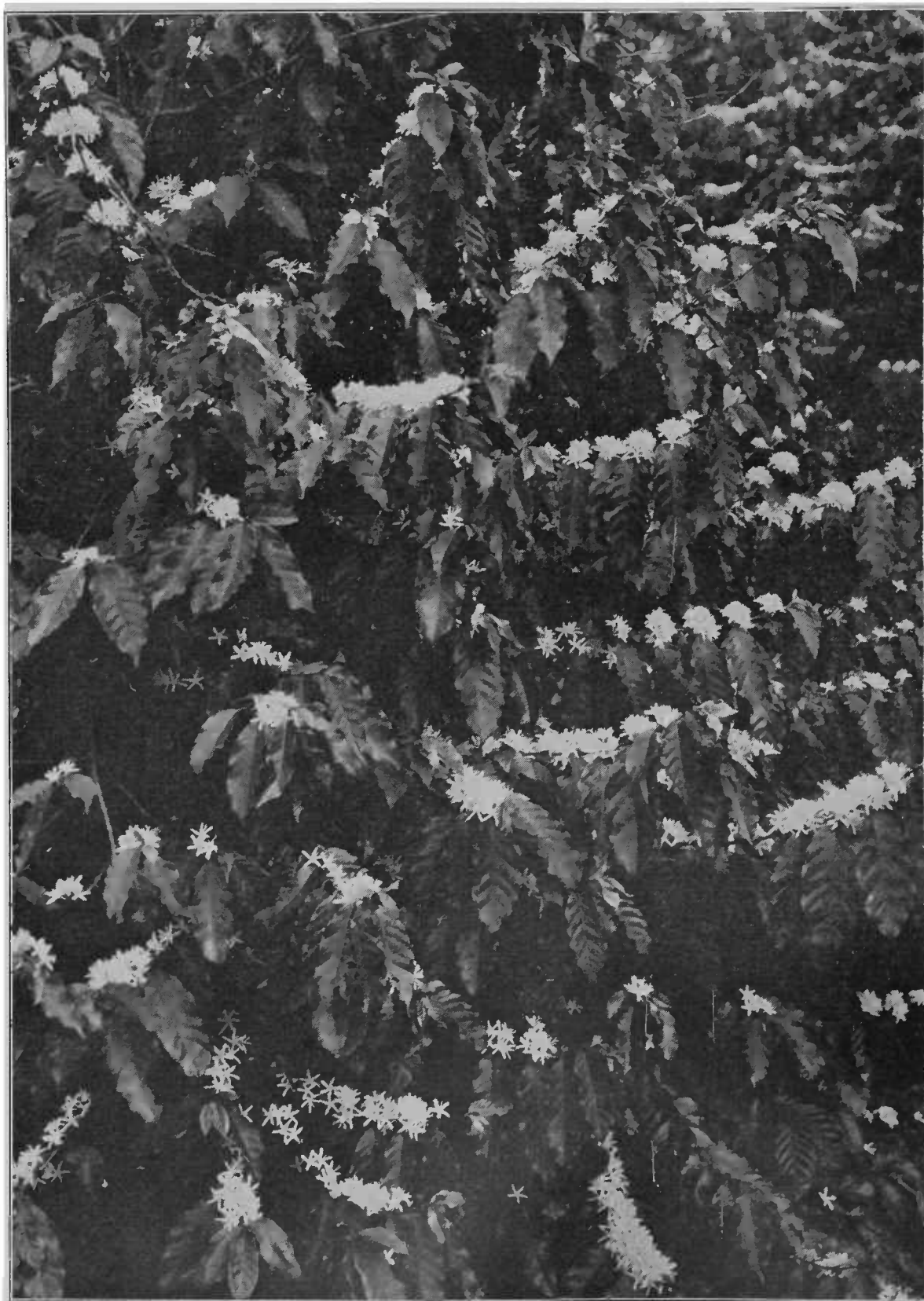
foes of coffee trees, especially the *arabica* variety. Accordingly, in most countries it is customary to protect the plantation with wind-breaks consisting of rugged trees, and to shade the coffee by growing trees of other kinds between the rows. The shade trees serve also to check soil erosion; and in the case of the leguminous kinds, furnish nutriment to the soil. Coffee does best in shade such as is afforded by the leguminous silver oak (*Grevillea robusta*). The subject is discussed extensively in *Shade in Coffee Culture*, Bulletin 25, 1901, Division of Botany, United States Department of Agriculture.

The methods employed in the care of a coffee plantation do not differ materially from those followed by advanced orchardists in the fruit-belts of the world. After the young plants have gained their start, they are cultivated frequently, principally to keep out the weeds, to destroy pests, and to aerate the earth. The implements used range from crude hand-plows to horse-drawn cultivators.

**FERTILIZING.** Comparatively little fertilizing is done on plantations established on virgin soil until the trees begin to bear. Because the coffee tree takes potash, nitro-

gen, and phosphoric acid from the soil, the usual scheme of fertilizing is to restore these elements. The materials used to replace the soil-constituents consist of stable manure, leguminous plants, coffee-tree prunings, leaves, certain weeds, oil cake, bone and fish meal, guano, wood ashes, coffee pulp, and such chemical fertilizers as superphosphate of lime, basic slag, sulphate of ammonia, nitrate of lime, sulphate of potash, nitrate of potash, and similar materials.

The kind of fertilizer used depends largely on scientific soil analysis and manuring experiments, where this service is available, as well as upon local climate and soil conditions, the supply, the cost, and other factors. Leguminous plants make the best fresh fertilizer, either grown as ground cover, to be dug into the soil, or in hedges, like *Leucaena glauca*, between the coffee rows. The chemical fertilizers are coming into increasing use in the larger and more advanced producing countries. Brazil, particularly, is showing a tendency toward their adoption to make up for the dwindling supply of the so-called natural manures. As the coffee tree grows older, it requires a larger supply of fertilizer.



MASSES OF BLOSSOMS ON A COFFEE TREE IN THE FLOWERING PERIOD



PRUNING A YOUNG COFFEE TREE, COLOMBIA

**PRUNING.** On the larger plantations, pruning is an important part of the cultivation processes. If left to their own devices, coffee trees sometimes grow as high as forty feet, the strength being absorbed by the wood, with a consequent scanty production of fruit. To prevent this undesirable result, and to facilitate picking, the trees on the more modern plantations are pruned down to heights ranging from five to twelve feet. Except for pruning the roots when transplanting, the tree is permitted to grow until after producing its first full crop before any cutting takes place. Then, the branches are severely cut back; and thereafter, pruning is carried on annually. Topping and pruning begin between the first and the second years. For example, in Java and Sumatra the operations are as follows:

*First*—Topping, by which the terminal shoots of the main stem, consisting of bud and pair of young leaves, are removed when the plant is between three to five feet high.

*Second*—The pruning proper, after the first crop has been harvested, when all secondary branches within five or six inches of the main stem are removed; also the shoots that have borne fruit, and any dead and diseased wood, branches that are growing toward the center of the tree or across other branches, and all tertiary branches. The secondary branches formed on primary branches bear fruit, but every alternate secondary branch is removed to insure the fruit being properly nourished. During the pruning the stems are cleared of moss and other extraneous growths in order to allow the air to get to the young bark and to destroy insects.

When planting in the permanent fields, no tree of less than two cruces is planted, and above the second cruce the tree is topped. This causes two main stems to grow in place of one. In another two

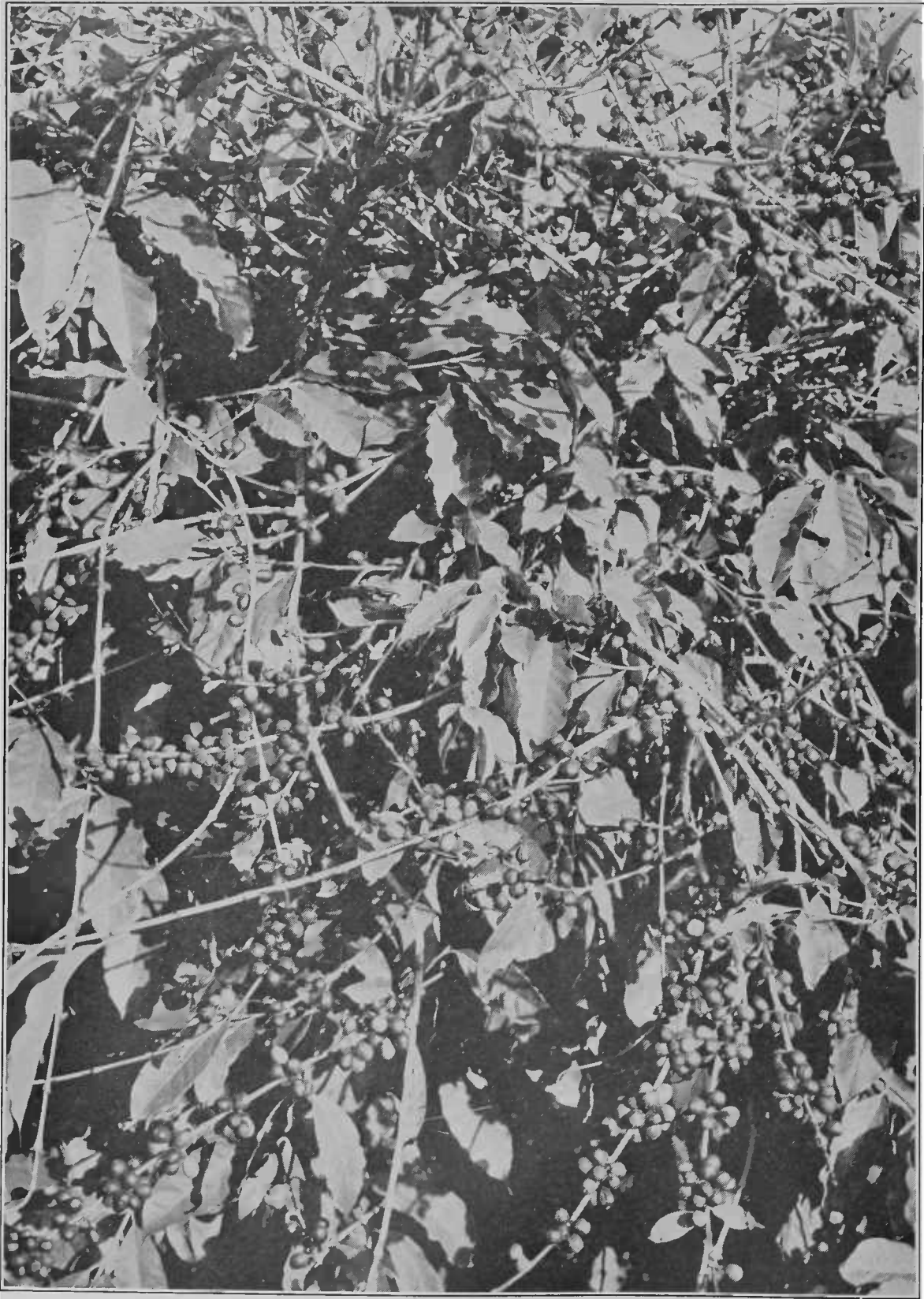
years these two main stems are topped, and this causes four main stems to grow instead of two. The coffee plant was intended by nature to be a tree, but in its perfected state as a fruit tree, it thus becomes a bush, increasing enormously its fruit bearing possibilities.

Coffee trees as a rule produce full crops up to the fifteenth year, although some trees have given a paying crop until twenty or thirty years old. Existing trees of over 100 years known age still bear coffee. Ordinarily the trees bear from one-half pound to eight pounds of coffee annually, although there are accounts of twelve pounds being obtained per tree. Two pounds of clean coffee per tree is considered a satisfactory production. Production is governed mainly by the cultivation given the tree, and by climate, soil, and location. When too old to bear profitable yields, the trees on commercial plantations are cut down to 12 inches above the ground; and are renewed by permitting only the two strongest sprouts springing out of the stump, to mature.

**CATCH CROPS.** On some plantations it is the practice to grow catch crops between the rows of coffee trees, both as a means of obtaining additional revenue and to shade



COFFEE TREE IN BLOSSOM, COSTA RICA

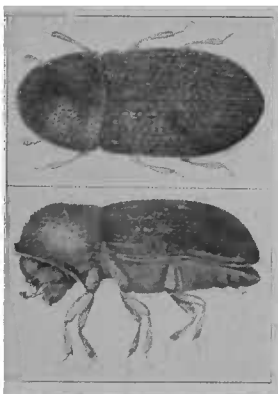


CLOSE-UP VIEW OF A COFFEE TREE IN BEARING



the young coffee plants. Corn, beans, cotton, peanuts, and similar plants are used.

**PESTS AND DISEASES.** The coffee tree, its wood, foliage, and fruit, have their enemies, chief among which are insects, fungi, coffee rats, birds, squirrels, and—according to Rossignon—elephants, buffalo, and native cattle, which have a special liking for the tender leaves of the coffee plant. Insects and fungi are the most bothersome pests on most plantations. Among the insects, the several varieties of borers are the principal foes, boring into the wood of the trunk and branches to lay *larvae* which sap the life from the tree. There are scale insects whose excretion forms a black mold on the leaves and affects the nutrition by cutting off the sunlight. Numerous kinds of beetles, caterpillars, grasshoppers, and crickets attack the coffee-tree leaves, the so-called "leaf-miner" being especially troublesome. The Mediterranean fruit fly deposits larvae which destroy or lessen the worth of the coffee berry by tunneling within and eating the contents of the parchment.



*Stephanoderes hempei*,  
Magnified 20 Diameters

The coffee-bean borer, identified as *Stephanoderes hempei*, Ferr., in Africa and Java, and as *Stephanoderes coffea*, Hagerdorn, in Brazil, is one of the worst coffee pests to combat, because the small beetles bearing this name lay their eggs in the coffee fruit and the larvae bore into and infest the coffee bean, where it is impossible to destroy them by any of the usual surface remedies, such as sprays, etc. The original home of the insect appears to have been Uganda, in the eastern part of Africa. About 1921 it appeared in Java, and had reached formidable proportions by the following year. Brazil has combatted the pest by isolating and stripping the trees in an infested zone of all fruit and blossoms, and then cleaning all ground litter and even knot-holes and crevices where infested cherries might have fallen. About 1925-26, in Uganda and Java, a wasp was developed which laid its eggs in and destroyed *Stephanoderes*, but the parasite

wasps could not be produced as rapidly as the bean-borers multiplied. In 1934, as a means of protection, the Public Works Department of Kenya, at Nairobi, introduced a plan of compulsory heat treatment for bagged coffee upon its arrival from infested areas, whereby the bags with their contents intact are given heat treatment in a drying kiln. It was found that a temperature of 120° F. maintained for 33 hours will destroy



Infested Coffee Bean,  
Magnified 3 Diameters

the infestation without damage to the coffee or its color, providing twelve hours are allowed for gradual cooling afterward.

Among the most destructive fungoid diseases is the so-called Ceylon leaf disease, which is caused by *Hemileia vastatrix*, a fungus related to the wheat rust. It was this disease which ruined the coffee industry in Ceylon, where it first appeared in 1869, and since has been found in other coffee-producing regions of Asia and Africa. America has a similar disease, caused by *Sphaerostilbe flavida*, that is equally destructive if not vigilantly guarded against.

The coffee-tree roots also are subject to attack. There is the root disease, prevalent in all countries, for which no cause has yet been definitely assigned, although it has been determined that it is of a fungoid nature. Brazil, and some other American coffee-producing countries, have a serious disease caused by the eelworm, and for that reason called the eelworm disease.

Coffee planters combat pests and diseases principally with sprays, as in other lines of advanced arboriculture. It is a constant battle, especially on the large commercial plantations, and constitutes a large item on the expense sheet.

#### *The Coffee Fruit*

The coffee fruit resembles a cherry, though somewhat elongated and having a small umbilicus in its upper end. The outer wrapping is a skin which is called the pulp. Next within is a gummy substance of mucilagenous consistency, sweetish to the taste. This gummy substance





CULTIVATING COFFEE IN BRAZIL

Showing how modern cultivation methods for weeding and harrowing are employed on a São Paulo estate.

surrounds, individually, each of two flat sided beans, or sometimes a single completely rounded bean; and each bean has an additional wrapping, comprising an outer, tough-textured "parchment" and an inner, delicate, "silver skin." The beans are usually of a round-oval shape, convex on the outside and flat on the inside, marked longitudinally in the center of the flat side with a deep incision. When one of the two seeds aborts, as frequently happens in the *arabica* variety, the remaining seed acquires a greater size and fills the interior of the fruit. A bean of this sort is known as a "peaberry," or male berry.

The various coverings of the coffee bean are almost always removed on the plantations in the producing countries. This involves the removal of four coverings—the outer skin, sticky pulp, parchment or husk, and closely adhering silver skin.

### Picking

Eight or nine months after blossoming, the coffee cherry ripens, becoming deep purplish-crimson in color. The ripening season varies somewhat according to climate and altitude. In the state of São Paulo, Brazil, the picking season lasts from May to September; while in Java, where three crops are produced annually, harvesting is practically continuous throughout the year. In Colombia the picking seasons are March-June and October-January. In Guatemala the crops are gathered from October through December; and in Venezuela, from November through March. In Mexico the coffee is picked from Novem-

ber to January; in Haiti, from November to March; in Arabia, from September to March; in Ethiopia, from September through November. In Uganda, practically every month except December and January; and in India the fruit is ready for picking from October to January.

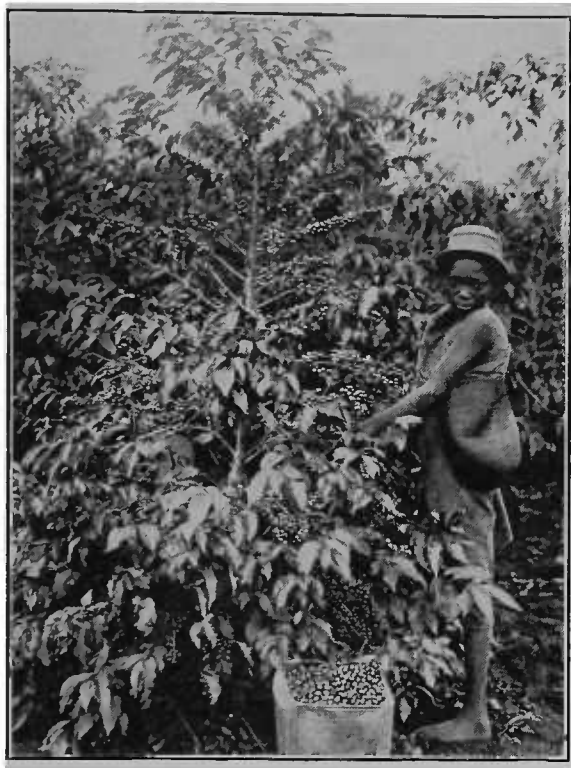
The general practice is to hand-pick the fruit, although in some countries the cherries are allowed to become fully ripe on the trees and fall to the ground. The earliest method, followed by the Arabs in Yemen, according to La Roque, was to let the cherries dry on the trees, and when they had shriveled the trees were shaken, causing the fruits to drop onto cloths spread to receive them. After a further sun-drying on mats they were husked by wood or stone rollers.<sup>1</sup>

Today there are two modes of coffee preparation known respectively as the "dry" or "natural" and the "wet" or "washed" methods. The dry method, followed in Arabia and many other countries, has largely given place to the wet method in some of the principal producing countries. For the dry method, the pickers frequently do not "pick" the cherries, but strip them from the branches—ripe, over-ripe, green berries, leaves, and dried twigs all going into the baskets. But for the "washed" method, the full red berries are picked individually from the branches;

<sup>1</sup> *Loc. cit.*



COFFEE TREE WITH RIPE CHERRIES, HAWAII



HARVESTING RIPE COFFEE, KENYA

at least that is what the overseers try to exact, but some green berries are always found among the ripe ones and when that occurs they are separated by the simple flotation process. On many large plantations the daily pickings are dumped immediately into great tanks of water. Green berries, sticks, leaves, etc., together with berries that contain one good bean and one malformed one, all float and are skimmed off. Stones, sand, and any heavy substances are caught in settling troughs and are thus prevented from entering and damaging the pulping machines.

The picking season is a busy time on a large plantation. All hands join in the work—men, women, and children—for it must be rushed. Over-ripe berries shrink and dry up. The pickers, with baskets slung over their shoulders, walk between the rows, gathering the ripe berries from the trees, using ladders to reach the top-most branches, and sometimes taking immature fruit in their haste to expedite the work. Good pickers can harvest 200 to 250 pounds of fruit, equal to 40 to 50 pounds of cleaned coffee in a day's picking, when there is a plentiful harvest. As the baskets are filled, they are emptied at a "station" in that particular part of the plan-

tation; or, in some cases, directly into wagons that move along with the pickers.

The coffee cherries are freed, as much as possible, from sticks, leaves, etc., accumulated in the picking operation, and are then transported to the preparation grounds which, on a large plantation, cover an open space of several acres; the plant including concrete-surfaced drying terraces, fermentation tanks, washing vats, mills, warehouses, stables, and machine shops. In Mexico this place is known as the *beneficio*.

#### *Preparation for the Market*

Originally, coffee was prepared for the market by drying it in the berry, before milling it. This is the "dry," or "natural," way, and hence the use of the words to indicate such coffees in the market. This method is still in vogue in most of Brazil, parts of Venezuela and Colombia, and many mild-coffee countries, where water is scarce during the harvesting season.

Under the newer "wet," or "washed," method of curing—where water is plentiful—the picked coffee cherries are fed by a stream of water into a float separator which removes stones, foreign matter, and light, defective beans; then into a pulping machine which removes the outer skin or pulp, permitting the gummy matter, surrounding the beans, to be loosened in fermenting tanks and then completely removed by further washings. This removal of the pulp, and the gummy substance, instead of allowing them to dry on the beans, makes the distinction between washed and unwashed, or "natural," coffees.

#### *The Dry Method*

The dry method of preparing the berries is not only the older method, but is considered by some operators as providing a distinct advantage over the wet process, since berries of different degrees of ripeness can be handled at the same time. However, the success of this method is dependent largely on the continuance of clear warm weather over quite a length of time, which cannot always be counted on.

In this process the berries are spread in a thin layer on open drying grounds, or barbecues, often having cement or brick surfaces. The berries are turned over sev-



WASHING COFFEE BERRIES IN COSTA RICA

This process is employed to soak the berries before sending them to the pulping machines. Most estates are equipped with sluice-ways which convey the picked coffee berries to the tanks as shown.

eral times a day in order to permit the sun and wind thoroughly to dry all portions. The sun-drying process lasts about three weeks; and after the first three days of this period, the berries must be protected from dews and rains by covering them with tarpaulins, or by raking them into heaps under cover. If the berries are not spread out, they over-heat, and the coffee becomes "hidey" or rancid, and frequently discolored. When thoroughly dry, the berries are stored, unless the husks—outer skin and inner parchment—are to be removed at once. Hot air, steam, and other artificial drying methods take the place of natural sun-drying on some plantations.

In the dry method, the husks are removed by threshing and pounding in a mortar, on the smaller plantations; or by specially constructed hulling machines, on the large estates.

#### *The Wet Method—Pulping*

The wet method, which produces the so-called "washed coffees" of commerce, is the more modern form, and is generally practised on large plantations that have an ample supply of water and sufficient capital to provide the extensive and somewhat costly machinery and equipment necessary.

On most of the plantations equipped for wet preparation, the freshly picked coffee cherries are dumped into large receiving tanks, from which they are floated by streams of running water directly into the hoppers of pulping machines which carry

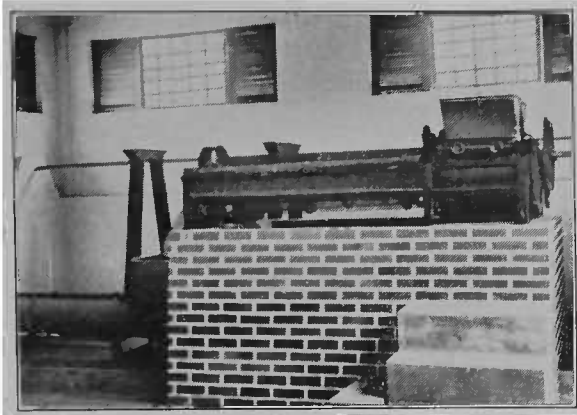
out the initial operation of the process. However, some of the plantations give the cherries a preliminary soaking in tanks full of water over night in order to soften the outer skins and make them easily removable by the pulping machines.

The object of the pulping operation is to remove the outer skins or pulp without injury to the coffee beans. The machines used for this purpose are of two types: cylindrical pulpers and the disc type. Either does good work if skilfully adjusted and operated, but it is quite essential to have due regard for variations in the quantity of the fruit pulp enveloping the coffee beans, caused by differences of rainfall, and care is required also that no green and immature cherries are inter-mixed with the ripe ones. These are likely to pass through the machine without having the pulp all removed, thereby affecting both the quality and color of the beans. A further consideration is to see that the cherries are pulped the day or day after they are picked, to avoid premature heating and fermentation, which affects the market value of the coffee.

It is difficult to achieve 100 per cent efficiency in pulping-machine operation, owing to variations in the size of the cherries, but in various Latin-American countries—notably in Costa Rica—the pulping operation receives the most careful attention, and high-class coffees are the result.

The cylinder pulper, latest style—suggesting a huge nutmeg-grater—consists of a rotary cylinder sheathed with a copper or brass cover punched with bulbs. These bulbs differ in shape according to the species, or variety, of coffee to be treated—*arabica*, *liberica*, *robusta*, *canephora*, etc. The cylinder rotates close to a breast with pulping edges set at an angle. The pulping is effected in the space between the cylinder and the doors of the breast by the rubbing action of the punched-copper cover, the amount of space being regulated to suit the size of the coffee. The cherries are subjected to a rubbing and rolling motion, in the course of which the parchment-covered beans become loosened. The pulp itself is carried by the cover and is discharged through a pulp shoot, while the pulped coffee is delivered through holes in the breast. Cylinder machines vary in capacity from 400 pounds (hand power) to 4,800 pounds (motive power) per hour.

Some cylinder pulpers are double, being



CYLINDER TYPE OF COFFEE PULPER, BRAZIL

equipped with rotary screens or oscillating sieves, that segregate the imperfectly pulped cherries so that they may be put through again. Pulpers are also equipped with attachments that automatically move imperfectly pulped material into a re-passing machine for another rubbing. Others have attachments to partially crush the cherries before pulping.

The breasts in cylinder machines are usually made with removable steel ribs; but in Brazil, Nicaragua, and other countries, where, owing to the short season and scarcity of labor, the planters have to pick, simultaneously, green, ripe, and over-ripe (dry) cherries, rubber breasts are used.

The disk pulper, the earliest type, having been in use more than seventy years, is the style most used in the Netherlands Indies and in some parts of Mexico. The results are the same as those obtained with the cylindrical pulper. The disk machine is made with one, two, three, or four vertical iron disks, according to the capacity desired. The disks are covered on both sides with a copper plate of the same shape, and punched with various punches. The pulping operation takes place in the spaces between the copper plates and lateral pulping bars, by rubbing action of the punched copper plates. As in the cylinder pulper, the distance between the surface of the bulbs and the pulping bars may be adjusted to allow of any clearance that may be required, according to the variety of coffee to be treated.

Disk pulpers vary in capacity from 1,200 pounds to 14,000 pounds of ripe-cherry coffee per hour. They are also made in combinations employing cylindrical separators, shaking sieves, and re-passing pulp-

ers, for completing the pulping of all unpulped or partially pulped cherries.

#### *Fermentation and Washing*

The next step in the process consists in running the pulped cherries into fermenting tanks, filled with water. The saccharine matter is loosened by fermentation in from hours to days. After fermentation the mass is stirred for a short time and, in general practice, the water is drawn off from above, to remove the light pulp floating at the top. The same tanks are often used for washing, but a better practice is to have separate tanks.

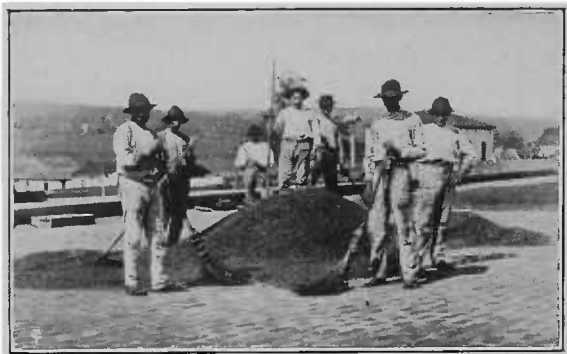
Some planters permit the pulped coffee to ferment in water. This is called wet fermentation. Others drain off the water from the tanks and conduct the fermenting operation in a semi-dry state, called "dry fermentation."

Fermentation is the most important step in the preparation of washed coffees, not only because of the assistance it gives in the removal of the mucilaginous pulp, but also because it governs the color and quality of the beans. There has been a great deal of discussion of the actual merits of the wet process as affecting coffee quality, but the answer apparently lies in the fact that coffee cured by the washed process commands a higher market price than similar coffee cured by the dry process.

The coffee bean, when introduced into the fermenting tanks, is enclosed in a parchment shell with its slimy, closely adhering saccharine coat. After fermentation, which softens the gummy covering, the beans are washed, either in washing tanks or by being run through mechanical washers. The type of washing machine generally used consists of a cylindrical tub having a vertical spindle fitted with a number of stirrers, or arms, which, in rotating, stir and lift up the parchment coffee. In another type, the cylinder is horizontal; but the operation is similar.

#### *Drying*

The next step in preparation is drying. The coffee, still "in the parchment," but now known as "washed coffee," is spread out thinly on a drying ground, as in the dry method. However, on many plantations, machines are used, drying the coffee



WORKING COFFEE ON DRYING FLATS, SÃO PAULO

in twenty-four to thirty hours instead of the usual four to eight days required for sun-drying.

The object of the drying machine is to take the place of the sun, in rainy weather. It dries the parchment of the coffee so that it may be removed as readily as the skin on a peanut; this is achieved by first whirling the bean in a centrifugal machine and then passing it through a cylindrical drier where a current of hot air removes the moisture. One of the best-liked types, the "Guardiola," resembles the cylinder of a coffee-roasting machine. It is made of perforated steel plates in cylinder form, and is carried on a hollow shaft through which the hot air is circulated by a pressure fan. The beans are rotated in the revolving cylinder; and as the hot air strikes the wet coffee, it creates a steam that passes out through the perforations of the cylinder. Within the cylinder are compartments equipped with winged plates, or ribs, that keep the coffee constantly stirred up to facilitate the drying process. Another favorite is the "O'Krassa." It is constructed on the principle just described, but differs in detail of construction from the "Guardiola," and dries its contents a few hours quicker. Hot air, steam, and electric heat are employed in the various makes of coffee driers. A temperature of 65° to 85° centigrade is maintained during the drying process.

A new apparatus for drying has been developed in Brazil, which turns out only soft qualities. The apparatus is a sort of kiln, employing heat and humidified air. It is claimed that this "dark heat," as it is called by Mr. José Luiz Dantas, the inventor, has the property of making all coffees—even the hardest kinds—into soft qualities, also ripening immature beans.

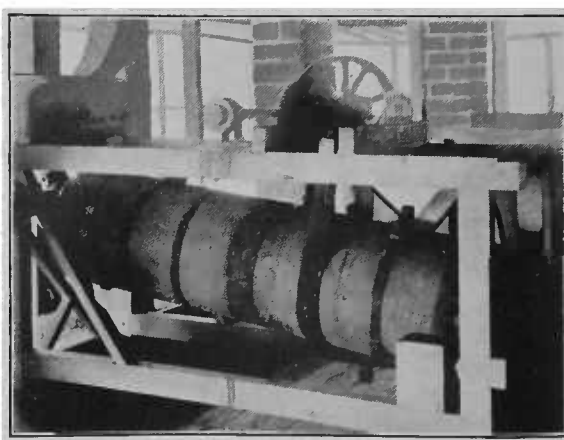
At the same time the apparatus is said to effectually kill the *Stephanoderes* bean-borer.

#### *Hulling and Polishing*

The last step in the preparation process is called hulling or peeling, both words accurately describing the purpose of the operation. Some husking machines for hulling or peeling parchment coffee are polishers as well. This work may be done on the plantation or at the port of shipment just before the coffee is shipped abroad. Sometimes the coffee is exported in parchment and is cleaned in the country of consumption; but practically all coffee entering the United States arrives without its parchment.

Peeling machines, more accurately named hullers, work on the principle of rubbing the beans between a revolving inner cylinder and an outer covering of woven wire. Machines of this type vary in construction. Some have screw-like inner cylinders, or turbines, others have plain cone-shaped cores on which are knobs and ribs that rub the beans against one another and the outer shell. Practically all types have sieve or exhaust-fan attachments, which draw the loosened parchment and silver skin out of the machine.

Polishers of various makes are sometimes used to remove the silver skin and to give the beans a special polish. Some countries demand a highly polished coffee; and to supply this demand, the beans are sent through another huller having a phosphor-bronze cylinder and cone. Much Guadeloupe coffee is prepared in this way, and is known as *café bonifieur* from the fact that the polishing machine is called



MECHANICAL DRIER, COLOMBIA



in Guadeloupe the *bonifieur* (improver). It is also called *café de luxe*. Coffee that has not received the extra polish is described as *habitant*; while coffee in the parchment is known as *café en parché*. Extra polished coffee is much in demand in the London, Hamburg, and other European markets. A favorite machine for producing this kind of coffee is the Smout combined peeler and polisher, the invention of Jules Smout, a Swiss. Don Roberto O'Krassa also has produced a highly satisfactory combined peeler and polisher.

For hulling dry-cherry coffee there are several excellent makes of machines. In one style, the hulling takes place between a rotating disk and the casing of the machine. In another, it takes place between a rotary drum covered with a steel plate punched with vertical bulbs, and a chilled iron hulling-plate with pyramidal teeth cast on the plate. Both are adjustable to different varieties of coffee. In still another type of machine, the hulling takes place between steel ribs on an internal cylinder, and an adjustable knife, or hulling blade, in front of the machine.

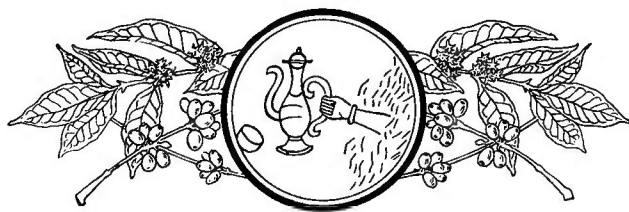
#### *Cleaning and Grading*

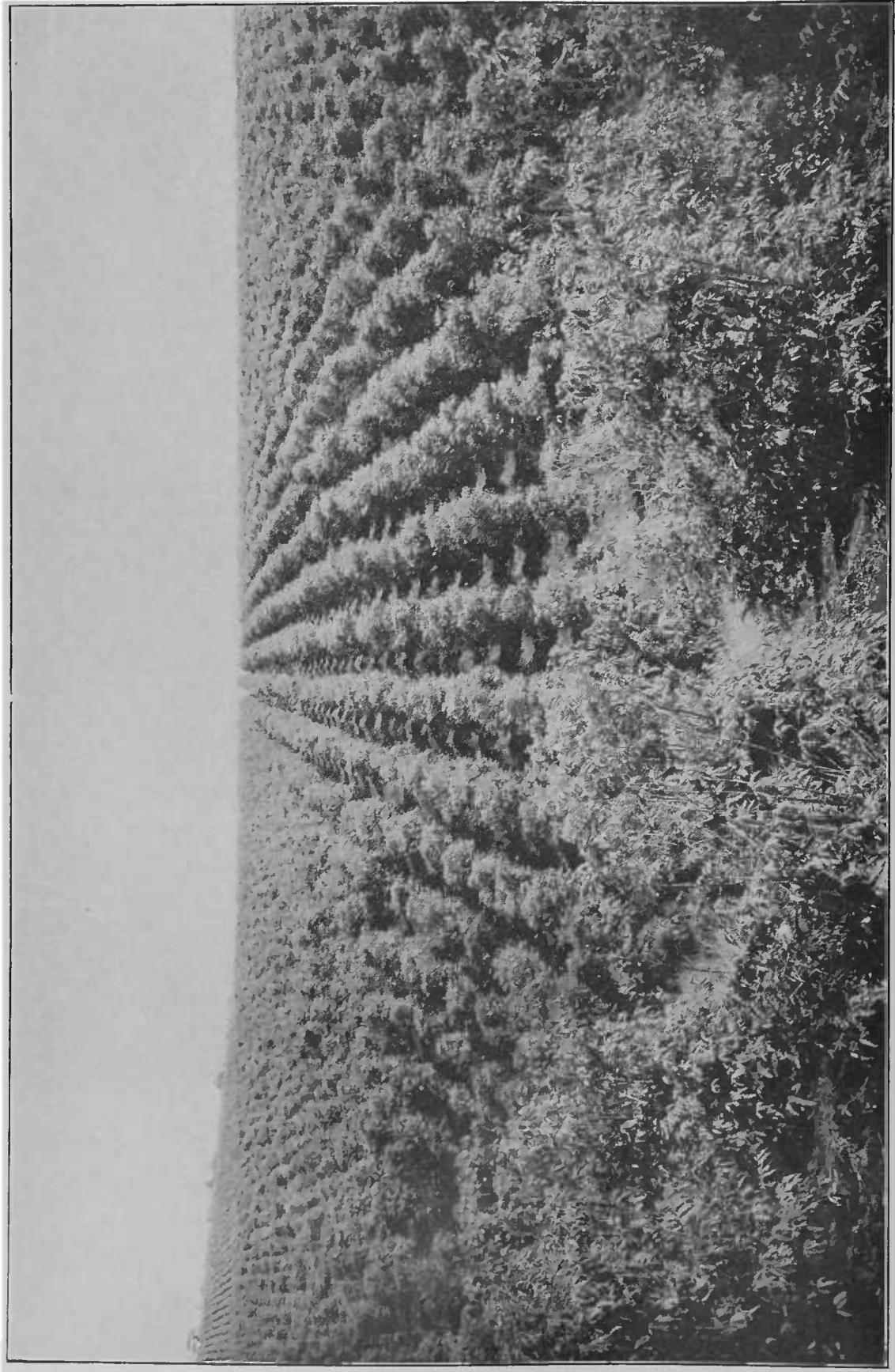
A pneumatic and gravity coffee-cleaning machine, known as the "Catador," removes extraneous matter, such as dust, shells and unmaturing and defective beans, thereby reducing the cost of hand-picking. The coffee is fed into a hopper near the top of the machine where it is met by an air-blast from a fan below. The lighter beans and dust are carried upward, while the heavy beans fall downward to an outlet spout. Various other separations deliver light coffee, dust, etc., at convenient outlets.

The coffee bean is now clean, the processes described in the foregoing having removed the outer skin, the saccharine pulp, the parchment, and the silver skin. This is the end of the cleaning operations; but there are two more steps to be taken before the coffee is ready for the trade of the world—sizing and hand-sorting. These two operations are of great importance; since on them depends, to a large extent, the price the coffee will bring in the market.

Sizing, or grading by sizes, is done in modern commercial practice by machines that automatically separate and distribute the different beans according to size and form. In principle, the beans are carried across a series of sieves, each with perforations varying in size from the others; the beans passing through the holes of corresponding sizes. The majority of the machines are constructed to separate the beans into five or more grades, the principal grades being triage, third flats, second flats, first flats, and first and second peaberries. Some are designed to handle "elephant" and "mother" sizes. The grades have local nomenclature in the various countries.

After grading, the coffee is picked over by hand to remove the faulty and discolored beans that it is almost impossible to remove thoroughly by machine. The higher grades of coffee are often double-picked; that is, picked over twice. When this is done on a large scale, the beans are generally placed on a belt, or platform, that moves at a regulated speed before a line of women and children, who pick out the undesirable beans as they pass. There are small machines of this type built for one person, who operates the belt mechanism by means of a treadle.





YOUNG COFFEE TREES ON A FAZENDA NEAR RIO PRETO, SÃO PAULO, BRAZIL

## CHAPTER XVI

### CULTIVATION AND PREPARATION IN BRAZIL

HOW AND WHEN COFFEE CULTIVATION WAS INTRODUCED ON THE AMAZON AND SPREAD SOUTHWARD TO BECOME THE CHIEF COMMERCIAL PRODUCT OF THE GREATEST COFFEE PRODUCING COUNTRY—RAPID PROGRESS OF THE INDUSTRY IN THE NINETEENTH CENTURY—BRAZIL'S PRINCIPAL COFFEE AREAS—HOW A COFFEE FAZENDA IS OPENED—PLANTATION LABOR—PLANTING AND CULTIVATING METHODS—PRUNING AND PICKING—THE "DRY" AND "WET" METHODS OF PREPARATION—PEELING, POLISHING, AND GRADING—INDUSTRIAL ORGANIZATIONS

**A**LTHOUGH coffee is not indigenous to Brazil, various economic and natural factors have combined to make it the chief commercial product, and to make Brazil the leading coffee producing country of the world, supplying 70 per cent of the total production. The first successful introduction of the plant into Brazil occurred in 1727, when Captain-Lieutenant Francisco de Mello Palheta brought seeds and plants from Cayenne, French Guiana, to the colony of Pará on the Amazon River.

Cultivation followed on a small scale in Pará and spread south to the neighboring province of Maranhão. The first recorded exportation—a sample from Pará—occurred in 1732. In 1743, another introduction took place when Judge José de Xerez Furna Uchôa brought a young coffee tree from the Jardin des Plantes, Paris, and planted it on his fazenda, "Santa Ursula," near Serra da Merouca in the state of Ceará.

Forty-three years after its introduction in the tropical north, or about 1770, coffee cultivation was begun in Rio de Janeiro. Advocate João Alberto Castello Branco is said to have brought two coffee plants from Maranhão, which were nurtured at the convent of the Barbadians. These plants are regarded by many as the progenitors of the great plantations in the states of Rio de Janeiro, Minas Geraes, and São Paulo.

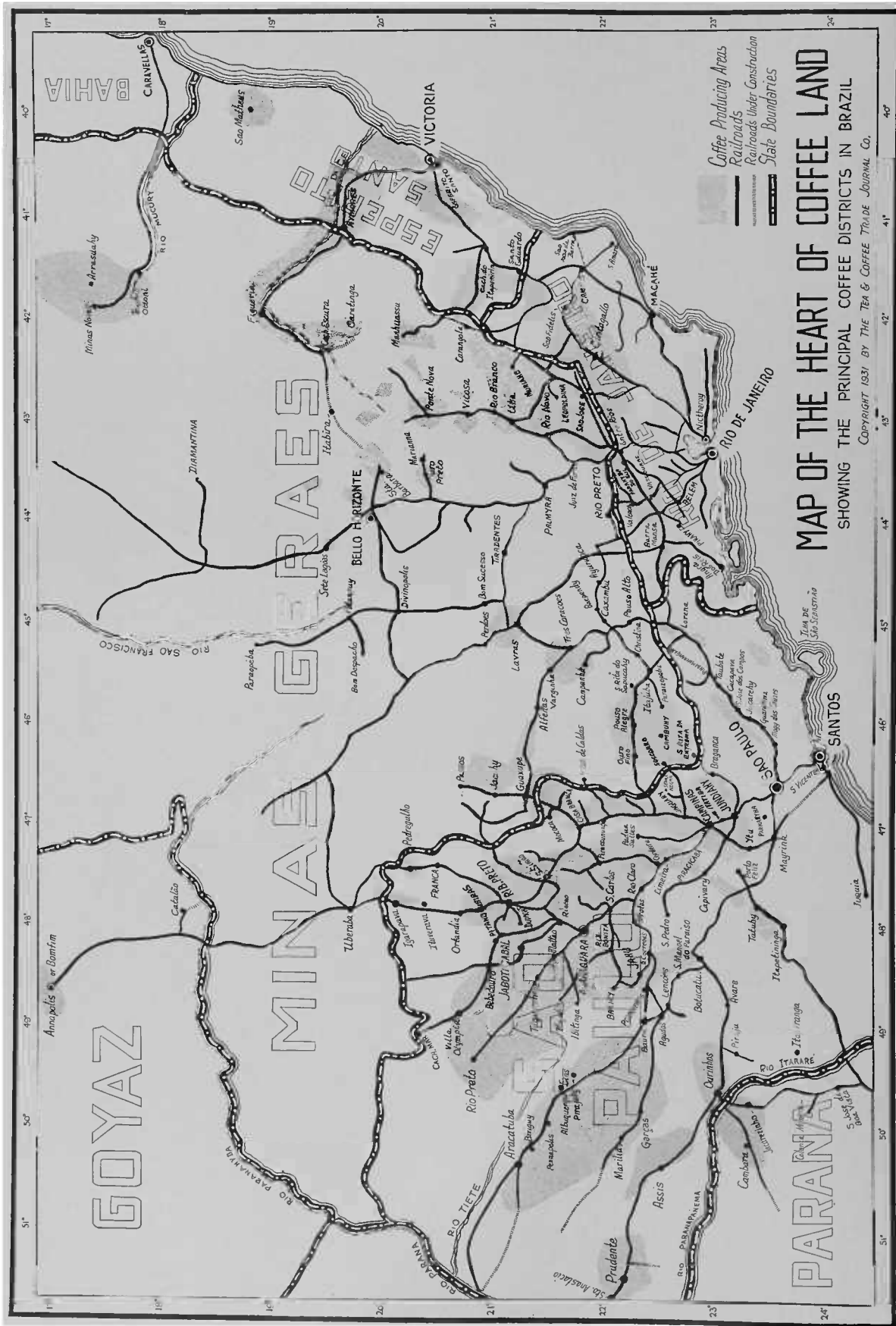
Another credible account has it that in

1774 a Belgian monk, Molke by name, presented the first seeds of coffee to the convent of the Capuchins in Rio. Certain it is that the pioneer plants were tended and nurtured by monks and friars.

Coffee emerged from the stage of an ornamental shrub when the Marquis de Lavradio, at Rio, heard of its commercial importance in Cuba, and encouraged its cultivation outside of the monasteries. He furnished seeds to John Hopman, an English merchant, who planted them in the garden of his estate, producing not only sufficient coffee for the use of his family but a small surplus which was sent to Lisbon in 1791. Shortly thereafter, Father Antonio Lopes da Fonseca, who cultivated a small fazenda on Campo Grande, supplied seeds and shoots to ecclesiastics having estates on the road to Minas, thus originating the coffee plantations at Rezende and Areias, and beginning the first actual commercial coffee cultivation in Brazil.

The appearance of coffee in the state of Bahia dates from 1778, and the cultivation spread to Pernambuco and Parahyba on the north. In 1822 coffee trees from Pernambuco were planted in Ceará, and an official memorandum in 1815 indicates the presence of coffee trees in Espírito Santo, probably brought there by the Capuchin friars of Rio.

The earliest reference to coffee-growing in the state of São Paulo is the official report of Captain-General Bernardo José de Lorena on the occasion of turning over his



# MAP OF THE HEART OF COFFEE LAND

SHOWING THE PRINCIPAL COFFEE DISTRICTS IN BRAZIL

COPYRIGHT 1931 BY THE TEA & COFFEE TRADING JOURNAL CO.

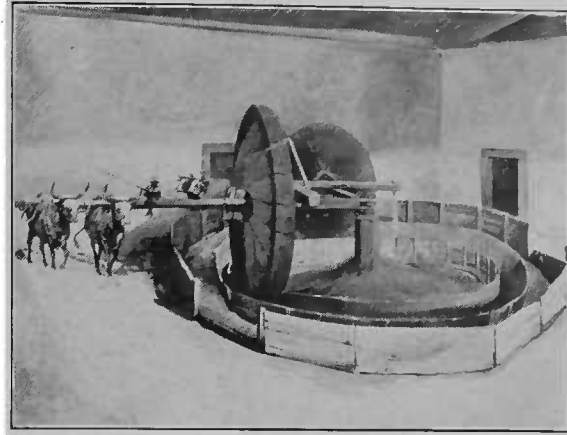
Captaincy, in 1797, to Governor Castro Mendonca. He enumerated among the agricultural resources of the governancy "much coffee in the village of Santos, and of the best quality." Other documents of the period mention shipments of 260 arrobas in 1798 produced along the coast near Santos. This implies the existence of coffee trees in Santos for at least six to eight years before that date, and it is believed the seeds were sent by sea from Rio by Marquis de Lavradio. Exports from the São Paulo ports of Ubatuba, Cuaragagatatuba, Iguape, Cananea, and São Sebastião between 1805 and 1807 are recorded by Mgr. Pizarro, and Robert Southey mentions in 1808 that "much coffee is grown near Santos," and that great plantations flourished at São Sebastião. In the beginning of the nineteenth century coffee culture penetrated the so-called "North of São Paulo," Areias being the first locality of the zone in which it was planted; and then Bananal, Silveiras, Lorena, and others of the Parahyba valley.

Arriving in São Paulo in June, 1797, Governor Castro Mendonca took a great interest in coffee, and made a present of a few seeds to his friend Sergeant-Major Raymundo Alves dos Santos Prado Leme, scion of a noble family. From the seeds planted by the sergeant-major in his garden at Jundiahy, sprang the tree which furnished seeds for the first plantations at Campinas.

Between 1807 and 1809 Lieut. Antonio Francisco de Andrade started a small coffee plantation in the borough of São Carlos, now the Campinas. In 1807 the botanist, Correa de Mello, wrote that Capt. Francisco de Paulo Camargo, one of the pioneers of Campinas, planted a *cafezal*. Because of the Napoleonic wars, the price of coffee fell below the cost of production and Capt. Camargo gave up coffee and turned his attention to sugar growing. Later on, the Camargo plantation having passed to a son, the abandoned coffee trees were restored to cultivation. The venture was successful and served as an incentive to other planters to take up coffee culture.

Numerous writers between 1817 and 1820 refer to coffee trees flourishing on small farms round-about the city of São Paulo.

Large crops were gathered in 1842 and 1843; and by the middle of the century, the plantations were producing annually more than 2,000,000 bags. In 1850, a crisis



AN EARLY HULLING METHOD IN BRAZIL

in the industry was caused by a severe frost, but progress was resumed in the following seasons. 1870-71 brought further havoc from frost.

At this time the fame of Ribeirão Preto's justly celebrated "red earth" began to attract the attention of coffee planters. There was a rush of pioneers and soon oceans of green coffee trees spread themselves toward Cravinhos, Jardinópolis, Sertãozinho, and Batataes. Other districts developed between the years 1880 and 1889.

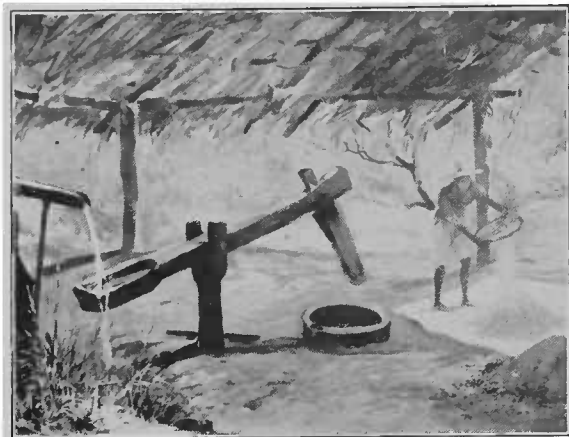
Coffee was introduced into Paraná in 1860; but received its greatest impetus in 1907, when Coronel Antonio Barboza Ferraz came from Ribeirão Preto and began its cultivation on a large scale in North Paraná.

#### *Brazil's Coffee-Growing Areas*

Brazil's commercial coffee-growing region has an estimated area of approximately 1,158,000 square miles, and extends from the river Amazon, on the north, to the southern border of the state of São Paulo; and from the Atlantic coast to the western boundary of the state of Matto Grosso. This area is larger than that portion of the United States lying east of the Mississippi River, with Texas added. Coffee is grown, more or less, in every state, if only for domestic use; but the principal coffee-producing states are São Paulo, Minas Geraes, Rio de Janeiro, Espírito Santo, Bahia, Pernambuco, Paraná, Ceará, Parahyba, Goyaz, Santa Catharina, Alagoas, Sergipe, and Matto Grosso.

The principal coffee areas are on plateaus, seldom less than 1,800 feet above sea-level, and ranging up to 4,000 feet.





OLD-TIME "MONJOLO" WATER-POWER HULLER

The mean annual temperature is approximately 70° F., ranging from a mean of 60.8° in winter to a mean of 72° in summer. There are records, however, of such extreme temperatures as 32° in winter and 97.7° in summer.

SÃO PAULO is the largest and richest coffee state. There are about 4,000,000 acres under coffee, with 1,475,000,000 trees—representing 48.36 per cent of Brazil's total. Practically all the coffee in São Paulo is of the *arabica* variety.

MINAS GERAES ranks second among Brazil's coffee-producing states. Its coffee cultivation is divided into three zones: the Sul de Minas (south); the Mogyana, similar in many characteristics to the Ribeirão Preto district of São Paulo; and the *Matta* (wilderness) of almost unknown extent. There are about 1,600,000 acres of land under coffee cultivation in the state, and 745,300,000 trees, representing 27.85 per cent of all the coffee trees in the country. The Bourbon variety is the one mostly grown, with Creoule next, and the Botucatú, Java, Conilon, and Maragogipe varieties also found.

RIO DE JANEIRO ranks third among Brazil's coffee states. There are over a million acres of land cultivated in coffee, with 279,300,000 trees, or about 9.5 per cent of the coffee trees in Brazil. Creoule, Java, Maragogipe, and Bourbon are the principal varieties grown.

ESPÍRITO SANTO—There are about 571,300 acres under coffee, with 237,500,000 trees, representing 5.8 per cent of all the coffee trees in Brazil. Creoule and Bourbon are the chief varieties, with some Maragogipe and Conilon.

BAHIA is the largest producer of coffee

among Brazil's tropical states. There are four coffee zones: the northern, centering around Bomfim, Jacobina, and Mundo Novo; the central, around Campestre, Lençoes, Andarahy, and Mucuge; the Feira de Sant' Anna, around the city of that name; and the southeastern, around Nazareth, Amargosa, and Velança. The area under coffee is 161,000 acres, with 71,200,000 trees.

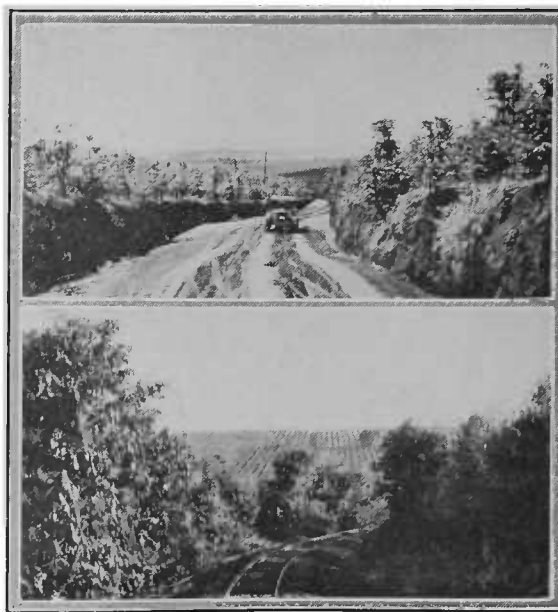
PERNAMBUCO—There is no concentrated coffee area, the production being scattered. The town of Garanhuns is the center of the coffee industry. There are 136,000 acres under coffee, with 66,100,000 trees.

PARANÁ—Coffee growing is confined to the northern zone. The soil is mostly rich *terra roxa* of great depth. There are approximately 61,750 acres under coffee, with some 33,700,000 trees.

OTHER STATES—Goyaz, Ceará, Parahyba, Santa Catharina, Alagoas, Sergipe, and Matto Grosso have areas under coffee of 115,304 acres with a total of 59,742,000 trees, which represent 2.01 per cent of the total in Brazil. Cultivation is mainly for local needs and other localities within the country. Only Santa Catharina, and, occasionally, Ceará, export a small amount.

#### Opening a Coffee Fazenda

The opening of a coffee fazenda begins with the selection of soil with the proper



TRAVEL SCENES IN RIBEIRÃO PRETO DISTRICT  
Upper—by motor; lower—by railway



YOUNG COFFEE PLANTS FRESH FROM THE NURSERY AND READY FOR TRANSPLANTING

characteristics, sufficient and well-distributed rainfall, freedom from frosts, plenty of running water for sluicing and treating the cherries, and transportation facilities to ports or intermediate markets. Most of Brazil's coffee districts are well supplied in all these respects, but when a suitable location has been found, a great amount of labor may be necessary to put the property in workable order, the clearing of virgin forests being often required.

In Brazil it has been found that coffee grows best and gives the greatest yield on the reddish clay soil known as *terra roxa*, and another that is yellow, dark red, or even black, known as *messape*, both under a sandy surface. The combined advantage of soil, climate, and altitude determine to a great degree the particular kind of coffee grown and its ultimate quality.

#### *Plantation Labor*

The care of the great coffee plantations requires ample manpower. The labor forces, or *colonos*, constitute large groups for which all-year-round accommodations are provided, with facilities for living and the raising of cereals, fruit, vegetables, and animals required for the livelihood of the workers and their families. During the

busy season, outside workers are added to the force.

The tasks of the *colonos* are not completed with the cultivation of the trees and the picking of the cherries, but continue through the period of preparation; their services being required throughout the year. The planters supply them with roomy, sanitary habitations, electric lights, ample ground for truck farming, etc. Throughout the industry pride in estate management and operation is the rule, applying equally to owners, overseers, and workers.

#### *Planting and Cultivation*

Brazil coffee is grown from seed, the best practice for raising replacements being to plant the seeds in shaded nursery beds and allow the seedlings to grow there for about a year before being transplanted into their permanent location. This style of planting, however, is too expensive where extensive new areas are involved, so the method generally followed is to grow each young shrub in a small pit directly in its permanent location without transplanting. Ten or twelve seeds are sown in two rows in each pit, which is hoed out approximately thirty centimeters long, twenty-wide, and twenty-five deep.



CLEANING AROUND COFFEE TREES DURING THE PICKING PROCESS, PARANÁ

In stripping the branches, many of the berries fall to the ground. Some growers use the newer method of picking mature berries from the branches, leaving the undeveloped ones.

Each pit is banked round-about with the loose soil hoed out, and is covered with billets—sticks of wood—for the first forty or fifty days, until germination begins, in order to keep the inner soil moist.

After germination the billets are separated a little, allowing the pits more air, and as soon as the young plants reach the top of the pit, the billets are laid up "log-cabin" fashion to shelter them.

The plants continue thus for from twelve to eighteen months or, in backward cases, for two years, until they are strong enough to withstand weather conditions. When the bushes get too thick, some of the plants are rooted out, leaving about half of them to constitute the future coffee tree.

It takes three or four years for a young orchard to start bearing, and during this period each tree must be cultivated with the utmost care by hand. Cultivation is done mostly with a hoe, although some cultivating machinery is used on the larger plantations.

Fertilizing has become increasingly necessary, in recent years, to build up some of the older plantings which have fallen below a paying yield. Practically all the

chemical fertilizers used are imported, but good results have been obtained also from stable manure and green legumes such as the cowpea, jackbean, and kindred plants, which are turned under before maturity.

#### *Pruning and Picking*

Brazil coffee planters, generally, prune only the useless sprouts from the trees, with the object of strengthening the main trunk, and not to reduce or keep the height of the trees low for picking. The sole consideration is the well-being of the trees.

The crop routine varies from the tropical north to the temperate southern border of the coffee belt, but usually the tree has three distinct flowerings, and sometimes four, one month apart. The delicate flowers burst into bloom in a scene of dazzling beauty on a single morning which is anxiously awaited as an indication of the impending crop. The flowers last only a few hours. The September and October flowerings are the most important, because the cherries mature at the best time for harvesting.

Picking starts as soon as possible after

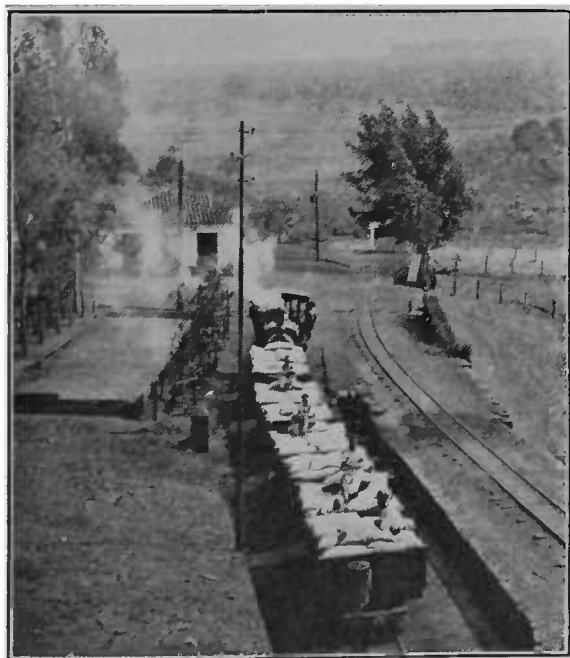


PICKING COFFEE ON A WELL KEPT FAZENDA IN RIBEIRÃO PRETO

the rains cease, generally in May, and covers a period of about six months. It is done by the *colonos*, men, women, and children, and outside help. Greater care is exercised in this today than formerly, as a result of the information and instruction spread among the planters by coffee experts. It is now deemed imperative that only the ripe cherries be picked and that no damage be occasioned to the green cherries and blossoms.

#### *Coffee Preparation*

The preparation processes immediately follow picking. The large fazendas in almost every instance have the latest mechanical aids, and in plantations of all sizes



RAILWAY TRANSPORT FOR COFFEE, RIBEIRÃO PRETO

some form of machinery and equipment is used. However, due to the nature of the product handled, a vast amount of hand labor is necessary, and great skill is shown by the laborers in such operations.

On some of the larger estates, particularly in São Paulo, private railways, provided with suitable sidings, extend from the preparation grounds through the fazendas. Other transport facilities are provided by *decauilles*, or portable track systems for small cars pushed by hand or hauled by mule, used on the terraces during the drying rushes; also by motor trucks, or wagons drawn by oxen, horses, or mules.

The preparation processes are generally carried through on grounds specially prepared and conveniently located. On the larger plantations the space covers several acres, including concrete-surfaced drying grounds, fermentation tanks, washing vats, mills, warehouses, stables, and machine shops. Running water is indispensable.

#### *The Dry Method*

Two methods are used in the processing: the "dry" and the "wet." In the dry method the cherries are dried, hulled, again hulled, and graded. On the arrival of the cherries from the pickers they are dumped into a large tank supplied by a stream of running water. Stones and other extraneous matter sink to the bottom, while the cherries float and are carried by the water to the cement-covered drying patio. In this stream, suitably situated and half the depth of the channel, are wooden baffles. These collect sand, dirt, or other undesirable matter and allow the passage of the cherries in a reasonably clean condition. The cherries are distributed, to a thickness of about three inches, on the patio where





STREAMS OF WATER CARRY THE COFFEE BERRIES TO THE DRYING FLATS



SPECIAL CARTS RECEIVE AND SPREAD THE COFFEE FROM THE CONDUITS

### SLUICING RIPE COFFEE FROM FIELD TO DRYING GROUND

On the Fazenda Guatapara the ripe cherries are collected from the trees and dumped into sluices of running water which carry them rapidly and inexpensively to the drying *terrios*.





HORSES AND MULES HELP WITH THE HANDLING OF COFFEE SPREAD OUT TO DRY ON THE TERRACES  
Modern equipment and the most progressive methods are the rule on the Fazenda Barboza, the newest of Brazil's great coffee plantations, near Cambria, Paraná.

they remain a few days, and are then turned over and pushed with a special long-handled wooden instrument, so formed as to raise the coffee into small ridges. This operation is continued daily, unless the cherries are soaked with rain, until it appears that the drying point is near.

The cherries are then collected into small heaps at night and spread out by day. Following this, they are gathered into a large heap and covered, protecting them from the rain and equalizing the drying; the latter being necessary for uniformity in the finished output. When nearly dry, the mass is transferred to the granary (*tulha*) to remain for a fortnight and undergo a light sweating. This treatment protects the green color and makes it possible to remove the parchment more easily in the subsequent process. Many planters hold their coffee in storage for several months before removing the parchment, the finished quality being said to improve with the added time.

#### *The Wet Process*

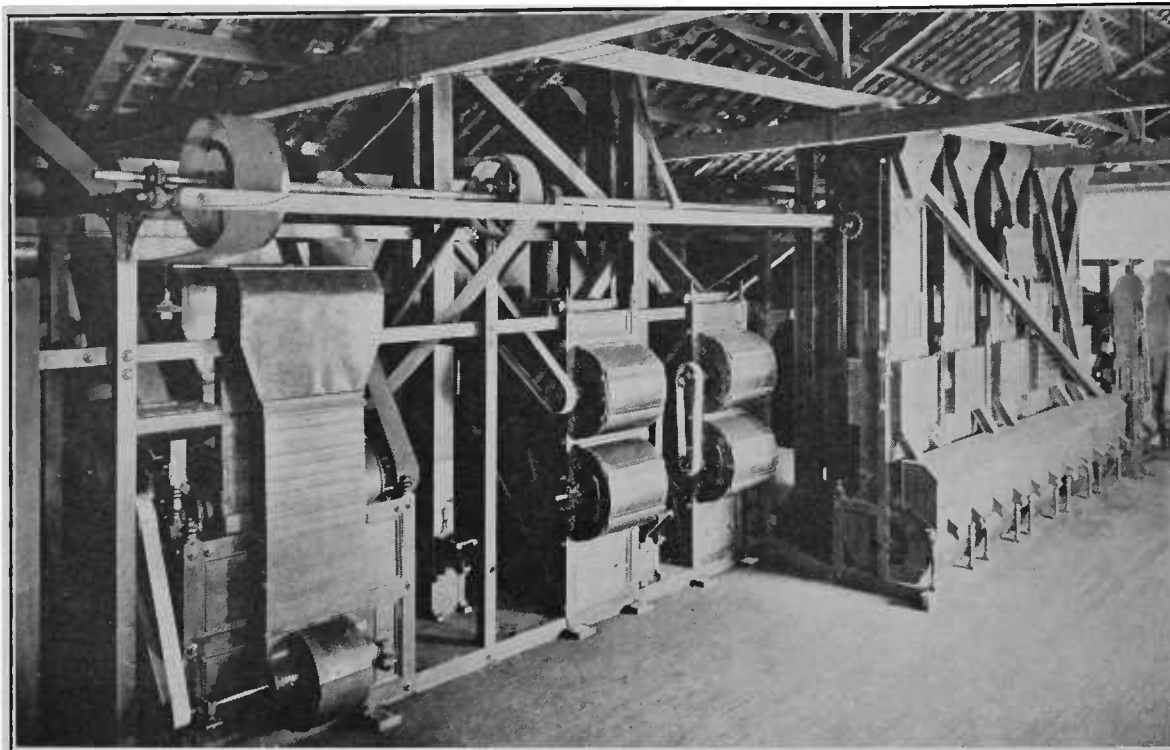
The wet method begins by dumping the cherries into tanks filled with water, from which they are carried by running streams, on the same day they are picked, into pulp-

ing machines which break the outer skins and free the underlying pulp, this being entirely removed through fermentation and further washing in tanks, and agitation in running water. After this they are passed through a machine for removing the water and are disposed in "repose" heaps for three or four days. During these operations fermentation goes on to a greater or less extent, with certain advantages or disadvantages to cup value, according to opinion.

Next, the berries are spread out on the drying grounds where, with suitable weather, they are allowed to remain for



DRYING GROUNDS, BOA VISTA ESTATE, SÃO SEBASTIÃO DO PARAISO, MINAS GERAES



CLEANING MACHINERY EQUIPMENT ON A WELL APPOINTED FAZENDA IN SÃO PAULO

about ten days. Often before full drying they are placed under shade to complete this process. With the larger producers, however, artificial drying is often effected by mechanical driers, and this is done during the course of twenty-four hours. When dry, by either method, the parchment is removed with light friction.

#### *Peeling, Polishing, and Grading*

Peeling off the parchment and polishing and grading the beans are the final steps. In the peeling operation, the berries are run between a revolving cylinder and an outer woven-wire mesh covering, which rubs off the parchment and polishes the berries. Automatic sizing, or grading, is done by machinery built particularly for this purpose. Nearly all the larger fazendas use steam power or electricity for these operations.

Manual sorting, which is accomplished with amazing rapidity and skill by *colonos*, separates the finished coffee beans from any remaining extraneous matter.

#### *Industrial Organizations*

Two schemes for the valorization of coffee in Brazil were initiated by the state of São

Paulo in 1906 and 1917, and when a similar market situation arose in 1921, a third valorization was launched by the Federal Government in cooperation with the state of São Paulo. During the period of the third valorization the Federal Government established a permanent defense of coffee by retention of stocks in interior warehouses.

After several years, the Government decided to give up the direction of coffee's defense, turning it over to the state of São Paulo. Therefore, on December 19, 1924, the state of São Paulo passed a law creating the Paulista Institute for the Permanent Defense of Coffee, which took charge of the federal regulatory warehouses and in 1925 was officially rechristened the Instituto de Café do Estado de São Paulo. A transportation tax of one gold milreis (55 cents) per bag of coffee was imposed to provide funds for the defense plan.

During 1927-28, seven principal producing states agreed to follow the São Paulo plan, by controlling entries at their shipping ports.

Following revolutionary disturbances, in 1930, a Federal decree in May, 1931, created the National Coffee Council, which was intrusted with the execution of various functions previously performed by the São Paulo Coffee Institute. Subsequently, the

functions of the Institute were concerned chiefly with the regulation of coffee shipments in the interior, regulation of warehouses, protection of planters, and propaganda for increasing coffee consumption.

The Institute carried out many plans helpful to growers and of benefit to the trade generally. Early in 1933, the Departamento Nacional do Café (DNC) came into being as a Federal body to assume control of all coffee institutes and associations in Brazil, superseding the National Coffee Council, which was abolished. The Coffee Institute of São Paulo, automatically came under the control of the DNC, and remains so at the present time.

The DNC, under the authority of the Ministry of Finance, of which it is a part, has control of coffee throughout Brazil as regards its cultivation, preparation, warehousing, financing, sale, and shipment. Its object is to improve quality, assure supplies adapted to demand, assist planters, and limit exports so as to prevent oversupply abroad and thus avoid price depreciation. Its policy, from the first, has been frank and its dealings with foreign consumers have won their confidence.

The DNC reconstructed Brazil's coffee position in the first two years of its existence. Other accomplishments in this period included the outright purchase of and payment for 11,556,674 bags of coffee retained in the interior warehouses; the retention and destruction of a 40 per cent "sacrifice quota" of the excessive 1933-34 crop; the building of new warehouses and sidings to keep pace with the increased crop volume; and the elimination by burning of all retained stocks. In 1935 the DNC indicated its belief that the need for further elimination had ceased to exist.

By a decree of the Federal Government in 1934 the life of the DNC was extended to December 31, 1938.

A Serviço Técnico do Café, or Technical Service of Coffee, was instituted by Federal decree, in 1934, to operate under the Ministry of Agriculture, as successor to the Technical Department of the DNC, its object being to continue the educational and

technical work of that department. Its seat is in the city of São Paulo.

Several plans have been worked out to encourage and increase the production of fine grades. These plans include the erection in the interior of pulping and drying plants designed to render the best service to the small producer at moderate rates, or in some cases, free of cost, the idea being to increase the production of "soft" coffees. Forty-two of these units are under construction or in operation, as follows: in Rio state, 17 pulping and drying plants, and 3 milling plants; in Pernambuco, 4 pulping plants; in Bahia, 3 pulping plants, 3 complete plants; in Espírito Santo, 12 pulping plants; and in Paraná, one pulping plant. In the state of Rio de Janeiro the plants reported completed are located at Bomfim, Padua, Miracema, Itaperuna, Lage, and Natividade. Plans have also been made for a large plant at Ipaussu, in the state of São Paulo, on the Sorocabana Railway, and another at Santo André on the São Paulo Railway between São Paulo and Santos.

In 1934, a plan was adopted for the co-operative marketing of Minas coffees, centering in the Minas Coffee Institute, formed in 1932, and composed of representatives of the growers, and now under the supervision of the DNC. Under this merchandising plan, there are three organizations, a coffee selling company, Companhia Cafeeira de Minas Geraes; a bank, Banco Mineiro de Café; and a warehousing company, Companhia de Armazens Geraes. One object is to establish "Minas" coffee under its own name in the world markets.

Other planters' organizations of note are the Sociedade Rural Brasileira, which is devoted to the general interests of planters and is not exclusively a coffee organization, and the Federação Paulista das Cooperativas de Café, in which membership is held through regional cooperatives, of which there are twelve, comprising owners of over 50 million trees. No dues or fees are required of members beyond an undertaking to deliver to the Society a part of their crops for marketing.



**COFFEE GROWING UNDER SHADE ON A LARGE HACIENDA**

Colombia's famous coffees are grown in the clear and bright sunshine of the mountainsides and foothills of three ranges of the Cordilleras.



**FACTORY AND FERMENTATION TANKS FOR COFFEE PREPARATION**

During the picking season the factories on the big haciendas, like the one illustrated, are hives of great activity.

**SCENES ON LA AMALIA COFFEE ESTATE, ANTIOQUIA, COLOMBIA**

## CHAPTER XVII

### CULTIVATION AND PREPARATION IN COLOMBIA

HOW NATURAL ADVANTAGES AND HIGHLY INTENSIFIED TECHNICAL PRACTICES HAVE COMBINED TO MAKE COLOMBIA THE GREATEST PRODUCER OF MILD COFFEES IN THE WORLD—THE INTRODUCTION AND EARLY HISTORY OF COLOMBIAN COFFEE—ITS SPREAD THROUGH THE MOUNTAINOUS INTERIOR DEPARTMENTS—GEOGRAPHICAL POSITION—COFFEE DISTRICTS—CLIMATE, SOIL, AND ALTITUDE—PLANTING, SHADING, AND CULTIVATION—PRUNING—PESTS AND DISEASES—HARVESTING—CROP PERIODS—LABOR—CROP PREPARATION—COFFEE MACHINERY—TRANSPORTATION—PROTECTIVE AND PROMOTIONAL BODIES

COLOMBIA ranks first among the world's "mild" coffee producing countries, and is second only to Brazil in point of total volume. This unique distinction is due in large measure to a peculiar combination of natural advantages and highly intensified technical practices in coffee culture. Nature has favored Colombia with a remarkably fertile soil and a climate that makes year-round coffee production possible; while the rugged, mountainous topography of almost the entire country affords ample altitude for the production of quality coffees. Economic factors, also, have united with natural advantages in making coffee the chief money crop of the country.

Coffee was introduced into Colombia, by way of the Venezuelan border, from the French Antilles some time in the latter half of the eighteenth century. It was cultivated on a small scale around Cúcuta, in the Department of Norte de Santander, by 1808, and a little later its growth spread southward to Bucaramanga in the Department of Santander. The Government, as a measure of encouragement, passed a law in 1821 prohibiting the importation of coffee, and in 1824 exempted coffee plantations from the ecclesiastical tax. From the Cúcuta and Bucaramanga districts coffee cultivation spread gradually into the Departments of Antioquia and Cundinamarca. The earliest recorded commercial exportation of coffee from Colombia occurred in 1834.

The first extensive coffee plantation in the country was established at Sasaima, Department of Cundinamarca, in 1867. Coffee was planted at Pereira, in the Department of Caldas, in 1886. This introduced the cultivation of coffee into extensive areas that ship via the Pacific Coast seaport of Buenaventura, supplying San Francisco and other important markets on the Pacific Coast of North America.

Notwithstanding the widespread introduction of coffee cultivation in various districts, the volume of production was limited for many years by lack of interior transportation facilities. In the Department of Antioquia, for example, ornamental coffee trees were common in the middle of the nineteenth century, but there was no volume of production until after the construction of the railway from Medellín to Puerto Berrio, in 1874. From this date the progress of coffee cultivation kept pace with the construction of various lines of railway which now connect coffee areas, often remote, with water transportation to foreign markets.

Modern methods of cultivation and preparation were introduced from Guatemala about 1882, and have been the basis of vast improvement since.

#### *Geographical Position*

Situated at the northwest corner of South America, Colombia, a country of lofty mountains, fertile temperate plateaus,



and tropical coasts, has the strategic advantage of seaports on both the Pacific and Atlantic coasts. The country is traversed from south to north by the Western, Central, and Eastern Cordilleras—lofty extensions of the Andean backbone of the South American continent. Between them are the two valleys of the Cauca and Magdalena rivers; the latter being the commercial artery of the country and the route by which coffee from mountainside fincas in the interior ultimately reaches the northern seaports.

The extremely rough and mountainous character of the country has made uneconomical any comprehensive plan of railway building. But, as an amelioration of this situation, the Magdalena River affords natural communication from the heart of the Republic, where Colombia's coffees are produced. It is navigable for a stretch of 500 miles, plus an additional 200 miles of its upper waters. Transportation from large sections of the interior also is provided by tributaries of the Magdalena. One of these, the Cauca, is navigable for 150 miles of its lower course and 227 miles on the upper river, above La Virginia.

#### *Coffee Districts*

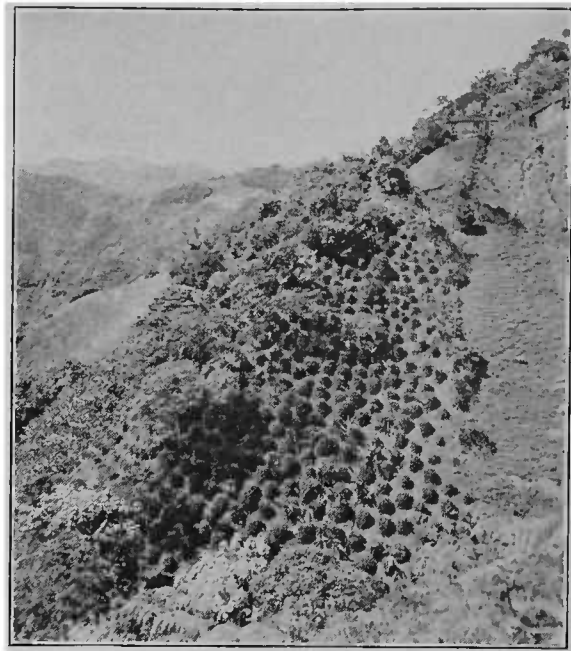
The coffee-plantation districts are located principally in the Departments—political and administrative divisions of Colombia—of Antioquia, Cundinamarca, Tolima, Caldas, Santander, Norte de Santander, Cauca, Magdalena, Valle del Cauca, Boyaca, Nariño, and Huila.

The principal district-type names, with the departments in which they are grown are shown in the accompanying table.

According to a census recently taken by the National Federation of Coffee Grow-

#### PRINCIPAL DISTRICTS AND TYPES

	<i>Department</i>
Manizales .....	Caldas
Armenia .....	Caldas
Bogota .....	Cundinamarca
Bogota Plantation .....	Cundinamarca
Girardot .....	Cundinamarca and Tolima
Honda .....	Cundinamarca and Tolima
Medellin .....	Antioquia
Tolima .....	Tolima
Cauca .....	Valle del Cauca and Cauca
Bucaramanga .....	Santander
Cúcuta .....	Norte de Santander
Ocaña .....	Norte de Santander



COFFEE GROWING IN CALDAS

ers of Colombia the total number of coffee trees in the country is 531,018,214. There are 149,348 plantations, of which 129,556 have less than 5,000 trees. There are only 321 with more than 100,000 trees. The industry is truly national, there being no more than 5 per cent of foreign capital invested in plantations.

#### *Climate, Soil, and Altitude*

Because of proximity to the equator—0° to 12° N. latitude—the temperature at any given altitude is practically the same throughout the year. Sudden climatic changes, which would affect plant growth, are unknown. Another important climatic factor is the regularity of the periods of rain and drought, which guarantee a normal development of the coffee plant, allowing it to bloom, bear fruit, and come to maturity under the most favorable conditions.

The soils of the Andes ranges, which constitute the coffee areas, are formed partly from disintegrated volcanic rock and partly from vegetative humus accumulations dating back many centuries. They are black in color and rich in chemical elements required by coffee.

Speaking generally, the coffee plantations are located at altitudes of from 2,500 to 6,000 feet, which afford temperatures from 65° to 75° F. The elevation, combined with the constant temperature, and

the moisture naturally gathered on the mountains make the terrain ideal for coffee culture.

#### *Planting*

Nursery planting is practised on the larger plantations, and when the plants are about 18 inches high they are transplanted into the prepared plantation at a distance of 8 to 14 feet apart. On the smaller or more primitive fincas nursery planting is omitted.

After the harvesting is over, groups of specially chosen pickers collect the cherries from choice trees that have been set apart from regular picking to serve as seed bearers. Only the best cherries are selected, and these are depulped by hand to avoid any damage to the seed. The seeds are planted in nursery beds and are shaded with a thatch of palm leaves or branches laid on a bamboo framework. The seedlings are sturdy enough for transplanting when they are about a year old. They bear their first fruit when four or five years old.

#### *Shading and Cultivation*

Shading is quite generally practised in the warmer districts, at the lower altitudes, and correspondingly less at higher elevations. Several varieties of shade trees are used, preference being given to leguminous varieties whose foliage meets high above the growing coffee, thus forming a screen that diffuses the sunlight. Several varieties of acacias are the most popular choice.

Cultivation generally is limited to weeding. Usually, some time before the flowering period, all weeds and creepers are removed, not only from the coffee plants themselves but also from the shade trees. And during this operation it is customary to scrape the trunks of the coffee trees free of mosses and like growths.

Hoeing is the principal means of cultivation, but some planters plow between the trees, and some are experimenting with fertilizers.

The National Federation of Coffee Growers is promoting modern cultivation methods, backing its campaign with a cooperative purchasing plan for farm implements, fertilizers, etc. and coffee experimental farms for the solution of cultivation problems.

Fertilizing has been unnecessary until recently, because of the native richness of

the soil, but some of the older plantations have begun to suffer from reduced yields, so many of the planters are using as green manures the weeds and creepers removed in the hoeing operation; also the mucilaginous part of the cherries, removed by the pulping machines. Quite recently, chemical fertilizers have come into use.

Small cultivations are the rule in Colombia, coffee plantations varying from one to ten hectares and providing sufficient space for the cultivator to produce enough coffee to furnish work for himself and the members of his family, who vie with their neighbors in the production of a superior product.

Probably the greatest progress in cultivation has been made on the large plantations of Antioquia, Cundinamarca, and Caldas.

#### *Pruning*

As practised in Colombia, pruning aims to provide sufficient openings in the foliage for the necessary sunlight to reach the lower branches, thereby assuring more abundant sap flow for fruit nutrition. In actual practice, however, many planters do little pruning, permitting the trees to become umbrella shaped, with the trunks and inner branches densely shaded, and with consequent impairment of sap flow. Ten to twelve feet is a fair average height for the trees.

#### *Pests and Diseases*

Colombia is a favored land in respect to the pests and diseases which attack its coffee trees, being singularly free from such inroads. The commonest diseases are "iron rust" and those caused by fungi. Pests responsible for some damage are plant lice, borers, and ants. Neglected plantations are likely to suffer from parasitic growth of moss.

Up to the present time there have been no visitations of such destructive pests as *Stephanoderes* nor any of the plagues that have destroyed the coffee trees in some other countries.

#### *Harvesting*

A careful gathering of the harvest and its preparation are facilitated by the favorable circumstance that there are two distinct cropping periods in Colombia. These comprise a primary or principal



COLOMBIAN COFFEE PICKERS

crop period and a secondary or small crop period, as shown in the accompanying table.

On account of the length of time which intervenes between the primary and secondary crops there is no question of hand work being done hurriedly, so there is no stripping of the branches. Ripe cherries, only, are taken one by one, and must be without imperfections. Any cherries that are badly shaped and leaves or other extraneous material that may affect the preparation are rejected. Harvesters know that if they pick cherries that are not in a perfect state of maturity they do so with prejudice to their own wages.

There is no artificial control over the crops nor their progress to world markets,

#### APPROXIMATE CROP PERIODS

Department	Principal Crop	Small Crop
Caldas <sup>1</sup>	Oct. to Dec.	Apr. to June
Antioquia	Oct. to Jan.	Mar. to May
Tolima	Mar. to June	Nov. to Jan.
Cundinamarca	Apr. to June	Oct. to Dec.
Valle	Mar. to May	Sept. to Dec.
Norte de Santander	Mar. to May	Oct. to Dec.
Santander	Aug. to Oct.	Practically none
Cauca	Apr. to June	Dec. to Feb.
Huila	Apr. to June	Oct. to Dec.
Magdalena	Nov. to Jan.	None
Boyaca	June to July	October
Nariño	May to July	Jan. to Feb.
Bolívar	Sept. to Nov.	None

<sup>1</sup>The time of the principal crop in the Quindío region, around Armenia, is between March and May, and the time of the small crop is between October and December.

so Colombian planters point with no little satisfaction to the fact that roasters and other people interested in the coffee business may secure coffee in the local Colombian markets at all seasons of the year.

#### Labor

As previously stated, labor on the smaller fincas, which produce the greater part of Colombia's crops, is largely a family affair. This condition is further augmented by the practice of some of the larger planters of sub-dividing their plantations into small rented parcels which are operated by tenant farmers and their families.

Necessarily, the larger plantations have to depend on hired help, and this demand is strongest at the harvesting periods. The amount of hired labor increases with the size of the plantation.

#### Crop Preparation

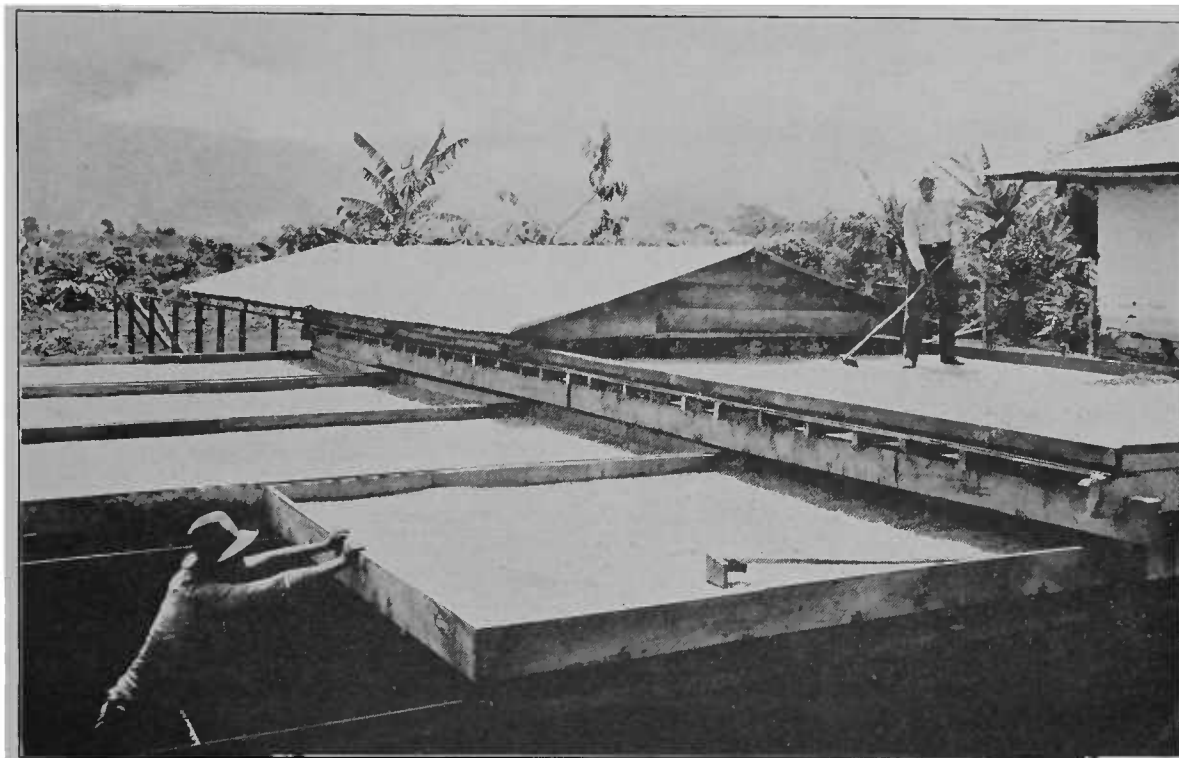
The wet, or "washed coffee," method of preparation is almost universally used, the proportion being about 90 per cent. By this process the ripe cherries are first run through pulping machines which separate the fruit from the outside pulp, exposing the sticky saccharine substance which surrounds the parchment.

"Naturals" or dry-process coffees, have only been produced in Bucaramanga, Cúcuta, and Ocaña. They are no longer produced on a commercial scale in Bucaramanga.

As soon as the coffee beans have been pulped they are submitted to from twelve to twenty-four hours of fermentation, according to the altitude, in order to remove the sticky substance. When this process



COFFEE-DRYING PATIO, LA AMALLA



SUN-DRYING COLOMBIAN COFFEE ON INGENIOUS SLIDING PLATFORMS

is completed, the coffee is washed in cement canals, tanks, or special canoes. The drying of the bean follows, a process which is brought about by the sun and air on the smaller plantations and on the larger ones by means of modern coffee drying apparatus. In this stage of preparation the coffee is known as *café pergamino*, and small quantities are exported without further preparation to some European markets which require it this way.

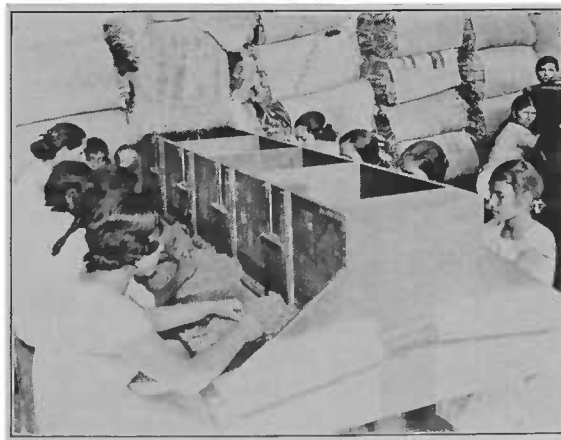
For markets like the U. S. A., which buy completely prepared coffee, the processing is continued by passing the thoroughly dried *pergamino*, or "parchment," coffee through a milling machine. With the exception of a few large plantations, mostly in Bucaramanga, the parchment coffee is taken to trade centers where it is sold to exporters who mill it before shipping it abroad.

Most Colombian coffees are shipped after hand-picking, without mechanical separation, as "General Outturn." About the only separating done is the removal of the peaberry and this is by no means general. On the other hand, the regions offering the finest quality coffees give great attention to the work of classification, the work of the machine being supplemented with hand-picking by women and children.

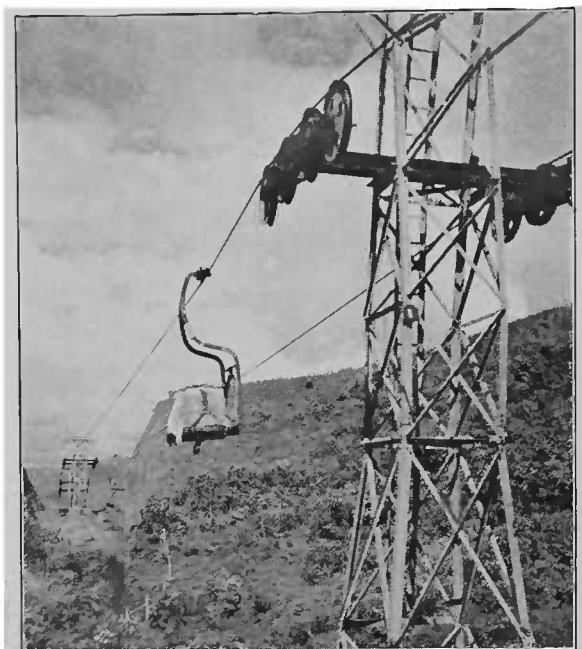
Government statistics of exports of coffee, unless otherwise specified, are based on bags of 60 kilos, a unit which, however, is employed only in the Cúcuta district.

#### *Transportation*

Owing to improved methods of transportation in Colombia, very little coffee, after it is bagged for export, is transported any longer by the picturesque mules of the early days. This is due to new cart roads suitable for motor trucks, and extensions of the railroads. Part of the Cúcuta dis-



GIRLS HAND-PICKING COFFEE, GIRARDOT



AERIAL CABLE-WAY FROM MANIZALES TO THE HONDA RAILWAY

trict coffees are now shipped out by the Magdalena River via Puerto Wilches. All Bucaramangas also go by that route. The Ocañas mostly reach the Magdalena by over-head cable-way. Girardots, Tolimas, and Hondas are shipped down the Magdalena to either Puerto Colombia or Cartagena; also the Medellins. The Manizales are mostly shipped by Buenaventura, although some go by the cable-way from Manizales to the Honda Railway and thence to the Magdalena. Some Medellins from the southern part of the Antioquia Department go by cable-way to Manizales, etc. Coffee can also be shipped from Manizales city by rail to Buenaventura. Practically the entire Manizales crop, including that of Pereira and the Risaralda Valley, is shipped via Buenaventura. Coffee from such recently remote points as Anserma and Rio Sucio now get out by motor and rail. Very little coffee is any longer shipped by the Cauca River. All the Armenias, Sevillas, Caucas, and Popayans reach Buenaventura by railroad.

#### *Machinery*

Coffee-preparing machinery is manufactured in various parts of the country; pulping machines of many types varying from those worked by hand to mechanically-powered machines with a speed gear to permit the velocity to be increased.

There are Colombian-made driers also, and various types of milling and classifying machines. In addition to Colombia's home products considerable foreign machinery is used—particularly drying and pulping apparatus.

Many cleaning mills, locally known as *trilladoras*, are scattered about the producing areas. They are provided with modern machinery and equipment. The *trilladoras* buy *pergamino* coffee and complete its preparation for market, or else do this work for producers at a moderate charge.

There are several roasting and grinding establishments which supply the coffee required for home consumption.

#### *Protection and Promotional*

THE NATIONAL FEDERATION OF COFFEE GROWERS OF COLOMBIA, composed of planters, brokers, exporters, and others interested in the coffee industry, has functioned since 1928 as the protective and promotional organization. The Government aids the Federation by means of an export tax of 10 cents gold per bag—the only export tax existing in Colombia. Law 76 authorized the Government to enter into a contract for ten years with the Federation to render certain services and to protect and develop the industry in exchange for the financial assistance represented by the 10-cents tax. At present there are some 35,000 coffee growers registered as members.

The activities of the Federation are directed by the following:

NATIONAL CONGRESS OF COFFEE GROWERS, which meets every two years in dif-



COFFEE TRANSPORT BY MULE-BACK, CALDAS





CENTRAL COFFEE FARM SCHOOL, LA ESPERANZA,  
OF THE FEDERACION NACIONAL DE CAFETEROS

ferent parts of the country and is composed of the Minister of Industries and delegates from each producing Department.

**NATIONAL CONGRESS OF COFFEE GROWERS**, the object of which is to enforce compliance with the law establishing contracts with the National Government and with the conditions dictated by the Congress.

**DEPARTMENTAL COMMITTEES** established in the capital of each Department.

**MUNICIPAL BOARDS**. One in each producing district.

**FEDERATION MANAGEMENT**. The Federation is headed by a manager, who is its legal representative in all public matters and represents directly or by delegation the interests of the Corporation in the Managing Boards of the Banco de la Republica and the Agricultural Credit Bank, in the National Economic Council, the Board of Agriculture, the Commission for the Control of Exports, and the International Coffee Congresses and Councils.

The Management, which is located in

Bogota, has its offices divided into Scientific, Technical, Commercial, Statistical, and Accounting departments. It maintains a group of scientific agriculturists and coffee experts who visit the various coffee zones of the country to give free instruction and demonstrate the cultivation and preparation of coffee to all planters, and to enroll them in the National Federation of Coffee Growers. Bags, artificial fertilizers, insecticides, and tools are sold to cultivators at cost price. For the training of its group of experts and for experiments and demonstrations the Federation conducts experimental stations where coffee is grown, cultivated, pruned, etc.

The Federation publishes an official or-

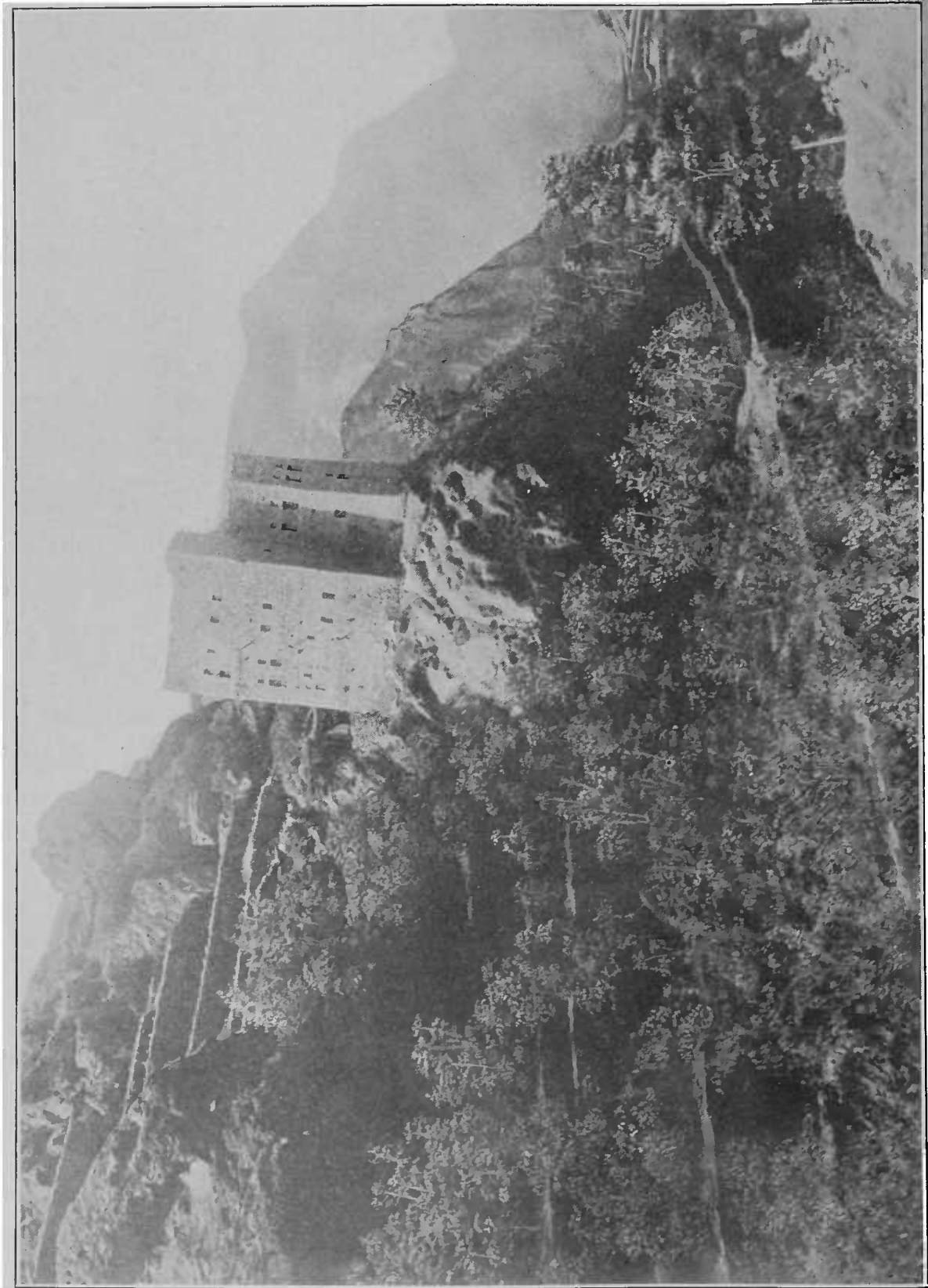


COFFEE INSPECTION, BOGOTA, BY THE FEDERACION  
NACIONAL DE CAFETEROS

gan, the *Revista Cafetera*, which is distributed free to all the federated coffee cultivators and to agricultural institutions both in the country and abroad.

The Federation also publishes a *Statistical Bulletin*, which is sent free to interested firms abroad.





A RARE PICTURE SHOWING MOCHA COFFEE GROWING ON TERRACES IN YEMEN, ARABIA

## CHAPTER XVIII

### CULTIVATION AND PREPARATION IN OTHER COUNTRIES

BRIEF HISTORICAL AND TECHNICAL OUTLINES OF ALL COFFEE-PRODUCING COUNTRIES OF ANY IMPORTANCE, NOT COVERED IN THE PRECEDING CHAPTERS—SOME FIFTY-ODD COUNTRIES ALPHABETICALLY ARRANGED FOR READY REFERENCE—THE PECULIARITIES, IF ANY, WHICH DISTINGUISH THEIR METHODS OF PRODUCTION, FROM ABYSSINIA AND ARABIA, WHERE THE EARLIEST TECHNIQUE WAS DEVELOPED AND STILL OBTAINS, TO KENYA, THE MARKETING CENTER OF THE NEWEST COFFEE AREA, AND VENEZUELA, WHICH RANKS THIRD AMONG THE WORLD'S GREAT PRODUCING COUNTRIES

THERE are some fifty-odd other countries where coffee production is of more or less importance in the local economic situation, and in many instances is of great importance to the countries to which the coffees are shipped. The following paragraphs mention any peculiarities that distinguish these countries, which have been arranged alphabetically for ready reference. The fundamental methods of coffee cultivation and preparation, which have been fully described in the three preceding chapters, are not repeated here.

ABYSSINIA, officially Ethiopia, which gave coffee to the world, no longer figures as a prime factor in the world's supply, exporting only a limited quantity. There are produced in the country two coffees known to the trade as Harari and Abyssinian, the former being by far the more important. The Harari is the fruit of cultivated *arabica* trees grown in the province of Harar, and mostly in the neighborhood of the city of Harar, capital of the province. The Abyssinian is the fruit of wild *arabica* trees that grow mainly in the provinces of Sidamo, Kaffa, and Guma.

The coffee of Harar is known to the trade as Mocha longberry or Abyssinian longberry. Most of the plantations upon which it is raised are owned by the native Hararis, Galla, and Abyssinians, although

there are a few Greek, German, and French planters. The trees are planted in rows about twelve or fifteen feet apart, and comparatively little attention is given to cultivation. Crops average two a year, and sometimes even five in two years. The big yield is in December, January, and February. The average crop is about seventy pounds, and is mostly from small plots of from fifty to one hundred trees, there being no large plantations. All the coffee is brought into the city of Harar, whence it is sent on mule-back to Dire-Daoua on the Franco-Ethiopian Railway, and from there by rail to Jibuti. Some of it is exported directly from Jibuti, and the rest is forwarded to Aden, in Arabia, for re-exporting.

Abyssinian, or wild, coffee is also known as Kaffa coffee, from one of the districts where it grows most abundantly in a state of nature. This coffee has a smaller bean and is less rich in aroma and flavor than the Harari; but the trees grow in such profusion that the possible supply, at the minimum of labor in gathering, is practically unlimited. It is said that in southwestern Abyssinia there are immense forests of it that have never been encroached upon except at the outskirts, where the natives lazily pick up the beans that have fallen to the ground. It is shelled where it is found, in the most primitive fashion, and goes out in a dirty, mixed condition.



A GALLA COFFEE GROWER AND HIS HELPER, IN HIS GROVE OF YOUNG TREES NEAR HARAR

Formerly, much of this Kaffa coffee was sent to market through Boromeda, Harar, and Dire-Daoua. Now practically all of it goes to Gambela, thence by steamers to Khartoum, and by rail to the shipping point at Port Sudan on the Red Sea.

Little machinery is used in the preparation of coffee in Abyssinia; none, in preparing the coffee known as Abyssinian; and only in a few instances in cleaning the Harari coffee, the fruit of cultivated trees. Both classes are raised mostly by natives, who adhere to the old-time dry method of cleaning. In Harar, the coffee is sometimes hulled in a wooden mortar; but for the most part it is sent to the brokers in parchment, and is cleaned by primitive hand methods after its arrival in the trading centers.

Still another coffee, which takes its name from Arussi, the province in which it is grown, was first planted by two Belgian companies in 1912. All development was halted by civil wars in 1918, but following that year work was resumed by a merger of the two original companies into the Société des Plantations d'Abyssinia. Modern methods were introduced, roads built, and approximately 2,500 acres are now under cultivation. The coffee is of good quality, similar to Harari, but the bean is duller in color. It is known as Mocha of Arussi and

is marketed in Havre and Antwerp. The average annual crop is about 1,000,000 pounds.

Abyssinian coffee is brought to the larger local markets by mule caravans, and is shipped to Jibuti via the Franco-Ethiopian Railway. Excepting the plant on the Arussi plantation, all coffee exported from Abyssinia is cleaned and packed in Jibuti. The cleaning is done by Somali women. There is but one small cleaning plant in Addis-Ababa, the output of which is commercially unimportant.

ANGOLA. Coffee is gathered and sold by the natives of this African country, but there are also several European companies engaged in the coffee business. The chief coffee belt extends from the Quanza river northward to the Congo at altitudes from 1,500 to 2,000 feet. In the Cazengo Valley wild coffee trees grow so thickly that thinning out is the only operation required of the plantation owner. When they grow too tall the coffee trees are cut off about two feet above the ground, and new shoots appear the following season. The harvest begins in June, and it is often necessary for the government to lend native soldiers to the planters to aid in harvesting, as the labor supply is insufficient. After picking, the beans are dried in the sun from fourteen to forty days, depending upon the

weather. After drying, they are brought to the hulling and winnowing machines. There are now about twenty-four of these American-built machines in the Cazengo and Golungo districts.

ARABIA. Once all the coffee of Arabia went to the outside world through the port of Mocha, which never raised any coffee. The port is no longer of commercial importance; but its name has been permanently attached to the coffee of this country.

*Mocha, Moka, or Morkha* coffee, i.e., *Coffea arabica*, is raised principally in the vilayet of Yemen, a southeastern district. Yemen is a rugged, mountainous region, in which innumerable small valleys at high elevations are irrigated by waters from the melting snows of the mountains.

Coffee can be successfully grown in any part of Yemen, but its cultivation is confined to a few widely scattered districts, and the acreage is not large. The principal coffee regions are in the mountains between Taiz and Ibb, and between Ibb and Yerim, and Yerim and Sanaa, on the caravan route from Taiz to Sanaa; between Zabeed and Ibb, on the route from Taiz to Zabeed; between Hajelah and Menakha,

on the route from Hodeida to Sanaa, and in the wild mountain ranges both to the north and south of that route; between Beit-el-Fakih and Obal; and between Manakha and Batham to the north of Bajil. The plant does best at elevations ranging from 3,500 to 6,500 feet.

In the Yemen district, coffee is generally grown in small gardens. The seeds are thoroughly dried in ashes, and after being placed in the ground, are carefully watched, watered, and shaded. In about a year the shrub has grown to a height of twelve or more inches. Seedlings of that size are set out in the gardens in rows, about ten to thirteen feet apart. The young trees receive moisture from neighboring wells or from irrigation ditches, and are shaded by bananas.

At maturity the trees reach a height of ten or fifteen feet. In some districts, the trees have two or even three crops a year. The trees begin to bear about the end of the third year.

The fruit ripens in August or September, and picking continues from then until the last fruits ripen late in March following. The cherries, as they are picked, are left to dry in the sun on the house-top



ROBUSTA COFFEE GROWING UNDER THE SHADE OF TALL RUBBER TREES, BELGIAN CONGO





HARVESTING THE RIPE COFFEE CHERRIES IN COSTA RICA

terrace or on a floor of beaten earth. When they have become partly dry, they are hulled between two small stones, one of which is stationary, while the other is worked by the hand power of two men who rotate it quickly. Another drying of the hulled berry follows. It is then put into bags of closely woven aloe fiber, lined with matting made of palm leaves, and sent to the local market.

In Aden and Hodeida the bean is submitted to further cleaning by the principal foreign export houses to whom it has come from the mountains in rather dirty condition. Indian women are the sole laborers employed in these cleaning houses. First, the coffee beans are separated from the dry empty husks by tossing the whole into the air from bamboo trays, the workers deftly permitting the husks to fly off while the beans are caught again in the tray. The beans are then surface-cleaned by passing them gently between two very primitive grindstones worked by men. A third process is the complete clearing of the bean from the silver skin, and it is then ready for the final hand picking. Women are called into service again, and pick out the husks, quaker or black beans, green or immature beans, white beans, and broken beans, leaving the good beans to be weighed

and packed for shipment. The cleaned beans are known as *bun safi*; the husks become *kisher*. Some of the poorer beans also are sold, principally to France and Egypt. Hand-power machinery is used to a slight extent; but mostly the old-fashioned methods hold sway.

The Yemen, or Arabian package, contains one bale, known as a half, and weighing eighty kilos, or 176 pounds, net.

AUSTRALIA. Queensland is the only State in which coffee cultivation has been attempted on a commercial basis, but the results have not been satisfactory. The area under coffee reached its highest point in the 1901-02 season with 547 acres. Thereafter it declined and in 1934 only 10 acres remained.

BELGIAN CONGO. Although several varieties of wild coffee are indigenous to the Belgian Congo, together with the mandate of Ruanda and Urundi, a huge irregular area of about one million square miles, it was not until 1885 that cultivation was begun. Ten years later 500,000 plants had been set out. *Coffea liberica* was the variety chosen for the greater part of the plantations. Formerly an independent State, the country was taken over by Belgium in 1908, and the chief development of coffee cultivation has occurred since then. One

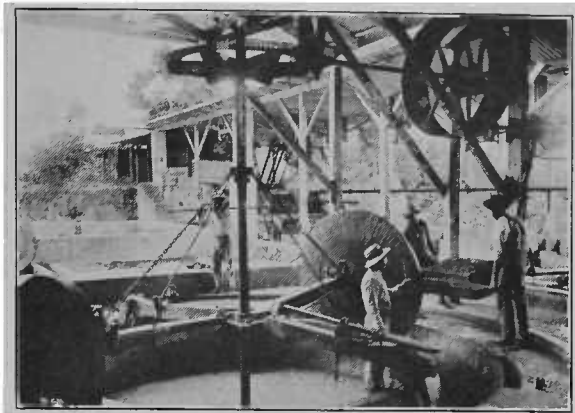
particular variety of Congo coffee, *Coffea laurenti* Wild, or *Coffea canephora* Pierre, commonly known as *robusta*, gave particularly satisfying results under cultivation. For the last twenty years the colonists have been interested in cultivating *robusta* coffee, and since 1913 the exports have been almost exclusively of that variety. Exportation is made through the port of Matadi, at the mouth of the Congo River.

**BOLIVIA.** There is no methodic cultivation of coffee. It vegetates spontaneously from the earlier plantings of ornamental shrubs or hedges which separate cultivated fields. Although the existing plants yield freely, the local demand easily absorbs the production outside of occasional, merely nominal, exportations.

**BRITISH HONDURAS,** despite its close geographical relationship to several of Central America's best coffee-producing countries, has never undertaken coffee raising on a commercial scale. It even fails to produce enough for local consumption, importing most of the coffee consumed.

**CEYLON.** Coffee planting in Ceylon was an important industry for a century, until the so-called Ceylon leaf disease attacked the plantations in 1869, and a few years later had practically destroyed all the trees of the country. However, the climate and soil of Ceylon seem adapted to coffee culture, and the experimental station at Peradeniya has been experimenting in recent years with *robusta*, *canephora*, *ugandae*, and a *robusta* hybrid for the purpose of reviving the industry.

**CHILE, URUGUAY, AND ARGENTINA.** Coffee is of minor, almost insignificant, importance in the agriculture of Chile, Uruguay,



COFFEE-HULLING MACHINE, COSTA RICA

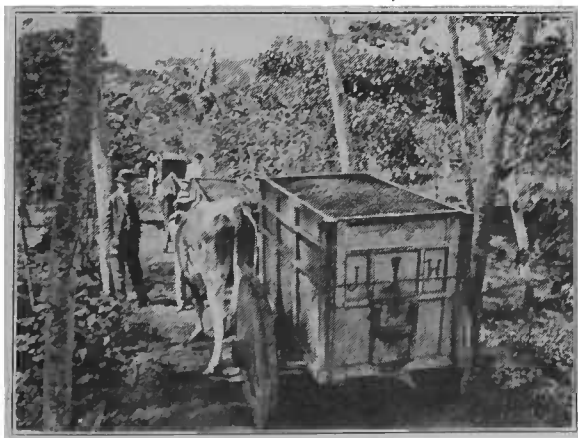
and Argentina. In Uruguay the climate is altogether unsuitable for it.

Argentina has small growing districts. Only the provinces of Salta and Jujuy have a little coffee under cultivation.

**COSTA RICA.** This little Central American country has made an enviable reputation for itself as a producer of high-grade coffees. Authorities differ as to the exact date when coffee cultivation was introduced; one account states that plants were brought from Cuba in 1779 by a Spanish voyager, Novarro, and another credits the first introduction to Padre Carrazo, several years later. At first, Costa Rican coffee was exported exclusively to South America, but in 1843 Captain William le Lacheur, commanding the British ship, "Monarch," arrived at Puntarenas, the principal port on the Pacific side, and persuaded the Costa Rican producers to let him transport their coffee to the London market and sell it there, acting as their agent. So successful was the outcome that for over ninety years Costa Rica has exported most of her coffee to the London market, where it has a high reputation for quality. Germany and the U. S. A. are Costa Rica's next-best customers, with a small remainder distributed to a number of other countries.

Costa Rica was one of the first countries of the western world to use coffee-cleaning machinery. Marcus Mason, an American mechanical engineer then managing an iron foundry in Costa Rica, invented three machines for pulping, cleaning, and polishing coffee.

CUBA produces enough coffee to supply the local demand, with an appreciable surplus left over for export. Coffee is grown to some extent throughout Cuba, but the



HAULING COFFEE CHERRIES, COSTA RICA



PICKING COFFEE ON SLOPES OF THE CANDELARIA HILLS, PROVINCE OF PINAR DEL RIO, CUBA

industry has attained first importance only in Oriente Province—the eastern tip of the island—with the Province of Santa Clara—central Cuba—ranking second in production.

**DOMINICAN REPUBLIC.** Coffee is one of the staple productions, as in the adjoining Haitian Republic. Said to have the world's richest and most productive soil, one-half of the republic's area is particularly suited to the cultivation of a good grade of coffee of the highland type. But political and industrial conditions have made for neglect of its cultivation by efficient methods. Lack of suitable roads has also militated against the development of the coffee industry.

In spite of many drawbacks, it is to be noted that, from the beginning of the twentieth century, the coffee-growing area has been gradually expanded. Exports increased from less than 1,000,000 pounds in 1900 to 26,000,000 pounds in 1933.

The principal plantations are in the vicinity of the town of Moca and in the districts of Santiago, Bani, and Barahona. Generally speaking, the methods of cultivation and preparation in the Dominican Republic are somewhat crude as compared with the practice in the larger countries of production in Central and South Amer-

ica. However, machinery is being introduced.

**ECUADOR.** Though not of great commercial importance, coffee in Ecuador grows on both the mainland and on the adjacent islands. The area planted to coffee is estimated at 128,000 acres, having an aggregate of about 32,000,000 trees. The trees blossom in December, and the picking season is through April, May, and June.

**ERITREA.** With the assistance of the Italian Colonial Government coffee cultivation was introduced in 1923. From a start of but six coffee plantations in that year the number increased to 134 in ten years.

**FRENCH COLONIES** have asserted their importance as coffee producers by jumping their exports from 213,000 bags in 1930-31 to 425,000 bags in 1934-35. The explanation lies in the fact that in France colonial coffees enjoy a preferential tariff of Frs. 345 per 100 kilos, therefore her colonies are beginning to produce a whole range of qualities, from Robustas in Madagascar to Arabicas in the Cameroons, and can consequently supply substitutes for many foreign growths, particularly since Brazil adopted a policy of no longer exporting low grades. Madagascar, which represents

about 70 per cent of the total production from the French Colonies, looks forward to an increase of her present exports up to a maximum of 500,000 bags, but the other colonies have no present means of approaching such figures.

The coffee-producing French Colonies are MADAGASCAR, NEW CALEDONIA—NEW HEBRIDES (two island colonies in the South Pacific), FRENCH WEST AFRICA, FRENCH EQUATORIAL AFRICA, CAMEROONS, INDO-CHINA, and GUADELOUPE. Needless to add, the coffee exportations from the colonies go exclusively to France, on account of the preferential tariff, and at the time this is written they represent about 10 per cent of the total French importations.

FRENCH CAMEROONS produce a wide range of coffee qualities, both washed and unwashed. A great effort has been put forward to develop the coffee industry as a colonial source of supply for French markets. However, lack of machinery and means of transport are obstacles to be overcome, although this district is in advance of neighboring colonies in these respects.

FRENCH EQUATORIAL AFRICA. Oubanghi, still in its infancy as a coffee-growing country, is the principal producer in this big colony. Exports have increased from

900 bags in 1930 to an estimated 10,000 in 1934.

FRENCH INDO-CHINA. Coffee culture in French Indo-China is a comparatively small factor in international trade, although production is on the increase, particularly from those plantations planted to *robusta*, *liberica*, and *excelsa* varieties. The average annual export for the five-year period ended with 1934 was 540,962 pounds, practically all of it going to France.

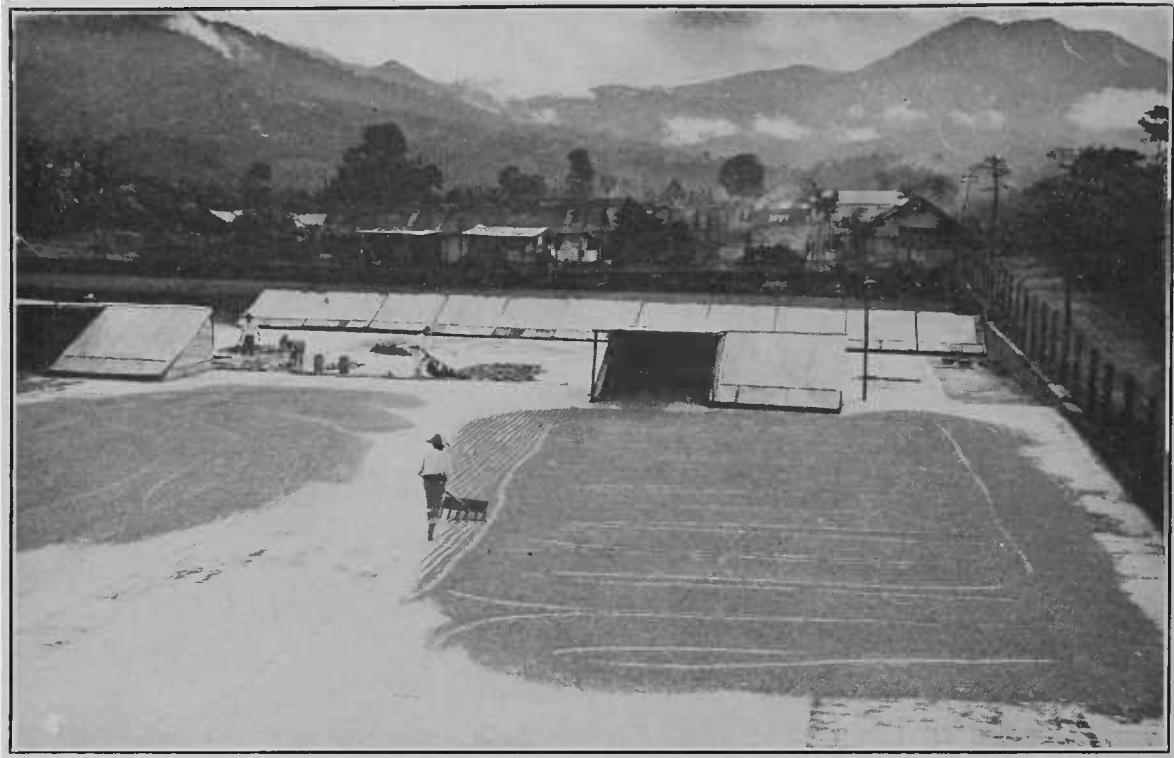
The first experiments with coffee growing were begun in 1887, near Hanoi in Tonkin. The seeds were of the *arabica* variety, brought from Réunion, and the production from the first years was distributed throughout the country to foster the industry. Eventually *arabica* was found unsuitable to the soil and climate, and experiments were begun with *robusta* and other hardier types.

A survey of the industry of the country in 1916 showed that the plant was being successfully grown in the provinces of Tonkin, Annam, and Cochin-China, and that altogether there were about 1,000,000 trees in bearing. The plantations are mostly in the foot-hills of the mountain ranges or on the slopes, although a few are located



ROBUSTA COFFEE GROWING ON THE SUZANNAH ESTATE, COCHIN-CHINA





RAKING COFFEE ON DRYING FLOORS, CHUVA DISTRICT



ENTRANCE TO A FINCA IN THE HIGHLANDS  
COFFEE CULTURE AND PREPARATION IN GUATEMALA



near the coast-line at 1,000 feet, or even less, above sea-level.

The larger and more successful plantations follow advanced methods of planting and cultivating, while the government maintains experimental stations for the purpose of fostering the industry. It is believed that French Indo-China in coming years will assume an important position in the coffee trade of the world, particularly as a source of supply for France. Production has increased somewhat, but the exports remain stationary because the Annamites are consuming more coffee themselves.

**FRENCH WEST AFRICA.** The most important coffee-producing district is the Ivory Coast, from which some *excelsa* coffee planted in 1929 is beginning to yield. There is a small production also in the other colonies, Dahomey and Guinea. French West African coffee exports are being stepped up rapidly; from 7,416 bags exported in 1930, exports rose to an estimated 43,350 bags in 1934. However, the colony has little organization, roads are few, and European colonists insufficient in number; pulping machinery is non-existent and labor difficult to obtain.

**GAUDELLOUPE** has a comparatively small coffee industry, producing excellent quality. A cyclone in 1928 cut down production to a level from which it has not yet recovered. Exports average in the neighborhood of 5,000 bags.

**GUATEMALA** began intensive coffee growing after 1860. Coffee had been known in the country in a small way from about 1850, but in 1875 serious attention began to be given to its cultivation, and it quickly became the great staple crop of the country.

Three mountain ranges, intersecting magnificent table lands, traverse Guatemala from north to south; and there lies the great coffee territory. The table lands are from 2,500 to 5,000 feet above sea-level, and have a temperate climate most agreeable to the coffee tree. On the lower heights it is necessary to protect the young trees from the extreme heat of the sun; and the banana is most approved for this purpose, since it raises its own crop at the same time that it is giving shade to its companion trees. On the higher levels the plantations need protection from the cold north winds that blow strongly across the country, especially in December, January, and



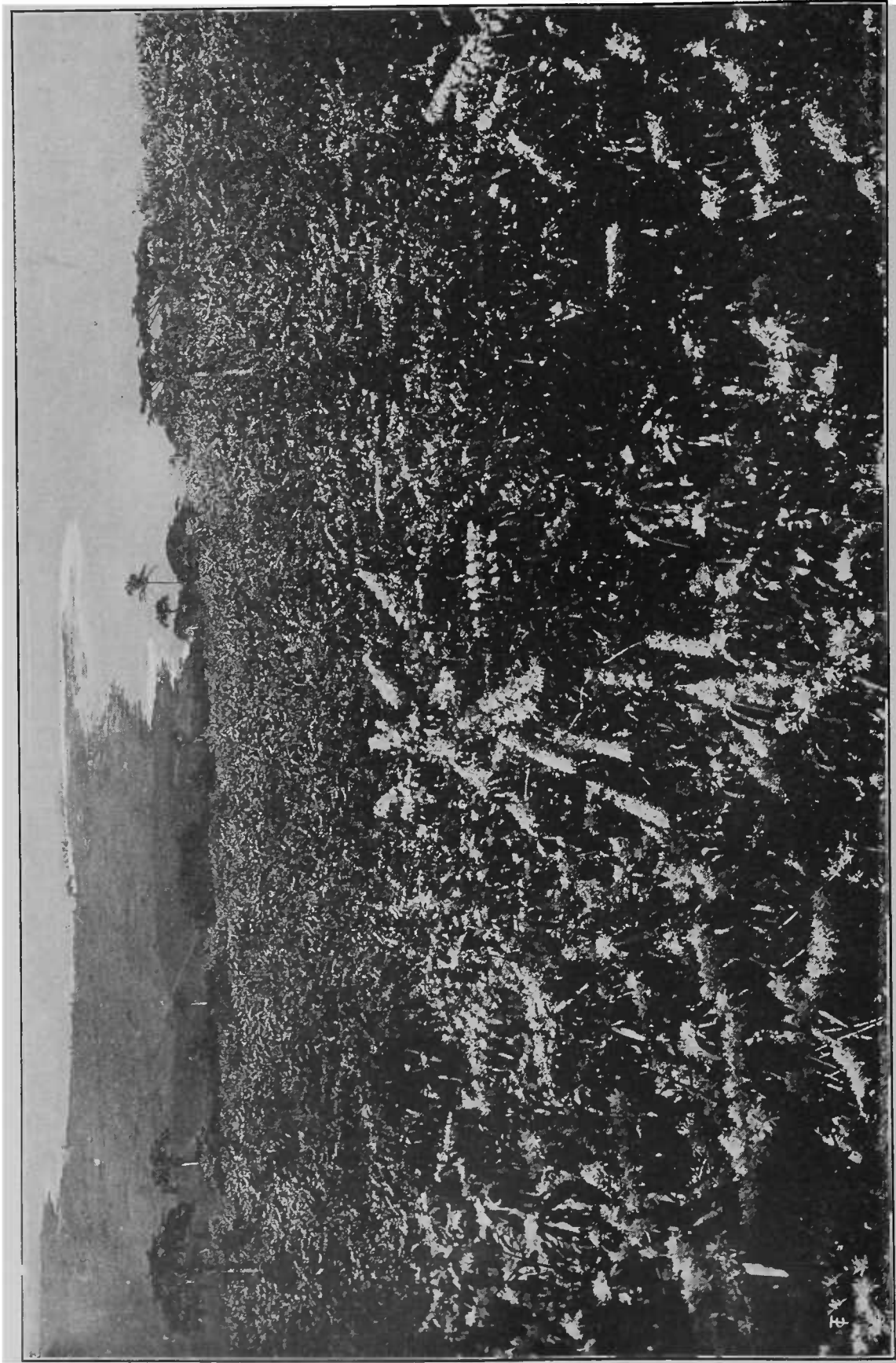
INDIANS PICKING COFFEE, GUATEMALA

February. The range of hills to the north is the best protection, and generally is all-sufficient. When the weather becomes too severe, heaps of rubbish mixed with pitch are thrown up to the north of the fields of coffee trees and set afire, the resultant dense smoke settling down among the trees and protecting them against the frost.

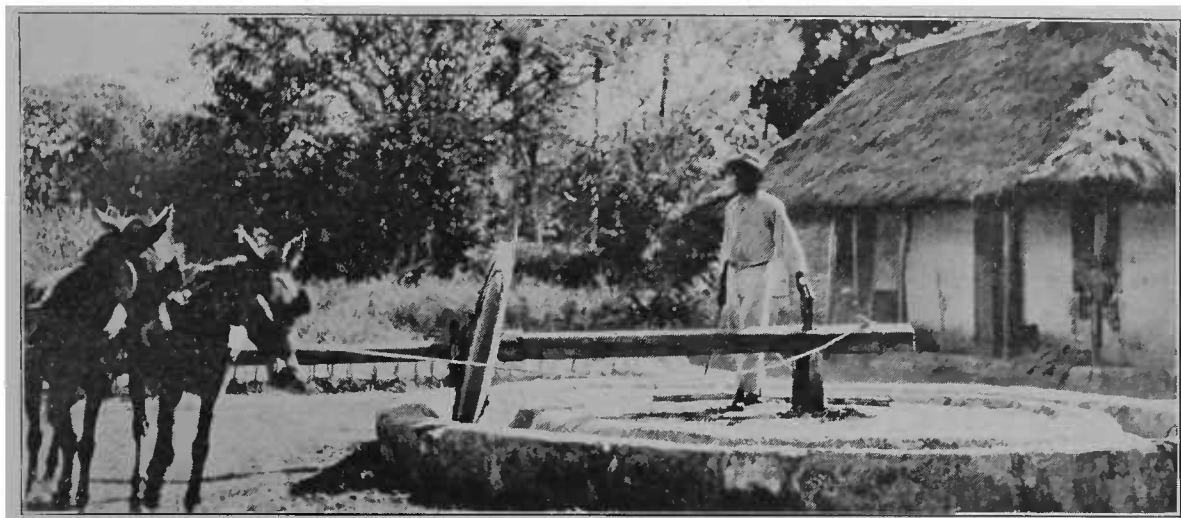
The coffee districts are Costa Cuca, Costa Grande, Barberena, Tumbador, Coban, Costa de Cuevo, Chicacao, Xolhuitz, Pochuta, Malacatan, San Marcos, Chuva, Panan, Turgo, Escuintla, San Vincente, Pacaya, Antigua, Moran, Amatitlan, Sumatan, Palmar, Zunil, Motagua, Colomba and Alta Verapaz. The acreage under coffee is approximately 350,000 acres, according to an estimate published by the Guatemala Department of Agriculture in 1933. There are 120,000,000 trees from which an annual crop averaging about 100,000,000 pounds is raised.

Planting and cultivation methods in Guatemala are about the same as those prevailing in other countries. On the lower estates in Guatemala the crop begins in September and ends in December. On the estates of medium altitude it is begun in October and lasts until January, and on the higher properties from December to May.

As in other coffee-producing countries,



COFFEE IN BLOSSOM, CAPTAIN COOK COFFEE COMPANY ESTATE, KEALAKEKUA, KONA, HAWAII



A MULE-POWER COFFEE HULLER, HAITI

two distinct methods of preparing the coffee beans are followed—the wet and the dry. Nature has given Guatemala an abundance of water, and the coffee districts, especially on the Pacific side, are crossed and recrossed by innumerable streams and rivers, which provide amply for irrigation, power, and treatment. Also, some of the larger plantations use waterways and enclosed piping for the transport of cherry coffee from the plantation to the *beneficios*, or mills. All work on the plantation is done by Indian laborers under a peonage system, families working in companies; wages are small, but sufficient, conditions of living being easy.

About 50 to 55 per cent of the total coffee produced is grown by Germans and between 40 and 60 per cent of the crop has been going direct to Germany. However, recent restrictions on imports of coffee by the German Government have practically closed this market.

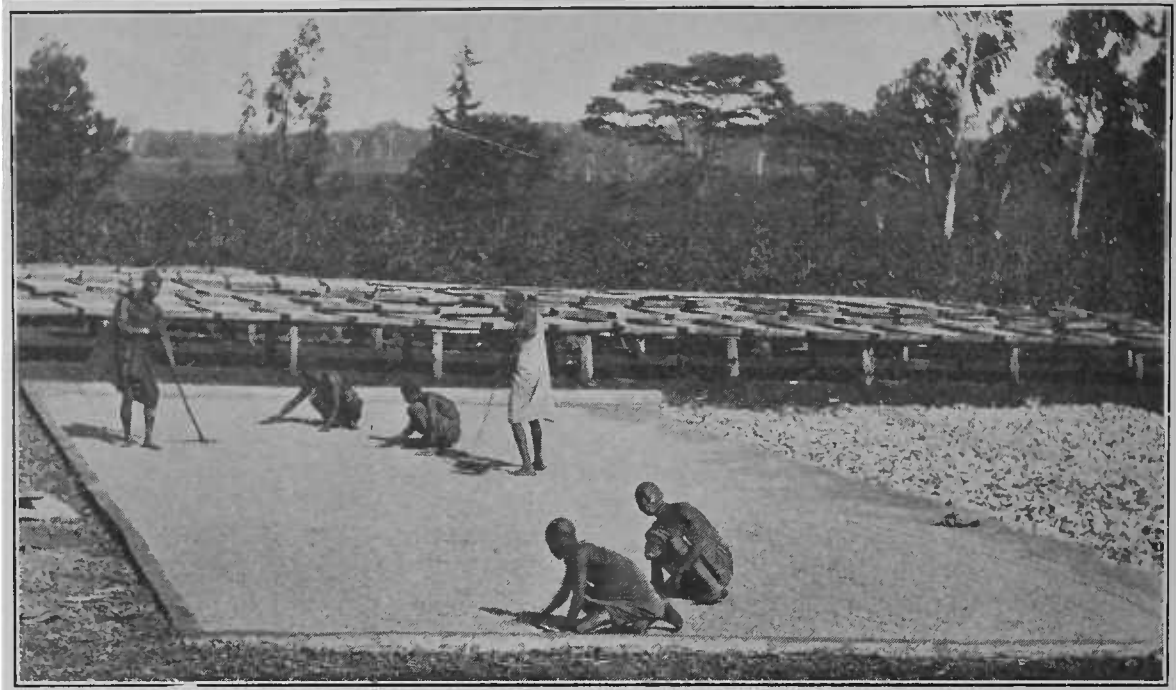
**THE GUIANAS.** Coffee has had a precarious existence in the Guianas. Plants are said to have been brought by Dutch voyagers from Amsterdam in 1718 or 1720. They flourished in the new habitat and, in 1752, were carried from Dutch Guiana into the district of Berbice in British Guiana and into French Guiana. There the berry was a considerable success for a time; Berbice coffee, especially, acquiring a good reputation; and when Demerara was settled, coffee became a staple of that region. Shortage of native labor, and the difficulty of procuring cheap and capable workers from outside the country, ultimately compelled the practical abandonment of the crop in

all three sections, Dutch, French, and British. In British Guiana it is now grown mainly for domestic consumption, and the same is true of French Guiana, which also imports.

From the time of its introduction, about 1718, until about 1880, the only coffee grown in Surinam, or Dutch Guiana, was the *Coffee arabica*. It was not a bountiful producer, and with labor scarce and unreliable, its cultivation was expensive. Therefore experiment was made with the *liberica* plant. This proved to be most satisfactory, growing luxuriantly, producing abundantly, and requiring minimum labor. Planting of *liberica* has gone on apace until it supplies the main agricultural crop.

HAITI has grown coffee almost from the date of its introduction into the Western World. The first cultivation there occurred in 1715. Its primary importance in the economic life of the island is strikingly illustrated by the fact that it constitutes about 75 per cent of Haiti's total export trade. Practically the entire crop is grown on farms of less than 10 acres, by peasant farmers without capital or knowledge of cultivation methods. In the days of the French regime there were several thousand coffee plantations in the colony, but after the evacuation these plantations were split up into small farms, and only remnants of the old colonial plantations compose today the principal producing areas. Both the wet and the dry methods of preparation are used.

Haitian coffee, although not always carefully prepared, has a rich and agreeable aroma. The bean is blue-green and turns



COFFEE DRYING BARBEQUE WITH TRAYS IN BACKGROUND, KENYA

out well in the roast. Approximately 65 per cent of the total exports go to the Le Havre market. Denmark and Belgium are the next best buyers, taking around 10 per cent.

**HAWAII.** Coffee has been grown in Hawaii since 1825, from plants brought from Brazil. It has also been said that seed was brought by Vancouver, the British navigator, on his Pacific exploration voyage, 1791-94. Not, however, until 1845 was an official record made of the crop, which was then 248 pounds. The first plantations, started on the low levels, near the sea, did not do well; and it was not until the trees were planted at elevations of from 1,000 to 3,000 feet above sea-level that better returns were obtained. Some coffee is grown on all the islands of the group, but the entire export crop is produced on the island of Hawaii. The coffee districts are Kona and Hamakua. About 90 per cent of the total output is produced in Kona.

It has been estimated that more than 250,000 acres of land in the Hawaiian group are favorably situated for coffee cultivation, with an additional 100,000 acres of fair quality. At the present time the total acreage under coffee is about 5,500, of which 5,000 acres are in Kona and 500 in Hamakua. Over half of the area planted in coffee produces about 2,200 pounds per

acre and about 10 per cent of the area produces 3,500 pounds per acre.

Yields have been heavily increased by manuring and about 1,000 acres have been planted in coffee on abandoned sugar-cane land and old abandoned coffee fields since the Brazil valorization scheme of 1921 was launched. Within the period from 1921 to 1935 Hawaiian coffee production has practically doubled.

The coffee lands are divided into 5 to



PICKING BLUE MOUNTAIN BERRIES, JAMAICA



7-acre plantations, each in charge of a family. Cultivation is wholly by hand-hoeing, and clean weeding between the trees is the rule. Pruning is done with sickles, light axes, pruning shears, and saws. Fertilizer is applied by hand, and the coffee cherries, after picking, are transported in bags on donkeys to the pulping machine. Most of the farmers own small pulpers, run by gas engines. After the cherries are pulped, the beans are fermented, washed, and dried. Only the wet method of preparation is used. The dried parchment coffee is sold to large factories which remove the parchment and silver skins. Then the beans are graded, bagged, and shipped to San Francisco, Europe, and the Philippines.

**HONDURAS.** Soil, surface, and climate in Honduras, as far as they relate to the cultivation of coffee, are similar to those of the adjoining regions of Central America. The tree grows in the uplands of the interior, thriving best at an altitude of from 1,500 to 4,000 feet. Scarcity of labor and insufficient means of transportation have been the chief obstacles in the way of the large development of the industry. Modern plantation machinery is not used to any extent.

The departments of Santa Barbara,



NATIVE PICKING COFFEE, KENYA

Copan, Cortez, La Paz, Choluteca, and El Paraiso have the principal plantations. The ports of shipment are Truxillo and Puerto Cortes.

Approximately 75 per cent of the total exports go to European countries, and the remainder to the United States.

**JAMAICA.** Coffee was introduced into Jamaica in 1730; and so highly was it regarded as a desirable addition to the agricultural resources of the island, that the



WELL-PRUNED OLD COFFEE UNDER SHADE, KENYA





WASHING COFFEE, KENYA

British Parliament in 1732 passed a special act providing for the encouraging and fostering of its cultivation. Later, it became one of the great staples of the country. Disastrous floods in 1815, and the gradual exhaustion of the best lands, since then, have brought about a decline of the industry, which is now confined to a few estates in the Blue Mountains and to scattered "settler" or peasant cultivation in the same district but at lower altitudes.

The tree was formerly grown at all altitudes, from sea-level to 5,000 feet; but the best height for it is about 4,500 feet. The present coffee area does not exceed 8,000 acres in the famous Blue Mountains. In other parts of the island coffee is produced by peasants on small holdings. The Blue Mountain coffee has the enviable distinction of bringing the highest prices of any coffee in the world.

**KENYA.** Few new coffee enterprises have made such rapid progress as the coffee industry of Kenya. The earliest experimental planting occurred in 1896. Commercial planting was not begun until 1900, but by 1914 there were 6,000 acres under coffee, and this had increased to 102,000 acres in 1934.

The principal coffee-growing areas are: the Kiambu district, immediately north of

Nairobi, where 50 per cent of Kenya's coffee is raised; the Fort Hall district, lying north of the Kiambu area, and accounting for 25 per cent of the Kenya coffee production; and the Lake district, bordering Lake Victoria Nyanza on the east, accounting for about 13 per cent. The remaining 12 per cent is raised in areas scattered about the Colony, wherever the altitude and soil are suitable.

The coffee districts (see Complete Reference Table, Chap. XIX) are located in the highlands at altitudes varying from 4,000 to 7,000 feet. The climate is temperate, and most of the rainfall through the coffee districts occurs in two distinct periods known locally as the "long" and "short" rains. The long rains begin about the end of March and continue through April and May. The short rains commence in October and continue until the end of November. The total annual rainfall varies from 30 to 70 inches, depending on the location. The hottest and driest months are from December to March.

The soils on which most of the coffee plantations are located are volcanic in origin and of varying color and texture, but the best soil is a chocolate-colored loam of great depth.

The principal pest is the "coffee bug," *Antestia variegata*, which has been the subject of considerable investigation, and several methods of control have come to be practised. The chief methods used are hand-picking, poison baiting, and pyrethrum-extract spraying.

Kenya coffee, as a general rule, is picked ripe, pulped, fermented, washed, dried, and graded. The marketing center is Nairobi, the capital, and Mombasa is the seaport. London is the chief market for Kenya coffee, and it is becoming increasingly popular there as a high grade mild. Also the United States and Canada are being developed as additional outlets for these fine coffees through the joint efforts of the Coffee Board of Kenya, representing the growers, and the Coffee Trade Association of Kenya, representing the buyers. Both of these associations have their headquarters in Nairobi.

**LIBERIA.** Coffee is indigenous to Liberia, growing wild throughout the hinterland. Cultivated Liberia coffee, *Coffea liberica*, is grown near the seacoast, in hot, moist lowlands, at low altitudes, by so-called Americo-Liberians — in contra-distinction



MOUNTAIN-SIDE COFFEE PLANTATION, WITH FACTORY AND DRYING TERRACES, MEXICO

to the native tribesmen of the hinterland, who take no part in the industry. A few of the larger plantations, owned by Government officials or ex-officials, have cement drying terraces, but all hulling and cleaning is done by hand. Most of the Liberian exports go to Hamburg or Liverpool, where a small portion is used for blending and the balance is shipped to Scandinavian countries.

MADAGASCAR is the main producer of coffee in the French possessions. The principal varieties raised are the *quillou* and *robusta*, of the *canephora* group. *Liberica* is used to a lesser extent. Earlier plantings of *Coffea arabica* were swept away at the end of the last century by the wave of *Hemileia vastatrix*, the leaf scourge which made *arabica* disappear from all the coasts of the Indian Ocean. The last of the *arabica* had not entirely vanished, however, before attempts were made at replacing it with the Liberia coffee tree. Early hopes were somewhat dampened by the low market prices realized for the product, and Madagascar coffee acquired a bad reputation. The lack of market, aggravated by the high cost of transportation, brought about a reaction which resulted in experiments with the other varieties mentioned. The French preferential tariff

has resulted in a rapid expansion of production in recent years, and corresponding loss of French markets to non-colonial coffees.

MARTINIQUE. This is a name well known to coffee men, the world over, as the pioneer coffee-growing country of the western



C. H. Stewart.

MEXICAN COFFEE PICKER, COATEPEC DISTRICT



C. H. Stewart.

THIRTY-YEAR-OLD COFFEE TREES, LA ESPERANZA, HUATUSCO, MEXICO

hemisphere. Gabriel de Clieu introduced the coffee plant to the island in 1723 by bringing it through many hardships from France. For a time, coffee flourished there; but now practically none is grown. Such coffee as bears the name Martinique in modern trade centers is produced in Guadeloupe, and is only shipped through Martinique.

MEXICO. Coffee was introduced into Mexico from the West Indies near the end of the eighteenth century. A story is current that a Spaniard set out a few trees, on trial, in southern Mexico, in 1790, and that his experiments started other Mexican planters along the same line. Coffee was grown in the state of Vera Cruz early in the nineteenth century.

In the Coatepec district, which eventually became famous, the trees were planted about the year 1808. Local history says that seeds were brought from Cuba by Arias, a partner in the house of Pedro Lopez, owners of the large hacienda of Orduña near Coatepec. The seeds were given to a priest, Andres Dominguez, who sowed them near Teocelo. When he had succeeded in starting the seedlings, he gave them away to other planters who grew them successfully.

It was however, nearly ten years later

before the cultivation was on a scale approaching industrial and commercial importance. About 1816 or 1818 a Spaniard, named Juan Antonio Gomez, introduced the plant into the neighborhood of Cordoba, 2,500 feet above sea-level, in the most productive tropical region of the country.

The industry was centered for a long time in the State of Vera Cruz. For many years practically all the coffee grown commercially in Mexico was produced in that state. Gradually the new cultivation spread to the mountains in the adjacent states of Oaxaca and Puebla, where it was taken up by the Indians almost entirely, and is still followed by them, but not on a large scale.

Although cultivation is now widely distributed in most of the more southern states of the republic, the principal coffee territory is still in Vera Cruz, where lie the districts of Cordoba, Orizaba, Huatusco, and Coatepec. In the same region are the Jalapa district, and the mountains of Puebla, where some coffee is grown. Farther south are the Oaxaca districts.

On the mountain slopes of the Pacific Coast planting in the Pluma district of Oaxaca was begun about sixty years ago.

Still further south are the districts of the State of Chiapas.

The newest coffee development in Mexico is in Chiapas. Here, in the Soconusco district, in the Department of the same name, on the Pacific slope of the Sierra Madre, at elevations ranging from 2,000 to 4,000 feet, a fine mild coffee is grown. The district is one of the most prolific in the Republic. It has come up within the last forty years. The region is near the border of Guatemala, and the coffee is held by many to possess some of the quality of the coffee of that country. The influence of Guatemalan methods has been felt also in its cultivation. It is marketed through Tapachula, capital of the Department of Soconusco. Tapachula has an elevation of 500 feet, and is 24 miles from the small port of San Benito on the Pacific Ocean.

There are no insect pests which attack the coffee bushes, leaves, or cherries; and no blights or droughts. Complete crop failure has never been known.

Two principal varieties of coffee are grown in Mexico, a sub-variety of *Coffea arabica* and a variety called "myrtle," which is probably *Coffea maragogipe*. The sub-variety of *Coffea arabica* is the one most generally cultivated. This grows only

from five to nine feet. It flourishes well at different altitudes and in different climates, from the temperate plains of Puebla to the hot, damp, lower lands of Vera Cruz and Oaxaca. The range of elevation for *Coffea arabica* is from 1,500 to 5,000 feet, and it can stand temperatures as low as 45° or as high as 80° F. with plenty of natural humidity or with irrigation in the dry season.

The other variety, the *maragogipe*, is widely grown, although not in large quantities. It is distinguished from *arabica* by the larger leaf of the tree and by the smaller corolla of the flower. It is a hardier plant than the *arabica* and will stand the higher temperature of low altitudes, thriving at an elevation of from 500 to 3,000 feet above sea-level. It is cultivated mostly in the Cordoba district.

It is claimed by many that the Mexican coffee of best quality is grown in the western regions of the table lands of Colima and Michoacan, but only a small quantity is available for export. The state of Michoacan is especially favored by climate, altitude, soil, and surroundings to produce coffee of exceptionally high grade, and Uruapan is considered to be its best.

Trees flower in January and March, and

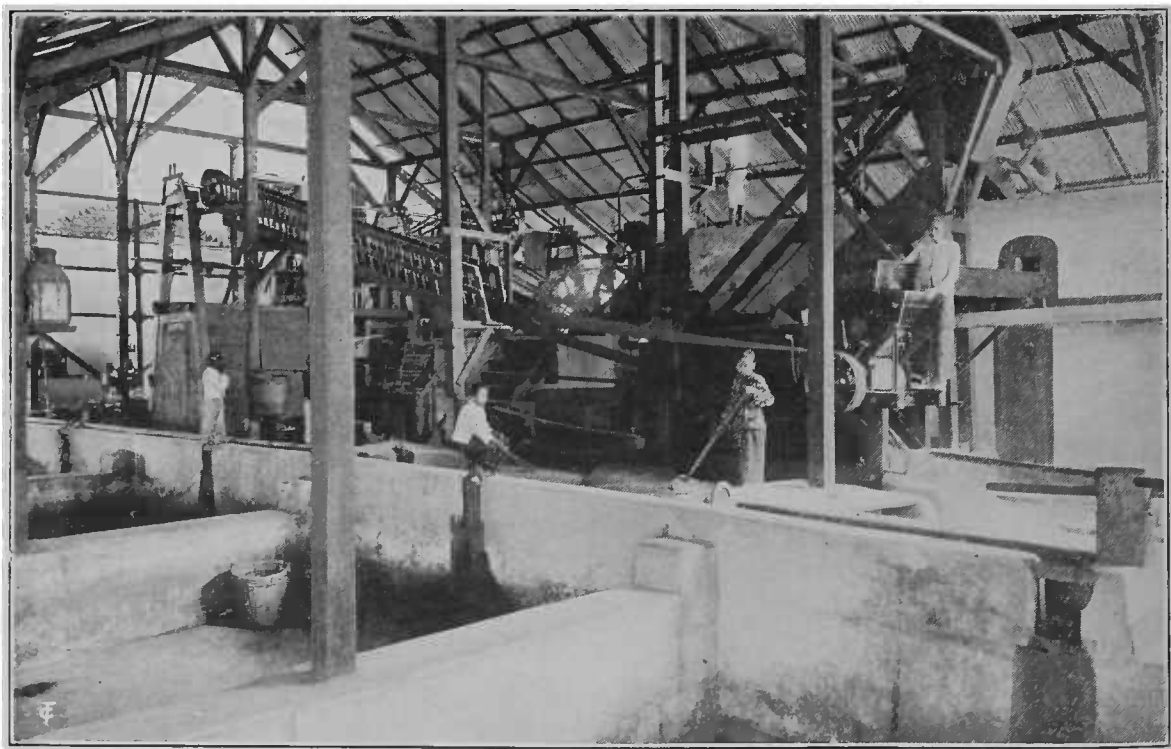


C. H. Stewart  
RECEIVING AND MEASURING THE RIPE BERRIES FROM THE PICKERS, MEXICO





**OPEN-AIR DRYING GROUNDS ON A WEST JAVA ESTATE**  
The beans are being turned by native Sundanese men and women



**INTERIOR OF A MODERN COFFEE FACTORY IN EAST JAVA**  
Showing pulping machinery and fermentation tanks  
**PREPARING JAVA COFFEE FOR THE MARKET**





A HEAVY FRUITING OF COFFEA ROBUSTA IN JAVA

in high altitudes as late as June or July. Berries appear in July and are ripe for gathering in October or November. The picking season lasts until February-March.

Trees begin to yield when two or three years old, producing from two to four ounces. They reach full production, which is about one and a half pounds, at the age of six or seven years, though in the districts of Chiapas, Michoacan, Oaxaca, and Puebla, annual yields of three to five pounds per tree have been reported.

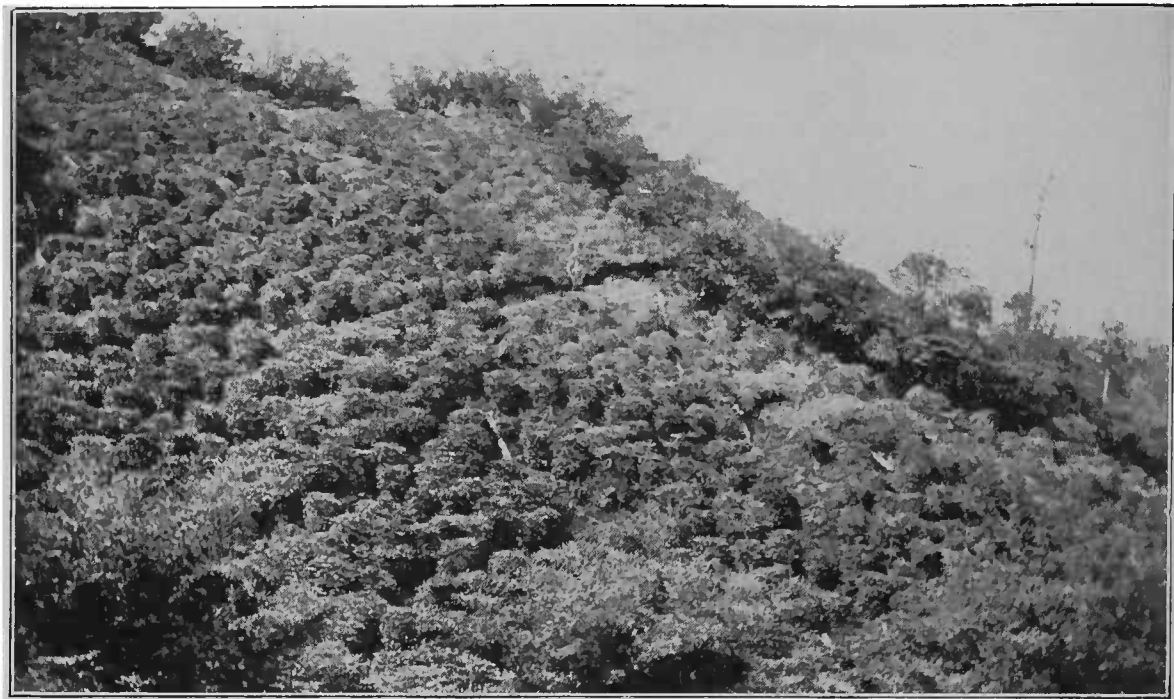
In Mexico coffee is harvested from October to February-March, and large quantities are prepared by both the dry and the wet methods, the latter being practised on the larger estates that have the necessary water supply and can afford the machinery. In Mexico, also, one will find coffee still being cleaned by the primitive hand-mortar and wind-winnowing method on the smaller *fincas*. Laborers are mostly half-breeds and Indians.

**MALAYA.** Under Governmental encouragement to diversify Malaya's commercial productivity, a comparatively small amount of low-grade coffee is raised and consumed locally. The principal areas devoted to coffee planting are in the Federated Malay State of Selangor and the Unfederated State of Johore. The total acre-

age is 19,000. Experiments with the planting of certain strains of *arabica* are being continued in the Cameron Highlands, although earlier attempts, started in 1928, were interrupted by attacks of *Hemileia* in 1932. *Coffea liberica*, however, thrives on the lower lands and yields well when properly cared for.

**NETHERLANDS INDIES.** The earliest introduction of coffee cultivation into the Netherlands Indies occurred toward the end of the seventeenth century, when plants were brought from the coast of Malabar, Southern India, and planted at Kadawoeng, near Batavia. The plants were soon destroyed by earthquake and flood; and in 1699 Henricus Zwaardecroon brought a second lot of seedlings from Malabar, where the original plants had been brought from Mocha. Soon young seedlings were growing on the estates of Bifara Tjina, Cornelis, Palmerah, Kampong Melajoe, and the well-known Soekaboemi and Soedimara estates.

In 1706 the first shipment of coffee grown in the neighborhood of Batavia, with a small growing plant, was sent to the Netherlands East Indies Company at Amsterdam. While the shipment was not large, the original plant, cultivated and multiplied in the Botanical Garden, became the progenitor of the coffees later introduced into the



THE FAMOUS BOEKIT GOMPONG ESTATE, NEAR PADANG, ON SUMATRA'S WEST COAST  
Showing the healthy, regular appearance of well-cultivated coffee bushes, twenty-six years old. Also note the line of feathery bamboo wind-breaks

West Indies and South and Central America.

From the early part of the nineteenth century up to 1905, cultivation was carried on under a Government monopoly, except for a brief period of British control of the island, from 1811 to 1816.

The first monopoly plan required each native to keep 1,000 coffee trees in bearing on village lands, and to give the Government two-fifths of the crop, delivered clean and sorted, at the Government stores. A later modification required each native family to raise and care for 650 trees and to deliver the crop cleaned and sorted to the Government stores at a fixed price. The Government then sold the coffee at public auctions in Batavia, Padang, Amsterdam, and Rotterdam.

This method of fostering the industry resulted in Government control of fully four-fifths of the area under crop, only one-fifth being owned or worked independently by private enterprise. In the course of time, the system of private ownership gradually extended, and before the end of the nineteenth century, private owners were exporting more coffee than the Government. Finally, the Government withdrew from the coffee business in Java in 1905 and in Sumatra in 1908.

Until 1875 *Coffea arabica* was practically the only variety grown in the Netherlands Indies. In that year *Coffea liberica* was introduced from Liberia on the west coast of Africa. This variety was admirably suited to Java soil and steadily displaced *arabica*. The *arabica* variety has practically been driven out of the districts below 3,500 feet altitude by *Hemileia*, and has been succeeded largely by the hardy *robusta* variety, introduced in 1901, and also to a lesser extent by *liberica*. Illustrating the present preponderance of *robusta*, among the varieties raised, out of a total planted area of 95,654 hectares (1 hectare = 2.471 acres) of coffee in Java, there are 89,794 hectares of *robusta*, 4,606 of *arabica*, and 800 of *liberica*. The native coffee culture is practically all *robusta*.

The harvesting of Java coffees runs from July to December, and the best coffees are shipped from July to October.

With climate and soil similar to Java, the island of Sumatra has the advantage that its land is not coffee *moe*, or "coffee tired," as is the case with Java. The principal coffee districts are on the southeast coast, but the west coast, where the plant was first propagated early in the eighteenth century, produces superior quality. Only *robusta* coffee is raised on the south-

east coast. Padang and Sibolga on the west coast are headquarters for Sumatra *arabica* coffee, and Palembang and Telok-Betong are headquarters for *robusta* on the southeast coast.

The total area under coffee in Sumatra is 27,923 hectares, of which 26,096 hectares are planted with *robusta*.

The total area under coffee in all of the islands of the Netherlands Indies is 127,145 hectares, of which 109,382 are in production.

Coffee is grown in several other islands of the Netherlands Indies, chiefly on Celebes, Bali, Lombok, the Moluccas, and Timor. Most of the estates are under native control, and the methods of cultivation are not up to the standard of the European-owned plantations on the larger islands of Java and Sumatra.

NEW CALEDONIA—NEW HEBRIDES, French island colonies in the Pacific, have developed coffee production up to what is estimated to be their limit, at least for a few years. New Caledonia exports have averaged 18,000 bags for the past five years, and New Hebrides, 4,000 bags.

NICARAGUA. Coffee trees will grow well anywhere in Nicaragua, but the best locations have altitudes of from 1,000 to 2,500 feet above sea-level. At such elevations

the yield varies from one pound to two or three pounds per tree annually; but by and large, the average yield per tree in Nicaragua is ten to twelve ounces per annum.

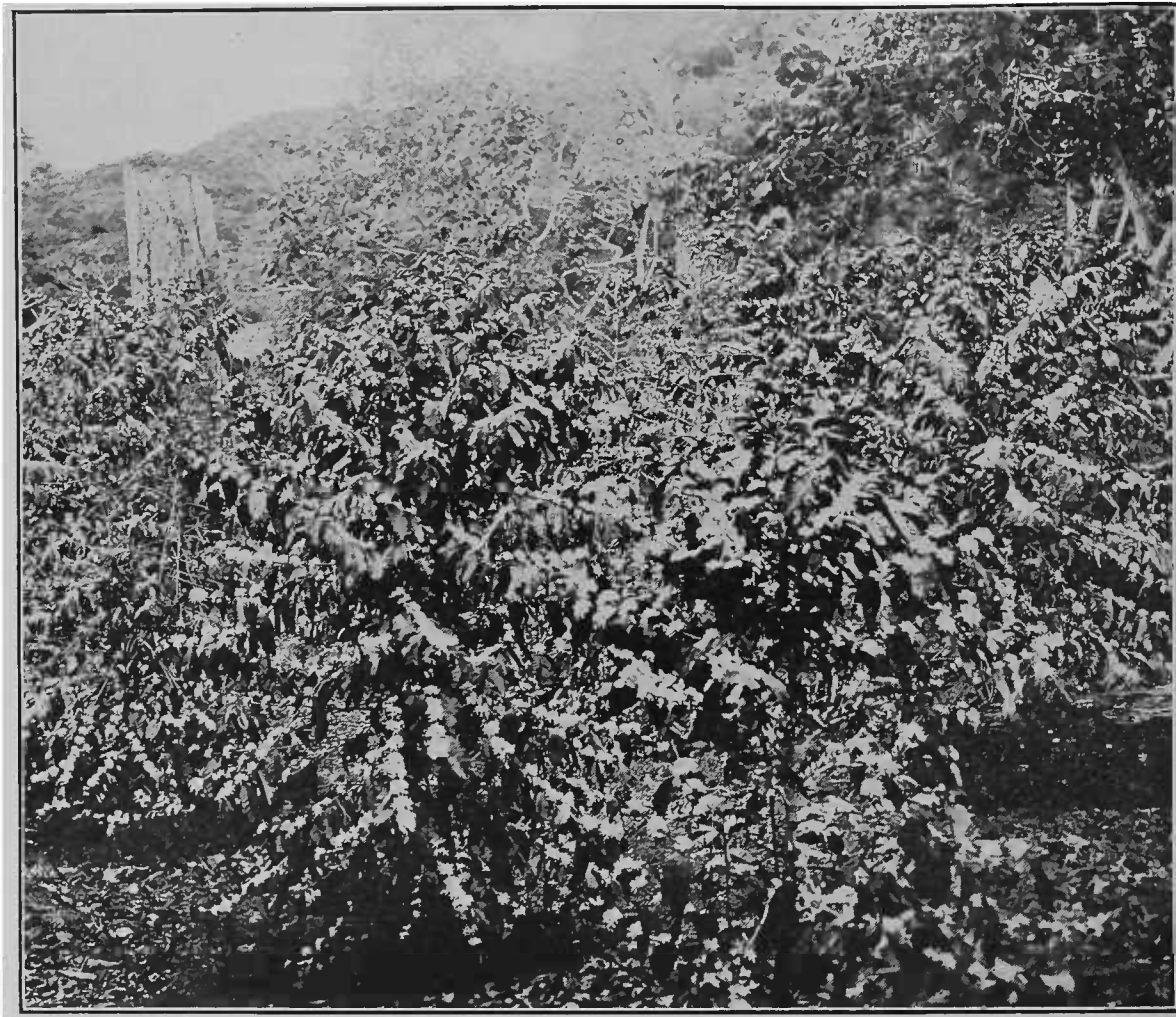
The coffee-producing districts, in the order of their importance are: Managua, Carazo, Matagalpa-Jinotega (one district), and Nueva Segovia. The last-named is unimportant at the present time and will probably remain so until it has had opportunity to recover from the unsettled conditions that have prevailed there for some years. Coffee production in the Chontales region and in the district between Granada and Rivas is insignificant.

Some of the coffee producers are Americans, Germans, Italians, etc., but most of the plantations are owned by Nicaraguans. All of the plantation laborers are Nicaraguans.

Nearly all of the important coffee plantations have installed modern cleaning machinery. The wet and dry methods of preparation are about equally divided. In the Matagalpa region there is plenty of water for the preparation of coffee by the wet method. There is little water in the more important district of Managua, at the time of harvest, so much of the crop must be prepared by the dry process. Furthermore,



Egon Lenz, Managua  
NICARAGUAN COFFEE PLANTATION, WITH DRYING PATIO AND MACHINE HOUSE



THREE-YEAR-OLD COFFEE TREES IN BLOSSOM, PANAMA

in bumper crop years, or in cases where too much of the crop ripens at the same time, the facilities for the wet method are often inadequate and the dry method is necessarily employed. All coffee is exported in 150-lb. bags, except unshelled coffee, *café en pergamino*, which is shipped in bags weighing between 118 and 120 pounds each.

Germany and France are the largest buyers of Nicaraguan coffee, followed in order of importance by the United States, Holland, Spain, Great Britain, Italy, and Finland. Practically all export shipments are made through the Pacific coast port of Corinto, though occasionally small lots are exported through the port of San Juan del Sur. No coffee is exported from Nicaragua's east coast.

The railway line, starting at Granada and going through the cities of Managua and Leon, has a spur extension onto the

wharves at Corinto, where coffee is loaded from the railway cars directly onto the ship tied alongside.

NYASALAND. A few coffee plants introduced into the Protectorate from Edinburgh in 1878 established what became a flourishing industry in the Mlanje district by the year 1891. Coffee was the first European crop in Nyasaland and the prospects of the industry appeared so bright that the symbol of a coffee tree was incorporated in the armorial bearings of the Protectorate. The industry reached its greatest height in 1900 when over two million pounds of coffee were exported and 17,000 acres were under cultivation. A decline which followed has been attributed jointly to failure to maintain the fertility of the soil and to a fall in coffee prices. By 1933 the exports had dropped to 126,000 lbs. and the acreage to 1,210.

Efforts to revive the industry are being



made in the wetter parts of the Shire highlands. *Arabica* is the principal variety.

**PACIFIC ISLANDS.** Islands of the Pacific, with the possible exception of Hawaii and the Philippines, do not loom large in coffee growing, though New Caledonia gives promise as a producer, raising *robusta* mostly. Tahiti produces a fair coffee, but in no commercial quantity. In the Samoan group there are plantations, small in number, in size, and in amount of production. Several islands of the Fiji group are said to be well adapted to coffee, but little is grown there and none for export.

**PANAMA.** Coffee production suffered a serious setback in 1932-33, when the planters found themselves in debt to such an extent that they could not properly clear their plantations and gather the crop. However, the President of the Republic brought about an arrangement with the Banco Nacional whereby the Bank advanced the growers \$5.50 on each quintal of coffee and the remainder of the sale price obtained by the Bank, as selling agent, was divided equally between the growers and their creditors. The outstanding point about this agreement was the elimination of the middlemen.

Panama has many natural advantages

for the growing of coffee. The Boquete district, situated on a continuation of the highlands of Costa Rica into the Panamanian province of Chiriqui has been noted for its high-grade coffees for forty years. Second in importance, although smaller in planted acreage, is the Volcan district, having about the same elevation and producing coffee of about the same quality. Other districts producing coffee of inferior grade, and prepared as a rule in more primitive manner, are adjacent to the towns of La Pintada and El Valle in the Province of Cocle; Calobre, Las Palmas, San Francisco, and Santa Fe, in the Province of Veraguas; and Las Minas in the Province of Herrera, near the port of Chitre.

**PARAGUAY'S** coffee production has no commercial importance, and supplies only a small part of the local consumption. In the eighteenth century the cultivation of coffee was a flourishing industry in the part of the country known as the Missions, but it was practically abandoned after 1767, when the Jesuits were expelled. A century later, new efforts were made to introduce varieties adapted to the climate and soil, resulting in the present rather unimportant industry.



COFFEE PLANTATION NEAR SAGADA, BONTOC PROVINCE, PHILIPPINE ISLANDS





COFFEE GROWING UNDER SHADE, PUERTO RICO

The principal variety now grown is known as *Moka*, which appears to have been introduced from the Yungas of Bolivia in past centuries. Santos is also grown to a smaller extent. The work of cultivation and preparation is practically all done by hand. Frost damage is frequent, as the coffee-producing districts lie well within the frost belt. Add to this the fact that Paraguay is not a coffee-consuming country, and the reason for the backwardness of the industry is more readily understood.

**PERU.** Although possessed of natural coffee land and climate, little has been done to develop the industry. Most of the coffees produced come from the interior mountain region, particularly the Chanchamayo Valley in the Department of Junin and in the Department of Huanuco. Other producing regions are in the Departments of Amazonas and Loreto, located in the trans-Andean region. A small quantity is produced in Pacasmayo, Department of Libertad, in the coastal region. A variety of coffee known as *caracobilló*, and in great demand locally, is produced in the Chanchamayo region.

**PHILIPPINE ISLANDS.** Spanish missionaries from Mexico are said to have carried

the coffee plant to the Philippine Islands in the latter part of the eighteenth century. At first it was cultivated in the province of La Laguna; but afterward other provinces, notably Batangas and Cavité, took it up; and in a short time the industry was one of the most important in the islands. The coffee was of the *arabica* variety. In the middle of the eighteenth century, and after, the industry had a position of importance; several provinces produced profitable crops that contributed much to the wealth of the communities where the berry was cultivated. In those days the city of Yipa was an important trading center. In the period of its prime Philippine coffee enjoyed fine repute, especially in Spain, Great Britain, and China (at Hong Kong), those three countries being the largest consumers. At one time—in 1883 and 1884—the annual export was 16,000,000 pounds, which demonstrates the importance of the industry at the peak of its prosperity. Leaf blight appeared on the island about 1889, causing destruction from which there has not yet been complete recovery. The export of only 882 pounds, in 1933, shows the depths into which the industry has fallen.

Despite the misfortunes that have over-

whelmed it in the past and are now regarding its growth, it is still believed that the industry may be rehabilitated. Conditions of soil and climate are favorable; land and labor are cheap, abundant, and dependable; railroads run into the best coffee regions, and good cart roads are in process of construction.

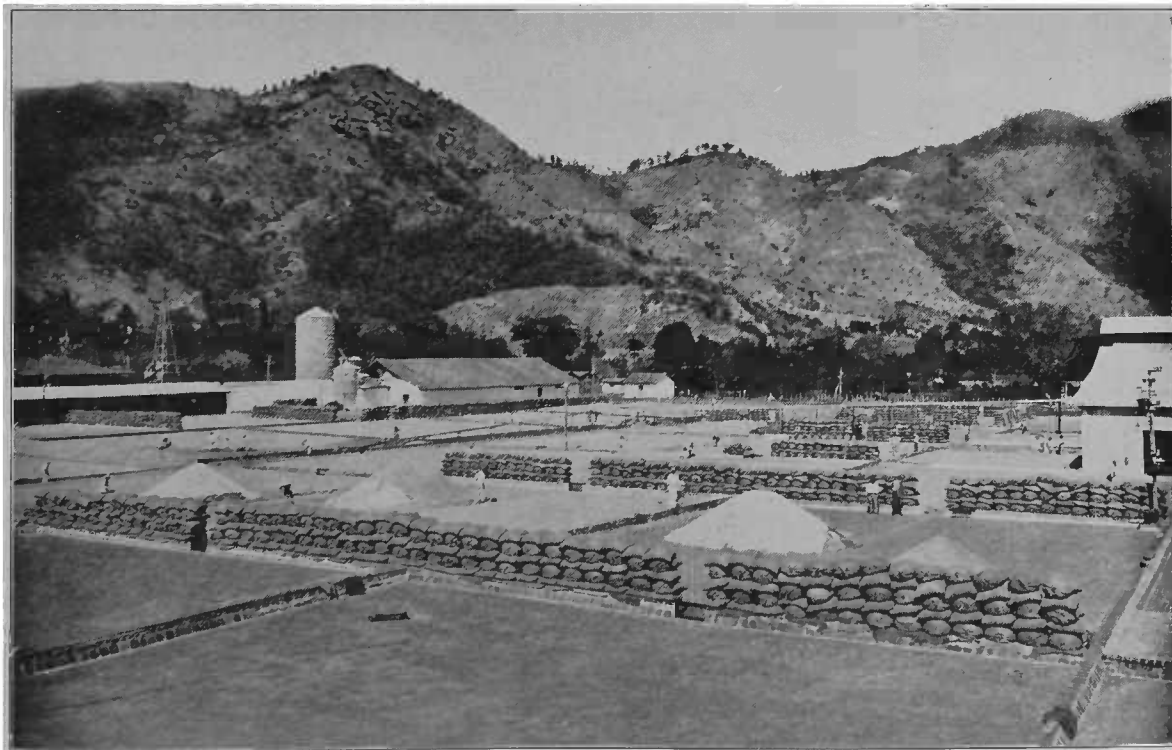
**PUERTO RICO.** The coffee-growing region is in the central mountainous district at an altitude of from 800 to 2,500 feet and produces but one crop a year. There are about 180,000 acres planted to coffee. Picking begins in August and continues through September, October, and November. Planters favor the wet method of coffee preparation. Prior to the hurricane of 1928, which badly disorganized the industry, Puerto Rico's average annual production was approximately 42,000,000 pounds. With the island's consumption somewhere around 18,000,000 pounds annually, a considerable quantity of coffee was available for export. Since the hurricane, however, the coffee production has been less than the island's consumption requirements, although efforts are being made by the local Department of Agriculture and other institutions to rehabilitate coffee planting. The coffee production of

the island in 1933-34 was 11,200,000 lbs.

Coffee culture in Puerto Rico dates from 1755 or even earlier, having been introduced from the neighboring islands of Martinique and Haiti. Count O'Reilly, writing of the island in the eighteenth century, mentions that the coffee exports for five years previous to 1765 amounted in value to \$2,078. Old records show that in 1770 there was a crop of 700,000 pounds and that seems to be the first evidence that the new industry was growing to any noticeable proportions. For a hundred years at least, only slow progress was made. In 1768 the king of Spain issued a royal decree exempting coffee growers on the island from the payment of taxes or charges for a period of five years; but even that measure was not materially successful in stimulating interest and in developing cultivation.

In years when there was an exportable surplus, Spain was the largest single purchaser, followed by Germany and France. Although Puerto Rico is a part of the United States, very little Puerto Rican coffee ever came here, and such shipments as were made to New York, were destined, mostly, for re-export to Europe.

**SALVADOR OR EL SALVADOR.** Coffee is



LAS TRES PUERTAS COFFEE-PREPARING PLANT, SANTA ANA, EL SALVADOR

cultivated in all the Salvadorian districts that have an altitude of from 1,500 to 5,500 feet, the total area under coffee being about 100,000 hectares (1 hectare = 2.471 acres). It was first grown about 1852 by native Indians at Ahuachapán from stock brought in from Guatemala. It was not, however, until 1840 that coffee cultivation was begun in earnest through the efforts of Maestro Antonio J. Coelho. Following that date it took twenty years for the exports of coffee to reach 1 per cent in the value of shipments abroad, but by the turn of the century the proportion of coffee to other exports had reached 80 per cent, and in 1924, 93 per cent—making the country one of the few exporting almost exclusively a single commodity. The coffee industry is owned for the greater part by nationals of El Salvador who have given their best thought and efforts to its development. The laborers are almost entirely native Indians. A considerable part of the work is done by hand but, in recent years, many of the large estates have installed machinery, which is also used in the receiving centers.

The most productive coffee plantations are located in the departments of La Paz, Santa Ana, Sonsonate, San Salvador, San Vicente, San Miguel, Santa Tecla, and Ahuachapán.

**SOUTHERN INDIA.** The coffee industry of Southern India produces about 20,000 long tons of coffee annually, which is only a "drop in the ocean," in comparison with the world's supply, but the producers take their stand on quality and care in preparation. Three-quarters of the quantity is produced in the native state of Mysore and the province of Coorg, with Mysore predominating heavily. The remainder comes from the following districts, in the order of their importance: the Nilgiri, Shevaroy, Anamallai, Pulney, Nelliampathy, Billigirirangan, and Kanan Devan Hills.

The first coffee seeds were brought from Mecca to Southern India, in the seventeenth century by a Moslem pilgrim named Baba Budan, according to tradition. They were planted near a temple on a hill in Mysore named after the pilgrim, and from there the cultivation gradually spread to neighboring districts.

Since 1896, when approximately 304,000 acres were under coffee in Southern India, there has been a considerable decrease in area. In the crop year 1919-20 the total

acreage was 116,411, but in the following fourteen years there was an increase of 60,000 acres, or about 50 per cent over 1920. The original decrease was caused by leaf disease, which wiped out large areas of coffee. However, the growing of coffee under shade was found to decrease the severity of leaf-disease attacks, and all coffee is now grown under fairly heavy shade. During 1907 the green bug also made its appearance, devastating large areas.

During the past decade all progressive estates spray the coffee once and sometimes twice a year with Bordeaux and Burgundy mixtures, as a preventive measure, and this has proved quite successful.

Yield varies throughout the country. On the best estates in a good season the yield may be as high as 1,200 pounds per acre, and on poor estates it may not be over 200 or 300 pounds. The *arabica* variety is chiefly cultivated. *Robusta* coffee is being grown successfully in parts of Coorg and Mysore where the climate does not suit *arabica*. *Maragogipe* occurs on most estates but is being cut out, owing to poor cropping.

A representative plantation is the Santaverre in Mysore, comprising 400 acres, at an elevation of 4,000 to 4,500 feet, where the coffee trees, cultivated under shade produce from 100 to 250 long tons of coffee a year. Other prominent estates in Mysore are Cannon's Baloor and Mylemoney, the Hoshkahn, and the Sumpigay Khan.

South Indian estates are not usually owned by large companies, as is the case with tea, and can, generally speaking, be divided into two classes—those in which the coffee receives intensive cultivation, and those in which it is in an abandoned condition.

Of the total annual production of coffee in Southern India, about 25 to 30 per cent is retained in India for local consumption. The remainder is exported almost exclusively to Europe, Australasia, and the Persian Gulf. Of the total exports approximately 85 per cent go to Europe, with London heading the list of destinations.

The bulk of the Southern India coffee is prepared up to the parchment stage on the estates; that is, it is pulped, washed, and receives a certain amount of drying. However, some coffee from native-owned estates is not washed and leaves the estate in the cherry. From the estate, coffee is



COFFEE GROWING UNDER THE ORIGINAL JUNGLE TREES, UBBAN ESTATE, INDIA

transported down the Ghats by lorry or bullock-cart to the curing establishments which are located on the coast, with the exception of two inland at Coimbatore.

Arrived at the curing works, the coffee is dried, hulled, and automatically sized into grades. After this there is a final hand-picking for the removal of "trriage" and rejections.

Mangalore easily leads in the quantity of coffee exported, followed by Tellicherry and Calicut, in the order of their importance. A recent development (1935) has been the dredging of the harbor at Cochin, 580 miles south of Bombay on the west coast, to make it available as an outlet for Southern India tea and coffee. The center of the coffee trade is Mangalore, where regular auctions are held from December to May.

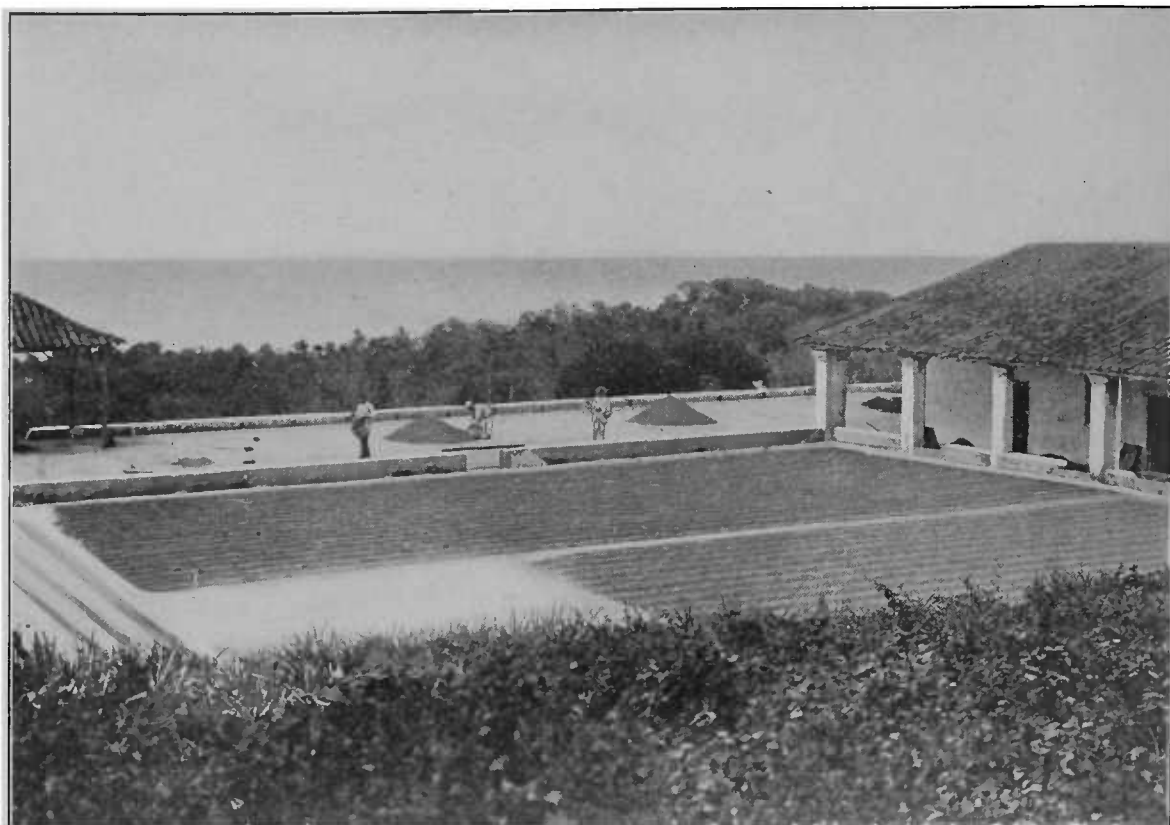
**TRINIDAD AND TOBAGO.** The two islands are small factors in international coffee trading, but raise sufficient coffee for their own consumption, which is around 1,200,000 lbs. annually, and an exportable surplus which averages about 650,000 lbs. a year. Coffee is interplanted on practically all the cocoa estates in the islands. There are no separate coffee estates. The acreage planted to cocoa is reported as 220,000 and it is estimated that coffee occupies about

75 per cent of this acreage. On account of the dual planting the coffee yield is not large. Two varieties of coffee are grown—*arabica* and *robusta*. The *Arabica* is superior in flavor, while the *robusta* is hardier and gives a larger yield, although it brings a lower price.

**TANGANYIKA.** Coffee has first place among the commercial crops of Tanganyika Territory. The most important coffee-producing area is the Bukoba district west of Lake Victoria Nyanza, but some coffee is raised in the northeastern section in the vicinity of Mount Kilimanjaro, although the soil and rainfall of this district is not so well suited to coffee. A comparatively small amount of Tanganyika coffee is exported from the country direct, but the great bulk of it goes to Kenya for re-export. The Bukoba coffee production is almost exclusively in native hands and dates back many years. It is grown on a large number of small holdings among bananas and maize, which are the staple diet of the natives. The production is estimated at about 8,000 long tons, grown by 60,000 native planters.

**UGANDA** is an agricultural country, depending principally on cotton and coffee for its commercial wealth. Cotton constitutes about 80 per cent of the value of





COFFEE DRYING PATIOS, HACIENDA LONGA-ESPANA, VENEZUELA

the exports from the country, followed by coffee, rubber, and tea in the order of their importance. Coffee is grown mostly in the Bunyoro and Busoga districts.

*Robusta* coffee is indigenous to the country and has been grown by natives for many years. *Arabica* was introduced in 1904, but its cultivation is now practically confined to the higher elevations in the Toro and Bugishu districts. *Robusta* is grown at lower altitudes, mainly along the shores of Lake Victoria Nyanza and in Bunyoro. The acreage under coffee is divided approximately as: native, *arabica*, 9,500; *robusta*, 17,000; total 26,500; non-native, *arabica*, 8,000; *robusta*, 6,500; total 14,500.

In Bugishu, where coffee development has been rapid, a scheme has been developed by the Native Administration which provides central pulping stations and a central factory. It aims ultimately at the formation of a cooperative selling society. Bugishu coffee is marketed in bulk after drying, hulling, and grading. The scheme has already borne fruit in relatively higher prices.

*Robusta* cultivation is rapidly increasing, the seed supply being controlled by

the Government, and a coffee-grading ordinance, designed to improve the grade of native-grown *robusta*, having recently been passed. All native-grown coffee has to pass through a licensed curing works before being exported. The main flowering season occurs during the spring rains, and the crop is gathered from September onwards.

Uganda coffee finds its market on the Continent and in America as a medium coffee, although some of the higher-elevation coffees attract buyers in competition with the better East African marks.

VENEZUELA. Coffee production is so important in Venezuela as to warrant her claim to fifth place in the world's production. Seeds of the coffee plant were first brought into Venezuela from Martinique in 1784 by a priest who started a small plantation near Caracas.

Situated between the equator and the twelfth parallel of north latitude, in the world's coffee belt, this country has an area equal to that of all the United States east of the Mississippi river and north of the Ohio and Potomac rivers, or greater than that of France, Germany, and the



Netherlands combined — 393,977 square miles.

The chain of the Maritime Andes, reaching eastward across Colombia and Venezuela, approaches the Caribbean coast in the latter country. Along the slopes and foot-hills of these mountains are produced some of the finest grades of South American coffee. The best coffee grows in the *tierra templada* and in the lower part of the *tierra fria*, and is known as *café de tierra fria*, or coffee of the cold, or high, land. In these regions the equable climate, the constant and adequate moisture, the rich and well-drained soil, and the protecting forest shade afford the conditions under which the plant grows and thrives best. On the fertile lowland valleys nearer the coast grows the *café de tierra caliente*, or coffee of the hot land.

Coffee growing is the main agricultural industry. An estimate made in 1935 places the planted area at 427,310 acres and the number of plantations as approximately 30,000. The total number of coffee trees in the country is estimated at 260,000,000. The yield may be given roughly as 670 lbs. per acre on the best lands; 450 lbs. on good lands; and 270 lbs. on ordinary lands, but varies greatly from an infinity of factors. The trees are planted 1,200 to 1,500 to the hectare (1 hectare = 2.471 acres).

In Venezuela, the coffee tree bears its first crop when four or five years old. The trees are not subject to unusual hazards from the attacks of injurious insects and animals or from serious parasitic

diseases. Nature is kind to them, and their only serious contention for existence arises from the luxuriant tropical vegetation by which they are surrounded. On the whole their cultivation is comparatively easy.

The principal producing States are Tachira, Lara, Mérida, Yaracuy, Aragua, Carabobo, the Federal District, Portuguesa, Miranda, and Falcon.

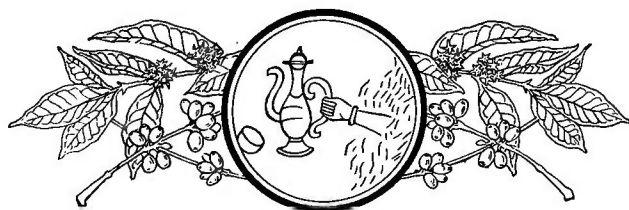
There are no great coffee belts as in Mexico and Central America. Many districts are days' rides apart. The plantations are isolated. A group of the leading coffee producers in Venezuela recently formed the "National Association of Coffee Growers," the objects of which are to improve the quality of coffees grown through the study of scientific methods, and to open up additional foreign markets.

Methods of cultivating and preparing the berry for the market—wet and dry—are substantially those that prevail elsewhere in South America. Most plantations are handled in ordinary, old-fashioned ways; but the better estates employ cleaning machinery and methods of the most advanced and improved character.

Coffee prepared by being dried in the sun—the dry method—is called *trillado*. Washed coffee, however, brings the best price, especially the so-called "blue" quality, which is quite scarce, only about 15,000 bags being produced annually.

The most important districts and ports for the exportation of Venezuelan coffee are Maracaibo, Caracas (through its seaport La Guaira), and Puerto Cabello.

YEMEN. See Arabia.



## CHAPTER XIX

### GREEN AND ROASTED COFFEE CHARACTERISTICS

THE TRADE VALUES, BEAN CHARACTERISTICS, AND CUP MERITS OF THE LEADING COFFEES OF COMMERCE, WITH A COMPLETE REFERENCE TABLE OF THE PRINCIPAL KINDS OF COFFEE GROWN IN THE WORLD—APPEARANCE, AROMA, AND FLAVOR IN CUP-TESTING—HOW EXPERTS TEST COFFEE—A TYPICAL SAMPLE-ROASTING AND CUP-TESTING OUTFIT

**M**ORE than a hundred different kinds of coffee are bought and sold in the world's coffee markets. All of them belong to the same botanical genus, and most of them to the same species, *Coffea arabica*; but each has distinguishing characteristics which determine its commercial value in the eyes of the importers, roasters, and distributors.

The American trade deals almost exclusively in *Coffea arabica*, although increasing quantities of *robusta* and *liberica* growths are imported, largely because of the improvement over former preparation methods, especially in the case of Robustas, and their wider use in blends. Considerable quantities of Robusta grades were sold in the United States before 1912, but trading in them fell off when the New York Coffee and Sugar Exchange prohibited their delivery on Exchange contracts after March 1, 1912. However, because of their increasing popularity for blending purposes and in response to demand, trading in washed Robustas on the Exchange has been permitted since 1925.

Coffees from every country and district vary in bean, roast, and cup. The descriptions given in this chapter and the reference table that follows apply to the coffee of a given district as to the bulk of the output. Variations occur but they are usually of minor commercial importance.

All coffees are divided into two general groups, Brazils and Milds. Brazils comprise coffees grown in São Paulo, Minas Geraes, Rio de Janeiro, Bahia, Paraná, Victoria, and other Brazilian States. The Milds include all coffees grown elsewhere.

In 1934, Brazils made up about 60 per cent of the world's total consumption. They were formerly regarded by American traders as "price" coffees, while Milds, as a group, were considered as "quality" grades, but certain mild growths such as Robustas and Liberians and low-grade Colombians have supplanted Brazils to some extent in the United States and this also applies to Colonial growths in European countries.

Brazil coffees are classified into five great groups, which bear the names of the ports through which they are exported: Santos, Rio, Victoria, Bahia, and Paranagua. In addition, shipments are being made from Recife (Pernambuco) and Angra dos Reis. Santos coffee is grown principally in the State of São Paulo; Rio, in the States of Rio de Janeiro and Minas Geraes; Victoria, in the State of Espírito Santo; Bahia in the State of Bahia; and Paranagua in the State of Paraná. All of these groups are further subdivided according to their bean characteristics and the districts in which they are produced.

#### *Brazil Coffee Characteristics*

**SANTOS.** Santos coffees, considered as a whole, have the distinction of being the best grown in Brazil. Minas coffees rank next; Paranas coming third; Bahias, fourth; Pernambucos, fifth; Rios, sixth; and then Victorias. Of the Santos growths the best is that known in the trade as Bourbon, produced by trees grown from Mocha seed (*Coffea arabica*) brought originally from the French island colony of

Bourbon (now Réunion) in the Indian Ocean.

The Bourbon coffee now grown in Brazil is distinctly a Brazilian plant, as no trees or seeds have been brought from the original source for more than a hundred years; so that if the formerly accepted theory of deterioration of the Bourbon plant after several years' production were true, by now there would be no coffee of true Bourbon character in Brazil. The Brazilian plant has been developed by grafting Brazilian *café branco* with *café murtha*, the latter being a much smaller plant than the coffee trees usually seen in Brazil, and the berry of which resembles Arabian Mocha. The Bourbon tree is smaller than either *café branco* or *café amarelo*, but heavier in foliage and much more productive. All of the species have their champions as to desirability of the plant from the standpoint of production over a period of years, resistance to drought, frost, etc. Likewise care is taken in selecting the species in accordance with the soil of the plantation to be laid out, certain districts being peculiarly adapted to one or the other kind. The Bourbon characteristic of small curly bean may vary from year to year, according to the weather during the growing crop and, indeed, these characteristics may, in certain years, almost disappear.

As regards flavor, a good Bourbon Santos is considered the best coffee for its price, and is the most satisfactory low-cost blending coffee to be obtained. It is used in some cases to reduce the cost of the blend, at the same time improving the quality. When properly made, this coffee produces a drink that is smooth and palatable, without special character, and is suitable to the average taste. When aged, Bourbon Santos decreases in acidity, and increases somewhat in size of bean, the latter change being due to the absorption of moisture while stored in Brazil.

The Santos coffee described as Flat Bean is a larger bean and without the curly characteristics generally noted in Bourbon Santos. It is usually void of acid and has a rather "flat" taste. It is produced in white soil land on trees known as *Café Commun* or *Café Amarelo*. The cup has a good and smooth body of neutral character, and the bean can be used straight or in a blend with practically any mild coffee.



In certain parts of the State of São Paulo, geographically widely separated, the Flat Bean Santos coffee has a distinctly harsh or hard flavor, depending upon whether the plant is of the Bourbon or other species. This undoubtedly is caused by some unknown element in the soil. By careful preparation on the drying grounds during the drying season, the quality is greatly improved; but this coffee is sold at a lower price than strictly soft Santos.

Some trade authorities believe that Santos coffees are an exception to the rule that most green coffees improve with age. They argue that a new crop Santos is to be preferred to an old crop. Opinion differs on this question, however, many insisting that the old crop Santos coffees are superior.

MINAS. The State of Minas Geraes is so large in area that the characteristics of her coffee divide themselves into three separate groups: SUL DE MINAS, which is the part adjacent to the State of São Paulo near the Batataes, Pinhal, and Franca districts, producing coffee of excellent quality, comparable to the best São Paulo coffees; OESTE DE MINAS, or the western and northwestern part of the State, growing coffee similar to São Paulo Bourbon in appearance but generally hard and sour in taste; NORTH MINAS, or the

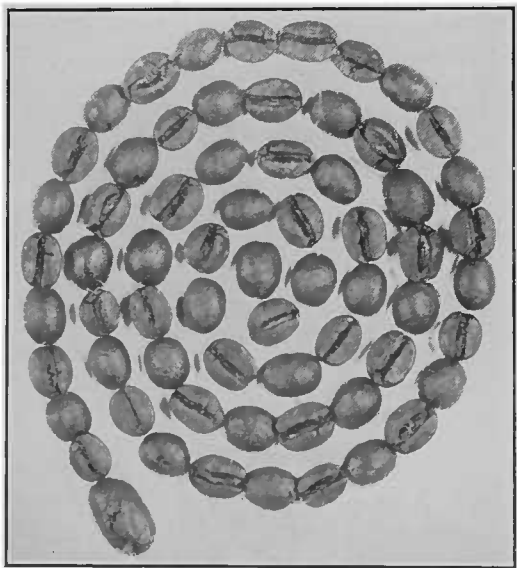
part near the State of Espírito Santo, producing the Victoria type.

**PARANAS.** Paraná is comparatively a new coffee-producing State. Its principal coffee areas are: the CAMBARÁ-JACARIZINHO district, which produces coffee of good quality comparing most favorably with some São Paulo coffees; and the PLATINA-COLONIA MINEIRA district, which produces coffee of poor drinking quality, often with a "groundy" and hard flavor.

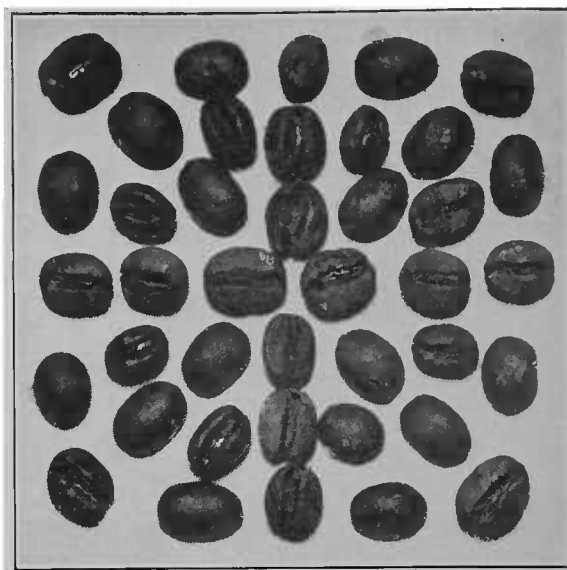
**BAHIAS.** Until recent years Bahia coffee has been decidedly unpopular in the United States, largely because of its peculiar smoky flavor, due to drying the coffee by means of wood fires, instead of by the usual sun method. This practice has been abandoned. Bahia coffee has shown a marked improvement in quality, and importations into the United States have increased. The Bahia coffee produced in the Chapada district is considered to be the best in the State. The bean is light-colored and of fair size. Other types are Caravella and Nazareth, both of which are below the standards demanded by the majority of the American trade.

**PERNAMBUCOS.** A "groundy" or "earthy" taste characterizes most Pernambucos, but some of the better types are of higher quality, comparing favorably with Bahias.

**VICTORIAS.** Up to about the year 1917, Victoria coffees were held in even less favor by American traders than were Rios. As a rule the bean was large and punky, of a dark brown or dingy color, and its



BOURBON SANTOS BEANS—ROASTED

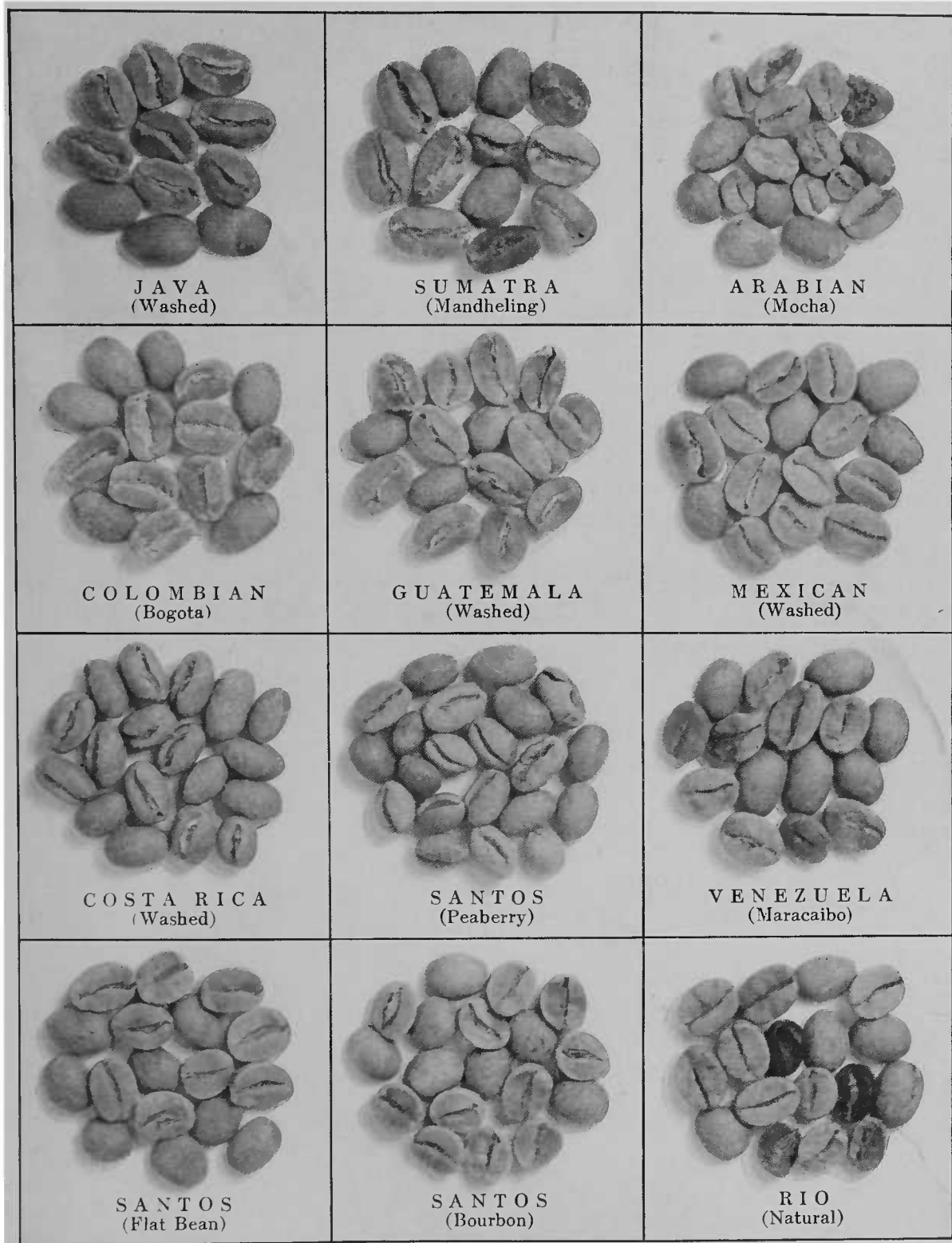


FLAT AND BOURBON SANTOS BEANS—ROASTED

flavor was described as muddy. Then the coffee growers began to introduce modern machinery for handling the crops, with the result that the character of the produce has been much improved, and the demand for it has been steadily growing. Many roasters who formerly used Rios straight for their lower grades, have changed to Victorias, not only to improve the appearance of the roast, but to soften the harsh drinking qualities of the low-grade Rios.

**RIOS.** Rio coffee is not generally liked in the United States, though in former years it had some following even in the better trade. The demand for all grades of Rio has been decreasing, Santos taking its place in the United States, except in the south. Rio coffee has a peculiar, rank flavor and a heavy, harsh taste which traders do not consider of value either in straight coffee or in blends. However, its low price recommends it to some packers, and it is often found in the cheapest brands of package coffees and also in many compounds. In color, the bean runs from light green to dark green; but when it is stored for any length of time—a common practice in the past—the color changes to a golden yellow; and the coffee is then known as golden Rio. The bean also expands with age.

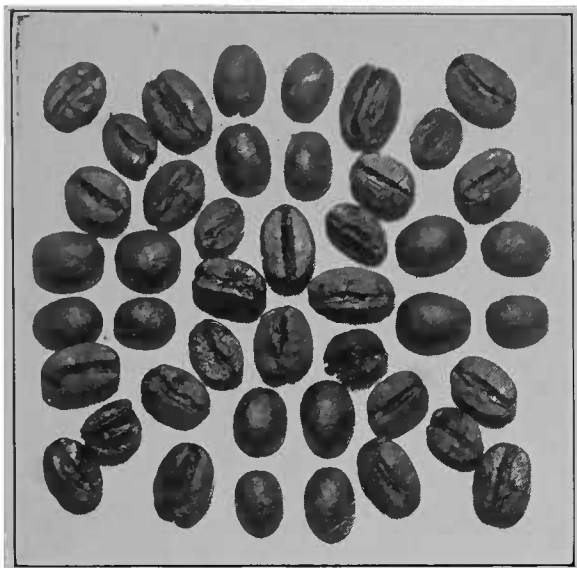
**MARAGOGIPE.** This is a variety of *Coffea arabica* first observed growing near the town of Maragogipe, Bahia, Brazil, where it is called *Coffea indigena*. The green bean is of huge size, and varies in color from green to dingy brown. It is the



- PRINCIPAL VARIETIES OF GREEN COFFEE BEANS  
NATURAL SIZE AND COLOR







RIO BEANS—ROASTED

largest of all coffee beans, and makes an elephantine roast, free from quakers, but woody and generally disagreeable in the cup. However, Dr. P. J. S. Cramer of the Netherlands Government's experimental garden in Bangelan, Java, regards it very highly, referring to it as "the finest coffee known," and as having "a highly developed, splendid flavor." This coffee is now found in practically all the producing countries, and shows the characteristics of the other coffees produced in the same soil.

#### *The Characteristics of Mild Coffees*

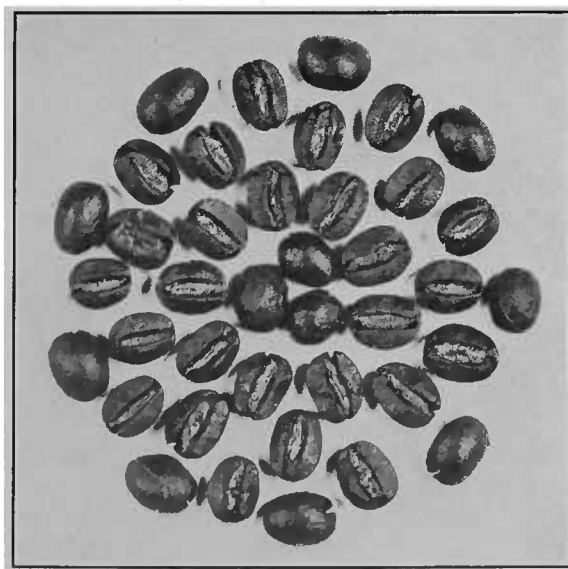
Among the Mild coffees there is a much greater variation in characteristics than is found among the Brazilian growths. This is due to the differences in climate, altitude, and soil, as well as in the cultural, processing, storage, and transportation methods employed in the widely separated countries in which Milds are produced.

Mild coffees generally have more body, more acidity, and a much finer aroma than Brazils; and from the standpoint of quality they are far more desirable in the cup. As a rule they have also better appearance, or "style," both in the green and in the roast, due to greater care in picking and preparing the higher grades; although in recent years there has been a decided improvement in cultivation and preparation in Brazil. Milds are important for blending purposes, most of them possessing distinctive individual characteristics, which increase their value as blending coffees.

Although it has long been held that green coffee improves with age, and there is little doubt that this is true in so far as roasting merits are concerned, the question has been raised among coffee experts as to whether age improves the drinking qualities of the coffees of all countries equally.

Rio coffees should improve with age, as they are naturally strong and earthy. Age might be expected to soften and to mellow these and others having like characteristics. If, however, the coffee is mild in cup quality in the first instance, then it may be asked if age does not weaken it, so that in time it must become quite insipid. Several years ago, a New York coffee expert pointed out that this is what happens to Santos coffees. The new crop, he said, is always a more pleasant and enjoyable drink than the old crop, because it is a more pronounced mild coffee in the cup.

**MEXICANS.** All coffees grown in the republic of Mexico are known as Mexicans. They are further divided according to the states and districts in which they are produced, and as to whether they are prepared according to the wet or the dry method. The types best known in the American market are Coatepec, Huatusco, Pluma Oaxaca, Orizaba, Cordoba, Oaxaca, and Tapachulas. The lesser known are the Uruapan, Michoacan, Colima, Triunfo, Tabasco, Tampico, and Coatzacoalcos. Some of these are rarely seen in the markets of the United States.



MEXICAN BEANS—ROASTED

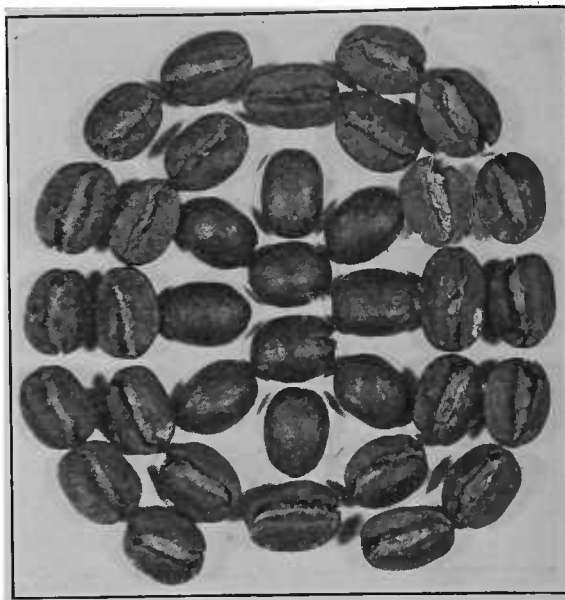
The coffee most cultivated in Mexico is supposed to have come from Mocha seed. Of this species is the Pluma Oaxaca, which is valued because of its sharp acidity and excellent flavor, two qualities that make it desirable for blending. The bean of the Sierra Oaxaca (common unwashed) is not large, nor is the appearance stylish.

Coatepec coffees are among the finest grown in Mexico, and rank with the world's best grades. They are quite acidic, but have a desirable flavor; and when blended with coffees like Bourbon Santos, make a satisfactory cup.

Orizabas, Cordobas, and Huatuscos are all grown in the State of Vera Cruz, but are less esteemed than the Coatepecs, being inferior in body, flavor, and smooth acidity. Many Huatuscos, however, compare very favorably with Coatepecs, both districts being close to the extinct volcano Orizaba. Fine Huatuscos and Coatepecs are frequently used interchangeably by roasters. Tapachula coffees are generally more like Guatemalan growths than any others produced in Mexico, which is natural in view of the proximity of the district to the northern boundary of Guatemala.

**CENTRAL AMERICANS.** Central American coffee is the general trade name applied to the growths produced in Guatemala, Honduras, Salvador, Nicaragua, Costa Rica, and Panama, the countries comprising Central America.

**GUATEMALA.** This country sends the largest quantity to the United States, and also produces the best average grades of the Central American districts. Guatemalas are mostly washed and are very stylish. The bean has a waxy, bluish color. Some of this coffee splits open when roasting and shows a white center. Low-grown Guatemalas are thin in the cup, but the coffees grown in the mountainous districts of Coban and Antigua are quite acidic and heavy in body. Some Cobans border on bitterness because of the extreme acidity. The bulk of the Cobans go to the London market. The Antiguas are medium, flinty beans; while Cobans are larger. Most of the Antiguas are shipped to San Francisco. Both grades are spicy and aromatic in the cup, and are particularly good blenders. Properly roasted to a light-cinnamon color, and blended with a high-grade combination, Cobans make serviceable coffees. Guatemalas are generally classified as noted in the Complete Reference Table.



GUATEMALA BEANS—ROASTED

**HONDURAS.** The upland coffee of Honduras is of good quality. The low-grown, as is common with all low-grown coffees, are the nondescript coffees but progress is being made in production and preparation methods, particularly in cleaning and handling. Honduras coffee consists mostly of small, round beans, bluish-green in color. The low-grown coffees are classified into first and second, with a large proportion of peaberry. The washed coffees are very slightly, good roasters, and drink exceedingly well. Until 1933 most of these coffees found European markets very receptive but because of economic and tariff conditions new markets in the North American countries were sought, with consequent decline in European shipments.

**SALVADOR.** Salvador coffee is equal to Guatemala's product, grade for grade. Only a small proportion is natural; the bulk of the crop is washed. The bean of both natural and washed is large and of very good roast. Washed coffees grown at low altitudes are of thin body, but the high-grown coffees are full bodied and excellent in quality. The largest part of the production goes to Europe. About twenty-five per cent of the exports are brought into the United States through San Francisco.

**NICARAGUA.** The ordinary run of Nicaragua coffee—the natural—is looked upon in the United States as being of low quality, though the washed coffees from the Matagalpa district have plenty of acid in

the cup and usually are fine roasters. Matagalpa beans are large and blue-tinged. Germany, Great Britain, and France take about all the Nicaragua coffee exported, only about six per cent of the total coming to the United States under normal conditions, although in 1934 thirteen per cent reached the United States because of the European exchange situation. These coffees are described more in detail in the Complete Reference Table.

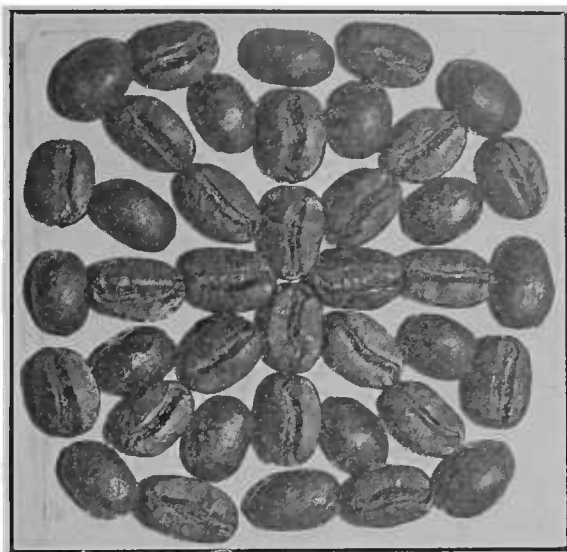
**COSTA RICA.** Good grades of Costa Rica coffee, such as are grown in the Cartago, San José, Alajuela, Grecia, and other districts at high altitudes, are highly esteemed by blenders. They are characterized by their fine flavor, rich body, and sharp acidity. Owing to careless methods of handling, sour or "hidey" beans are sometimes found in the chops of Costa Ricans from the lowlands, but the quantity is small as care is generally taken in their preparation.

**PANAMA.** Panama grows coffee principally for domestic use. A small proportion finds a European market in Norway, Sweden, and Denmark. The bean is of good size and tends toward green in color. In the cup it has heavy body and strong flavor. Characteristics are similar to the Costa Rican coffees. Coffee grown in the Boquette Valley is considered to be of fine quality, owing no doubt to the care given to its cultivation by American and English planters in that district.

#### *South America*

**COLOMBIA.** Colombia produces some of the world's finest coffees, of which the best known are Medellins, Armenias, Manizales, Bogotas, Girardots, Hondas, Bucaramangas, and Cúcutas. Old-crop Colombians of the higher grades, when mellowed with age, have many of the characteristics of the best East Indian coffees, and in style and cup are difficult to distinguish from the best of these growths. Such coffees are scarce on the American market, practically all the shipments coming to the United States being new crop and lacking some of the qualities of the mellowed beans. Compared with Santos coffee, good grade Colombians give one-fourth more liquor of a given strength with better flavor and aroma. They are classed and graded as noted in the Complete Reference Table.

Medellins are fancy mountain-grown coffees, and are esteemed for their good qualities. The beans vary in size, and the color



BOGOTA (COLOMBIA) BEANS—ROASTED

ranges from light to dark green, making a rather rough roast. In the cup they have a fine, rich, distinctive flavor, and in the American grading are regarded by many as the best of the Colombian commercial growths.

Manizales coffees, from point of production, are the most important of the Colombian growths. Recently the quality has been greatly improved. They are characterized in the cup by full body and flavor. They are generally lower-priced than Medellins, for which they make an acceptable substitute.

Armenias rank next to Medellins. They have good aroma and flavor, full body, with good acidity and clear cup.

Bogotas of good grade are noted for their acidity, body, and flavor. When the acidity is mellowed with age, this coffee has a better balance than most Colombians and can be used "straight," which can not be done with many other growths. In the green, Bogotas range from a blue-green bean to a fancy yellow. The bean is long, and generally has a sharp turn in one end of the center stripe. It is a smooth roaster, and has a rich mellow flavor.

Bucaramangas are regarded favorably in the American markets as good commercial coffees for blending purposes and, because of their heavy body, are much used to give "back-bone" to blends.

Tolimas are considered good grade average coffees, and are characterized by a fair-sized bean, attractive style, and good cup quality.



MARACAIBO BEANS—ROASTED

Cúcuta coffees, though grown in Colombia, are generally classified among the Maracaibos of Venezuela, because they are mostly shipped from that port. They are described with the Venezuelan coffees.

VENEZUELA. The coffees of Venezuela are generally grouped under the heads of Maracaibo, Caracas, and Puerto Cabello. Maracaibo and Puerto Cabello coffees take their names from the ports through which they are shipped. Caracas coffees are shipped through the port of La Guaira. Each group is further subdivided by the names of the districts in which the principal plantations lie. La Guaira coffee includes that produced in the vicinity of Caracas and Cumana.

Caracas coffee is best known in the European market. The washed Caracas is in steady demand in France and Spain. The bean is bluish in color, somewhat short, and varying in size. Some light-blue washed Caracas coffees are very desirable, and have a peculiar flavor that is quite pleasant to the educated palate. They are usually light and acid. Caracas chops rarely hold their style for any length of time, as the owners usually are not willing to dry properly and thoroughly before milling. When, however, the price is right, American buyers will use some Caracas chops instead of Bogotas. At equal prices the latter have the preference, as they have more body in the cup. Puerto Cabello coffees are valued just below Caracas. They are grown at a lower altitude, and are generally inferior in flavor.

Not less than one-third of Puerto Cabello coffees come across the thirty-mile gulf to the westward from the port of Tucacas, in a little steamer called the "Barquisimeto," which is famous all along the coast as the "cocktail shaker." C. H. Stewart<sup>1</sup> solemnly asserts that "Barky" can do the "shimmy" when lying at anchor in quiet waters.

Tachira and Merida coffees are considered the best of the Maracaibo grades, Tovars and Trujillos being classed as lower in trade value. Though Cúcuta coffee is grown in the Colombian district of that name, it is largely shipped through Maracaibo; and hence is classed among the Maracaibo types. It ranks with Tachiras and other fine Maracaibos. These coffees make good-appearing roasters, splitting open, and showing irregular white centers. New-crop beans are sometimes sharply acid, though they mellow with age and gain in body.

The state of Tachira lies next to the Colombian boundary, and its mountains produce fine coffees of varying size and style, possessing cup qualities which make them much sought after. They age well and, being of good body, the old crops—other things being equal—frequently bring a tidy premium.

The Rubio section of Tachira produces the best of its washed coffees. Here are several of the largest and best-equipped estates in Venezuela. The *trillados* of Tachira rank with the best in the country, owing to their large bean, solid color, and good quality. They roast well, and cup with good body. Good Tachira *trillados* are sold on the same basis as the Cúcutas, which they resemble.

The Meridas are raised at higher altitudes than Cúcutas, and good grades are sought for their peculiarly delicate flavor and high acidity. They rank with the best of the Maracaibo types. The bean is high-grown, of medium size, and roundish. It is well knit, and brings the highest price while it still holds its bluish style, as it then retains its acidity and character.

Tovars rank between Trujillos and Tachiras. They are fair-to-good body, flavory and usually roast free from quakers.

<sup>1</sup> Stewart, C. H., "The Coffee Status of Venezuela," *Tea and Coffee Trade Journal*, January, 1922. (pp. 29-35.)



Boconos, one of the better-known Venezuelan types, are light in color and body. Generally, the bean is round and small to medium in size. Their flavor is rather neutral, and they are frequently used as fillers in blends. Trujillos lack acidity and make a dull, rough roast, unless aged. They are blended with Bourbon Santos to make a low-priced palatable coffee. Some coffees of merit are produced at Santa Ana and Monte Carmelo.

#### *Other South American Countries*

The coffees from other South American countries, even where there is an appreciable production, are not important factors in international trade. The coffee of Ecuador, shipped through the port of Guayaquil, goes mostly to France, Spain, and Italy; a comparatively small quantity being exported to the United States. The bean is small to medium in size, being pale green in color and not desirable in the cup. The coffee is about equal to low grade Brazil and is used principally as filler. The chief sections of cultivation are the provinces of Manabi, Guayas, Los Rios, and El Oro, also some cultivations are found in the eastern region and the Galapagos Islands.

Peru produces an ever-lessening quantity of coffee, the bulk of the exports going to France, Germany, and Chile. It is a low altitude growth and is considered poor grade. The bean ranges from medium to bold in size, and from bluish to yellow in color.

Bolivia is an unimportant factor in the international coffee trade, most of its exports going to Chile. The chief variety produced is called the Yunga, which is considered to be of superior quality; but only a small quantity is grown. Guiana's coffee trade is insignificant. The three best-known types are the Surinam, Demerara, and Cayenne.

#### *The West Indies*

Coffee either is, or can be, grown practically everywhere in the West Indies; but the chief producing districts are found on the islands of Puerto Rico, Haiti and Santo Domingo, Jamaica, and Guadeloupe. Coffees coming from these islands are generally known by the name of the country of production, and may be further identi-

fied by the names of the districts in which they are grown.

**PUERTO RICO.** Since the United States took possession of Puerto Rico, soil experts have endeavored to raise the quality of the coffee grown there, especially the lower grades, which had peculiarly wild characteristics. Today, the superior grades of Puerto Rican coffees rank among the best growths known to the trade. The bean is large, uniform, and stylish; ranging in color from a light gray-blue to a dark green-blue. The coffee roasts well, and has a heavy body, similar to the fanciest Mexicans and Colombians. Its cup is not as rich, but it makes a good blend. Puerto Rican coffees command a higher price in France than in the United States, which accounts for the larger proportion of exports to Europe, excepting when the French market was cut off during the World War. Yauca is the best of the Puerto Rican grades, followed by "Picked Haciendas" and "Haciendas."

**JAMAICA.** Jamaica produces two distinct types of coffee, the highland and the lowland growths. Among the first-named is the celebrated Blue Mountain coffee, which has a well-developed pale blue-green bean that makes a good-appearing roast and a pleasantly aromatic cup. It is frequently compared with the fancy Cobans of Guatemala. After Blue Mountain the gradings may be listed as follows, in the order of their merit: Manchester, Black River, Good ordinary (best of the low grows), and Ordinary. The lowland coffee is a poorer grade, and consists largely of a mixture of different growths produced on the plains. It has a fair-sized bean, green to yellow in the "natural," and blue-green when washed. In the cup it has a grassy flavor, but is flat when drunk with cream. It is used chiefly as a filler in blends, and for French roasts. Most of the Jamaica production is sold in London and Canada, little of it being imported by the United States.

**HAITI AND SANTO DOMINGO.** The coffees of these two republics have like characteristics, being grown on the same island and under about the same climatic and soil conditions. Careless cultivation and preparation methods are responsible for the generally poor quality of these coffees. Lately, however, the Government is giving aid to planters, and grading is being improved. When properly grown and cured, these

coffees rank well with good washed varieties, and have a rich, fairly acid flavor in the cup. The bean is blue-green, and makes a handsome roast. Sales are largely to France.

**GUADELOUPE.** Guadeloupe coffee is distinguishable by its green, long, and slightly thick bean, covered by a pellicle of whitish silvery color, which separates from the bean in the roast. It has excellent cup qualities. Sales are made mostly in France.

**OTHER WEST INDIAN ISLANDS.** Among the other West Indian islands producing small quantities of coffee are Cuba, Trinidad, Dominica, and Barbados. The growths are generally good quality, bearing a close resemblance to one another. Cuba is producing coffee in increasing quantities and occasionally exports some of the surplus.

#### *Asia*

**YEMEN (ARABIA).** For many generations Mocha coffee was recognized throughout the world as the best coffee obtainable; and until the Pure Food Law went into effect in the United States, other high-grade coffees were frequently sold by American firms under the name of Mocha. Now, only coffees grown in Arabia are entitled to that valuable trade name. They grow in a small area in the mountainous regions of the southwestern portion of the Arabian peninsula, principally in the province of Yemen, and are known locally by the names of the districts in which they are produced. Commercially they are graded as: Mocha Extra, for all extra qualities; Mocha No. 1, consisting of only perfect berries; No. 2, showing a few broken beans and quakers; No. 3, having a heavier percentage of broken beans and quakers and also some dust. Arabia being a geographical rather than a political division, shipments of her coffees (according to U. S. A. Customs Regulations, 1931, amended 1934, effective July 8, 1934) require shipments to be marked with the particular place of origin: Aden, Bahrein Islands, Hadramaut, Kumait, Oman, Qatar, Baudi Arabia, Trucial Coast, or Yemen.

Mocha beans are small, hard, roundish, and irregular in form and size. In color, they shade from olive green to pale yellow, the bulk being olive green. The roast is poor and uneven, but the coffee's virtues are shown in the cup. It has a dis-

tinctive pungent winy flavor, and is sharp with acidity—two qualities which make a straight Mocha brew especially valuable as an after-dinner coffee, and also esteemed for blending with fancy, mild, washed types.

As in other countries, the coffees grown on the highlands in Yemen are better than the lowland growths. As a rule, the low-altitude bean is larger and more oblong than that grown in the highlands, due to its quicker development in the regions where the rainfall, though not great, is more abundant.

While Mocha coffees are known commercially by grade numbers, the planters and Arabian traders also designate them by the name of the district or province in which each is grown. Among the better grades thus labeled are: Yaffey, Anezi, Mattari, Sanani, Sharki, and Haimi-Harazi. For the poorer grades, these names are used: Remi, Bourai, Shami, Yemeni, and Maldi. Of these varieties, Mattari, a hard and regular bean, pale-amber in color, commands the highest price, with Yaffey a close second. Harazi coffee heads the market for quantity coupled with general average of quality.

**INDIA AND CEYLON.** Coffees from India are marketed almost exclusively in London and France, little reaching the American trade. The best East India coffee comes from the Nilgiri Hills. Nilgiri coffee is famous for its fine blue color, cleanliness of bean, and liquoring properties, and commands a premium accordingly. It is closely followed in quality by Shevaroy coffee. The next on the list are the Anamalai and Kanan Devan Hills—the former being of the greater importance of the two. Then come Coorg and Mysore coffees, the average qualities of which are about the same. Mysore, however, is the most important factor in the East Indian supply, and contains favored zones which produce a quality of coffee almost equal to Nilgiri; *e.g.*, the Bababudan District. Mysore coffee also ranks high on the English market. It is mountain grown, and the bean is large and blue-green in color. Telli-cherry is another good-grade coffee, closely resembling Malabar, grown on the slopes of the Western Ghats. Coorg (Kurg) coffee is an inferior growth. It is a lowland type, and in the cup is thin and flat. The bean is large and flat, and tends toward dark green in color. Travancore is another

lowland growth, ranking about with Coorg, and has the same general characteristics.

Nelliampathy and Pulney (or Dindigul) coffees are about equal to the average quality Mysore, but Pulney is almost entirely consumed in India.

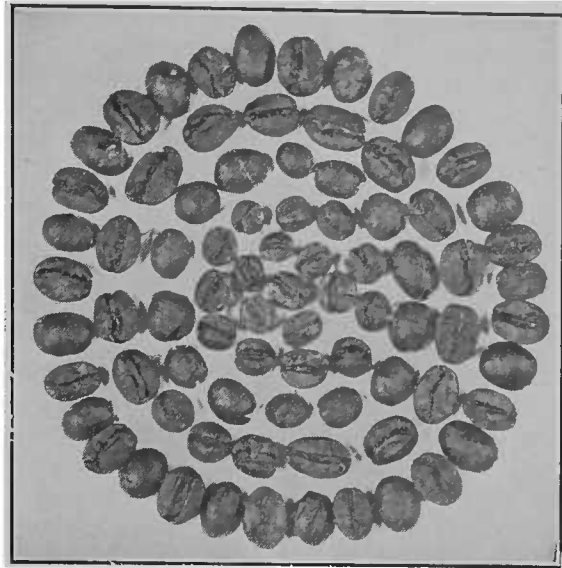
A small amount of coffee from the Billigirirangan Hills sometimes commands a premium equal to that of Nilgiri coffee. Coffee in the Wynaad Hills has practically died out, and has been replaced by tea.

Ceylon, although once one of the world's most important producers, lost practically its entire coffee industry by attacks of *Hemileia*. Owing to the ravages of the leaf pest, which began in 1869 and continued several years, the plantations were largely turned over to tea and rubber production.

**FRENCH INDO-CHINA.** The coffee of French Indo-China is highly prized in France, where the bulk of the export goes. The coffee tree grows well in the provinces of Tonkin, Annam, Cambodia, and Cochin-China. Tonkin is the largest producer, and grows the best varieties. In the cup, Tonkin coffee is thought by French traders to compare favorably with Mocha. Of the several varieties of *Coffea arabica* grown in Indo-China, the *Grand Bourbon*, *Bourbon rond*, and the *Bourbon le roy*, are the best known. The first-named is a large bean of good quality; the second is a small, round bean of superior grade; and the third is a still smaller bean of fair cup quality.

#### Africa

**ETHIOPIA (ABYSSINIA).** The coffee grown in Ethiopia is classified commercially into two varieties: Harar, which is grown principally in the district around Harar; and Ethiopian, produced mainly in the provinces of Djimmah, Sidamo, and Guma. Harar coffee is the fruit of cultivated trees, while Ethiopian comes from wild trees. The first-named produces a long and well-shaped berry, and is often referred to as Longberry Harar. The bean is larger than Mocha, but similar in general appearance. Its color shades from blue-green to yellow. Good grades of Harar have cup characteristics resembling Mocha, but have more acid, and by some are preferred to Mocha, because of their winier cup flavor. The Ethiopian coffee is considered much inferior to Harar, and chops generally contain many imperfections. The bean is dark



MOCHA BEANS—ROASTED

brown in color. Large quantities of Ethiopian coffee now come to the United States. Harar coffee is separated into three grades: (1) Extra sifted, all large beans; (2) Shortberry Harar, all small beans; and (3) Longberry Harar, between the preceding two grades.

U. S. A. Customs Regulations require that Ethiopian (Abyssinian) and Harar coffee shipments be marked Ethiopia.

**BRITISH EAST AFRICA.** Of late years, coffee from British East Africa has become of noticeable importance. This is the product of Kenya, Tanganyika, Uganda, North Rhodesia, and Nyasaland. *Arabica* and *robusta* are the principal varieties grown. Kenya produces the *arabica* variety, the coffee having acid cup characteristics. In England Kenyas are often blended with the better-quality coffees of Central America. Uganda and Tanganyika produce *arabica* and *robusta*. Uganda *arabicas* are sweeter in the cup than Kenyas. Tanganyika *arabicas* are grown on Mount Kilimanjaro and are of excellent quality. The robustas are used for fillers. The coffees produced in North Rhodesia and Nyasaland are similar to Kenyas.

**FRENCH COLONIES.** The coffee producing French Colonies comprise MADAGASCAR, NEW CALEDONIA and NEW HEBRIDES (two island colonies in the South Pacific), FRENCH WEST AFRICA, FRENCH EQUATORIAL AFRICA, CAMEROONS, INDO-CHINA and GUADELOUPE. Madagascar produces increasing quantities for export, most of it being

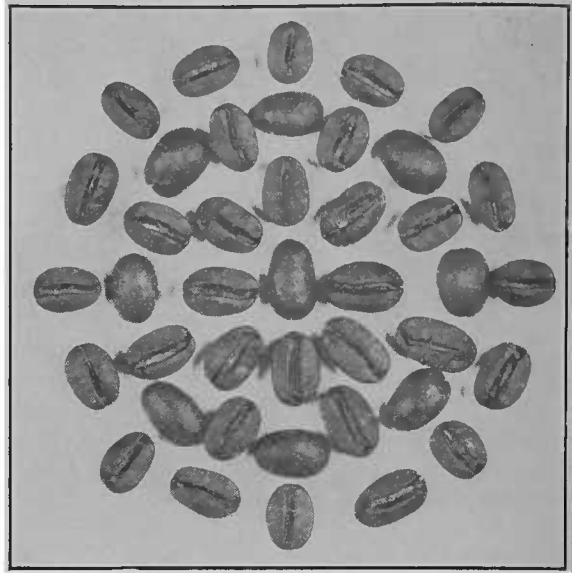
Robusta of the *canephora* species and a small quantity of Liberia of indifferent quality. The coffee is considered fair average, with rich flavor, and considerable fragrance. France is the largest market. Little comes to the United States. New CALEDONIA coffee is of the *arabica* variety, the quality fair and output small. This description also applies to the output of NEW HEBRIDES. The Ivory Coast of FRENCH WEST AFRICA produces mostly *liberica* coffee (*excelsa* species) with some of the *arabica* variety coming into production. The Liberian type and some Robustas of good quality are grown in the Cameroons district of FRENCH EQUATORIAL AFRICA while both Liberian and Robusta coffees and some of the *arabica* variety are grown in the FRENCH CONGO.

Many other African countries produce coffee. Liberian coffee, grown on the west coast, in Liberia, Sierra Leone, and Nigeria, is used to mix with Bourbon Santos to some extent; but it is generally considered low grade, although it makes a handsome, elephantine roast. The product of French Cameroons is a very small bean, half-way between a peaberry and a flat bean, and has a dingy brown color. It is considered worthless as a drink. A medium-sized, strong-flavored *arabica* bean that is rich in the cup, is grown in the highlands of Belgian Congo, while *robusta* is found in the lowlands. In Angola a fair quantity of coffee is produced. In the cup it has a strong and pungent flavor, but lacks smoothness and aroma. Bourbon coffee, grown on the island of Réunion, commands a high price in the French market, where practically all exports go. It is a small, flinty bean, giving a rich and fragrant cup.

#### *East Indian Islands*

Some of the coffees from the East Indian islands rank among the best in the world, particularly those from Sumatra. East India coffees are distinguished by their smooth, heavy body in the cup, the fancy grades giving an almost syrupy richness.

JAVA. Java coffees are generally of a smaller bean than those from Sumatra and are not as favorably considered by most buyers. The new crop growths have a grassy flavor which many find unpleasant when drinking straight. Under the old system, coffee was bought by the Government and held in godowns from 18 months



WASHED JAVA BEANS—ROASTED

to two years until they became brown and mellow with age. In late years, this system has been entirely abandoned, and the planters sell their product as they please, and in most cases without ageing.

Before the advent of large fleets of steamers in the East Indian trade, the coffee was brought to America in sailing vessels that required from three to four months for the trip. During the voyage the coffee went through a sweating process which turned the beans from green to a dark brown, provided the captain of the vessel kept his hatches battened down. It was to his advantage to suffer this inconvenience, because all consignees were willing to give him a gratuity upon arrival at destination if the coffees turned out brown, as this considerably enhanced their value. The sweating was due to the coffee being loaded while moist and then practically sealed in the vessel's hold during all its trip through the tropical seas. As a consequence, the cargo steamed and foamed, and, as a rule, part of the coffee became moldy, but the damage seldom extended more than one or two inches into the mats, and then only on the top layers. Naturally sweated coffees command a premium from 3c. to 5c. more than those that come green and pale.

Before the leaf disease struck Java, *Coffea arabica* was grown abundantly throughout the island. Each residency had numerous estates, and their names were given to the coffees produced. The best native coffees came from Preanger, Cheribon, Buit-

enzorg, and Batavia, ranking in merit in the order named.

**SUMATRA.** Sumatra has the reputation of producing two of the finest and highest-priced coffees in the world; namely, Mandheling and Ankola. Mandheling coffee is a large, full bean which roasts slightly dull but is generally free from quakers. It is heavy in body and has a unique flavor that easily distinguishes it from any other growth.

The Ankola bean is shorter and better appearing than Mandheling, but otherwise bears a close resemblance. Its flavor is similar to Mandheling, and like that coffee is used for blending with the best grades of Mocha and other fine acid growths, where body is needed to round out the blend.

Mandhelings and Ankolas are the best known to the American trade. They are shipped through the ports of Padang and Sibolga on the West Coast and Medan on the East Coast. Many buyers order these coffees to be aged in the godown for a per-

iod of four to six months. The coffees are arranged on wooden floors in piles one or two feet high and turned each day, thereby attaining a uniform brown color and resulting in a rich mellow drink when brewed.

Sumatra also produces Palembang coffee of the *robusta* variety in limited quantity, which has a sale in Europe, but is not favored in the United States.

**ROBUSTAS (East Indian).** Cultivation of the *robusta* variety in the East Indies started when the coffee pest destroyed the majority of the old plantations, and the planters turned to raising rubber and wanted a shade tree for the young rubber shoots. As its name indicates it is a very hearty and robust coffee. The trees were not cultivated until after the collapse of the rubber boom, when the planters turned their attention to the careful cultivation of the coffee tree; with the result that Robusta production has become an important factor, these coffees being used in many instances in place of Brazils.



TESTING COFFEE IN THE ESTABLISHMENT OF A NEW YORK GREEN COFFEE IMPORTER



Palembang is the largest harbor in Sumatra for the shipment of Robustas. Other Sumatra ports from which Robusta coffees are shipped in quantity are Telok-Betong, Benkoelen, Padang, Sibolga, and Medan.

Robusta coffees are principally used as a "price" proposition in the United States or as a filler to reduce the cost of other growths of coffee. They are rather neutral in the cup and therefore useful in blending.

Other East India coffees are Timors, Boengies, and Menados, which find a market in Europe but not in the United States.

#### *The Pacific Islands*

The Philippine Islands have not figured in international coffee trade since 1892, although in preceding years the Philippines exported several million pounds of an average good grade of coffee. The bean is medium size, grayish-green in color, having fine aroma and excellent flavor. It compares favorably with Costa Rica and Guatemala growths.

HAWAII. A large percentage of Hawaiian coffee is grown in the Kona district. This coffee has a large bean, the new crop being blue-green in color but yellow-brown when aged. The old crops are rich and mellow in the cup. Fancy Kona coffee brings a high price, often selling on a par with fancy Costa Ricas. Konas blend well with any high grade mild coffee. They are especially popular on the Pacific Coast of the United States.

#### *Appearance, Aroma, and Flavor in Cup-Testing*

Before the beginning of the twentieth century, practically all the coffees bought and sold in the United States were judged for merit simply by the appearance of the green or the roasted bean. Since that time, the importance of testing the drinking qualities has become generally recognized; and today every progressive coffee buyer has his sample-roasting and testing outfit with which to make painstaking cup tests. Both buyers and sellers use the cup test, the former to determine the merits of the coffee he is buying, and the latter to ascertain the proper value of the chop under consideration. Frequently, a test is made to fix the relative desirability of various

growths considered as a whole, using composite samples that are supposed to give representation to an entire crop.

The first step in testing coffee is to compare the appearance of the green bean of a chop with a sample of known standard value for that particular kind of coffee. The next step is to compare the appearance when roasted. Then comes the appearance and aroma test, when it is ground; and finally, the most difficult of all, the trial of the flavor and aroma of the liquid.

Naturally the tester gives much care to proper roasting of the samples to be examined. He recognizes several different kinds of roasts which he terms the light, the medium, the dark, the Italian, and the French roasts, all of which vary in the shadings of color, and each of which gives a different taste in the cup. The careful tester watches the roast closely to see whether the beans acquire a dull or bright finish, and to note also if there are many quakers, or off-color beans. When the proper roasting point is reached, he smells the beans while still hot to determine their aroma. In some growths and grades, he will frequently smell of them as they cool off, because the character changes as the heat leaves them, as in the case of many Maracaibo grades.

After roasting, the actual cup-testing begins. Two methods are employed, the blind cup test, in which there is no clue to the identity of the kind of coffee in the cup; and the open test, in which the tester knows beforehand the particular coffee he is to examine. The former is the most generally employed by buyers and sellers, although a large number of experts who do not let their knowledge interfere with their judgment, use the open method.

In both systems the amount of ground coffee placed in the cup is carefully weighed, so that the strength will be standard. Generally, the cups are marked on the bottom for identification after the examination. Before pouring on the hot water to make the brew, the aroma of the freshly ground coffee is carefully noted to see if it is up to standard. In pouring the water, care is exercised to keep the temperature constant in the cups, so that the strength in all will be equal. When the water is poured directly on the grounds, a crust or scum is formed. Before this crust breaks, the tester sniffs the aroma given off; this is called the wet-smell, or

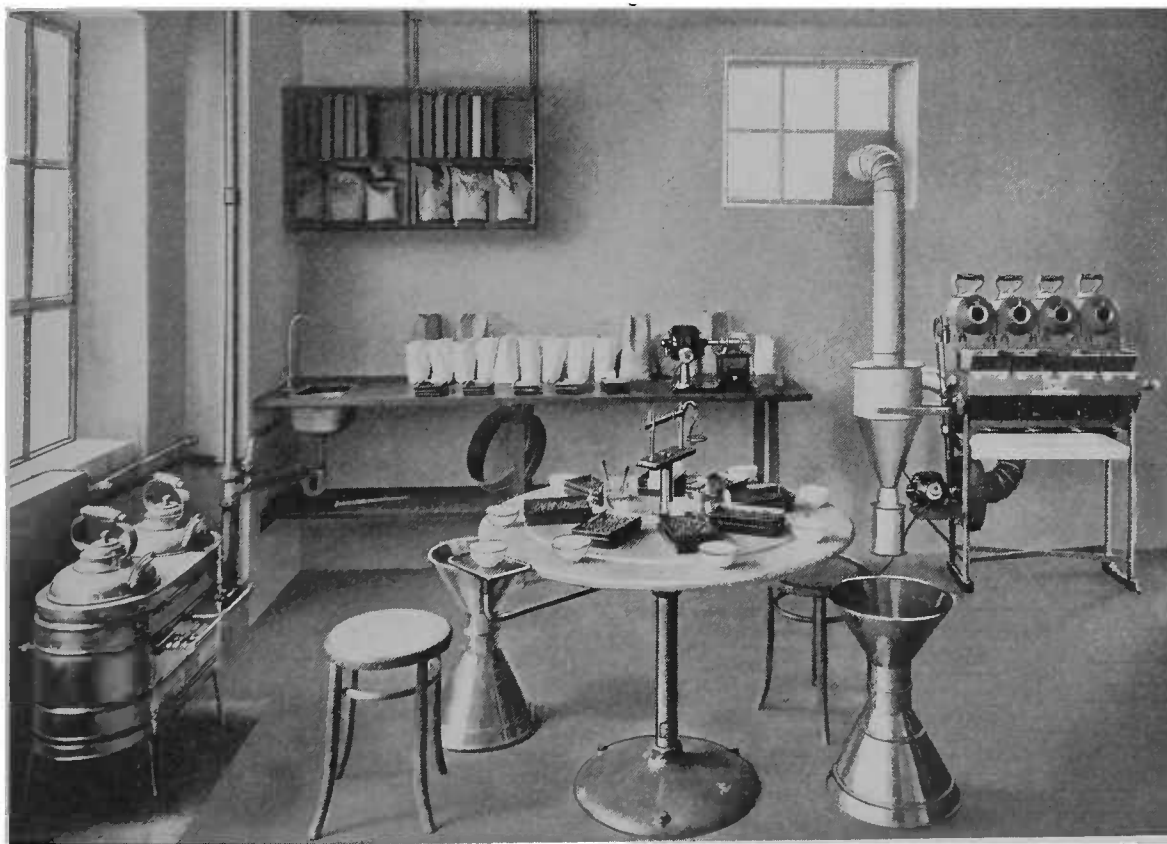
crust, test, and is considered of great importance.

Of course, the taste of the brew is the most important test. Equal amounts of coffee are sipped from each cup, the tester holding each sip in his mouth only long enough to get the full strength of the flavor. He spits out the coffee into a brass cuspidor which is designed for the purpose. The expert never swallows the liquor.

Cup-testing calls for keenly developed senses of sight, smell, and taste, and the faculty for remembering delicate shadings in each sense. By sight, the coffee man judges the size, shape, and color of the green and roasted bean, which are important factors in determining commercial values. He can tell also whether the coffee is of the washed or unwashed variety, and whether it contains many imperfections such as quakers, pods, stones, brokens, off-colored beans, and the like. By his sense of smell of the roast and of

the brew, he gauges the strength of the aroma, which also enters into the valuation calculation. His palate tells him many things about a coffee brew: if the drink has body and is smooth, rich, acidy or mellow; if it is winy, neutral, harsh, or Rio-y; if it is musty, groundy, woody, or grassy; or if it is rank, hidey, sour, muddy, or bitter.

The up-to-date cup-tester requires special equipment to get the best results. A typical installation consists of a gas sample-roasting outfit, employing at least a single cylinder holding about six ounces of coffee, and perhaps a battery of a dozen or more; an electric grinding mill; a testing table, with a top that can be revolved by hand; a pair of accurately adjusted balance scales; one or more brass kettles; a gas stove for heating water; sample pans; many china or glass cups; silver spoons; and a brass cuspidor that stands waist high and is shaped like an hour glass.



TYPICAL COFFEE SAMPLE-ROASTING AND CUP-TESTING OUTFIT

In the middle of the picture is a standard revolving table (3½ feet in diameter), with scale mounted over the center, and with a tray at the table edge for holding and moving one cup— independent of the table movement. There are two cuspidors, a double kettle outfit, a 4-cylinder sample roaster and a motor-driven sample grinder; also a set of sample separator sieves in the overhead rack, a bag sampler (lying on the lower shelf of the counter), and some coffee crushers (one on the end of the counter and one on the revolving table).

**COMPLETE REFERENCE TABLE**  
**OF**  
**THE PRINCIPAL KINDS OF COFFEE GROWN IN THE WORLD**  
*With Their Trade Values and Cup Characteristics*

The trade values and cup characteristics given in this table refer to new crop coffees, unless otherwise specified.

*t*, indicates town or trading center; *m n*, market name; *d*, district or state.

<i>Grand Division</i>	<i>Country</i>	<i>Shipping Ports</i>	<i>State, or District, Market Names and Gradings</i>	<i>Trade Values and Cup Characteristics</i>
North America	Mexico		Mexicans, <i>m n</i>	<i>In general:</i> Mexicans are mild or mellow. The green beans are greenish to yellow (when aged) and of good size. The washed coffees make a handsome roast, some showing pronounced white central stripe. In the cup they have a full rich body, fine acidity, and a wonderful <i>bouquet</i> .
		Vera Cruz on Gulf of Mex.	Vera Cruz, <i>d</i> Jalapa, <i>t</i> (pro., ha-lap-a) Coatepec, <i>m n</i> (pro., co-at-e-pec)	The high-grown are of excellent, heavy, and rich flavor; fine for blending. The low-grown have less acid and body.
			Huatusco, <i>m n</i> (pro., wha-toos-co)	Fine appearing washed coffee; next to Coatepec for acid and blending qualities, often used interchangeably with Coatepecs.
			Orizaba, <i>m n</i>	Regarded as next to Huatusco; good cup quality.
			Cordoba, <i>t &amp; m n</i>	Neutral, smooth in flavor, light acidity; good body.
		Alvaro Obregon	Tabasco, <i>d &amp; m n</i>	Of uncertain character; many of them Rio-y, flat, and groundy. Unsatisfactory in the cup. Some have a very fine, distinctive flavor.
		Puerto Mexico Vera Cruz Ventosa	Chiapas, <i>d</i> Tapachula, <i>t, m n</i>	Resemble Guatemala coffees; smooth in character, and without decided tang, except for hard-bean coffees.
		Vera Cruz	Oaxaca, <i>d, m n &amp; t</i> (pro., wah-hock-ah) Sierra Oaxaca, <i>m n</i> (common-unwashed)	Small bean; excellent quality, sharply acid, fine flavor, but not stylish in appearance. The Pluma is a very fancy bean coffee, also acid and
		Puerto Angel	Pluma Oaxaca, <i>m n</i>	

COMPLETE REFERENCE TABLE

<i>Grand Division</i>	<i>Country</i>	<i>Shipping Ports</i>	<i>State, or District, Market Names and Gradings</i>	<i>Trade Values and Cup Characteristics</i>
North America ( <i>Cont'd</i> )	Mexico ( <i>Cont'd</i> )	Puerto Escondido	Pochutla, <i>t</i>	fine for blending. Lacks body.
		Acapulco on Pacific	Guerrero, <i>d</i> Sierra, <i>m n</i>	Inferior in quality; low growth and woody.
		Manzanillo on Pacific	Michoacan, <i>d</i> Uruapan, <i>t &amp; m n</i>	A superior coffee, but not produced in commercial quantity.
		Do.	Colima, <i>d, m n &amp; t</i>	Very like Uruapan.
		Vera Cruz	Puebla, <i>d</i> Mexico City, <i>t</i> Sierra, <i>m n</i>	Low-grade mountain coffee.
		Tampico	Tamaulipas, <i>d</i> Mexico City, <i>t</i> Tampico, <i>m n</i>	An inferior grade.
		Tepic	So called "Mexican Mocha." Raised for local consumption. Not a commercial factor.	
<i>Classes for All Mexicans</i> 1. Natural. 2. Washed. 3. Caracol.				
Central America	Guatemala	Puerto Barrios and Livingston on Caribbean San José Champerico on Pacific	Guatmalas, <i>m n</i>	<i>In general:</i> Guatemalas are mild or mellow and mostly washed. The green beans are greenish to yellow (when aged), and of large size. The mountain-grown coffees make a handsome roast, are of full heavy body and excellent cup quality. The lower-altitude coffees are light in cup, but flavory.
			Cobán, <i>d &amp; m n</i>	Waxy, bluish bean; handsome uniform roast with white center. Heavy body, fine acidity.
			Alta Verapaz, <i>d</i> Sehenaju, <i>t</i> Antigua, <i>d</i> Costa Cuca, <i>d</i> Costa Grande, <i>d</i> Barberena, <i>d</i> Tumbador, <i>d</i> Costa de Cucho, <i>d</i> Chicacao Xolhuitz, <i>d</i> Pochuta Malacatan, <i>d</i>	Gray-blue bean; fine mellow flavor. See Belize. Vary from good hard bean to medium flinty bean. Some are lighter in body; flavory, acid.
			San Marcos, <i>d</i> Chuva, <i>d</i> Escuintla, <i>d</i> San Vincente, <i>d</i> Pacaya, <i>d</i> Moran, <i>d</i> Amatitlan, <i>d</i> Palmar, <i>d</i>	<i>Classes for All Guatemalas</i> Most Guatemalas are washed and may be classified as follows: 1. Small flinty bean, extremely acid and flavory, produced in the highest altitudes of the Antigua, Moran, and Amatitlan districts.

## ALL ABOUT COFFEE

<i>Grand Division</i>	<i>Country</i>	<i>Shipping Ports</i>	<i>State, or District, Market Names and Gradings</i>	<i>Trade Values and Cup Characteristics</i>
Central America (Cont'd)	Guatemala (Cont'd)		<p>Motagua, <i>d</i> Chicacao, <i>d</i> Panan, <i>d</i> Turgo, <i>d</i> Sumatan, <i>d</i> Zunil, <i>d</i> Colomba, <i>d</i></p> <p>3. Waxy, bluish bean, handsome uniform roast, heavy-bodied but non-acid coffees produced in almost every district of the republic at an altitude of from 2,000 to 3,000 feet.</p> <p>4. Stylish, green bean, handsome large uniform roast, very white center, mild cupping coffees produced practically everywhere in the republic at an altitude of from 1,500 to 2,500 feet.</p> <p>5. The lower altitudes of the various districts produce either medium bean, neutral cupping, colory coffees, or the Bourbon type of small bean, greenish coffee.</p> <p>6. Maragogipe, the giant-bean variety, is produced on a moderate scale in practically all sections of Guatemala. It is neutral in the cup.</p>	<p>2. Waxy, bluish bean, flinty, but large roast; heavy body with fine acidity. Produced in the mountainous regions of the Cobán, Costa Cuca, Tumbador, and Chuva districts.</p>
	British Honduras	Belize	Belize, <i>m n</i>	A Cobán coffee from the Alta Verapaz district in Guatemala.
	Honduras	Trujillo and Puerto Cortés on Caribbean  Amapala on Pacific	Honduras Santa Barbara, <i>d</i> Copan, <i>d</i> Cortez, <i>d</i> La Paz, <i>d</i> Choluteca, <i>d</i> El Paraiso, <i>d</i>	<i>In general:</i> Nearly all Honduras coffee consists of small, round berries, bluish green in color. The low-grown are classified into first and second with a large proportion of peaberry. The washed coffees are very slightly, roast well, and drink exceedingly well.
	El Salvador	Acajutla La Union La Libertad	Salvador Usulután, <i>d</i> La Libertad, <i>d</i> Santa Ana, <i>d</i> Santa Tecla, <i>d</i> La Paz, <i>d</i> Ahuachapan, <i>d</i> Juayua, <i>d</i> Santiago de Maria, <i>d</i> Sonsonate, <i>d</i> San Miguel, <i>d</i> San Salvador, <i>d</i> San Vicente, <i>d</i> Cuscatlan, <i>d</i> Morazan, <i>d</i> Cabanás, <i>d</i> Chalatenango, <i>d</i> La Union, <i>d</i>	<p><i>In general:</i> Salvador's coffees are equal in quality to those of Guatemala, grade for grade. The bulk of the crop is washed. Green beans are smooth and handsome and make a cinnamon roast. Flavor is neutral. Useful mainly as a filler. The washed coffee is a fancy roaster, thin in cup when grown at low altitudes, but of full body and excellent quality when grown at high altitudes.</p> <p><i>Classes and Gradings for All Salvadors: Washed</i></p> <p>1. Flinty, colory, greenish to bluish bean, fine white centered roasters, extremely stylish coffees with full-bodied cup merit.</p>



COMPLETE REFERENCE TABLE

Grand Division	Country	Shipping Ports	State, or District, Market Names and Gradings	Trade Values and Cup Characteristics
Central America (Cont'd)	El Salvador (Cont'd)		2. Grayish green to bluish green neutral-cupping coffees.	
			<i>Unwashed</i>	
			1. Screened, large bean, fine roaster.	
			2. Average run, unscreened, so-called Current Unwashed. All unwashed coffees vary greatly in cup merit, much the same as with Santos coffees.	
	Nicaragua	Corinto on Pacific	Nicaragua	<i>In general:</i> The washed coffees of Nicaragua have merit, and are fine roasters; but the naturals, comprising the bulk of the crop, are of ordinary quality; often Rio-y.
		San Juan del Norte (Greytown) on Caribbean	Matagalpa, <i>d</i>	Large, handsome, washed bean, making fancy roast with plenty of acid in the cup.
			Jinotega, <i>d</i> Los Pueblos, <i>d</i> Los Altos, <i>d</i> Managua, <i>d</i> Carazo, <i>d</i>	
			<i>Classes for All Nicaraguas:</i>	
			1. Large, handsome, pale greenish to blue, washed coffee of the Matagalpa district, often showing fancy roast and acidly full-bodied cup.	
			2. Washed coffees of the lower regions; small in size, but greenish, colory, fine roasters and neutral cupping.	
			3. Unwashed coffee (bulk of the output) the merit of which depends entirely on the respective crop. Often a large proportion of the crop is mild cupping and as desirable as any other unwashed coffee; while another crop may produce a large quantity of Rio-flavored coffees.	
	Costa Rica	Puerto Limon on Caribbean Puntarenas on Pacific	Costa Rica Cartago, <i>d</i> San José, <i>d</i> Alajuela, <i>d</i> Grecia, <i>d</i> Tres Rios, <i>d</i> Heredia, <i>d</i> Juan Vinas, <i>d</i>	<i>In general:</i> The high-altitude coffees of Costa Rica are blue-greenish, large, rich in body, of fine, mild flavor, sharply acid, and superior for blending purposes. These coffees are famous for their preparation and careful grading. The lower regions produce coffees of more neutral-cupping qualities.
	Panama	Panama City	Panama Chiriqui, <i>d</i> Boquete, <i>m n</i> Volcan, <i>d</i>	<i>In general:</i> The green bean is of good size, greenish in color. In the cup it has a heavy body and a strong flavor. Has characteristics similar to Costa Rican coffees Grown chiefly for domestic consumption.

## ALL ABOUT COFFEE

<i>Grand Division</i>	<i>Country</i>	<i>Shipping Ports</i>	<i>State, or District, Market Names and Gradings</i>	<i>Trade Values and Cup Characteristics</i>
West Indies (Greater Antilles)	Cuba	Havana Santiago	Cuba Oriente, <i>d</i> Guatanamo, <i>t</i> Santa Clara, <i>d</i> Pinar del Rio, <i>d</i> Vuelta Abaja, <i>m n</i>	<i>In general:</i> Cuban coffee is of good quality. The bean is of medium size, light green, and makes a uniform roast. The flavor resembles the fine washed coffees of Santo Domingo. Not commercially important.
	Haiti	Port au Prince Cap Haitien	Haiti St. Marc, <i>d</i> Gonaive, <i>d</i> Cap Haitien, <i>d</i> Jacmel, <i>d</i> Les Cayes, <i>d</i> Jeremie, <i>d</i>	<i>In general:</i> The Haitian washed coffee is a blue bean and makes an attractive roast. It has a rich, fairly acid, mildly-sweet flavor; of average quality. The naturals are used extensively for French roasts.
	Santo Domingo	Santo Domingo Porto Plata	Santo Domingo Cape, <i>m n</i> Mocha, <i>d</i> Santiago, <i>d</i> Porto Plata, <i>d</i> Bani, <i>d</i> Barahona, <i>d</i>	<i>In general:</i> Santo Domingo coffee is a large, flat, pointed, greenish-yellow bean. The high-grown washed is of good body and fair flavor. The low grade is strong, approaching Rio in flavor. The natural coffees are used extensively for French roasts.
	Jamaica (British)	Kingston	Jamaica Classes: Blue Mountain (high-grown) Settlers' (ordinary, or plain-grown)	<i>In general:</i> Jamaica coffee is bluish-green when washed, and green to yellow when patio-dried. The washed high-grown makes a fancy roast, and is rich, full and mellow in the cup. The ordinary plain-grown makes a fair roast, and has a moderately good cup quality. The naturals are used extensively for French roasts.
Puerto Rico (U. S.)	Ponce San Juan Mayaguez Arecibo Aguadilla	Puerto Rico Sierra Luquillo, <i>m n</i> Yauca, <i>d, t &amp; m n</i> Ciales, <i>d &amp; t</i> Cayey, <i>d &amp; t</i> Utuaado, <i>d &amp; t</i> Lares, <i>d &amp; t</i> Moca, <i>d &amp; t</i> Adjuntas, <i>d &amp; t</i> Las Larias, <i>d &amp; t</i> Maricao, <i>d &amp; t</i> San Sebastian, <i>d &amp; t</i> Mayaguez, <i>d &amp; t</i> Ponce, <i>d &amp; t</i>	<i>In general:</i> Puerto Rico coffee is a large, handsome, washed bean, light gray-blue to dark greenish blue in color, and makes a fancy roast without quakers. Strong or heavy body; peculiar flavor similar to a washed Caracas, but smoother.  <i>Classes for All Puerto Ricos</i>  The three best grades in order of merit are Yauca, Picked Hacienda, and Hacienda. Then comes	

COMPLETE REFERENCE TABLE

Grand Division	Country	Shipping Ports	State, or District, Market Names and Gradings	Trade Values and Cup Characteristics
West Indies (Greater Antilles) (Cont'd)			Caracolillo, a round	bean peaberry; Primero, a superior grade of good size and color, usually hand-picked; Segundo, second grade, inferior to Primero in size and color; and Trillo, lowest grade, sold locally.
(Lesser Antilles)	British West Indies Antigua Dominica Barbados Trinidad Tobago	Saint John Portsmouth Bridgetown Port of Spain Scarborough	Antigua Dominica (Soufrière) Barbados Trinidad Tobago	<i>In general:</i> While the quantity grown is small, the coffee is of good quality, and includes ten different varieties. That grown in Barbados is similar to that of Martinique, but a larger bean. This group is not an important commercial factor.
	Guadeloupe (French)	Pointe-à-Pitre	Guadeloupe Classes: 1.—Bonifieur, or Café Lustre (glossy) 2.—Habitant, or Café plus Pellicule (with pellicles)	<i>In general:</i> The Guadeloupe coffee bean is glossy, hard, long, and has an even green color, somewhat grayish. It is of excellent quality. The Saints bean is superior. The Ordinary is a smaller, rounder, curved bean. Guadeloupe coffees are mostly sold as Martinique.
	Martinique (French)	Fort-de-France	Martinique Grades: Fine Green Common Green Good Commercial Common " Picked " Common	<i>In general:</i> The Martinique bean is green, long, somewhat thick, and is usually shipped in the silver skin. It is of fine quality, but commercially unimportant. Guadeloupe coffees are not infrequently sold as Martinique.
South America	Colombia		Colombians, <i>m n</i>	<i>In general:</i> The majority of Colombian coffees are greenish, (some are yellow and brown, depending on age), and are rich and mild in the cup. The fancy grades compare favorably with the world's best growths. They produce one-quarter more liquor of given strength than Santos coffees, and possess much finer flavor and aroma.
		Puerto Colombia Cartagena	Antioquia, <i>d</i> Medellin, <i>t &amp; m n</i>	Light to dark green; handsome rough roasters; best of Colombians; fine flavor and body.

<i>Grand Division</i>	<i>Country</i>	<i>Shipping Ports</i>	<i>State, or District, Market Names and Gradings</i>	<i>Trade Values and Cup Characteristics</i>
South America (Cont'd)	Colombia (Cont'd)	Buenaventura Puerto Colombia Cartagena	Caldas, <i>d &amp; m n</i> Manizales, <i>t &amp; m n</i>	Have a greater degree of acidity and less body than Medellins. While not possessing the style of Armenias, they are satisfactory coffees and widely used.
			Armenia, <i>m n</i>	A beany coffee, especially attractive in style; of full body in the cup.
			Puerto Colombia Cartagena	Cundinamarca, <i>d</i> Bogotá, <i>t &amp; m n</i> Girardot, <i>t &amp; m n</i> Honda, <i>m n</i> Tolima, <i>m n</i> Libano, <i>m n</i>
		Maracaibo	Santander, <i>d</i> Bucaramanga, <i>t &amp; m n</i>	Large bean, spongy and open, making a dull Java-style roast.
			Santander del Norte, <i>d</i> Cúcuta, <i>t &amp; m n</i>	Attractive in style and cup. (See Venezuela.)
			Ocaña, <i>t &amp; m n</i> Savanilla, <i>m n</i>	Sometimes sold as an imitation Bogota or Bucaramanga; but inferior in appearance and cup.
		Buenaventura	Valle del Cauca, <i>d</i> Sevilla, <i>m n</i>	Stylish coffee. Good flavor. Similar to Caldas.
			Cumbre, <i>m n</i>	The name signifies mountain top. These coffees are high-grown and have the same characteristics as Sevillas.
			Cali, <i>m n</i> Cauca, <i>m n</i>	These coffees are produced over a wide area in Valle del Cauca and generally are light in the cup.
			Huila, <i>d</i>	This department has comparatively small production and the coffees usually find their way to Girardot where they are shipped under that mark.
		Santa Marta	Magdalena, <i>d</i> Santa Marta, <i>t &amp; m n</i>	Full, solid, blue, washed bean, making a fancy roast, but too acid to be used straight.
		<i>Classes for All Colombians:</i>		
Café Trillado (natural or sun dried), Café Lavado (washed).				
<i>Gradings for All Colombians:</i>				
Supremo (selected large, flat, uniform beans without any mixture of the medium or "Caracol")				

COMPLETE REFERENCE TABLE

Grand Division	Country	Shipping Ports	State, or District, Market Names and Gradings	Trade Values and Cup Characteristics
South America (Cont'd)	Colombia (Cont'd)		beans), Extra (flat, medium sized bean with or without Caracol), Caracol (large and medium Caracol), Excelso (large and medium mixture of Supremo and Extra with or without Caracol), Segundo (small, sound bean, can be mixed with Peaberry), Consumo (small bean, can have slight imperfections, but without black beans or residues), Pasilla (small bean, can have slight imperfections and up to 50% of dark or black bean but without foreign matters or residue), Maragogipe (Maragogipe coffee). Coffee in parchment is graded as Primera (sorted and of uniform color), Segunda (unassorted), Maragogipe Primera (Maragogipe sorted and of uniform color), Maragogipe Segunda (Maragogipe unassorted). Approximately 80% of the exports to the United States are of the Excelso grade, the balance are of the other grades.	
	Venezuela	La Guaira Puerto Cabello Maracaibo	<p>Venezuela</p> <p>Caracas, <i>d</i></p> <p>Puerto Cabello, <i>d</i></p> <p>Cumana, <i>d</i></p> <p>Coro, <i>d</i></p> <p>Trujillo, <i>d &amp; m n</i></p> <p>Santa Ana</p> <p>Monte Carmelo</p> <p>Bocono</p>	<p><i>In general:</i> The coffee of Venezuela is greenish-yellow to yellow; large bean, ranging next to Santos in quality and price. It is mild or mellow in the cup. The unwashed, or <i>trillado</i>, comprises the bulk of the crop.</p> <p>Short, bluish bean, varying sizes, uniform in color, and making a light cinnamon roast, but containing quakers. They are usually light and acidic. The natural has a fair cup quality. The washed gives the best results in roast and cup.</p> <p>The washed is a handsome bean, but inferior in flavor to Caracas. The unwashed is flinty; fair roast, no special merit in cup.</p> <p>Valued just below Caracas.</p> <p>Valued a trifle below Rio of the same grade.</p> <p>A low grade, making a dull rough roast.</p> <p>Light in color and body.</p> <p>Light in color and body.</p> <p>Light in color and body; neutral flavor. Generally round, small to medium bean.</p>



## ALL ABOUT COFFEE

<i>Grand Division</i>	<i>Country</i>	<i>Shipping Ports</i>	<i>State, or District, Market Names and Gradings</i>	<i>Trade Values and Cup Characteristics</i>		
South America (Cont'd)	Venezuela (Cont'd)		Merida, <i>d &amp; m n</i>	The best of the Maracaibos. The washed makes a good roast, and has a peculiar delicate flavor much prized by experts. Very acid. It ranks among the world's best.		
			Tachira, <i>m n</i> (San Cristobal)	Formerly sold as Cúcuta, to which it is nearest in quality, appearance, and flavor.		
			Tovar, <i>m n</i>	Ranks between Trujillos and Tachiras. Fair to good body and flavor. Usually roast free from quakers.		
			Cúcuta, <i>t &amp; m n</i> Salazar, <i>m n</i>	Grown in Colombia. Rank with Tachiras and other fine Maracaibos. The natural makes a full roast. The washed is a stylish, large bean, a beautiful roaster, splitting open with irregular white center; sharply acid in the cup.		
			Angostura	A small bean, light in color and body, without much weight or character.		
			Carupano	A low grade valued at about the same as a Brazil coffee of similar grade.		
			British Guiana	Georgetown	Demerara, <i>m n</i>	<i>In general:</i> Not a commercial factor.
			Dutch Guiana (Surinam)	Paramaribo	Surinam, <i>m n</i>	<i>In general:</i> The production is limited and commercially unimportant.
			French Guiana (Cayenne)	Cayenne	Cayenne, <i>m n</i>	<i>In general:</i> Similar to Martinique. The production is limited and commercially unimportant.
			Brazil		Brazils, <i>m n</i>	<i>In general:</i> The coffees of Brazil are known in the trade as "Brazils" to distinguish them from "Milds." These coffees are described according to districts of origin and are commercially known by the names of ports. Growths of São Paulo, South Minas and North Paraná are known as Santos. Coffees from the State of Rio, part of São Paulo, and Espírito Santo, and the greater part of Minas, are known as Rios. Brazil exports average from 30% to 70% of the world's supply.

COMPLETE REFERENCE TABLE

<i>Grand Division</i>	<i>Country</i>	<i>Shipping Ports</i>	<i>State, or District, Market Names and Gradings</i>	<i>Trade Values and Cup Characteristics</i>
South America (Cont'd)	Brazil (Cont'd)	Santos	São Paulo, <i>d</i>	The largest coffee district, exports between 45% and 50% of the world's supply.
		Classes: Bourbon Santos, <i>m n</i>	Small bean, resembling Mocha, but making a handsomer roast with fewer quakers. In color it varies from dark to light green, and from yellow to a pale straw, often with a red center. True Bourbons are from the earlier crops. In the cup they are smooth and palatable without tang. If aged, new crop coffees usually have sharp acidity.	
		Flat Bean Santos, <i>m n</i>	Generally void of acid and rather flat taste. Larger bean than Bourbon Santos without curly characteristics.	
		Santos Rio de Janeiro Angra dos Reis	Minas Geraes, <i>d</i> Minas, <i>m n</i>	Minas coffee, in general, is similar to Santos, but has a more pronounced "sour" taste. Coffees produced in the southern part of the state adjoining São Paulo; are of excellent quality and comparable to the best of São Paulo. Various shades of green, medium to large bean. Some have a peculiar pungent flavor and aroma.
		Paranagua	Paraná, <i>d</i> Paraná, <i>m n &amp; t</i>	These coffees are usually described as groundy or earthy, but those grown at higher altitudes are of fairly good quality. Medium to large bean, pale green and greenish yellow to pale yellow; flat bean.
		Bahia	Bahia, <i>d, t &amp; m n</i>	Low grade, having a peculiar smoky flavor.
		Chapada, <i>d &amp; m n</i>	Light-colored, fair-sized bean; attractive roast, but no cup character.	
		Caravellas, <i>t &amp; m n</i>	Similar to Chapada.	
		Nazareth, <i>d &amp; m n</i>	Small bean, fair roast, undesirable cup.	

## ALL ABOUT COFFEE

<i>Grand Division</i>	<i>Country</i>	<i>Shipping Ports</i>	<i>State, or District, Market Names and Gradings</i>	<i>Trade Values and Cup Characteristics</i>
South America ( <i>Cont'd</i> )	Brazil ( <i>Cont'd</i> )	Bahia ( <i>Cont'd</i> )	Maragogipe, <i>d &amp; m n</i>	A variety of <i>Coffea arabica</i> ; extra large bean; elephantine roast; woody in the cup.
		Recife	Pernambuco, <i>d &amp; m n</i>	A "groundy" taste characterizes most Pernambucos but some of the better types are of higher quality, comparing favorably with Bahias.
		Rio de Janeiro	Rio de Janeiro, <i>d</i> Rio, <i>m n</i>	Generally harsh and pungent in cup. The bean is larger than Santos, ranging from light to dark green in color.
		Victoria	Espírito Santo, <i>d</i> Victoria, <i>t &amp; m n</i>	Large, dingy-green or brown bean making a roast free from quakers but muddy in the cup.
		Ceará	Ceará, <i>t</i> Cuaruaru, <i>m n</i>	Small, flinty, green bean; value like Santos of the same grade.
		Santos	Goyaz, <i>d</i>	Fair to large size bean, dark in color, attractive roast, but no cup quality.
			<i>Gradings for All Brazils</i> (Serviço Técnico, Rio de Janeiro)	
			1—no imperfections	5—46 imperfections
			2—4 imperfections	6—86 imperfections
			3—12 imperfections	7—160 imperfections
		4—26 imperfections	8—360 imperfections	
	Ecuador	Guayaquil	Ecuador Manabi, <i>d</i> Guayas, <i>d</i> Los Rios, <i>d</i> El Oro, <i>d</i>	<i>In general:</i> The Ecuador coffee bean is small to medium, pea-green in color, and not high grade. It resembles Ceará, and when old makes a bright roast. It is poor in cup quality and useful only as a filler. Not an important commercial factor.
	Peru	Callao	Peru Chauchamayo, <i>d</i> Choquisongo, <i>d</i> Cajamarca, <i>d</i> Perene, <i>d</i> Paucartambo, <i>d</i> Huanuaco, <i>d</i> Pacasmayo, <i>d</i> Amazonas, <i>d</i> Loreto, <i>d</i>	<i>In general:</i> The green coffee bean of Peru ranges from medium to bold in size, and from bluish to yellow in color. Lowland growths, not favorably regarded. Unimportant commercially.

COMPLETE REFERENCE TABLE

<i>Grand Division</i>	<i>Country</i>	<i>Shipping Ports</i>	<i>State, or District, Market Names and Gradings</i>	<i>Trade Values and Cup Characteristics</i>
South America (Cont'd)	Bolivia		Bolivia La Paz, <i>d</i> Apolobamba, <i>t</i> Yungas, <i>m n</i> Cochabamba, <i>d</i> Santa Cruz, <i>d</i> Sara Velasco Chiquitos Cordillera El Beni, <i>d</i> Chuquisca, <i>d</i>	<i>In general:</i> Bolivia's coffee, though of superior quality and sometimes compared favorably with Arabian growths, is an unimportant factor in international coffee trading, being used mostly for home consumption. A small quantity is shipped to Chile and Peru.
	Argentina		Argentina Salta, <i>d</i> Jujuy, <i>d</i>	<i>In general:</i> Argentina's coffee is grown chiefly for home consumption. Unimportant commercially.
	Paraguay		Paraguay Altos, <i>d</i> Asuncion, <i>d</i>	<i>In general:</i> Paraguay's coffee is all marketed in Asuncion, where it is sold as Brazilian coffee. It is not commercially important.
Asia	Yemen (Arabia)	Aden Hodeida	Mocha  Yemen Mattari, <i>d</i> (Mohtari)  Yaffey, <i>d</i>  Sharki, <i>d</i> (Shergi)  Sanani, <i>d</i>  Haimi-Harazi, <i>d</i> (Hemi or Heimah)  Anezi, <i>d</i> (Anisi)  Sharsh, <i>d</i> Menakha, <i>d</i> Hifash, <i>d</i>	<i>In general:</i> Arabian, or Mocha, beans are very small, hard, round, irregular in form and size; in color, olive green shading off to pale yellow. The roast is poor and irregular. In the cup they have a unique acid character, heavy body; in flavor, smooth and delicious.  From the Beni-Mattar country; the best; a yellow-green, translucent bean.  From the Yaffey country near Taiz; second best.  A long light yellow bean, from the east, "Esh Shark" a superior Mocha with a rich full body.  From the Sanaa region; a green bean. A grade lower than Sharki.  A quality green bean from a mountain near Mattari.  From the El Anz country. Pale yellow and very hard.  Superior qualities of the above due to different methods of curing.

## ALL ABOUT COFFEE

<i>Grand Division</i>	<i>Country</i>	<i>Shipping Ports</i>	<i>State, or District, Market Names and Gradings</i>	<i>Trade Values and Cup Characteristics</i>
Asia ( <i>Cont'd</i> )	Yemen (Arabia) ( <i>Cont'd</i> )		Remi, <i>d</i> (Reimah)	A poorer grade, reddish bean, from Djebel Remi.
			Bourai, <i>d</i> (Bura)	A poorer grade from Djebel Boura.
			Shami, <i>d</i>	A poorer grade from the north; Esh Sham.
			Yemeni, <i>d</i> (Taizi)	A poorer grade from the south; El Yemen.
			Maidi, <i>d</i>	A poorer grade from the port of Maidi.
			Abyssinian, <i>m n</i> Harar, <i>d</i> Djimmah, <i>d</i> Sidamo, <i>d</i>	Formerly known as Longberry Mocha, but still shipped through Aden <i>via</i> Jibuti. See Africa—Ethiopa (Abyssinia). Small bean, brownish in color, rather poor roast but winy in the cup and very acid. Djimmah is a slightly larger bean than Sidamo.
			<i>Gradings for All Mochas (Except Those for the United States):</i>	
			Mocha Extra—For all extra qualities as Yaffey, Anezi, Mattari, Sharki. Mocha No. 1—For Anezi, Mattari, Sharki; only perfect berries. No. 1A, same as No. 1, but with some dust. Mocha No. 2—Some broken and quakers. Mocha No. 3—Broken, quakers, and dust. Magrache—Triage or screenings.	
			<i>Harar Coffee Gradings for United States:</i>	
			1. Extra sifted; all large beans. 2. Shortberry Harar; all small beans. 3. Longberry Harar; grading between 1 and 2.	
	India	Madras Calicut Mangalore Tellicherry Tuticorin Bombay Cochin	Indias, <i>m n</i>	<i>In general:</i> The Indian coffee bean is small to large and blue-green in color. In the cup it has a distinctive strong flavor and deep color.
			Mysore, <i>d</i> Mysore, <i>t</i>	Mountain-grown, large, blue-green bean, heavy body. Quality almost equal to Nilgiri. Most important from volume standpoint.
			Madras, <i>d</i> Malabar, <i>m n</i> (Wynaad)	Small bean, solid and meaty; handsome roast, peculiar rich flavor.
			Nilgiri, <i>d &amp; m n</i>	Small to large bean with slight acidity in the cup; known for its fine blue color and good liquoring qualities.



Grand Division	Country	Shipping Ports	State, or District, Market Names and Gradings	Trade Values and Cup Characteristics
Asia (Cont'd)	India (Cont'd)		Madura, <i>d</i> (Palni Hills)	No marked characteristics.
			Salem, <i>d</i> (Shevaroy)	Same as Nilgiris.
			Anamallai, <i>d &amp; m n</i>	Next to Shevaroy in cup quality.
			Kanan Devan, <i>d &amp; m n</i>	Similar to Anamallai.
			Nelliampathy, <i>d &amp; m n</i>	About equal in quality to Mysore.
			Pulney, <i>d &amp; m n</i>	Similar to Mysore. Consumed mostly in India.
			Billigirirangan, <i>d</i>	Similar to Nilgiris.
			Coimbatore, <i>d</i>	Same as Nilgiris.
			Tellicherry, <i>d</i>	A good grade resembling Malabar; somewhat similar to Nilgiris.
			Coorg (or Kurg), <i>d</i>	A large, flat, dark green bean, thin in the cup; a lowland variety.
			Travancore, <i>d</i>	Similar to Nilgiris.
			Cochin, <i>d &amp; m n</i>	A native cherry.
			Bombay, <i>d</i> Kanara	Commercially unimportant.
			Bengal, <i>d</i> Chittagong	Commercially unimportant.
			Assam, <i>d</i>	Commercially unimportant.
			South Sylhet, <i>d</i>	Commercially unimportant.
	Burma	Rangoon	Burma Tavoy, <i>d</i>	Large spongy bean; grassy cup. Not a commercial factor.
			<p><i>Classes for All Indias:</i>                      1—Native cherry (sun dried and then hulled)                      2—Plantation (washed)                      Sizes: Nos. 1, 2 and 3; Peaberry and Triage</p>	
	Malay States (British)	Penang (Georgetown) Singapore	Straits Liberian, <i>m n</i> Straits Robusta, <i>m n</i>	<i>In general:</i> The coffee from the Malay States is mostly Liberian and Robusta and is not important commercially, although the Robusta variety promises to become an important factor.
			Perak, <i>d</i>	Most important of the Federated States coffees.

<i>Grand Division</i>	<i>Country</i>	<i>Shipping Ports</i>	<i>State, or District, Market Names and Gradings</i>	<i>Trade Values and Cup Characteristics</i>
Asia ( <i>Cont'd</i> )	Malay States (British) ( <i>Cont'd</i> )		Selangor, <i>d</i> Negri-Sembilan, <i>d</i> Bali, <i>d &amp; m n</i> Timor, <i>d &amp; m n</i>	Native state coffee. Nine states, Federation district coffees. From the island in Netherlands East Indies. From the island in Netherlands East Indies.
	French Indo-China	Haiphong	Indo-China Tonkin, <i>d</i> Annam, <i>d</i> Cambodia, <i>d</i> Cochin-China, <i>d</i>	<i>In general:</i> The coffees of French Indo-China, while comparatively new, give promise; but as yet are not commercially important. The original <i>arabica</i> plantings have been succeeded by <i>liberica</i> and <i>robusta</i> growths.
Malay Archipelago	Sunda Islands  Netherlands East Indies Sumatra	Padang (West Coast) Sibolga (West Coast) Medan (East Coast)         Padang	East Indies, <i>m n</i>  Sumatra    Ankola, <i>d &amp; m n</i> Sibolga, <i>t</i>  Mandheling, <i>d &amp; m n</i> Padang, <i>t</i>	<i>In general:</i> Included in this group are the best-known coffees from Sumatra, Java, Timor, Celebes, etc.  <i>In general:</i> Included among the coffees of Sumatra are several that are conceded to be the finest the world produces. The green beans are large, uniform, and vary in color from pale straw to deep mahogany, according to the ageing. They have a smooth, heavy body, the fancies possessing an almost syrupy richness. They are graded as Private Estate (washed or dry hulled) and Blue Bean (washed).  One of the finest and highest priced coffees in the world. Formerly a Government coffee. Large fat bean, making a dull roast. It has a heavy body and rich, musty flavor.  One of the finest and highest priced coffees in the world. Formerly a Government coffee. Yellow to brown, according to the ageing; large-sized bean; dull roast, but free from quakers. It is of heavy body, exquisite flavor and aroma.

<i>Grand Division</i>	<i>Country</i>	<i>Shipping Ports</i>	<i>State, or District, Market Names and Gradings</i>	<i>Trade Values and Cup Characteristics</i>	
Malay Archipelago (Cont'd)	Netherlands East Indies Sumatra (Cont'd)	Sibolga Medan	Toba, <i>m n</i>	Same as Ankola coffee. Grows along Toba Lake between Medan and Sibolga. New native plantations.	
			Liberian, <i>m n</i>	<i>Liberia excelsa</i> . Only small quantities.	
		Pedang	Interior, <i>m n</i>	Degenerated Mandheling coffee. Scandinavian market only.	
		Palembang Telok-Betong	Palembang, <i>d &amp; m n</i> Lamong, <i>d &amp; n</i>	<i>Robusta</i> variety only. Smaller than the Padang bean; light color, strong cup.	
		Palembang Telok-Betong Benkoelen Padang Sibolga Medan	Robusta, <i>m n</i>	Small, yellowish-green round bean; quality approximately that of middling Arabian, ranking a little under good average Santos. Natural, poor roast. Washed, good roast. Thin cup. Used as fillers.	
		Java	Batavia Semarang Soerabaja	Java, <i>m n</i>	<i>In general</i> : Java coffees do not compare with Sumatras in quality. They are smaller in the bean, with a grassy flavor in the cup. Blue to pale yellow, short round bean. The washed makes a good smooth roast, light in the cup.
				Robusta, <i>m n</i>	Small, yellowish-green, round bean; quality approximately that of middling Arabian, ranking a little under good average Santos. Natural, poor roast. Washed, good roast. Thin cup. Used as filler.
	Timor (Dutch & Portuguese)		Macassar Timor-Dilly	Timor, <i>m n</i>	A hard coffee with heavy body.
	Celebes (Dutch)	Macassar	Celebes, <i>m n</i>	<i>In general</i> : With the exception of the Menado and Boengie products, the coffees grown in the Celebes have little merit and are of inconsiderable importance. European market.	
			Boengie, <i>m n</i>	<i>Coffea arabica</i> . Has same characteristics as Mandheling and Ankola. Heavy body.	
		Menado	Menado, <i>m n</i>	Highest priced coffee for Europe. <i>Coffea arabica</i> .	

## ALL ABOUT COFFEE

<i>Grand Division</i>	<i>Country</i>	<i>Shipping Ports</i>	<i>State, or District, Market Names and Gradings</i>	<i>Trade Values and Cup Characteristics</i>
Malay Archipelago (Cont'd)	Borneo British North Sarawak Dutch	Sandakan Kuching Banjermasin	Borneo, <i>m n</i>	<i>In general:</i> The coffees of Borneo are mostly Liberian growths and are not a trade factor.
	New Guinea (Dutch)	Ternate (Moluccas) Dorey	New Guinea, <i>n m</i>	<i>In general:</i> These coffees are of the mild variety, but the production is commercially unimportant.
Melanesia	New Caledonia (France)	Noumea	New Caledonia La Foa	A fair Arabica coffee, but commercially unimportant.
	New Hebrides (Great Britain and France)  Efate	Vila	New Hebrides	A fair Arabica coffee, but not a trade factor.
Micronesia	Samoa Islands Tutuila	Pago Pago (U. S.)	Samoa	Commercially unimportant.
	Fiji (British) Vita Levu	Suva	Fiji	Medium-sized green bean; grassy cup. Not a trade factor.
	Tonga (Friendly Islands) Tongatabu	Nukualofa	Tonga	For local consumption only.
Philippine Islands (U. S.)	Luzon	Manila	Manila	No production for export.
Marianas or Ladrone Islands	Guam (U. S.)	Apra	Guam	No production for export.
Oceania Polynesia	Hawaiian Islands (U. S.)	Honolulu (Oahua) Hilo Kailua	Hawaii   Kona, <i>d</i> Hamakua, <i>d</i>	<i>In general:</i> Hawaiian coffee is a large bean, blue-green to yellow-brown in color; handsome roaster, fine smooth flavor.  Large, blue, flinty bean, mildly acid; striking character.
	Society Islands (French)	Papeete	Tahiti	A fair coffee, but not a trade factor.
Australia	Papua	Porto	Papua, <i>d</i>	<i>In general:</i> The coffee is Robusta growth. For Australian consumption.

COMPLETE REFERENCE TABLE

229

<i>Grand Division</i>	<i>Country</i>	<i>Shipping Ports</i>	<i>State, or District, Market Names and Gradings</i>	<i>Trade Values and Cup Characteristics</i>
Africa	Egypt	Alexandria	Egyptian, <i>m n</i>	<i>In general:</i> Coffees from the upper Nile region, Kaffa Land, Anglo-Egyptian Sudan, and Nubia are generally spoken of as Egyptians. They have some Mocha characteristics, but are not important commercially.
	Anglo-Egyptian Sudan	Suakin Alexandria (Egypt)	Nubian, <i>m n</i>  Berber, <i>d</i>	Small, flinty, pale-green, oval bean; heavy body; rich flavor.  Some superior drinking coffees come from this district.
	Eritrea (Italy)	Massowah	Abyssinian, <i>m n</i>	The coffee is of the Abyssinian type, but the output is not an important trade factor.
	Somaliland French	Jibuti	Harar, <i>d, t</i> Abyssinian, <i>m n</i>	These coffees are not grown in French Somaliland, but come from Abyssinia to Jibuti and Aden for export to Europe and America. See Ethiopia.
	British	Berbera Zeila	Harar, <i>d, t</i> Abyssinian, <i>m n</i>	Grown, as above, in Ethiopia.
	Italian	Mukdishu	Benadir, <i>d &amp; m n</i>	Abyssinian type, but not an important trade factor.
	Ethiopia (Abyssinia)	Jibuti (French Somaliland) Zeila	Harar, <i>d, t</i> Abyssinian, <i>m n</i>	<i>In general:</i> Harar coffee is more carefully cultivated and cured than the Abyssinian, which is its inferior.
		Berbera (British Somaliland)	Harar, <i>d, t</i> Harari, <i>m n</i>	The original Mocha Longberry. Large, long blue-green to yellow bean. (Graded No. 1 or No. 2, according to size) roasting with few quakers, similar to Mocha, having an excellent flavor but not quite so delicate.
		Massowah (Eritrea)		
		Aden (Arabia)	Dire-Daoua, <i>t</i>	Railway trading center for Harari and Abyssinian coffees.
			Abyssinia Kaffa, <i>d</i> (Gomara)	The native coffee grown wild in this district has little commercial importance. The bean is dark gray, and it has a groundy flavor.
		Bonga, <i>t</i>	Trading center for Abyssinia.	



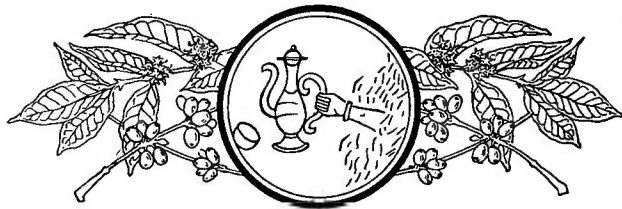
## ALL ABOUT COFFEE

<i>Grand Division</i>	<i>Country</i>	<i>Shipping Ports</i>	<i>State, or District, Market Names and Gradings</i>	<i>Trade Values and Cup Characteristics</i>
Africa (Cont'd)	Ethiopia (Cont'd)		Djimmah, <i>d</i>	Trading center for Abyssinia.
			Shoa, <i>d</i> Addis-Ababa	Mostly Abyssinian growths are exported from this trading center to Harar or Dire-Daoua.
	Kenya	Mombasa	Nairobi, <i>d &amp; t</i> Kaimosi, <i>d</i> Kipkarren, <i>d</i> Kiambu, <i>d</i> Nyeri, <i>d</i> Solai, <i>d</i> Sotik, <i>d</i> Thika, <i>d</i>	Bourbon character. Medium to small bean; green to greyish green; very fine to good liquor.
	Uganda	Mombasa	Uganda Mount Elgon, <i>d</i> Bugishu, <i>d</i>	Arabica—large bean, greenish to brownish green; poor to fair liquor.  Native grown—Robusta known as "Native," Arabica known as "Plantation." Greenish to brownish green; poor liquor.
	Tanganyika	Mombasa Dar-es-Salaam Tanga	Kilimanjaro, <i>d</i>	Arabica; fair to large flat bean; green to greyish; good liquor.
			Arusha, <i>d</i> Moshi, <i>d</i>	Arabica; medium Bourbon style bean; greenish to greyish; good to fine liquor.
			Usambara, <i>d</i>	Arabica; bold long bean; greyish green to brownish; medium to fair liquor.
			Bukoba, <i>d &amp; m n</i>	Native grown. Robusta known as "Native," Arabica known as "Plantation"; greenish to brownish green, poor liquor.
	Nyasaland Protectorate (British)	Chinde (Portuguese East Africa)	Nyasaland Shire Highlands, <i>d</i> Blantyre, <i>d</i>	Some high-grown and of fine quality. Similar to Kenya.
	Rhodesia (British)	Beira (Portuguese East Africa)	Rhodesia	For local consumption. Not a trade factor.
Angola (Portugal)	Loanda	Angola Cazango, <i>d</i> Golungo, <i>d</i>	Medium-size bean, brownish color, strong in the cup.	
		Encoje, <i>d, m n</i>	Light weight, dark brown Robusta hybrid; strong in the cup.	
Belgian Congo	Dar-es-Salaam	Urundi, <i>d</i> Kivu, <i>d</i> Ruanda, <i>d</i>	Mainly Arabica, similar to Kenya but rather poorer quality; mainly greyish green.	

COMPLETE REFERENCE TABLE

<i>Grand Division</i>	<i>Country</i>	<i>Shipping Ports</i>	<i>State, or District, Market Names and Gradings</i>	<i>Trade Values and Cup Characteristics</i>
Africa (Cont'd)	French Congo	Loango Libreville Duala	Loango, <i>d, m n</i>	Similar to Angola.
	Madagascar (French)	Tamatave	Madagascar	Robusta ( <i>Canephora</i> species) of good character. Small quantity of Liberia, poor character.
	French West Africa	Bingerville	Ivory Coast, <i>d</i>	Liberia ( <i>excelsa</i> species). Some Arabica coming into production.
	Portuguese West Africa	Luanda Porto Amboim Ambrizette	Cazengo, <i>d</i> Encoge, <i>d</i> Ambriz, <i>d</i> Novo Redondo, <i>d</i> (Amboim)	Coffees are described by the names of the districts in which they are grown. No special cup characteristics other than those of Robusta coffee. All coffee exported except qualities below No. 7 which are consumed in Portugal.
	S. Thomé Island	S. Thomé	S. Thomé, <i>d</i>	Coffees known as S. Thomé ( <i>Arabica</i> ) and S. Thomé ( <i>Liberia</i> ). All the Arabica coffee is consumed in Portugal and is of very high class. Liberia is chiefly exported to Norway and is favorably compared with Surinam.
	Cape Verde Islands		Sto. Antão, <i>d</i> Fogo Island, <i>d</i>	Coffees known as Sto. Antão and Fogo and wholly consumed in Portugal. Very small crop.
			Scattered	Liberia, several species.
	French Equatorial Africa	Duala  Loango	Cameroons, <i>d</i>  French Congo, <i>d</i>	Liberian and some good Robustas.  Liberian, Robusta and some Arabica. Unimportant.
	Nigeria (British)	Lagos	Nigeria	Commercially unimportant.
	Gold Coast (British)	Accra	Gold Coast	Not a commercial factor.
	Liberia	Monrovia	Liberian, <i>m n</i>	Large, brown bean; big, handsome roaster; strong in cup. For local consumption.
	Sierra Leone (British)	Freetown	Sierra Leone	<i>C. stenophylla</i> , a native growth. Not a trade factor.
French Cameroons	Konakry	Guinea, <i>m n</i>	Commercially unimportant. A hybrid.	

<i>Grand Division</i>	<i>Country</i>	<i>Shipping Ports</i>	<i>State, or District, Market Names and Gradings</i>	<i>Trade Values and Cup Characteristics</i>
Africa ( <i>Cont'd</i> )	Portuguese Guinea	Bissao	Guinea, <i>m n</i>	Commercially unimportant.
	Fernando Poo (Spanish)	San Juan	Fernando Poo, <i>d</i>	A Robusta growth.
	Réunion, formerly Bourbon (French)	St. Denis	Bourbon, <i>m n</i>	Nearest to Mocha in character (q. v.). Round and pointed bean, pale green or pale yellow. Not a trade factor.
	Mauritius (British)	Port Louis	Mauritius	Similar to Bourbon. Medium light green, full body, mild and mellow flavor. Not a trade factor.



## CHAPTER XX

### FACTORY PREPARATION OF ROASTED COFFEE

THE COFFEE ROASTING BUSINESS—WHOLESALE ROASTING EQUIPMENT—CLEANING AND MIXING THE GREEN COFFEE—ROASTING BY COAL, COKE, GAS, OIL AND ELECTRIC HEAT—COST OF ROASTING—COFFEE SHRINKAGE TABLE—ROASTING EFFICIENTLY—MODERN WHOLESALE GRINDING—THE BLENDING OF COFFEE—SUGGESTIONS FOR BLENDS—COFFEE CUPPING PROCEDURE—THE PACKAGING OF COFFEE—COFFEE ADDITIONS AND FILLERS—TREATED COFFEES—DRY AND LIQUID EXTRACTS

THE development of the infusion qualities of coffee by a heat treatment called roasting, which transforms the prosaic "green beans" into brown nuggets of delightful fragrance, follows a long series of coffee-trade operations which have world-wide importance.

Since most people who taste a well-made cup of coffee are pleased with it and are disposed to continue its use, a consumer demand has resulted which is so large and so dependable that the growing of coffee has spread to lands of suitable climate all around the world. An enormous trade between tropical and non-tropical lands has resulted, as well as intensive studies by agronomists, chemists, engineers, mechanics, trade organizers, economists, and government officials; all aiming to solve important and baffling problems such as are met in the competitive production and distribution of any widely used plant product.

#### *The Coffee Roasting Business*

There are many reasons why the roasting of coffee cannot be performed in the growing country, and thus permit the export of goods which are ready for consumer use. A sufficient reason might be that the greater bulk of the roasted coffee, and the utterly different packing required, would cause a great increase in transport costs. But the fundamental reason is that while green coffee needs no hurrying to its final market, the roasted beans must reach

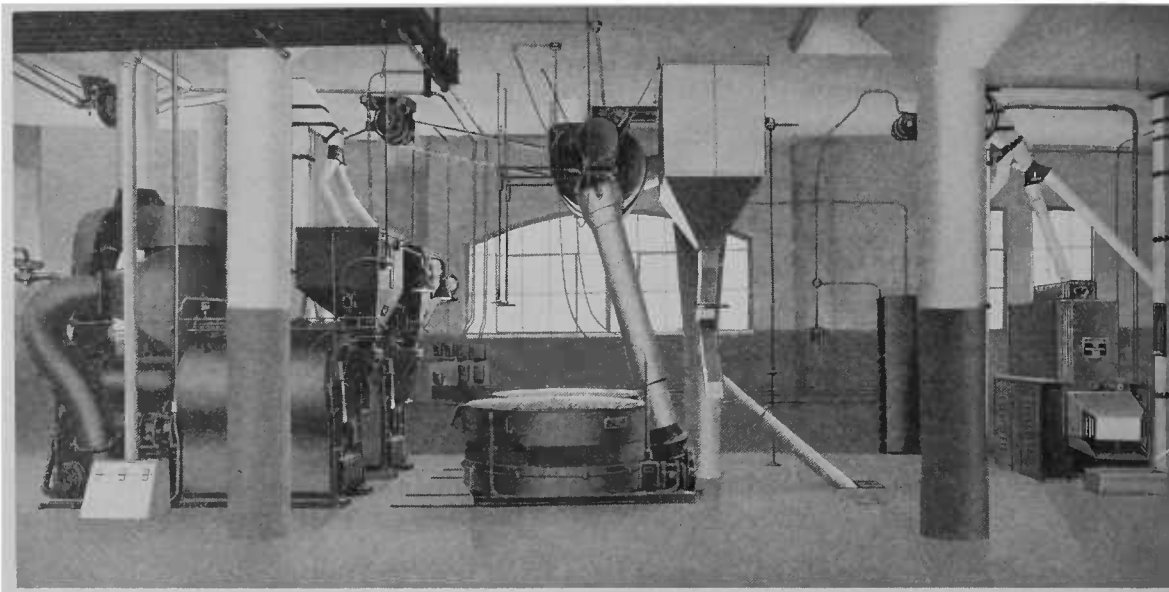
the consumer quickly if all the cup-flavor possibilities are to be realized. Modern devices for sealed and vacuumized packing of the coffee, after roasting or after grinding, delay the loss of aroma but cannot completely prevent it.

In theory, therefore, each household, restaurant, or hotel should be equipped with roasting and grinding apparatus of suitable capacity. But practically, at least in the United States, the roasting of coffee has seldom been done by any considerable part of the consumers. Today, even the grinding operation is being very largely thrown back on the coffee retailer or the wholesale roaster, in line with the transfer of many other old-time kitchen jobs to the increasingly efficient modern food factories.

Large-scale roasting is really an old business in the chief coffee-consuming countries; large-scale grinding has been added to most United States plants; and there has been everywhere a constant development of improved factory machinery, now largely guided by expert technical research into the mysteries of the coffee bean and the conditions under which its unique flavor can be most fully developed and conserved.

If the factory-roasted product, either whole-bean coffee or ground, can be delivered to the consumer without undue loss of infusion value, there are fundamental advantages in this wholesale preparation of goods so steadily in demand.

The mere fact of buying and manufacturing on a large scale suggests at once



A MODERN AMERICAN COFFEE-ROASTING ESTABLISHMENT

View of the roasting room on the top floor of the Chicago plant of the Grand Union Tea Company. Coffee is conveyed by gravity to the lower floors.

that certain economies result inevitably. But the real benefits of a big business relate particularly to the possibilities of making it an ideal organization, with expert technique and sound judgment in every department. Then green coffee selections, for establishing desirable blends and maintaining them, would be based on full knowledge of past and present market conditions and future probabilities; every step in factory operations would receive similar expert attention, with repairs or replacements never delayed unduly; and the sales and advertising department would function successfully without making false claims or stating coffee untruths. It seems safe to say that publicity which aims to extend the use of coffee in general, by giving the public real coffee facts and correct infusion advice, has never yet harmed the advertiser's coffee-roasting business.

A large part of all the coffee consumed in the United States is roasted in well-equipped factories; so most of the nation's coffee drinkers never see any green coffee at all, and their slight acquaintance with whole-bean roasted coffee is lessening rapidly.

A "wholesale plant" now indicates one that has machinery for roasting at least two bags of green coffee (120 kilos or 264 pounds) at a time; and nearly all the larger plants are equipped with roasters of four-bag capacity. Plants treating from

fifty to one hundred and fifty bags per day are the most common, but the daily capacity runs up to several thousand bags. The arrangement is suited to a particular building and to the particular business, so that the goods can be handled from start to finish with minimum expense for floor space, labor, power, etc.

Whenever possible the roasting machinery is placed in the top story of the building because good light and a fairly high ceiling are required, and both may always be obtained in a top story location by making, if necessary, some skylight or penthouse arrangement; also because outdoor connections from fans and collectors are easily carried through the roof, whereas bringing them from a lower story means less efficiency and troublesome installation; and again because top story roasting permits an advantageous use of gravity in the transfer of goods.

All the most important mechanical advantages of the best large plants may be realized also by the smallest "wholesale" producer, if his single machine is operated on the same correct roasting and grinding principles. There are many one-roaster plants, of this modern sort, competing successfully with a great range of larger producers.

Compared to other countries the amount of "retail roasting" in the United States has always been small, and it has lessened in recent years, though one-bag roasts are



put in this category. There is some demand for small roasters among retailers catering to foreign-born groups in the United States. There are some Italian grocers, in New York and other cities, who have pleased their trade by installing sample roasters—standard coffee-trade models, with two, four or six cylinders—in which a customer's half-pound of coffee, selected from the dealer's green stock, is roasted to the desired black-brown degree. Without such shop facilities the coffee of these consumers would be badly roasted at home—agitated in a pan or sieve over some sort of burner.

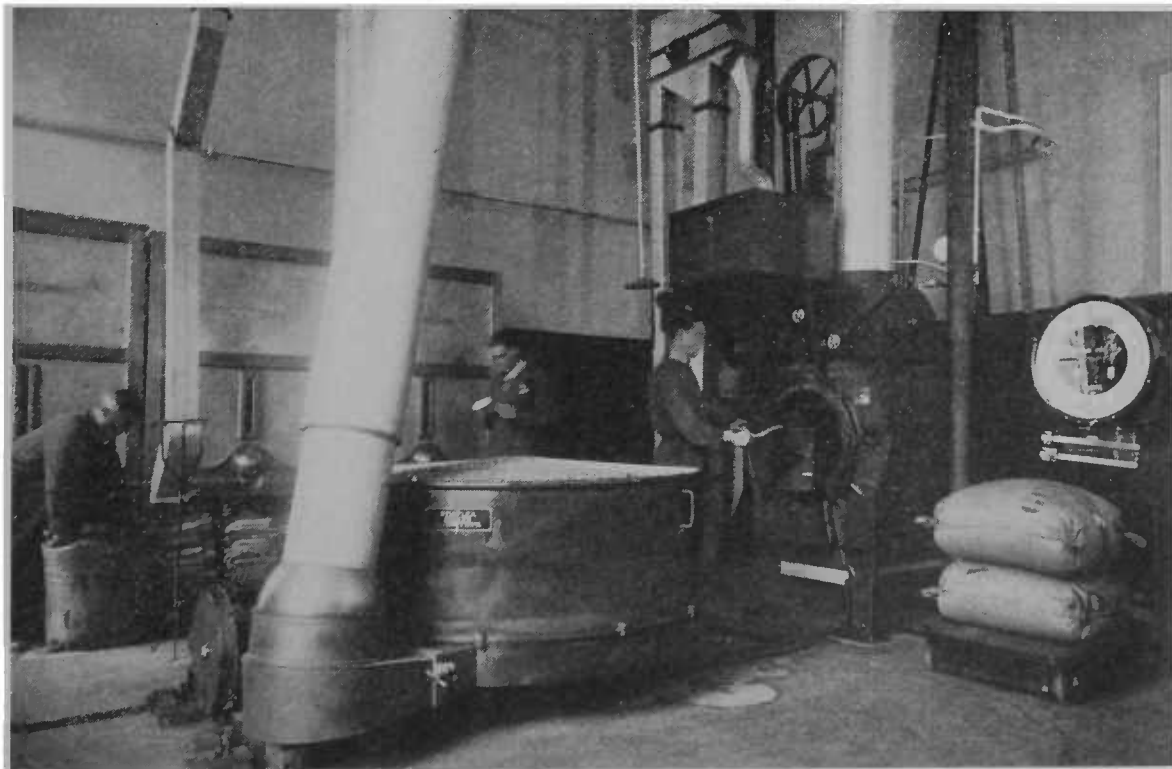
The Royal Electric Fixture Corporation, Hornell, N. Y., makes a small-capacity, electrically operated coffee roaster, which is used to some extent in the United States for installation in retail stores. The capacity of these roasters runs from fifteen to seventy-five pounds, using gasoline, natural, or artificial gas as fuel.

In Great Britain, in spite of a general preference for tea as the indispensable non-alcoholic beverage, there has been since early coffee-house days a real interest in coffee also. Grocers' assistants, who fit themselves seriously for that profession, study all varieties of coffee as well as tea;

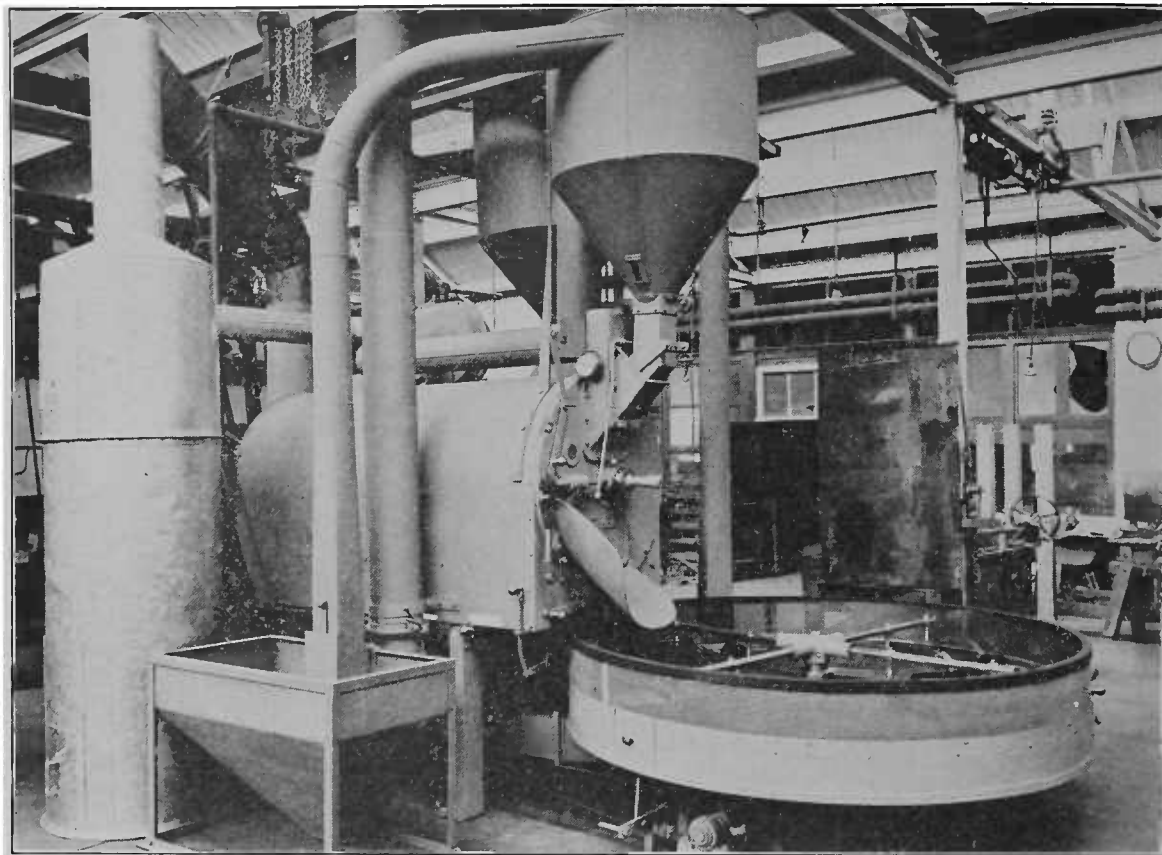
and they are usually expert operators of the roasting apparatus, of small capacity and attractive design, which continues to play a very important part in coffee merchandising.

The Uno Company of London, machine builders and electricians, have for many years specialized in this small-scale roasting equipment. They offer hand-turned cylinders to roast from a half-pound to seven pounds, and complete motor-driven outfits for roasting and cooling batches of 7, 14, 28, and 56 pounds (all related to the British 14-lb. stone and 112-lb. cwt). The heating is either by gas or electricity, the latter being claimed to cause less loss in weight. The burner or heating element is inside the roaster cylinder.

Roasting on a large scale remains unimportant compared to these extensive fresh-roast activities, notwithstanding the fact that England has become much more coffee conscious through her increasing prestige as a raw coffee producer in the Kenya colony of East Africa. Perhaps the largest coffee-roasting plant in England is operated by J. Lyons & Co., Ltd., forming part of their model factories at Greenford, which supply the famous chains of Lyons restaurants and hotels.



AMERICAN COFFEE-ROASTING EQUIPMENT IN THE PLANT OF AMEDEO S. CANESA, GENOA, ITALY



AN ENGLISH-BUILT COFFEE-ROASTING AND GRINDING INSTALLATION  
Roasting and grinding plant of the Cooperative Wholesale Society, at Manchester.

Food products are largely sold in English cities through cooperative stores, and an interesting coffee roasting plant was installed in Manchester some two years ago by the Cooperative Wholesale Society, which has a large warehouse there. According to a description in *The Producer*, the roaster capacity is 350 pounds, or 1,050 pounds per hour; air suction puts green coffee into the feed hopper and transfers the roasted coffee to hoppers over two "heavy" grinding mills. The article hails the plant as a triumph of English industrial engineering, and must have aroused the interest and patronage of all the coffee drinking cooperators.

Visitors to Great Britain have been notoriously critical of the beverage served there as coffee, and some even dare to find fault with the tea also. In the brewing of both there persists the old practice of boiling, to extract the goodness of the powder or the leaf, whereas in other countries experts have been learning that all the real good of tea leaf or coffee grain is quickly dissolved by water at less than boiling

temperature. No end of coffee brewing contrivances have been patented in Britain (often called "coffee machines" in Scotland) and no end of coffee essences, extracts, powders, etc.

#### *Roasting in Continental Europe*

In the countries of continental Europe the coffee-roasting business has developed in various ways. Little Holland, with her great East Indian plantations and worldwide trade, has been strongly coffee-minded for a long time. Belgium and her big neighbor, France, also are coffee producing traders, and they discourage by import taxes the use of coffee which is not of national origin. Many of the other countries impose tariffs intended to lessen the entry of all kinds of coffee and have shrewdly encouraged the use of home-grown substitutes, or surrogates, such as cereals, chicory, figs, malt, etc., so there are large quantities of these goods, either for mixing with or replacing coffee, which are skillfully produced by correct roasting treatment. This "coffee" manufacture is

usually subject to well-enforced state or local regulations, which relate also to the addition of sugar to the roasted product, or caramelizing.

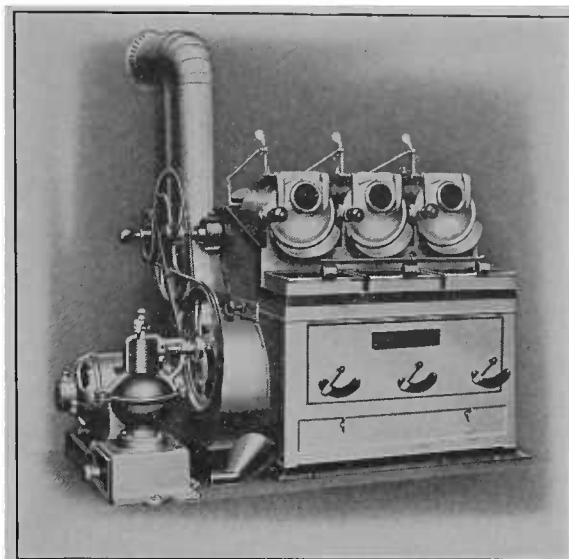
Though roasting on a small scale predominates in many parts of Europe there is nevertheless a broad market for large-capacity machines, particularly in Germany, where much of the apparatus is made; in France; and in Scandinavian countries. The importance of "quick roasting" seems to be stressed by European machinery firms and the coffee trade in general.

The use of coffee in Italy is restricted by heavy import taxes; and the government urges the use of native wine and beer. But there is a good deal of roasting in small machines, often outside shop doors—which is not bad coffee advertising. The wholesale roasting plants are relatively few, but a number of excellent installations have been made in recent years. One of them is operated by the Cirio Company, famous packers of food products, with many factories in the Naples district and elsewhere; and they have developed vacuum-packing methods for coffee based on research in their own laboratories.

A smaller plant at Genoa belonging to Amedeo S. Canessa, is illustrated on page 235. And at Trieste there is another interesting installation which was described at some length more than two years ago in the marine publication *Il Mare*. This plant, which seems by the illustrations to have German-made apparatus, is devoted especially to supplying high-grade coffee to the big Italian trans-Atlantic liners. The large roaster has a circular cooler alongside, from which the batches are mechanically transferred to four bins hung to the high ceiling; and they in turn supply a four-division measuring hopper on top of the grinding mill. Special attention is called in the article to the vacuum-packing department, where the coffee is put in plain tin cans of a kilogram capacity, "secure from any deterioration for at least three months." This organization is named "Excelsior," or, more fully, "Excelsior Company for the Roasting and Conservation of Coffee."

#### *Wholesale Roasting Equipment*

The indispensable coffee operations are roasting and cooling; and in practically all



A GERMAN COFFEE SAMPLE ROASTER

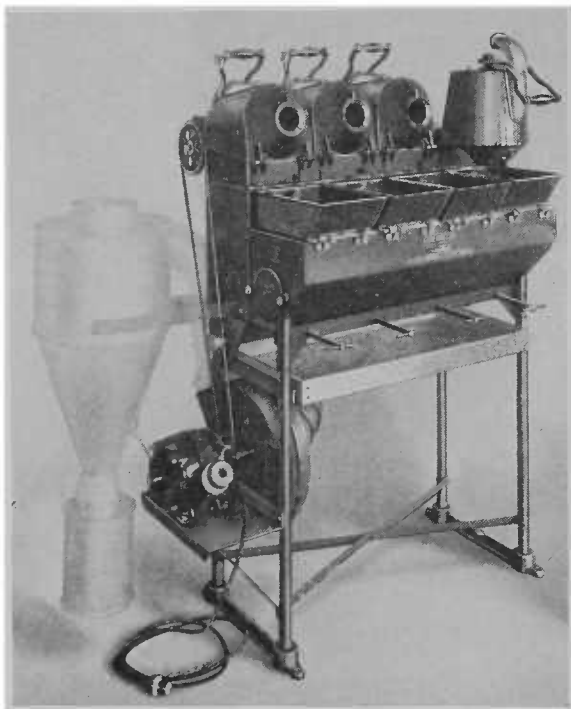
The "Mignon" electrically-driven gas or electric machine, with smoke suction and sample grinder (left). Each cylinder is heated separately and turns out a roast in six minutes.

modern plants the cooling is followed by another air-suction operation called "stoning," which removes any stones or other hard material that would damage a grinding mill. The best commercial cleaning of the green coffee usually leaves in every bag a few small stones and other bits of hard and relatively heavy foreign material. These can be separated by gravity, and very much better after the coffee is roasted, because it is then not only lighter but a good deal more bulky.

Besides the combined apparatus for roasting, cooling, and stoning operations, the plant may have machinery for treating the coffee both before it is roasted and after it leaves the stoner.

The treatment of green coffee is much simpler than it used to be, for most coffees now come to market better cleaned and graded; and as most consumers now prefer to buy ground coffees, uniform whole-bean size is less important. The old time "separator" and "milling-machine" installations have practically disappeared from American plants; for their use related mostly to superficial improvement of the green coffee and not to any development of finer and more uniform cup quality—except in the removal of dust and other foreign matter.

The green coffee mixer, however, for giving perfect uniformity to a much larger batch than can be roasted at one time, has steadily gained in favor. It equalizes vari-



AMERICAN COFFEE SAMPLE ROASTER

Four-cylinder, electrically-driven Burns outfit, with smoke suction from cooling fan to rear of each cylinder. Dust-collecting device can be connected, as shown at left.

ations which are bound to occur among different bags of the same chop of green coffee, thus helping the manufacturer of a popular brand of roasted coffee—well-packed, well-named, well-advertised and distributed—to attain more nearly the desired goal of putting goods of identical cup quality in every package.

A detailed list of the pieces of apparatus in a coffee-roasting installation does not enable one to make a correct appraisal of the plant's excellence. For, although there are somewhat standardized groupings of certain machines, each installation has to meet the special problems relating to the particular business and the factory space available. Experienced engineering skill must come in as a vital and really tangible constituent if the whole installation is to be rated high among plants of proved efficiency. Rigid exactness is essential to good engineering but elements of flexibility must be deliberately included so that alterations may be feasible and not over-costly whenever expansion is necessary or when expert management sees advantages in changing a certain manufacturing or marketing procedure. Change shows life, and wise change shows health.

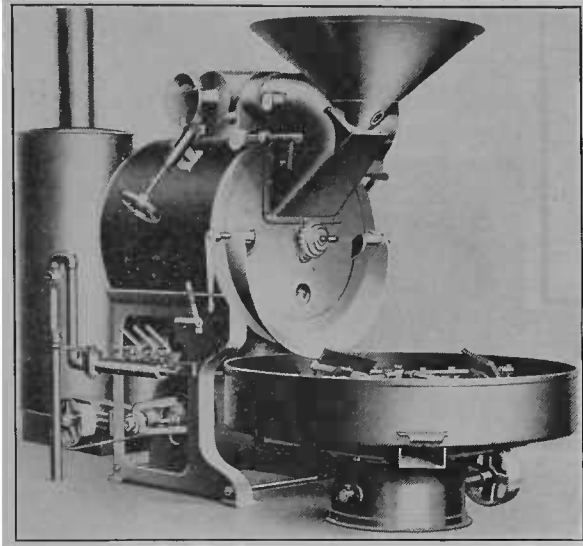
Except in a business which merely roasts coffee belonging to someone else—performing the work called “trade roasting” at so much per bag—the plant must have adequate facilities for testing accurately the roasting qualities of green coffee before purchase is made. This “sample-testing” work is the real foundation of correct buying; which means the ability to select, within determined price limits, the best available green coffee for maintaining the cup-flavor characteristics of blends which have proved successful. Jabez Burns used to say long ago, “You can succeed with good coffee or bad if always the same, but you cannot succeed with brands of coffee that vary.” In principle, at least, this has always seemed a wise statement; and maintaining whatever cup value certain groups of consumers consider “good” still appears to be essential for holding their trade.

In Great Britain the limited demand for large-plant equipment has not permitted much profitable production. Several manufacturing firms have been merged in the present Whitmee Engineering Company, London, who offer a complete line of coffee roasting and grinding apparatus, including the “Simplex” roaster; also tea machinery, etc. Their Manchester installation illustrated in this chapter is described by them as “a 3-cwt. capacity Whitmee indirect-flame coffee roasting plant, with automatic suction feed, rotary cooler, stoner, and chaff arrester.” Roasters of the old Tupholme, Faulder, and Morewood models are



AMERICAN REVOLVING COFFEE TESTING TABLE

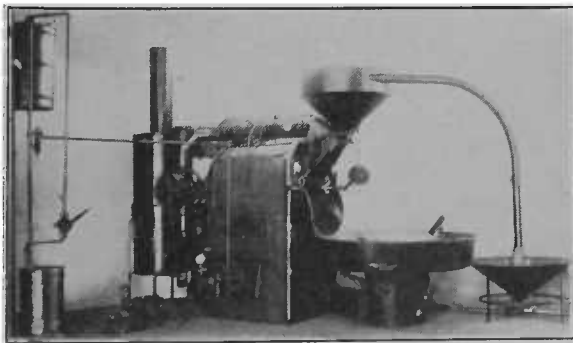
Both the scale and the marginal tray can be moved independently of the table top.



THE "PROBAT" GAS-HEATED RAPID ROASTER  
German machine with capacity from 22 to 120 kilograms.

now considered obsolete, and have been largely replaced with more modern apparatus.

In continental Europe the manufacturers of coffee-roasting machinery are faced with conditions quite different from those in the United States, and the development of their machines has differed accordingly. The old-time globe roasters (Kugelbrenner in German) have advantages for treating certain coffee substitutes and are particularly useful for adding a sugar coating or "caramelizing." Machines of this type are still largely used in Europe, some small and simple like the old models, but many of much larger capacity and of radically improved design. These roasters and a great variety of new models are produced mainly in Germany and France; and more largely in Germany, as her geographical position favors export to other parts of Europe. Wholesale roasting plants in the

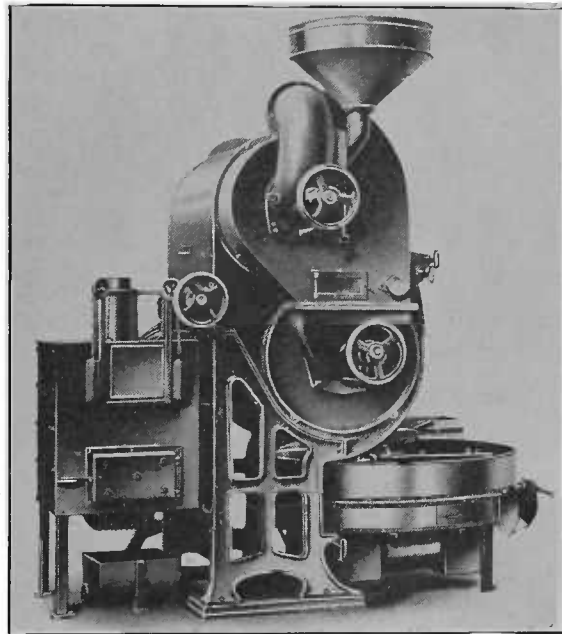


"PROBAT" ROASTER, WITH OIL-HEATING SYSTEM

principal cities have for a long time been equipped with excellent modern machines, arranged with labor-saving connections suited to each installation.

Perhaps the oldest coffee machinery concern in Germany (founded in 1868) is the Emmerich Machine Works and Iron Foundry at Emmerich on the Rhine, whose apparatus is identified by the name "Probat" (proved, tested). They have recently made an interesting resumé of coffee trade matters from which are taken—not literally or in full—the following statements:

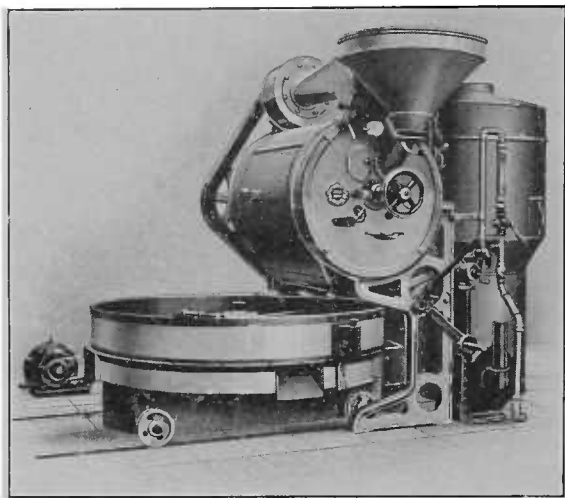
The large roasting plants of European countries have less automatic features than installations of similar capacity in the United States, since nearly all the wholesale concerns in Europe have to produce many more coffee blends than is usual in America. A further complication, in Germany particularly, is the practice of re-sorting the roasted coffee by hand. Roaster design has changed considerably as regards heating details. In France, heating by coke is



GERMAN "CORONA" ROASTING MACHINE  
The "Corona," with two roasting drums. The upper drum pre-heats the coffee and the lower one completes the roast. Capacity is up to 180 kilograms.

still preferred as few towns have a gas supply at reasonable rates. In Germany and Scandinavia the gas rates for industrial purposes are very moderate, which has made it possible for the wholesale plants to replace coke-fired machines with more rapid roasters employing gas-heating methods. Electric heating is used only where no gas is available and particular cleanliness is required; and these roasters are made only up to 60 kilogram capacity. Recently crude-oil heating has been widely adopted and found satisfactory, especially for the roasting





THE GERMAN "IDEAL-RAPID" ROASTING MACHINE

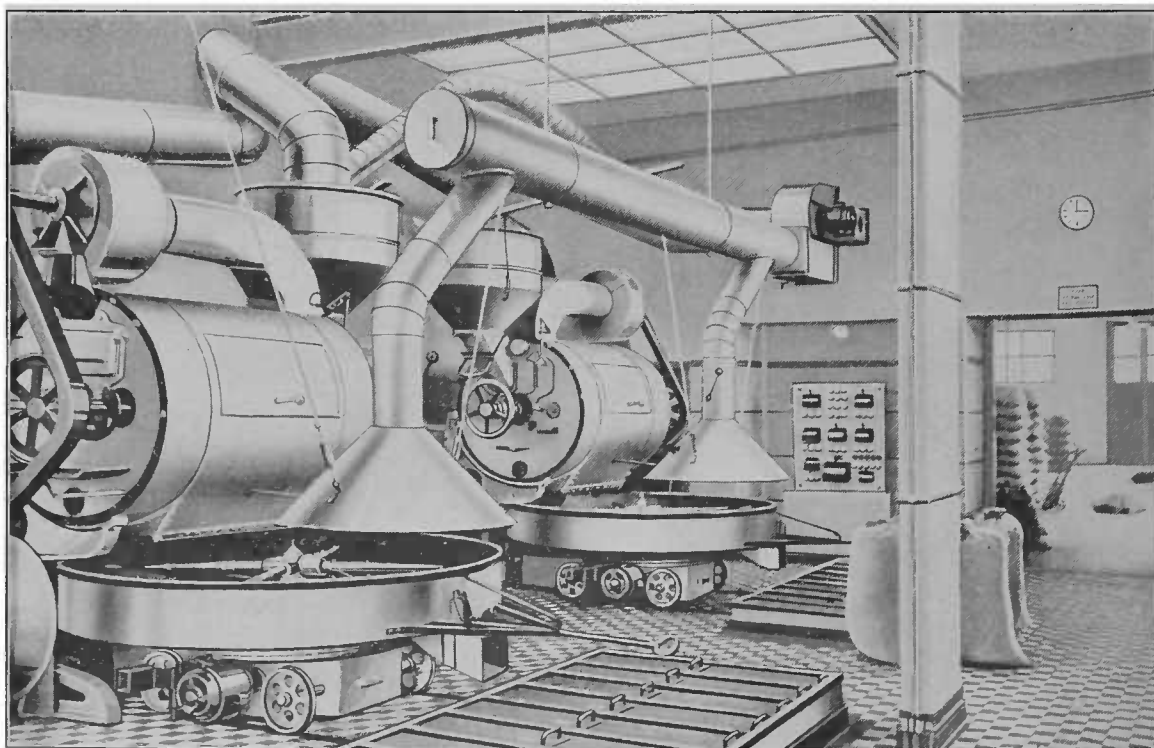
of coffee substitutes. The heating process in European roasters—differing entirely from the American plan<sup>1</sup> of a burner inside the roasting drum—has the combustion unit outside, and the hot gases circulate first around and then through the drum. This permits an easier regulation of the heat as the roast progresses. An installation of several gas-heated roasters of 60 to 90 kilogram capacity is generally preferred to one very large machine. A novel machine, having two roasting drums, is the "Corona" roaster made by Kirsch and Mausser, of

<sup>1</sup>The latest American roasters do not have burners inside the drums.

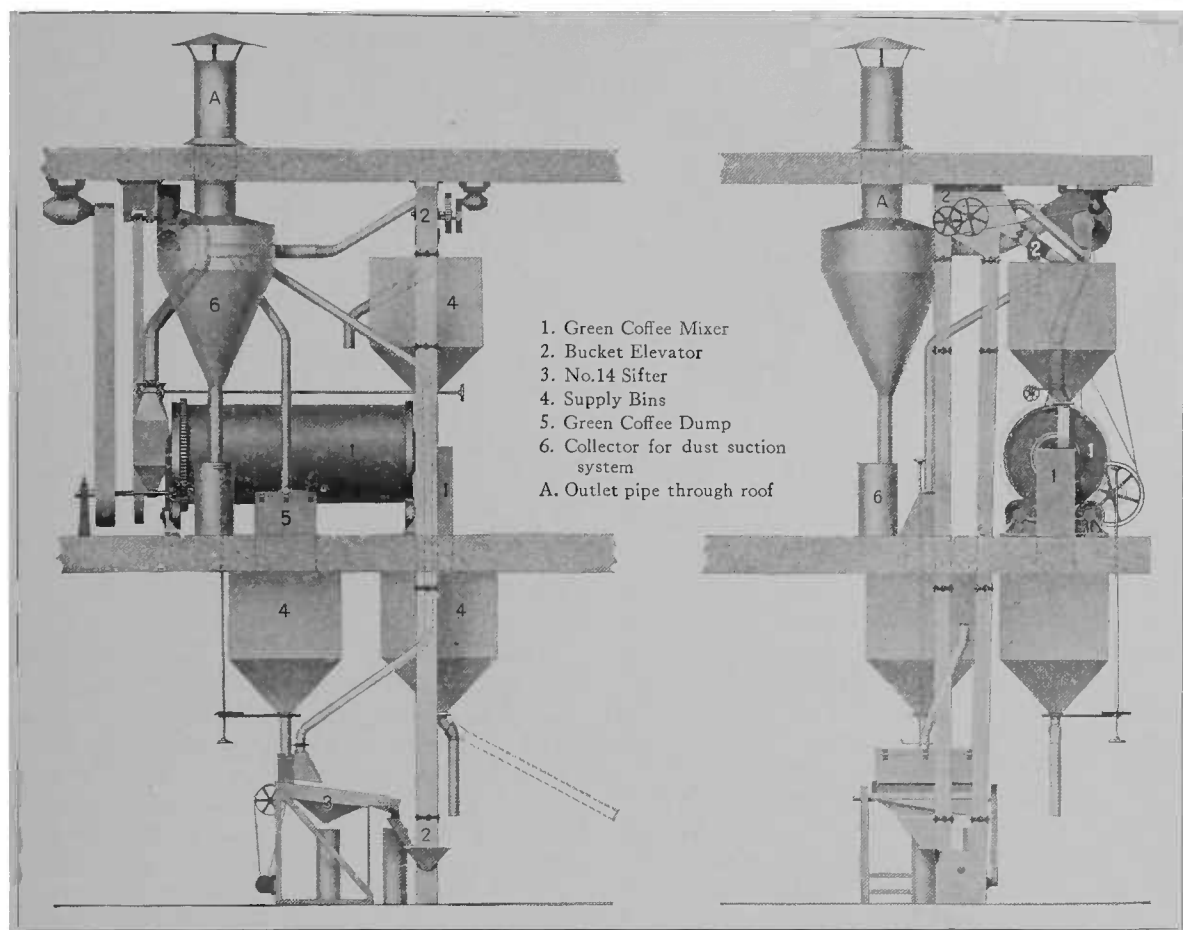
Heilbronn. The upper drum serves for heating the coffee and the lower one for finishing. The great advantage is economy in fuel.

Another well-known German firm is the Ferd. Gothot Company of Mülheim-Ruhr, highly successful manufacturers of "Ideal-Rapid" coffee machinery. They have specialized in roasters for high-speed production, as explained in a recent statement which may be summarized as follows:

About 40 years ago a campaign began for the more rapid roasting of coffee, and against all opposition and prejudice "four batches per hour" became accepted procedure, even with dealers who formerly thought coffee needed roasting for 18 minutes or more. The favorable results of rapid roasting (which really makes for better quality, as shown by repeated tests with even shorter roasting periods) have made this method of roasting very popular. With the "Ideal-Rapid" machines of the Gothot firm it has been made possible to roast a batch in 6 to 10 minutes. This fast roasting increases the percentage of aromatic substances and retains fully the fine essences of the bean. The machines have a specially designed air-blast burner and the temperature of the gas flame is as high as 1800 degrees C. (more than 2900 degrees F.); so the roasting takes place in an atmosphere of nitrogen and practically pure carbon dioxide; a medium having a neutral action on the coffee's aromatic constituents. The Gothot firm has placed these gas-heated machines in many large coffee establishments including some who roast 600 bags and more per



TWO "IDEAL-RAPID" GAS MACHINES IN AN ESTABLISHMENT IN NORTHERN GERMANY



STANDARD ARRANGEMENT OF BURNS APPARATUS FOR CLEANING AND MIXING GREEN COFFEE

day; and supplies all the other apparatus required for complete roasting plants.

Research in America has failed to confirm the idea that coffee can be more perfectly developed merely by roasting it more quickly, and for the 500-lb. or four-bag batches which are usual in the United States plants it seems proved that faster work than three roasts per hour would be a mistake. At any rate the Gothot statement, giving a roasting-time range of 6 to 15 minutes with quantity of coffee not specified, seems rather vaguely ideal; and perhaps roasters of various other models which are merely described by the ringing German word *schnell* (quick), are found quite satisfactorily swift.

#### *Cleaning and Mixing Green Coffee*

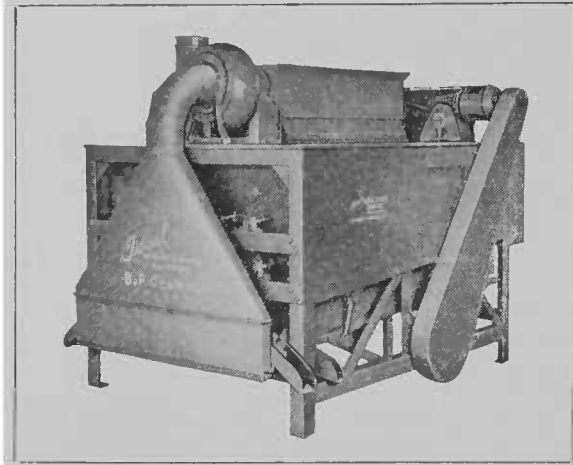
In United States plants the most successful type of mixer is a horizontal, roller-supported revolving cylinder with an internal system of helical flanges by which the contents are completely mixed in about

five minutes. Two standard sizes are made, different only in cylinder length. The hourly capacity is 36 and 48 bags respectively, the time required for filling and emptying the cylinder being considerably more than for the actual mixing.

The correct use of the machine requires three bins, each of mixer-batch capacity: one hung to the ceiling below under the green coffee dump; one above the mixer front into which a two-story bucket elevator transfers the unmixed batch; and one hung under the mixer floor-discharge chute.

The rear of the mixer has a screened suction box, pipe-connected to an overhead fan which constantly draws air, from the front, through the entire length of the cylinder and discharges outdoors through a dust collector.

This dust removal from the tumbling coffee is a valuable feature, and in most installations it supplements the work of a special sifting-and-suction cleaner which is placed in the lower story, between the mixer-supply bin and the transfer eleva-

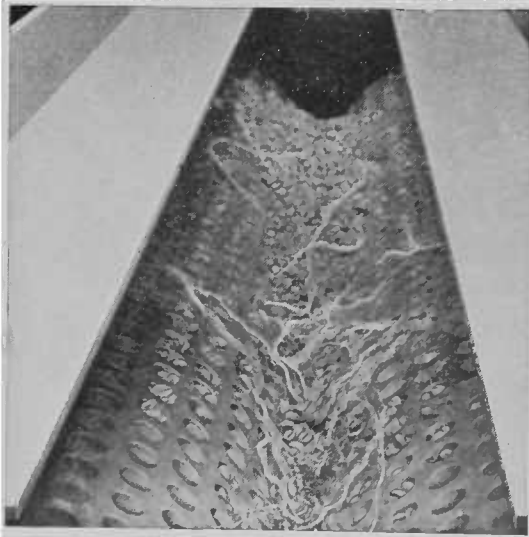


GUMP "IDEAL" GREEN COFFEE CLEANING MACHINE

tor, as shown in the two-view cut. A branch discharge from the elevator provides for sending sifted goods direct to the roaster supply bin when blending is not desired.

The floor opening, through which the bagged coffee is emptied into the bin below, is covered by a standard "green-coffee dump." This metal housing, with three vertical sides and a sloping front which forms a top-hinged door, has a gate on top for connection to the air-suction system. By this arrangement all scattering of the green coffee is avoided, and much loosened dust can be carried off by the fan and blown into the collector.

A recent model of a successful machine for cleaning green coffee, made by the B.



SECTION OF "IDEAL" COFFEE CLEANING MACHINE  
Illustrating how strings and other trash are separated from the coffee by means of an indented cylinder, which passes the beans to a vibrating screen, air suction pulling out the remaining dust, hulls, etc.

F. Gump Company of Chicago, is illustrated. Particular excellence is claimed in the removal of bits of string, which is always considered a problem of special difficulty.

#### *Roasting by Coal or Coke, Gas, Oil, and Electricity*

In the United States, roasters using coal or other solid fuel have not been built for many years; and practically all coffee is now roasted by gas. There has been some successful employment of oil which, in some cases, is first turned into gas by a suitable device; and if lower costs prevail these heat-from-oil processes may become widely used. In other countries, the adoption of gas-fuel roasters has been less complete, but only because of high gas cost in relation to coal or coke.

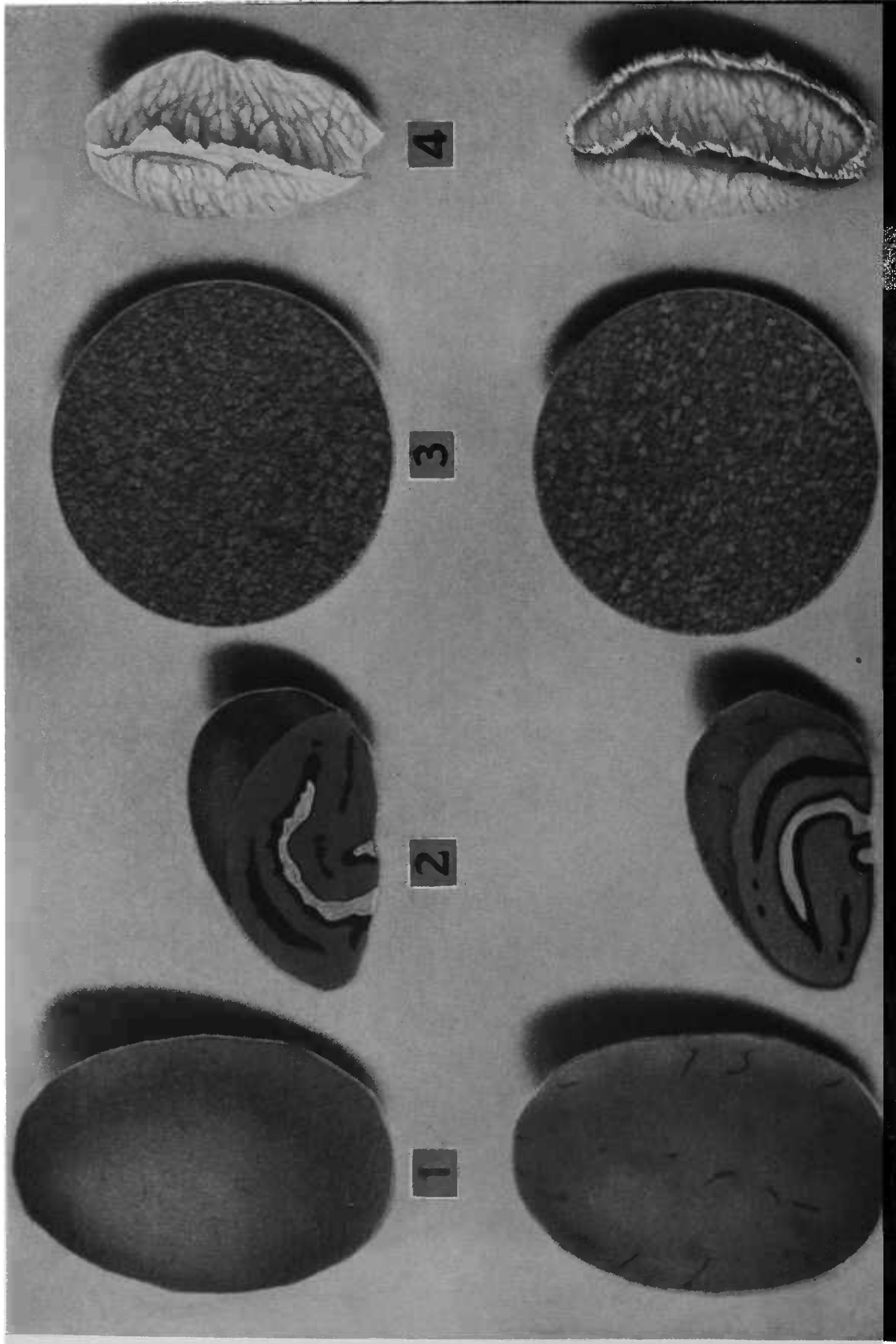
The American use of gas instead of coal was not initiated by the roaster manufacturers at all, but by users of standard coal-fired machines in districts where abundant natural gas was discovered. Its low cost caused a rapid replacement of coal and coke for house heating and various industrial operations. Many of these early adaptations were decidedly crude, but it was not difficult to take out coffee-roaster grates—under the front of the long cylinders then used—and substitute an atmospheric gas burner, connected to the roaster "blast pipe," which brought air into the ash-pit to aid solid-fuel stoking.

Pipe-line distribution of natural gas extended its use; manufactured gas was cheapened by new processes to meet competition; and makers of coal-burning apparatus began offering gas-fuel models. A roaster of two-bag capacity was produced by Jabez Burns & Sons, having a gas burner under the front of a 2x7-ft. cylinder, forming a completely assembled machine with asbestos-insulation jacketing.

Then came roasters with short cylinders of relatively large diameter and with the gas burner inside, following the "direct flame" methods originated by Topholme of England and Henneman of Holland.

An early United States model was built by the Potter Parlin Company of New York, and was developed later with much success by the Huntley Manufacturing Co. of Brocton, N. Y., as the "Monitor" roaster. Larger sizes were developed later as the demand for small machines became

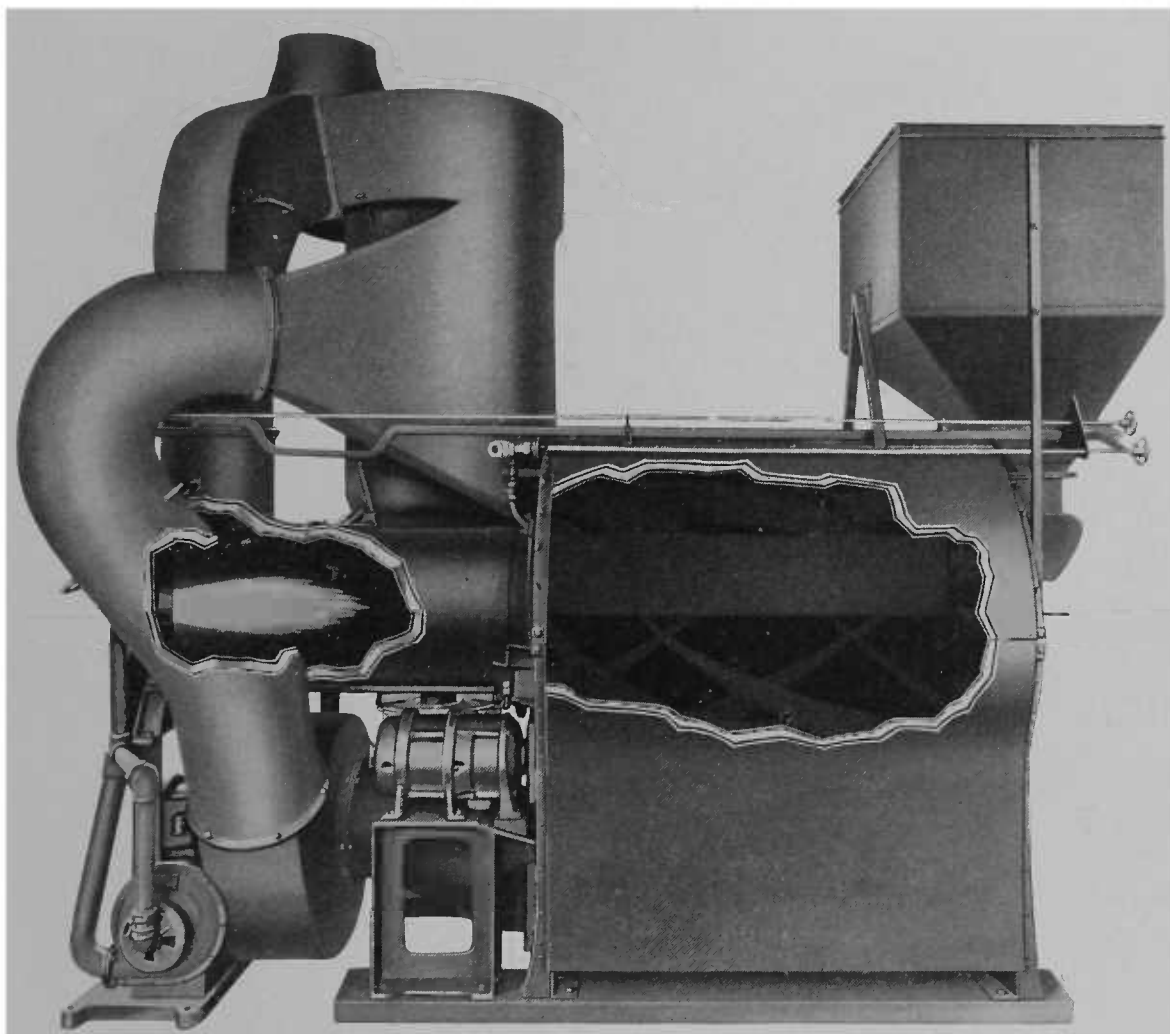




**PHOTO-ENLARGEMENT OF COFFEE ROASTED BY TWO COMMERCIAL METHODS OF HEAT TREATMENT**

*Upper row; effect of rapid roasting at low-temperature by recirculating method: Lower; effect of roasting to same surface color by high-temperature. Notes: 1. difference in surface appearance; 2. color inside the bean; 3. color when ground; and 4. charring effect of high-temperature.*





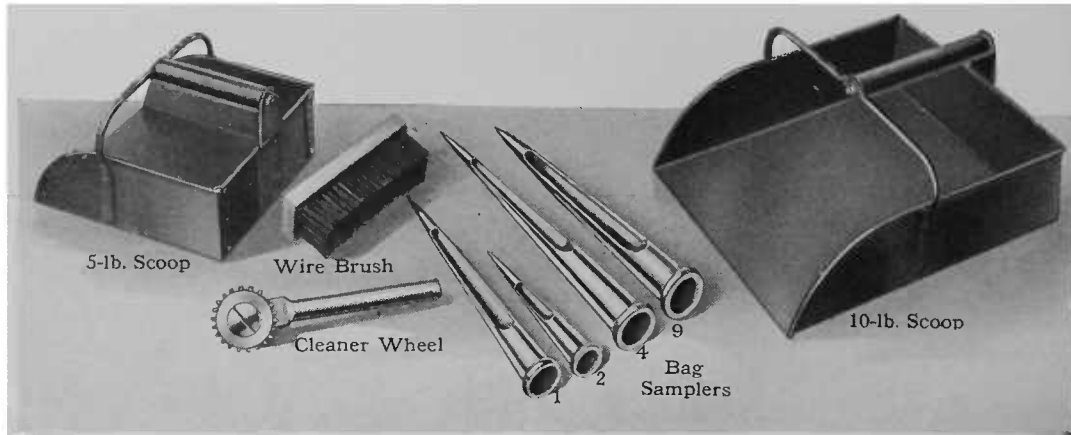
SIDE VIEW OF "THERMAL" GAS COFFEE-ROASTING MACHINE  
Showing the position of the combustion chamber in relation to the roasting cylinder.

less, and a four-bag "Monitor" is now offered, quite similar to the Burns direct-flame roaster of 1900 which preceded the "Jubilee" with its hooded interior burner. This development of more convenient coffee roasters, using gas fuel only, gradually led to the complete displacement of coal-burning models.

Electric heat has not been used with any success. But as long as consumers and some coffee men feel sure that "electric-roasted coffee" *ought* to indicate a better beverage, there will no doubt be many more attempts to develop the needed process. Various trials have been made in the United States, with some claims of success; but facts disclosed by other tests indicate that electric heat, irrespective of cost, would be definitely inferior to gas for the roasting of coffee.

A radical departure in apparatus for

the commercial production of roasted coffee was introduced in 1934 by Jabez Burns & Sons, Inc., announcing a patented low-temperature process for which the name "Thermal" has been officially registered. They explain that through systematic investigation, carried on for years in their research department, it was found that by reducing the roasting temperature, without prolonging the time for applying the needed quantity of heat, greatly improved results were obtained, both in appearance and cup quality. Uniformity, always a sign of a good roast, was not only perfectly effected throughout the batch but it became a characteristic of each individual bean. And it was demonstrated by repeated cup tests that these beans, uniform in color from center to surface and all over the surface, produced an infusion which showed a more complete development of



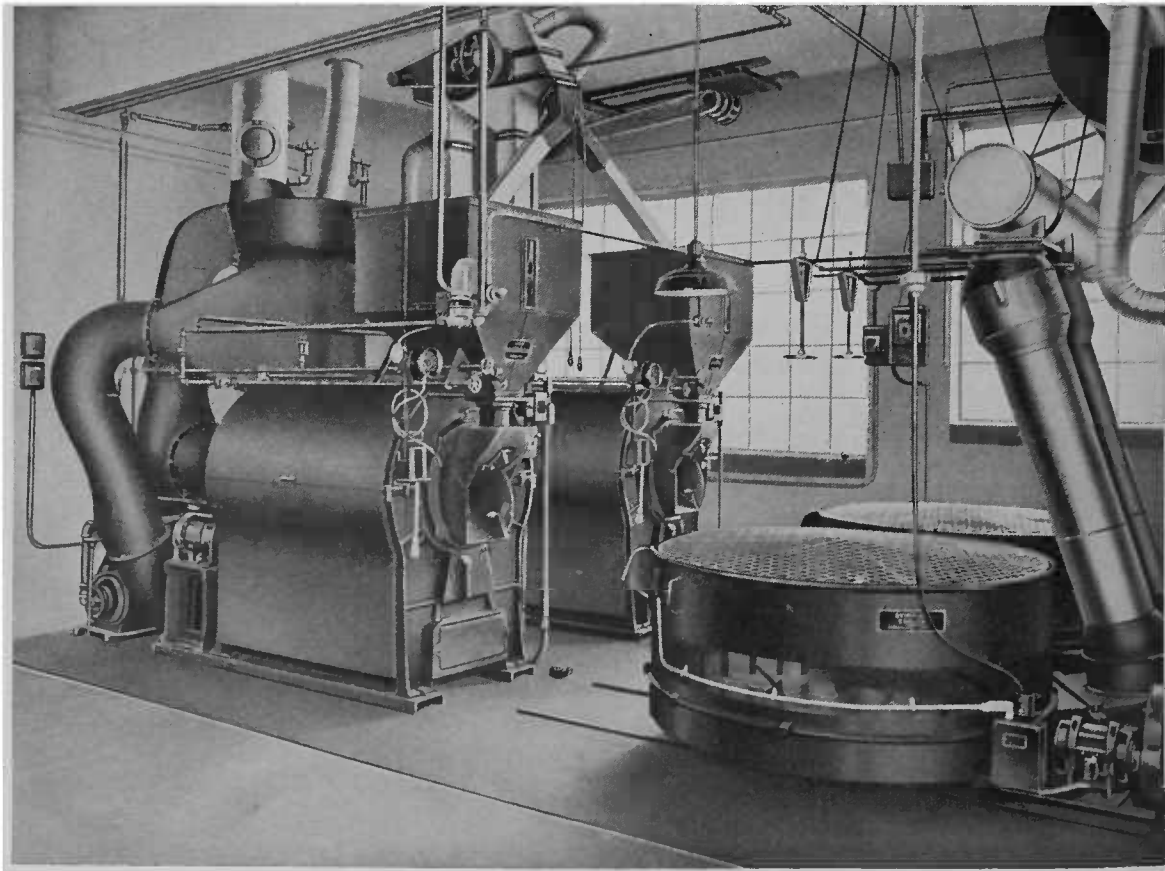
A GROUP OF ROASTING-ROOM ACCESSORIES

certain qualities of flavor, body, and aroma characteristic of the kind of ground coffee being tested.

The production of a factory-size machine employing the new process was accomplished in due course, and after operation for many months on full commercial

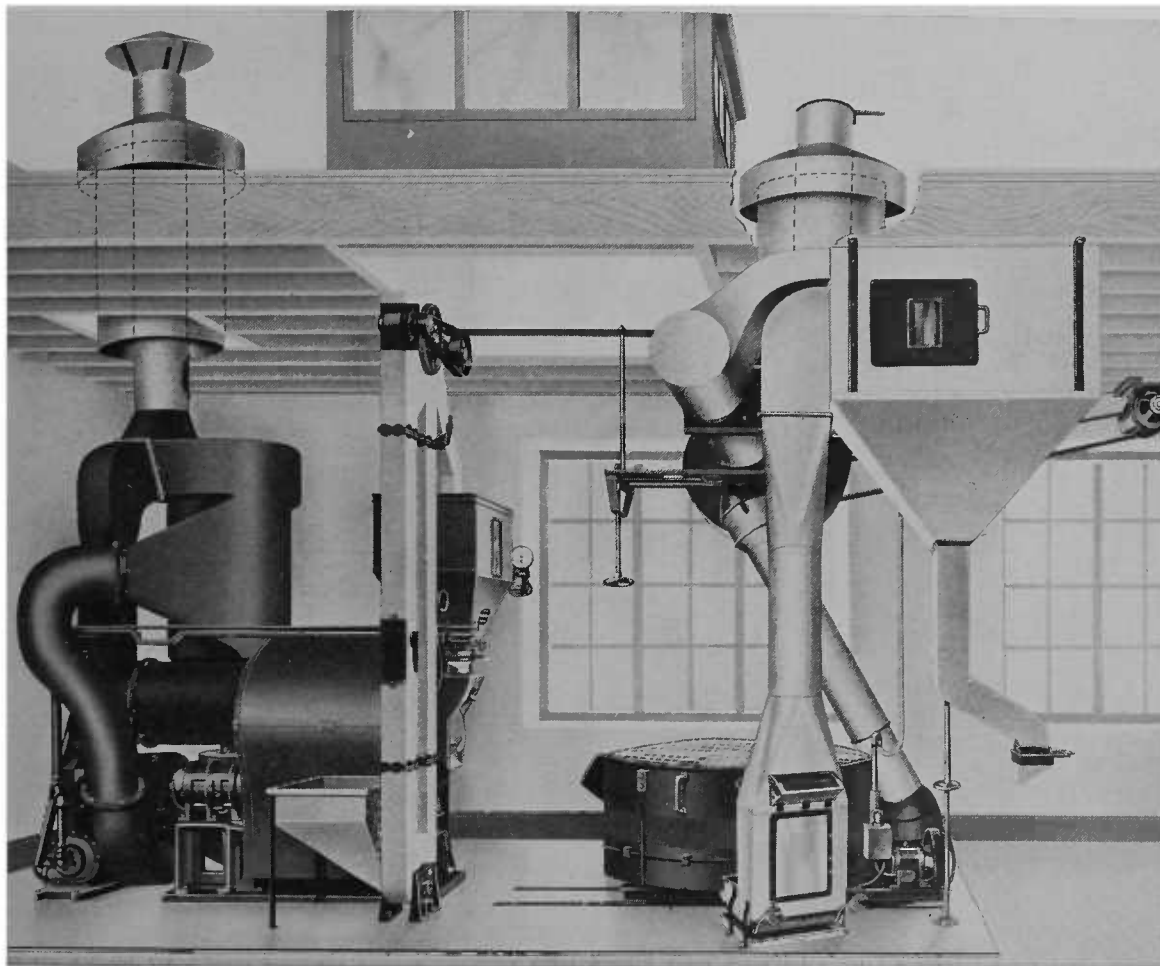
batches the final designs were adopted and put in production.

The first machine was bought by an old-established New York firm, acquainted with all roasters since "pull-out" cylinder days; and its performance caused the prompt replacement of all the roasters in



AN INSTALLATION OF LATEST TYPE AMERICAN COFFEE-ROASTING EQUIPMENT

View in the plant of Fisher Bros. Company, Cleveland, which includes two "Thermalo" machines and new cooling and stoning apparatus (at right).



A TYPICAL ONE-STORY COFFEE-ROASTING PLANT

"Thermalo" roaster at left, with "Stirflex" cooling and stoning equipment at right.

the plant (ten "Jubilee-Premix" machines) with new "Thermalo" apparatus of the same capacity. "Thermalo" installations are now in successful operation in all parts of the country.

A typical two-roaster setting of "Thermalo" machines in the new plant of the Grand Union Tea Company of Chicago, is shown on page 234; and a general idea of the "Thermalo" process may be obtained from the side-view cut (p. 243), which reveals some of the interior. The front of the roaster, and the cylinder, are much the same as in "Jubilee-Premix" machines. The rear parts—entirely different and extending further back—include the chief elements of the system for generating and circulating heat.

The heat is produced by any suitable means, but preferably by a gas flame, confined to the rear part of a long combustion chamber; the burner nozzle receiving gas

and air from the "Premix" fan set below. Three motors provide independent drives: for the cylinder, for the burner fan, and for the heat-stream fan which creates the circulation on which the whole process depends. This fan draws from the space around the cylinder all the combustion gases, etc., which pass through the cylinder perforations, and sends this heat stream continually through a specially-compact collector, which removes the chaff, and back to the combustion chamber, to be constantly recirculated.

The temperature of the cylinder is regulated by controlling the velocity of the circulating heat stream; and excess gases, evolved by the coffee and the flame, are allowed to pass outdoors instead of returning to the combustion chamber. The temperature to which the coffee is exposed is less than one-half as much as in ordinary methods but the time of roasting is not in-

A GREEN COFFEE SHRINKAGE TABLE

Showing shrinkage in roasting of raw coffee in quantities from sixty pounds up to three hundred pounds, and at six different shrinkage percentages  
 Compiled by R. C. Wilhelm, New York

RAW	12%	13%	14%	15%	16%	17%	RAW	12%	13%	14%	15%	16%	17%	RAW	12%	13%	14%	15%	16%	17%
60	52%	52%	51%	51	50%	49%	140	123%	121%	120%	119	117%	116%	220	193%	191%	189%	187	184%	182%
61	53%	53	52%	51%	51%	50%	141	124	122%	121%	119%	118%	117	221	194%	192%	190	187%	185%	183%
62	54%	54	53%	52%	52	51%	142	125	123%	122	120%	119%	117%	222	195%	193%	191	188%	186%	184%
63	55%	55%	54	53%	53	52%	143	125%	124%	123	121%	120	118%	223	196%	194	191%	189%	187%	185
64	56%	56%	55	54%	54	53	144	126%	125%	124%	122%	121	119%	224	197	195	192%	190%	188%	186
65	57%	57%	56	55%	54%	54	145	127%	126%	125%	123%	121%	120%	225	198	196%	193%	191%	189	187%
66	58	57%	56%	55%	55%	54%	146	128%	127	126%	124	122%	121%	226	199	196%	194%	192	189%	187%
67	59	58%	57%	57	56%	55%	147	129%	128	126%	125	123%	122	227	199%	197%	195%	193	190%	188%
68	59%	59%	58%	57%	57	56%	148	130%	128%	127%	125%	124%	122%	228	200%	198%	196	193%	191%	188%
69	60%	60	59%	58%	58	57%	149	131	129%	128%	126%	125%	123%	229	201%	199%	197	194%	192%	189
70	61%	61	60%	59%	58	58	150	132	130%	129	127%	126	124%	230	202%	200	198	195%	193%	189
71	62%	62	61	60%	59%	59	151	133	131%	129%	128%	126%	125%	231	203%	201	198%	196%	194%	192
72	63%	62%	62	61	60%	59%	152	133%	132%	130%	129%	127%	126%	232	204	202	199%	197	195	192%
73	64%	63%	62%	62	61%	60%	153	134%	133	131%	130	128%	127	233	205	202%	200%	198	195%	193%
74	65	64%	63%	63	62%	61%	154	135%	134	132%	131	129%	127%	234	206	203%	201	199	196%	194
75	66	65%	64%	63%	63	62%	155	136%	134%	133%	131%	130%	128%	235	206%	204%	202	199%	197%	195
76	67	66%	65%	64%	63%	63	156	137%	135%	134%	132%	131	129%	236	207%	205	203	200%	198	196
77	67%	67	66%	65%	64%	64	157	138%	136%	135	133%	132	130%	237	208%	206%	203%	201%	199	197%
78	68%	68	67	66%	65%	64%	158	139	137%	136	134%	133%	131%	238	209%	207	204%	202%	200	197%
79	69%	68%	68	67%	66%	65%	159	140	138%	136%	135%	133%	132	239	210%	208	205%	203%	200%	196%
80	70%	69%	68%	68	67%	66%	160	140%	139%	137%	136	134%	132%	240	211	208%	206%	204	201%	199
81	71%	70%	69%	69	68	67%	161	141%	140	138%	136%	135%	133%	241	212	209%	207%	204%	202%	200
82	72%	71%	70%	69%	69	68	162	142%	141	139%	137%	136	134%	242	213	210%	208	205%	203	201
83	73	72%	71%	70%	69%	69	163	143%	141%	140%	138%	137	135%	243	213%	211%	209	206%	204	201%
84	74	73%	72%	71%	70%	69%	164	144%	142%	141	139%	137%	136	244	214%	212%	210	207%	205	202%
85	74%	74	73%	72%	71%	70%	165	145%	143%	142	140%	138%	137	245	215%	213	210%	208%	205%	203%
86	75%	74%	74	73%	72%	71%	166	146	144%	142%	141	139%	137%	246	216%	214	211%	209	206%	204
87	76%	75%	75	74	73%	72%	167	147	145%	143%	142	140%	138%	247	217%	215	212%	210	207%	205
88	77%	76%	76%	74%	73%	73	168	147%	146%	144%	142%	141	139%	248	218	216	213	211	208	206
89	78%	77%	78%	75%	74%	74	169	148%	147	145%	143%	142	140%	249	219	216%	214%	211%	209%	207
90	79%	78%	77%	76%	75%	75	170	149%	148	146%	144%	142%	141	250	220	217%	215	212%	210	207%
91	80%	78%	77%	76%	75%	75	171	150%	148%	147	145%	143%	142	251	221	218%	215%	213%	210%	208%
92	81	80	79%	78%	77%	78%	172	151%	149%	148	146%	144%	142%	252	222	219	216%	214	212	208
93	82	81	80	79	78	77%	173	152%	150%	148%	147	145%	143%	253	222%	220	217%	215	212%	210
94	82%	81%	80%	79	78	78	174	153	151%	149%	148	146%	144%	254	223%	221	218%	216	213%	211
95	83%	82%	81%	80%	79	79	175	154	152%	150%	148%	147	145%	255	224%	222	219%	218%	214%	211%
96	84%	83%	82%	81%	80%	79%	176	155	153	151%	149%	147%	146	256	225	223	220	218	215	212
97	85%	84%	83%	82%	81%	80%	177	155%	154	152%	150%	148%	147	257	226	223%	221	218%	218	213
98	86%	85%	84%	83%	82%	81%	178	156%	154%	153	151%	149%	147%	258	227	224%	222	219%	216%	214
99	87%	86%	85%	84%	83%	82%	179	157%	155%	154	152%	150%	148%	259	228	225%	222%	220%	217%	215
100	88	87	86	85	84	83	180	158%	156%	154%	153	151%	149%	260	229	226	224	221	218	216
101	89	87%	86%	85%	84%	83%	181	159%	157%	155%	153%	152	150%	261	229%	227	225	222	219	218%
102	89%	88%	87%	86%	85%	84%	182	160%	158%	156%	154%	153	151	262	230%	228	225	222%	220	217%
103	90%	89%	88%	87%	86%	85%	183	161	159%	157%	155%	153%	152	263	231%	229	226%	223%	221	218%
104	91%	90%	89%	88%	87%	86%	184	162	160%	158%	156%	154%	152%	264	232	230	227	224	222	219
105	92%	91%	90%	89%	88%	87%	185	162%	161	159	157%	155%	153%	265	233	230%	228	225	222%	220
106	93%	92%	91%	90%	89%	88	186	163%	161%	160	158	156%	154%	266	234	231%	228%	226	223%	220%
107	94	93%	92	91	90	89%	187	164%	162%	160%	159	157	155%	267	235	232%	229%	227	224%	221%
108	95	94	93	91%	90%	89%	188	165%	163%	161%	160	158	156	268	236	233	230%	228	225	222
109	96	95	94%	92%	91%	90%	189	166%	164%	162%	160%	158%	156%	269	238%	234	231%	228%	226	223%
110	97%	96%	95%	93%	92%	91%	190	167%	165%	163%	161%	159%	157%	270	237%	235	232	229%	226%	224
111	97%	96%	95%	94%	93%	92%	191	168	166%	164%	162%	160%	158%	271	238%	235%	233	230%	227%	225
112	98%	97%	96%	95%	94%	93	192	169	167	165	163%	161%	159%	272	239	237	234	231	228	226
113	98%	98%	97%	96	95	93%	193	169%	168	166	164	162	160%	273	240	237%	234%	232	229	226%
114	99%	98%	98	97	95%	94%	194	170%	168%	166%	165	163	161	274	241	238%	235%	233	230	227%
115	101%	100%	99	97%	96%	95%	195	171%	169%	167%	165%	163%	161%	275	242	239%	236%	233%	231	228%
116	102	101	99%	98%	97%	96%	196	172%	170%	168%	166%	164%	162%	276	243	240	237%	234%	232	229
117	103	101%	100%	99%	98%	97	197	173%	171%	169%	167%	165%	163%	277	243%	241	238%	235%	232%	230
118	103%	102%	101%	100%	99	98	198	174%	172%	170%	168%	166%	164%	278	244%	242	238	236%	233%	230%
119	104%	103%	102%	101	100	98%	199	175	173%	171%	169%	167%	165%	279	245%	243	240	237	234%	231%
120	105%	104%	103	102	101	99%	200	176	174	172	170	168	166	280	246%	243%	241	238	235%	232%
121	106%	105%	104	102%	101	100%	201	177	174%	173	171%	168%	166%	281	247%	244%	241%	238%	236	233%
122	107%	106	105	103%	102%	101%	202	177%	175%	173%	171%	169%	167%	282	248	245%	242%	239%	237	234
123	108%	107	105%	104%	103	102	203	178%	176%	174%	172%	170%	168%	283	249	246%	243%	240%	237%	235
124	109	108	106%	105%	104	103	204	179%	177%	175%	173%	171%	169%	284	250	247	244	241%	238%	235%
125	110	108%	107%	106%	105	103%	205	180%	178%	176%	174%	172%	170%	285	250%	248	245	242%	239%	236%
126	111	109%	108	107	106	104%	206	181%	179%	177%	175	173	171	286	251%	249	246	243	240	237%
127	111%	110%	109%	108	106%	105%	207	182%	180	178	176	174	171%	287	252%	249%	246%	244	241	238%
128	112%	111%	110	109	107%	106	208	183	181	179	177%	174%	172%	288	253%	250%	247%	245	242	239
129	113%	112%	111	109%	108%	107	209	184	181%	179%	177%	175%	173%	289	254%	251%	248%	245%	242%	238%
130	114%	113	112	110%	109	108	210	184%	182%	180%	178%	176%	174%	290	255	252%	249%	246%	243%	240%
131	115%	114	112%	111%	110	108%	211	185%	18											

creased, because the doubled velocity of the circulating gases brings an equal number of heat units per minute to the coffee.

The "Thermal" roaster uses the same discharge system as the "Jubilee-Premix" model which it supersedes; so it works perfectly with the standard "Stirflex" cooling and stoning apparatus made by the Burns firm since 1929, and covered by patents granted in 1932. The first circular cooler trays with mechanical stirrers were produced in Europe; but the Burns construction gives an improved mixing action, and the stirrers are so shaped that streams of unheated air pass down behind them into the lower layers of the coffee, giving simultaneous cooling at all levels. This is continued till the coffee temperature is below the point at which uneven color development is possible.

The "stoning" operation is the final step in producing roasted coffee such as is completely ready for safe grinding. This gravity separation of heavier foreign material through controlled air suction has been given new accuracy by the improved "stoner boot" design of today. This creates two separate and different air pressures, one barely sufficient to lift the coffee, the other—above the separating zone—sufficient for a swift elevation of the stoneless product.

*Roasting Efficiently*

A. L. Burns of New York, who is well qualified to write on this subject, says:

In many industrial processes today the machine itself has become so reliably efficient that the operator merely needs to equal it in unfailingly correct routine. But unfailing correctness is a rare human quality; and the persons who superintend the best coffee-roasting machinery of today should be carefully chosen and treated with due consideration. Although much of the old manual skill is no longer required, the same sort of alertness and good judgment is essential. Touching a control valve is child's work; but seeing just when to make adjustments and to what degree is a real job.

Most of the writer's remarks on the subject of roasting efficiency which appeared in the first edition of this book are out of date now, but the final paragraphs about watering the roast still seem of value and they may be condensed thus:

When coffee is roasted correctly it must sustain a definite loss in weight, mostly by water evaporation, which there is no logical way to avoid. This proper shrinkage averages about 16 per cent, and varies with the kind of coffee and its age. Adding some water at the end of the operation checks the roast advantageously,

COST CARD FOR ROASTERS

BY PAYSON MACKEYE

Showing the Value Added to Green Coffee by Roasting

BASIS: Sixteen per cent shrinkage. Three-quarters of a cent a pound for roasting.

Green	Roasted	Green	Roasted	Green	Roasted
7¢	9.23	18¢	22.32	29¢	35.42
1/4	9.52	1/4	22.62	1/4	35.71
1/2	9.82	1/2	22.92	1/2	36.01
3/4	10.12	3/4	23.21	3/4	36.31
8¢	10.42	19¢	23.51	30¢	36.61
1/4	10.71	1/4	23.81	1/4	36.90
1/2	11.01	1/2	24.11	1/2	37.20
3/4	11.31	3/4	24.40	3/4	37.50
9¢	11.61	20¢	24.70	31¢	37.80
1/4	11.90	1/4	25.00	1/4	38.10
1/2	12.20	1/2	25.30	1/2	38.39
3/4	12.50	3/4	25.60	3/4	38.69
10¢	12.80	21¢	25.89	32¢	38.99
1/4	13.10	1/4	26.19	1/4	39.29
1/2	13.39	1/2	26.49	1/2	39.58
3/4	13.69	3/4	26.79	3/4	39.88
11¢	13.99	22¢	27.08	33¢	40.18
1/4	14.29	1/4	27.38	1/4	40.48
1/2	14.58	1/2	27.68	1/2	40.77
3/4	14.88	3/4	27.98	3/4	41.07
12¢	15.18	23¢	28.27	34¢	41.37
1/4	15.48	1/4	28.57	1/4	41.67
1/2	15.77	1/2	28.87	1/2	41.96
3/4	16.07	3/4	29.17	3/4	42.26
13¢	16.37	24¢	29.46	35¢	42.56
1/4	16.67	1/4	29.76	1/4	42.86
1/2	16.96	1/2	30.06	1/2	43.15
3/4	17.26	3/4	30.36	3/4	43.45
14¢	17.56	25¢	30.65	36¢	43.75
1/4	17.86	1/4	30.95	1/4	44.05
1/2	18.15	1/2	31.25	1/2	44.35
3/4	18.45	3/4	31.55	3/4	44.64
15¢	18.75	26¢	31.85	37¢	44.94
1/4	19.05	1/4	32.14	1/4	45.24
1/2	19.35	1/2	32.44	1/2	45.54
3/4	19.64	3/4	32.74	3/4	45.83
16¢	19.94	27¢	33.04	38¢	46.13
1/4	20.24	1/4	33.33	1/4	46.43
1/2	20.54	1/2	33.63	1/2	46.73
3/4	20.83	3/4	33.93	3/4	47.02
17¢	21.13	28¢	34.23	39¢	47.32
1/4	21.43	1/4	34.52	1/4	47.62
1/2	21.73	1/2	34.82	1/2	47.92
3/4	22.02	3/4	35.12	3/4	48.21

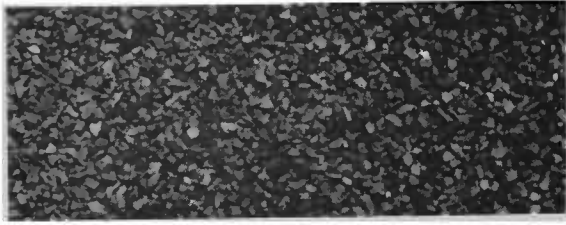
Roasting "cost" means a charge (per pound green) which the trade considers reasonable for roasting coffee as an independent business. A roasting cost 1/2 cent higher can be allowed for by using the roasted value in the next line below in the table. Shrinkage is figured by dividing the weight of the roasted batch by its original weight green.

but this usual practice should never be abused by soaking the coffee to reduce shrinkage. For, if not done dishonestly—to steal coffee belonging to someone else—it is still done unwisely, for the water-weighted coffee has a diluted cup value that more than counterbalances all apparent gain.

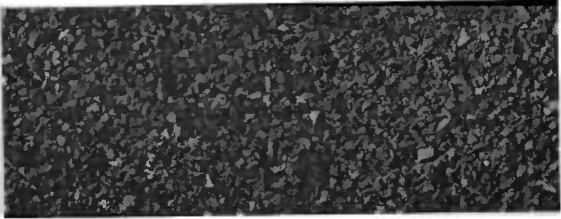
Efficiency should, of course, be stressed in every needed operation in coffee preparation from the far-away plantation to the near-by roastery; and no one can say authoritatively that certain critical stages in the treatment of the coffee-tree fruit may not affect final cup value just as much as the later magic of the roasting operation.

The present condition of the coffee trade in general is none too good. Over-production is increasing and prices tend downward. The one

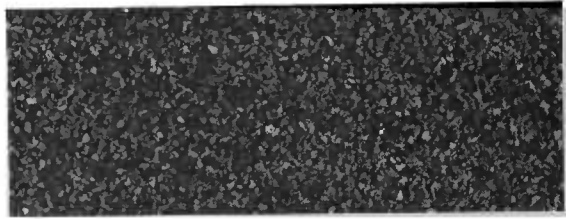




Percolator Grind



All-Purpose Grind



Drip Grind

#### VISUALIZING ROASTED COFFEE GRINDS

The illustrations show the exact size of the granulations in the percolator, and drip grinds as compared with the universal or all-purpose grind. The latter represents a comparatively recent development in U. S. A. coffee grinding practice.

remedy is a larger world-wide consumption; and that can only result from offering consumers roasted coffee which is more perfectly prepared and which they are taught to rate by "goodness in the cup" and not by "cups to the pound." Consumption is discouraged by the uncountable cups of poor coffee which are served daily, mostly the result of faulty infusion and, in particular, the use of too little coffee. Perhaps the demand for coffee could be doubled if the average cup became "twice as good." How can boarding-house keepers, for instance, hard pressed financially, be induced to double the usual weekly coffee purchase so as to serve a really satisfying breakfast beverage? But, why not, if better coffee and plenty of it should result in more clients and better ones?

So it seems of great importance, both in the roasting of coffee and the brewing operations, that a new and wide-spread efficiency should be attained, based on the latest scientific knowledge. But this implies a completeness of co-operation throughout the trade and a broad-minded honesty in coffee-industry research which are hardly characteristic of present-day activities.

One bit of honest research information deserves mention here. A talented chemist, whose recent investigations have disclosed new truths

about coffee roasting, was asked where coffee in an opened container should be kept to retard deterioration. His prompt answer was, "Wherever the temperature is lowest and preferably, the most constant, as every change pumps air in and out of a container not hermetically sealed." So the useful answer for all housewives is "in the refrigerator."

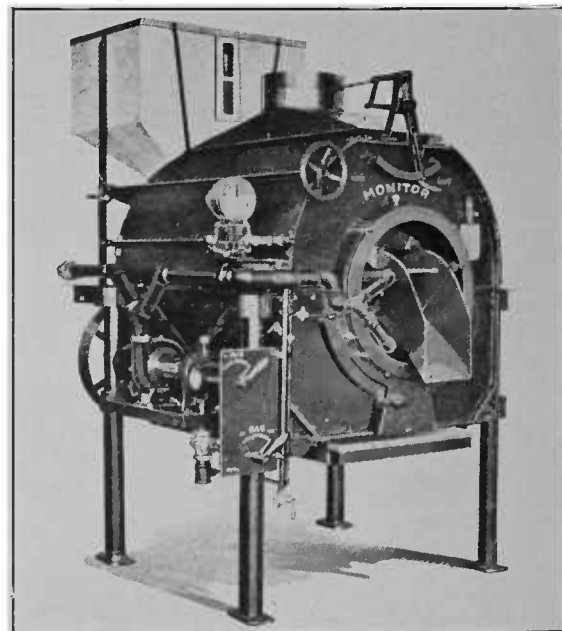
#### Modern Wholesale Grinding

The grinding of coffee on a large scale has steadily increased in recent years and many large roasting establishments now sell practically no whole-bean coffee. So the determination of a correct grain-size standard for ground coffee, and of reliable methods for achieving such a grind, have become matters of no less importance than the production of perfect roasts.

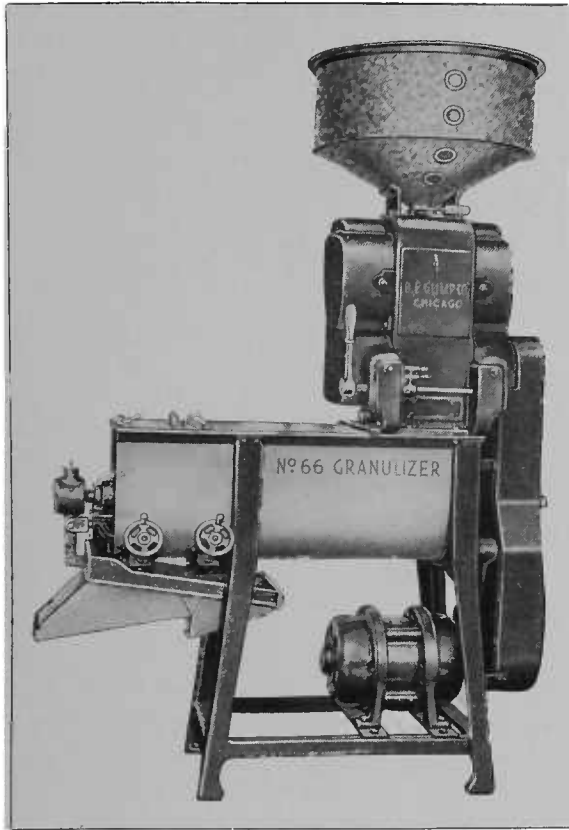
After a long series of carefully controlled infusion tests there has been discovered a universal or all-purpose grind, meaning a ground coffee which gives equally satisfactory results with any of the common brewing methods.

The "laboratory" formula for this grind prescribes a maximum granule size; and specifies the proportionate quantities of all smaller granules as measured by standard round-hole test sieves.

The design of new granulating machines, capable of rapidly producing such grinds, was the next problem; and its successful solution has been an important factor in the wholesale grinding operation of today.



"MONITOR" GAS ROASTER



GUMP COFFEE-GRINDING MACHINE

Equipment designed to produce a universal granulation suitable for use in any coffee-making device, in accordance with the latest American practice. This model has a capacity of 500 to 1,000 pounds per hour, depending on the size of the grind.

Formerly, the maximum granule size was limited by sifting the ground product and regrinding the over-size pieces. This was objectionable because the freshly ground coffee was aerated by sifting and the regrinding of a considerable portion of the product produced an excess of powder coffee. Further undesirable aeration—and some shrinkage in weight—was caused by the suction methods employed for removing chaff. These problems have been solved, in the latest factory granulators, by a gradual reduction of the bean to finished size, using a multiple arrangement of steel rolls, and by an entirely new method of reducing the chaff to powder without separating it from the ground coffee.

This method of gradual reduction and chaff treatment permits the grinding operation to be carried on in an enclosed machine. Hence the carbon-dioxide gas, given off by the coffee itself, protects the flavor oils from oxidation.

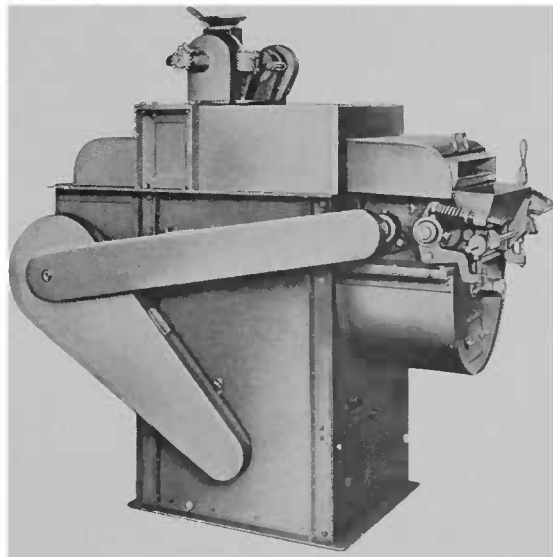
The whole coffee beans are first cracked or cut roughly into quarters on the upper

or coarse reduction rolls, then are further reduced on the second reduction, having finer corrugations and finally on the granulating rolls containing still finer corrugations and which determine the finished size of the grind.

During this gradual reduction, the chaff within the coffee beans is liberated but is not reduced to the same extent as the coffee and so requires a different treatment. Briefly, this consists in agitating the coffee with the chaff at such a speed as to reduce the chaff and distribute it uniformly through the product. The finished mass is mixed, before it is discharged, so that every pound is the same as every other.

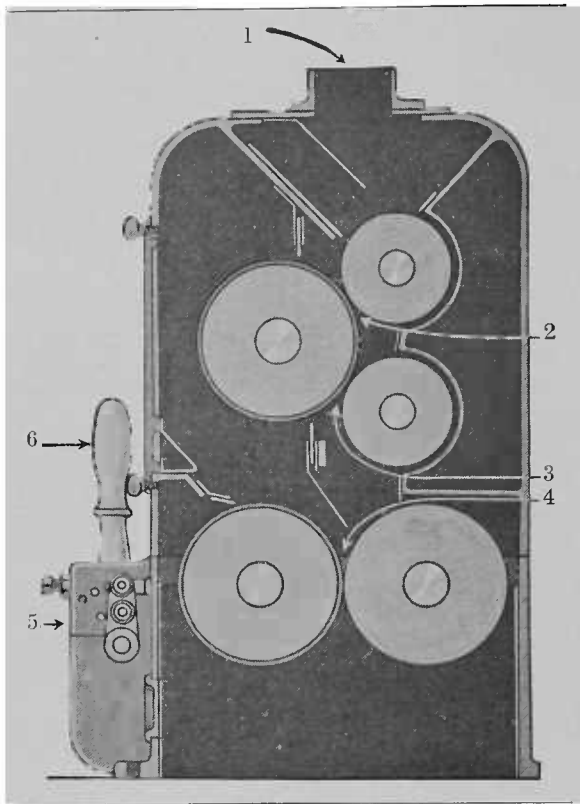
#### *Bins for Ground Coffee*

Factory grinders must discharge into a bin from which the goods can be drawn out as required for hand or machine packing. A bin of ordinary construction cannot be used satisfactorily for ground coffee, because the component granules of different sizes are sure to separate as they flow through the bin's lower part, or hopper. One manufacturer has invented what is known as the "True-flow" bin, which is considered the best solution for this problem. The illustration on page 254 shows such a bin of full-story height, to be fed from the floor above and to discharge to a packing room below. The bin's horizontal cross section is of oblong shape; and it is only the two long sides which are sloped,



BURNS COFFEE-GRINDING EQUIPMENT

Another machine for turning out an all-purpose granulation. The capacity of this machine is 500 to 1,000 pounds per hour.



SECTIONAL VIEW OF CUTTING ROLLS IN ONE TYPE OF GRINDING MACHINE

Showing the reduction rolls in an American-made machine. (1) Bean coffee inlet. (2) First reduction rolls. (3) Second reduction. (4) Third reduction. (5) Grind-adjustment setting. (6) Grind-adjustment lever.

very steeply and ending in a rounded trough which has right-and-left conveyor mechanism which carries the goods to a central discharge gate. A tapping device which, by rod connections inside, affects all sides of the bin, prevents adhesion of "flour" coffee and finely-divided chaff.

#### *The Blending of Coffee*

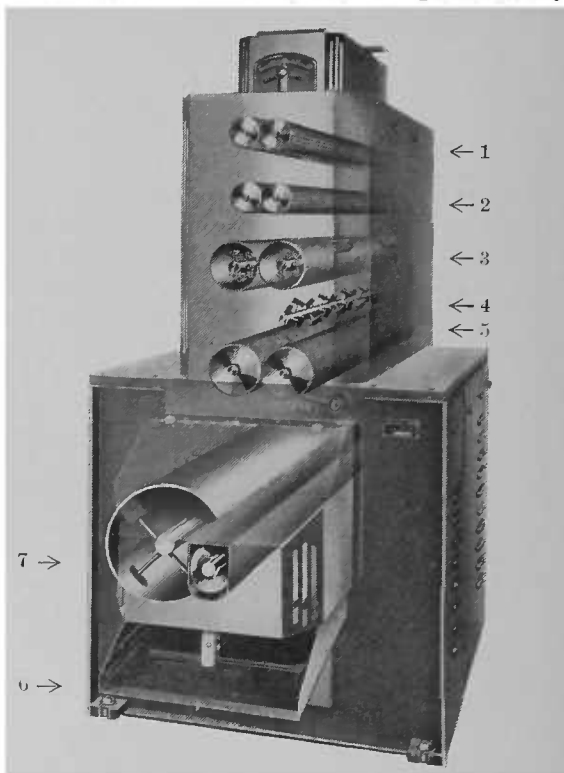
In some plants the next step is to mix the different varieties after cooling and stoning, but generally this comes before roasting. There is an increasing tendency to sell certain growths, Santos coffee for example, unblended; but the more common practice in all countries is to mix different varieties having opposing characteristics. This is called blending, a process that has attained the standing of an art in the United States. Most package coffees are blends. In addition to other qualities, the practical coffee blender must have a natural aptitude for the work. He must also have long experience before he becomes pro-

ficient, and must be acquainted with the different properties of all coffees, or at least of those that come to his market. Furthermore, he must know the variations in characteristics of current crops; for in most coffees no two crops are equal in trade values. Innumerable blends are possible.

A blend may consist of two or more kinds of coffee, but the usual practice is to employ several kinds; so that, if at any time one can not be obtained, substitution will not be so noticeable as would be the case if only two or three kinds were used.

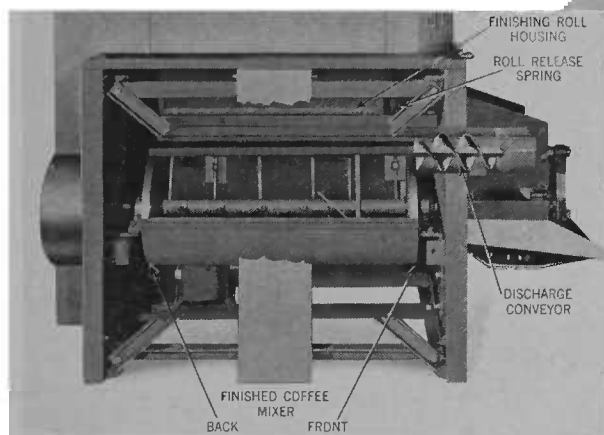
In blending coffees, consideration is given first to the shades of flavor in the cup and next to price. Generally speaking, good coffee should have strength, flavor, aroma, and acidity in fine proportion. Since individual coffees seldom give this balance, it is necessary to resort to blending.

The positive and negative elements so essential to produce balance may be expressed in coffee as those having body and those in which acidity is the predominating characteristic. Occasionally a chop possesses both essentials but in general any



PHANTOM VIEW, SHOWING THE GRINDING PROCESS IN ANOTHER COFFEE-GRANULATING MACHINE

(1) First reduction; coarse corrugated cracking rolls. (2) Second reduction; fine roll corrugations. (3) Chaff reducer. (4) Distributor. (5) Third reduction; fine corrugated finishing rolls. (6) Scalper, to remove strings and hulls. (7) Finished coffee mixer.



DETAIL OF COFFEE MIXER IN MODERN GRANULATING MACHINE

of the old brownish, yellowish coffees such as East Indias, Bucaramangas, Maracaibos, etc., give full, rich body. The new crop coffees in such growths as Mexicans, Costa Ricas, Bogotas, etc., have acidity as one of their outstanding characteristics. Certain of the Brazil coffees have acidity and others possess body.

During liberal supply, prudence would choose for blending coffees similar in moisture content, as an aid to attaining a uniform roast. But these are not always available. Formerly, it was believed that varying coffees must be roasted separately; but with modern equipment, having perfect heat control, a skilful operator will obtain uniform results even when moist new crops are used with very dry old coffees. The advanced practice is to blend in the green, and if coffees can stand together they undergo an equalization of moisture content which may be termed "melting." This makes for uniformity of roast and has a tendency to smooth out cup character as well.

With such a wide variety of coffees from which to choose, a coffee blender can make up many combinations to meet the demands of his trade. Generally, no two blenders use exactly the same varieties in exactly the same proportions to make a blend to sell at the same price. However, they all follow the same principles and are guided, in the main, by the flavor classifications here indicated. For more detailed information regarding cup characteristics and trade values readers are referred to Chapter XIX, "Green and Roasted Coffee Characteristics," which includes a complete

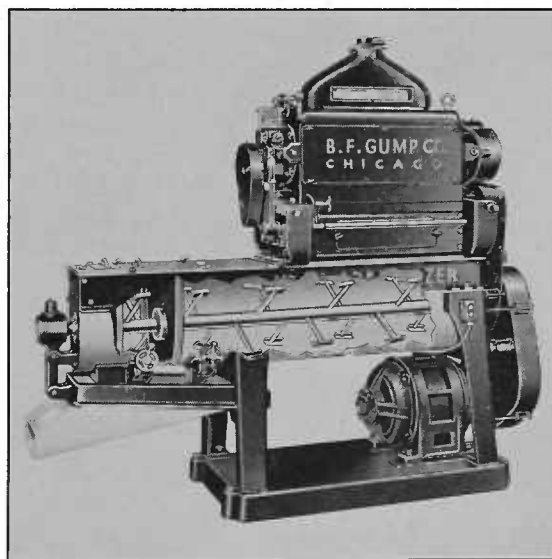
reference table of the principal kinds of coffee grown in the world.

Since no two coffees are identical and each chop possesses an individuality of its own, true values are relative and wise selection resolves itself into a matter of elimination and personal preference. Because any mark or type of coffee will vary from one shipment to another, it becomes necessary for the blender to be able to distinguish slight differences in the cup and to adjust the properties of the various coffees so that the result will be truly a blend and not merely a "mix." For these reasons, and also because of varying price conditions, it is impossible to prepare fixed formulas for blends. All that can be done is to generalize and with this thought in mind the following outline of possible combinations for blends are here presented.

#### *Suggestions for Coffee Blends*

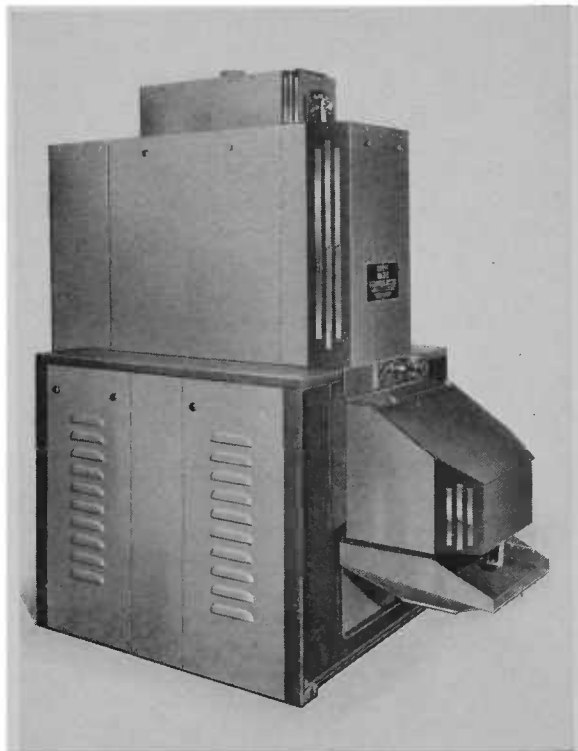
Typical low-priced coffee blends in the United States are sometimes made up from 50 per cent washed Robustas and 50 per cent Colombian Consumos. Another possible combination is 50 per cent Santos 6s and 50 per cent Colombian Consumos.

A medium-priced blend may contain 50 per cent medium grade Bourbon Santos 4s and 50 per cent Colombian Girardots. Another combination in this class could be



CUT-AWAY VIEW, SHOWING CONSTRUCTION OF MIXING CHAMBER IN ANOTHER COFFEE-GRANULATING MACHINE

The good coffee and the flaky chaff fall into the polished steel receptacle, and the steel revolving paddles gradually pulverize the chaff and blend it with the coffee.



**LARGE-CAPACITY COFFEE GRANULATOR**  
Burns coffee-grinding machine capable of producing 3,000 to 5,000 pounds per hour.

one-third medium grade Bourbon Santos 4s, one-third Colombian Consumos, and one-third Cúcuta Maracaibos.

A first quality blend may contain 40 per cent high-grade Bourbon Santos and 60 per cent Colombian Medellins. Another combination in this category might be 40 per cent high-grade Bourbon Santos, 40 per cent Colombian Medellins, and 20 per cent old-crop washed Maracaibos.

The highest-priced blends may contain one-third Colombian Medellins, one-third old crop washed Maracaibos, and one-third acid Mexicans, or two-thirds fancy Ankolas and one-third Mochas.

The foregoing combinations are suitable for either package coffees or for the restaurant trade. It should be emphasized that the coffees mentioned in the suggested blends are but a few of the many growths and grades that may be utilized.

#### *Coffee Cupping Procedure*

In discussing the subject of coffee testing in *The Tea and Coffee Trade Journal*<sup>1</sup> under the title "Removing Guesswork from

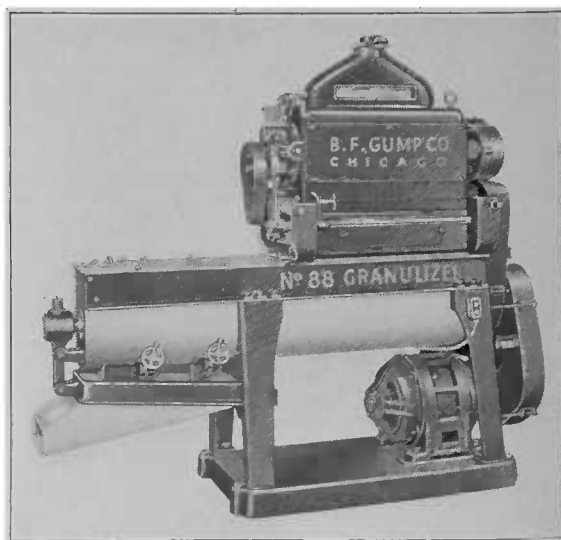
<sup>1</sup>*The Tea and Coffee Trade Journal*, July, 1932 (pp. 40-42).

Coffee Cupping," B. D. Balart goes into interesting and instructive detail as to the exact procedure to be followed in this important adjunct to correct coffee blending. He recommends that, in order to be sure the components of a blend contain the characteristic qualities the blender is seeking, each coffee be cupped in a "blind" draw against a standard. No guesswork should enter into a test of this kind, therefore the blender should provide himself with the following equipment:

- 1 test scale, which must be very accurate.
- 1 doz. cupping glasses, cups, or bowls.
- 1 doz. sample coffee trays.
- 1 boullion spoon.
- 1 cuspidor.
- 1 tea kettle and gas plate or other means for boiling water.
- 1 small mill, to grind samples.

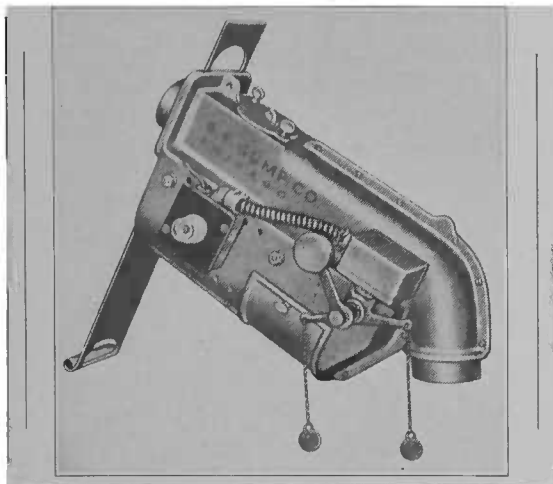
In cupping the individual coffees that are to enter into the blend the best method is as follows:

Place in sample trays a quantity of green and an equal quantity of roasted coffee of each lot that is to be tested. Usually the green coffee jobber will send the buyer a green and a roasted sample of each lot submitted and, provided that the samples are not too long delayed in transit, they should serve the purpose. However, many buyers prefer to make their own sample roasts; not only to be sure that the sample is fresh, but to roast it to the shade to which the buyer is accustomed. Naturally, this re-



**ANOTHER LARGE CAPACITY COFFEE GRINDER**  
This Gump model has a capacity of 3,000 to 5,000 pounds per hour.





UNIT FOR PROTECTING CUTTER PARTS OF FACTORY COFFEE MILLS

The "Ideal" magnetic separator prevents wire nails, bolts, and other iron or steel objects from damaging the cutter parts. It is installed above the coffee mill, and a strong electro-magnet attracts and holds the metal.

quires a sample roaster in addition to the other equipment mentioned.

Place on the sample table—preferably a revolving one, made for this purpose—the samples that are to be drawn, with each pan of roasted coffee on top of the corresponding green pan. In front of each lot place two cups upside down with a sticker pasted on the bottom of each.

Starting at the left, the first two cups are marked No. 1, the next No. 2, and so on until each lot is represented by two cups numbered according to the position of the pans of coffee on the table.

The next step is to carefully weigh into each cup the exact quantity of coffee in the bean, usually the equivalent in weight of a 5c nickel. Some prefer a weight somewhat heavier—that of a nickel and a dime.

After all cups contain the same amount of bean coffee, each cup is dumped separately into the coffee mill and ground to the fineness of corn meal. Care must be taken to clean out the mill before each lot is ground, to get rid of any remaining coffee. This usually is done by grinding a small quantity of the next lot and dumping it out before grinding the weighed sample. Be sure that all of the sample is ground before the ground coffee receptacle is removed from bottom of mill and also that every bit of ground coffee is put back into the cup.

When all samples have been ground, the cups are shuffled around or mixed, after

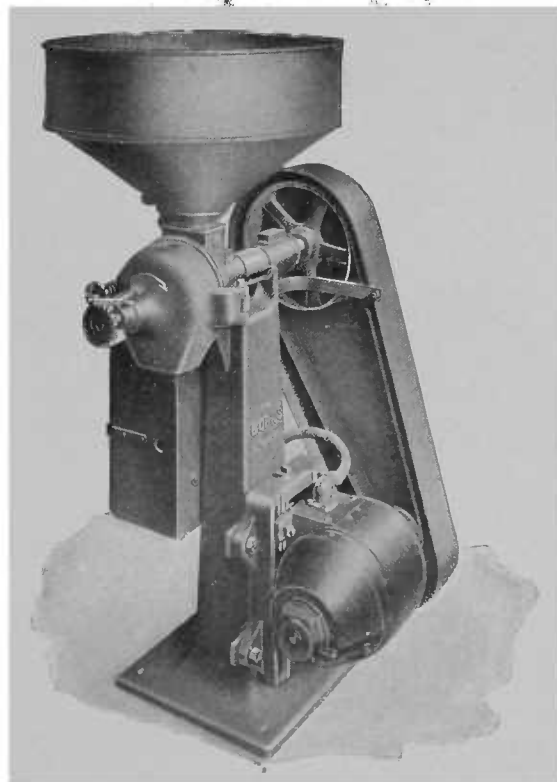
which each cup, starting at the left, is equally filled with actively fresh boiling water.

The cupper then smells each cup without stirring them and either makes a mental note or a pencil note of how they pair up on the table and at the same time his first, second, third choice, etc., down the line, classifying each pair in turn.

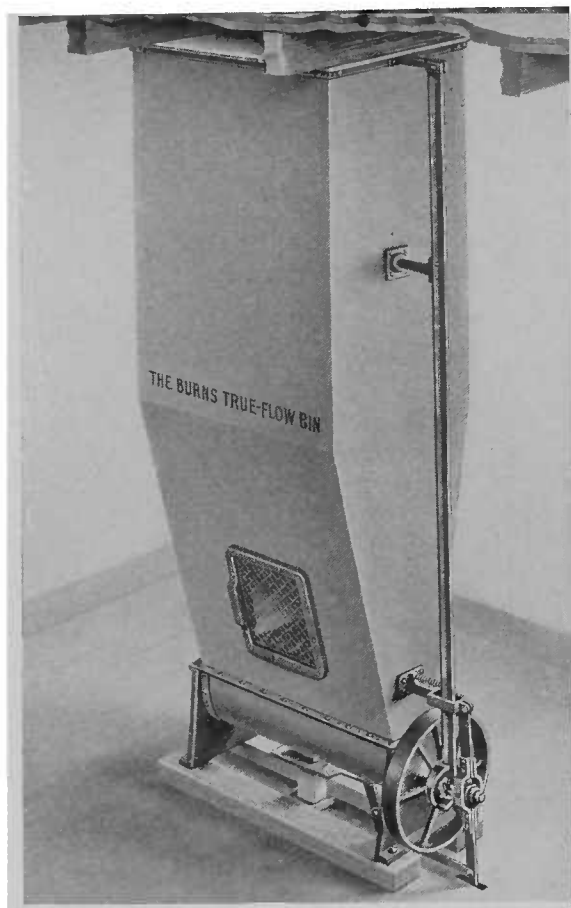
The procedure then is to stir each cup and smell carefully as this is being done. Be sure to rinse off the spoon in a bowl of hot water after each cup is stirred. See if the smell now tallies with the first impression, which may often not be the case, as the coffees develop in the cups.

As the cups cool, most of the grounds will settle to the bottom, but some particles will float, especially in coffees that are quakery; and these floating particles should be carefully skimmed off.

Following this, sip about half a spoonful from the first cup at the left and hold it in the mouth until a definite impression is made. Then spit it out into the cuspidor; do not swallow it. Dip the spoon into the bowl of hot water and sip the next cup. Don't be afraid to make a loud sucking sound, as it is essential to do so; other-



BURNS No. 12 GRINDING MILL  
Designed for hotel and restaurant trade.



**SPECIAL-TYPE RECEPTACLE FOR GROUND COFFEE**  
A floor-height bin, fed from above and designed to prevent the different sized granules of coffee from separating as they flow through the lower part or hopper.

wise, the difference between cups may not be distinguishable.

An independent classification should be made by taste and then compared with the smell classifications, and a lot that is best in both is quite certain to be the best coffee.

In trying to match a standard for a follow-up, the object is to find a coffee nearest to type; therefore, after classifying the cups the task is to find the two cups that represent the standard and the two cups that are closest to it. It easily can happen that some lots may be so close as to make it very hard to distinguish a difference between them, but an expert cupper usually can find a "little something" in the various lots that will enable him to pair them successfully.

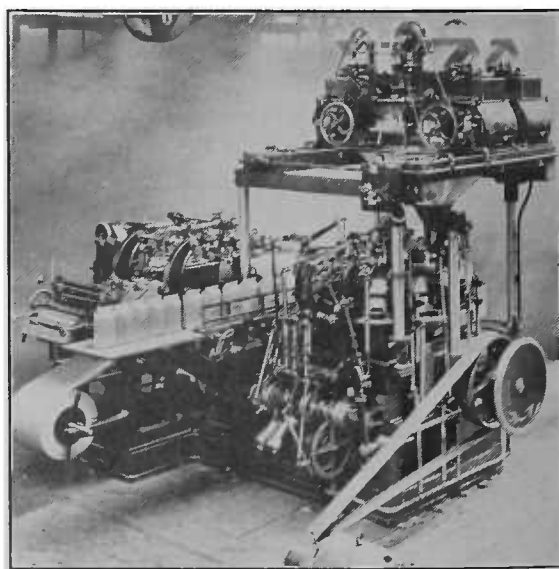
Price naturally must enter into the calculation. For instance, it may develop that sample No. 3 is closest to sample No. 7,

which happens to be the standard; but sample No. 4 also is very close to the standard and costs 1c less than No. 3.

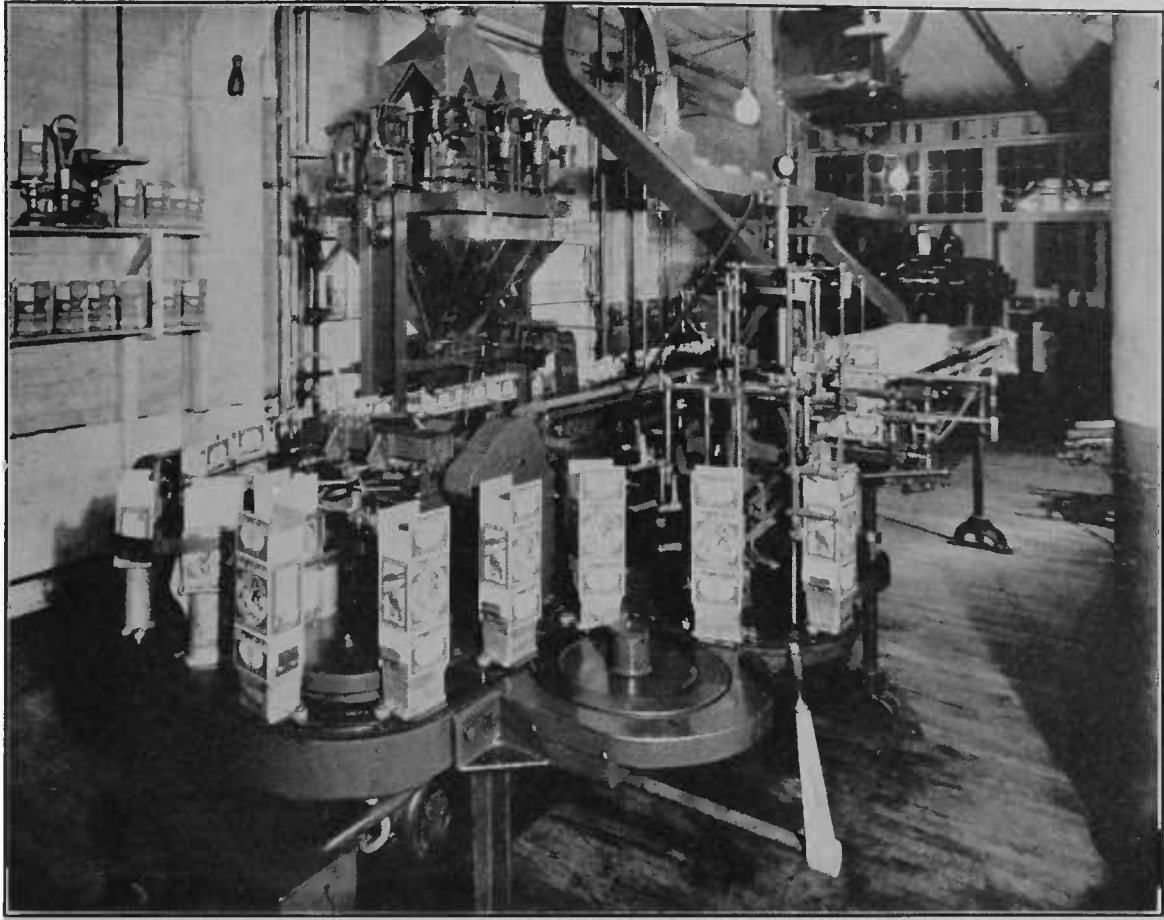
The thing to do then is to compare the style of these three samples, to ascertain if either No. 3 or No. 4 is fully equal in style to the standard; and if so, draw these three samples blend and note the results. If still in doubt, make a couple of trial sample blends, using No. 3 in one and No. 4 in the other. Then cup these two trial blends against the old blend and see if either or both will match it; and if both do, the purchase of the cheaper lot is indicated. In cupping blends it is advisable to grind and mix the ground coffee thoroughly before it is weighed into the cups.

A series of substitutions of coffees in a blend that are "nearly satisfactory" will in time wreck it, because while the difference between, say, substitution No. 1 may be small, and the difference between substitution No. 2 may also be slight, it means that by the time a half dozen "nearly as good" substitutions have been made the blend is as different in the end as day is from night.

If the individual coffees that are being tested have been matched against the standard of these coffees the last step is to mix the component parts and compare them with the standard blend. The latter should, of course, be freshly roasted or packed in



**HESSEY PAPER COFFEE BAG MAKER AND PACKER**  
This machine takes the wrapper and the liner, forms the bag, weighs and fills it with coffee and seals it, in one continuous operation, at the rate of 50 bags per minute.



AUTOMATIC MACHINE FOR PACKAGING COFFEE IN FOLDING CARTONS

This "Pakomatic" installation in a Cleveland roasting plant, sets up cartons, glues the bottom flaps, forms a liner and inserts it, and places a coupon in each carton. The coffee is then automatically weighed and the inner bag and carton sealed, all in one continuous operation. The capacity of this battery of machines is 60 packages a minute, with only three operators.

vacuum. To make the comparison the blender should start by making a trial blend of green coffee and a sample roast of it which he would then "blind cup" against the standard. If the blend cannot be matched the first time, the procedure is continued until the standard and the new blend do not differ in the cup.

The foregoing may sound complicated and the method of cupping unnecessarily tedious, but it has been found that unless coffees are cupped blind, it is next to impossible to be strictly impartial, no matter how hard one may try.

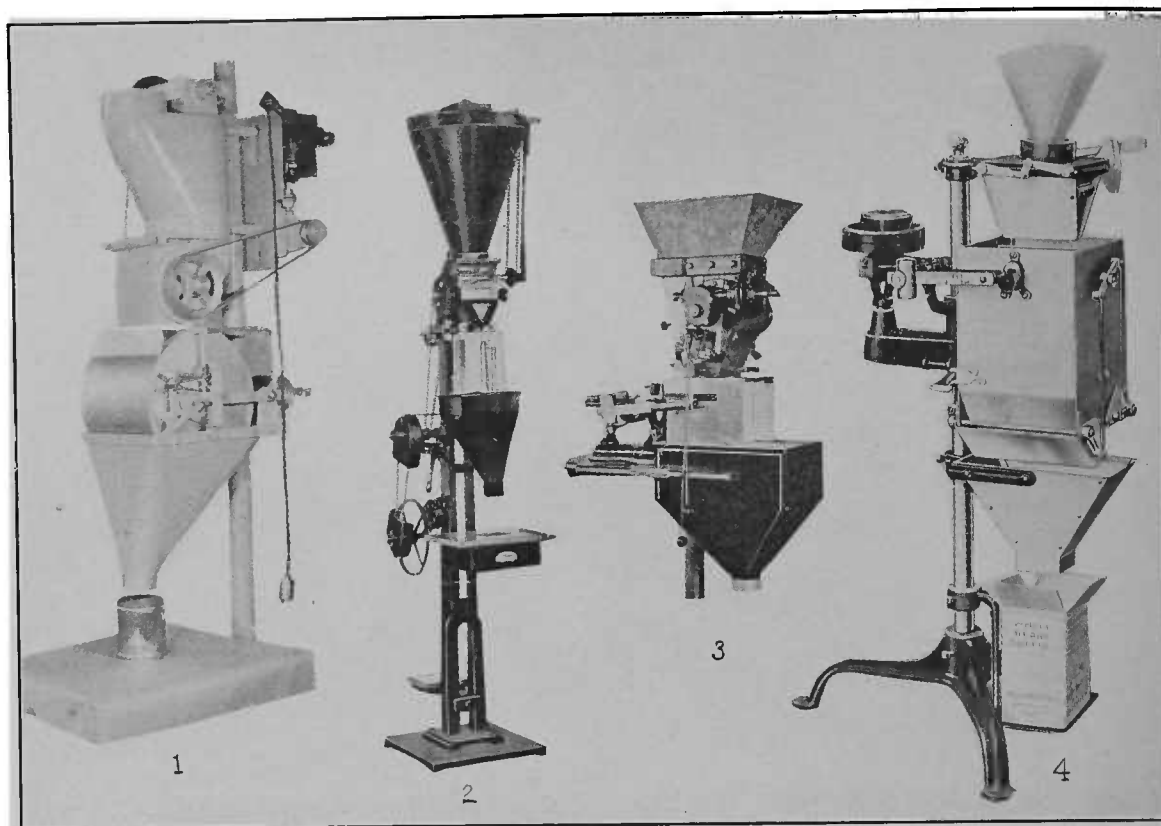
Style cannot be disregarded where coffee is blended to be sold in the bean, but for a restaurant blend or for a family coffee that is sold ground, style can be disregarded except, of course, in cases where a coffee is quakery or contains imperfections that show even after the coffee is ground. In fact, some defects show up even more

plainly in the grounds remaining after extraction has taken place.

Once a decision is reached and the coffees bought, it is advisable to blend the green coffees at once, to equalize the moisture content of the various coffees used. This will facilitate uniformity in roast.

In cup testing the olfactories and the palate cooperate. When the grounds are stirred immediately after the introduction of the boiling water, the first steam yields the strongest flavor and aroma. Then the coffee should be allowed to settle; further agitation makes the coffee muddy. The body and general character is best determined by the palate. As some coffees change in character during the cupping process, it is well to test twice, the first time as soon as the coffees may be sipped and again when they cool somewhat.

In making blends, some cupping experts follow the procedure of taking spoonfuls



FOUR TYPICAL AMERICAN AUTOMATIC COFFEE WEIGHING MACHINES

(1) Franklin power feed weigher. (2) "Triangle" power feed net weigher. (3) National-Scott weigher. (4) "Little Wonder" gravity net weight scale.

from the cups. This enables them to balance proportions much more readily and more accurately than to mix the ground coffee and then test it in the cup.

#### *The Packaging of Coffee*

A large proportion of the coffee sold in the United States is put up in packages. Those most generally used are vacuum tin cans, non-vacuum tin cans with various types of closures, fibre cans with tin tops and bottoms, cardboard cartons, glass jars (either vacuum or non-vacuum), and paper bags.

As the package-coffee business grew in the United States the machinery manufacturers kept pace, so that the packaging process has been greatly accelerated, with resulting economies. There are machines that in one continuous operation open a "flat" paper carton, seal the bottom fold, line the carton with a protecting paper, weigh the coffee as it comes from an overhead hopper into the carton, fold the top and seal it, and then wrap the whole package in waxed or paraffined paper or trans-

parent cellulose, delivering the package ready for shipment without having been touched by a human hand from the first operation to the last.

What is known as a "tight-wrapping" cartoning machine utilizes a plain unprinted carton and a printed-paper wrapper or label. After the carton is filled and sealed the wrapping machine automatically feeds, glues, and then wraps the label around the filled carton, making a tight-sealed package.

Ordinary tin or tin and fibre cans (non-vacuum) are generally filled by placing the can under the spout of an automatic filling and weighing machine by an operator who slips on the cover when the can is properly filled. The weighing machine has a hopper which lets the coffee down into a device that gauges the correct amount, say a pound or two pounds, and then pours it into the can.

Paper bags are filled much the same way as the tin or fibre cans, and those using cartons in comparatively small quantities follow a like procedure.

In the packaging of coffee under vacuum,

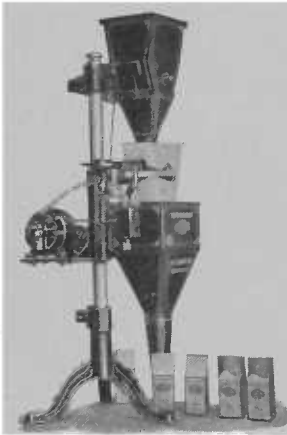
the tin containers are first filled by any of the usual automatic weighing and filling machines. The cans pass, after being filled, to a cover-clinching machine where the covers are loosely clinched to the top of the cans. From this machine they pass into the vacuum chamber by means of a rotary valve. In the vacuum chamber are means which hermetically seal the cans while the air is out of them. They are discharged from the machine by another rotary valve to the operators who pack them in cases ready for shipment.

The foregoing description of the vacuum packing process refers to the "key type" can which is the one most widely used. There are other types of vacuum tins, one of these having a friction lid with a gasket affixed by the can maker which assists in effecting a seal after capping. The friction lid of the can has indentations which "lock the lid" after it has been capped by the closing device in the vacuum machine used with this style container.

For packing coffee in vacuum in glass jars a special type of vacuum machine has been developed. First the jars are labeled, filled, and weighed automatically, and then they are conveyed to the machine

which applies the vacuum and caps and seals the jars.

Most chain grocers use paper bags for coffee to a considerable extent, whole-bean coffee being packed in "tin-tie" bags at the roasting plant. The bags are afterwards opened and ground in the store, as ordered, being resealed and handed to the customer after grinding. Wholesale coffee roasters also use paper bags in large quantities.

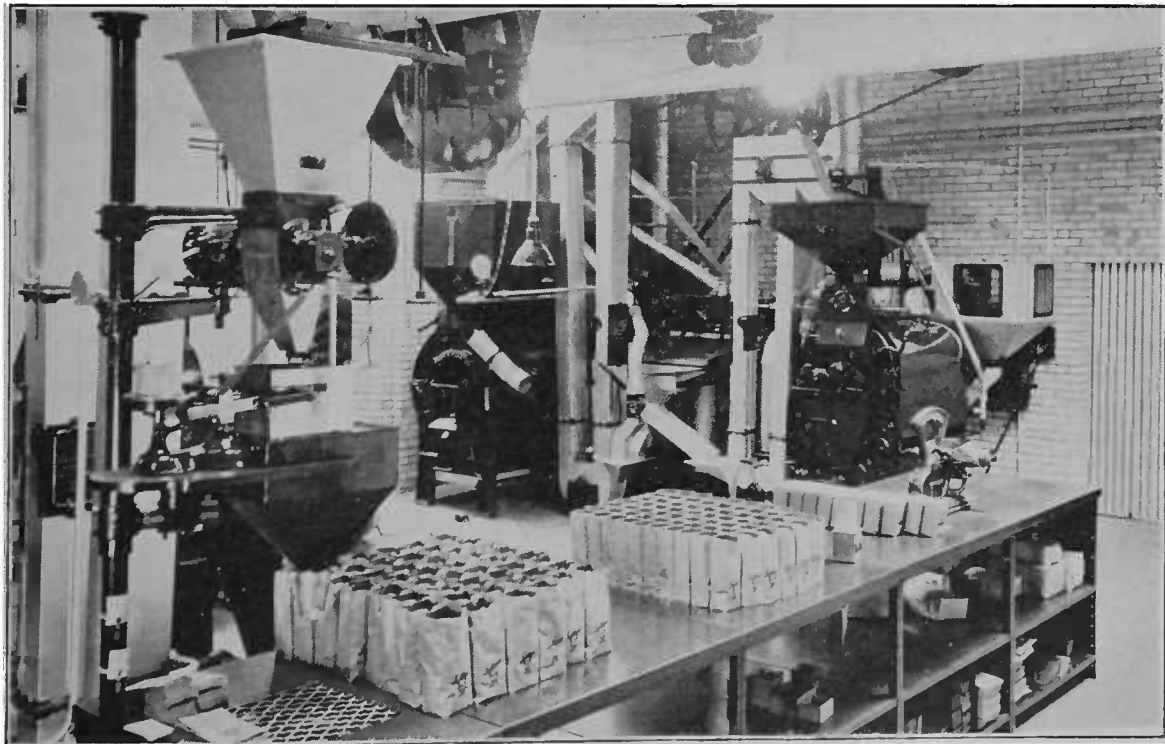


Edtbauer Duplex Automatic Coffee Weigher

Most of the bags for coffee are manufactured by concerns specializing in

this style of coffee container. Some of the larger coffee roasters, however, have installed equipment which makes and fills the bags in one continuous operation. Another type of machine, known as the "Allison," automatically weighs, packs, folds, and seals with gummed tape.

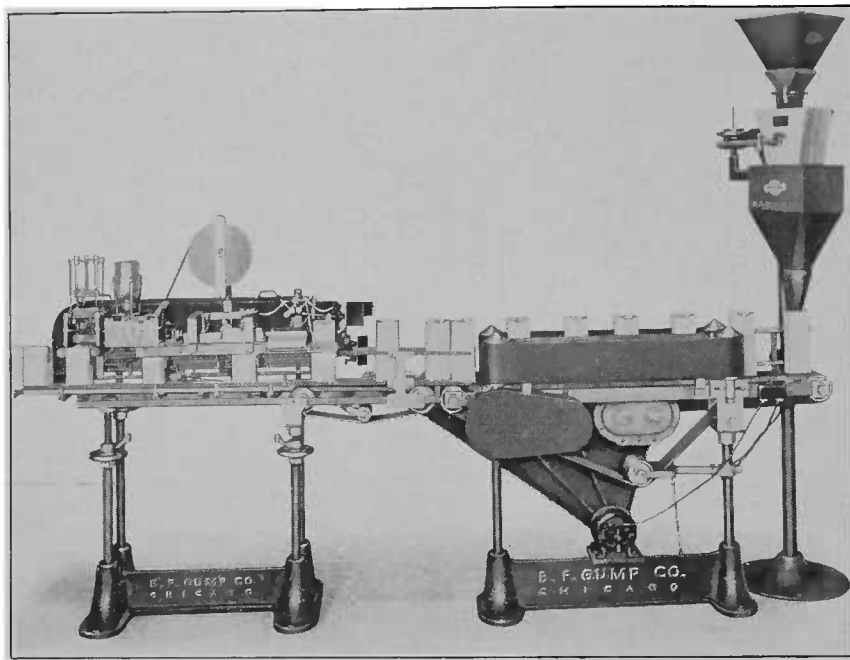
For packing bulk coffee in shipping



PACKAGING COFFEE IN THE PLANT OF A REGIONAL ROASTER

An automatic weighing machine is shown in the left foreground, with roasting equipment in the rear.





MACHINE FOR CLOSING COFFEE BAGS AND AUTOMATIC WEIGHER  
The "Allison" bag-closing device, shown in combination with an Edtbauer coffee weigher, automatically packs, closes and seals, with gummed tape, paper bags for coffee.

drums or burlap bags, automatic machines are available which weigh in lots of twenty-five, fifty, or one hundred pounds. Special protective liners are usually used with these bulk coffee containers. Heavy paper bags are also being used to some extent for bulk coffee and machines for packing and sealing them have been perfected.

#### *Coffee Additions and Fillers*

In all large coffee-consuming countries, coffee additions and fillers have always been used. Large numbers of French, Italian, Dutch, and German consumers insist on having chicory with their coffee, just as do many Southerners in the United States. Roasted cereals are widely consumed in Europe as substitutes for coffee.

The chief commercial reason for using coffee additions and fillers is to keep down the cost of blends. For this purpose, chicory and many kinds of cooked cereals are most generally used; while roasted and ground peas, beans, and other vegetables that will not impair the flavor or aroma of the brew, are frequently employed in foreign countries. Before Parliament passed the Adulterant Act, some British coffee men used as fillers cacao husks, acorns, figs, and lupins, in addition to chicory and the other favorite fillers.

Up to the year 1907, when the United States Food and Drugs Act became effective, chicory and cereal additions were widely used by coffee packers and retailers in this country. With the enforcement of the law requiring that the label of a package so state when a filler is employed, the use of additions gradually fell off in most sections.

In botanical description and chemical composition chicory, the most favored addition, has no relationship with coffee. When roasted and ground, it resembles coffee in appearance;

but it has an entirely different flavor. However, many coffee-drinkers prefer their beverage with this alien flavor added to it.

#### *Treated Coffees, Dry and Liquid Extracts*

The manufacture of prepared, or refined, coffees has become an important business in the United States and Europe. Prepared coffees can be divided into three general groups: treated coffees, from which the caffeine has been removed to some degree; dry coffee extracts (soluble coffee), which are readily dissolved in a cup of hot or cold water; and liquid coffee concentrate, to which water is added for making the coffee beverage.

To decaffeinate coffee, the most common practice is to make the green beans soft by steaming under pressure, and then to apply benzol, chloroform, or alcohol to the softened coffee to dissolve and to extract the caffeine. Afterward, the extracting solvents are driven out of the coffee by re-steaming. However, chemists have not yet been able to expel all the caffeine in treating coffee commercially, the best efforts resulting in from 0.3 to 0.07 per cent remaining. After treatment, the coffee beans are roasted, packed, and sold like ordinary coffee.

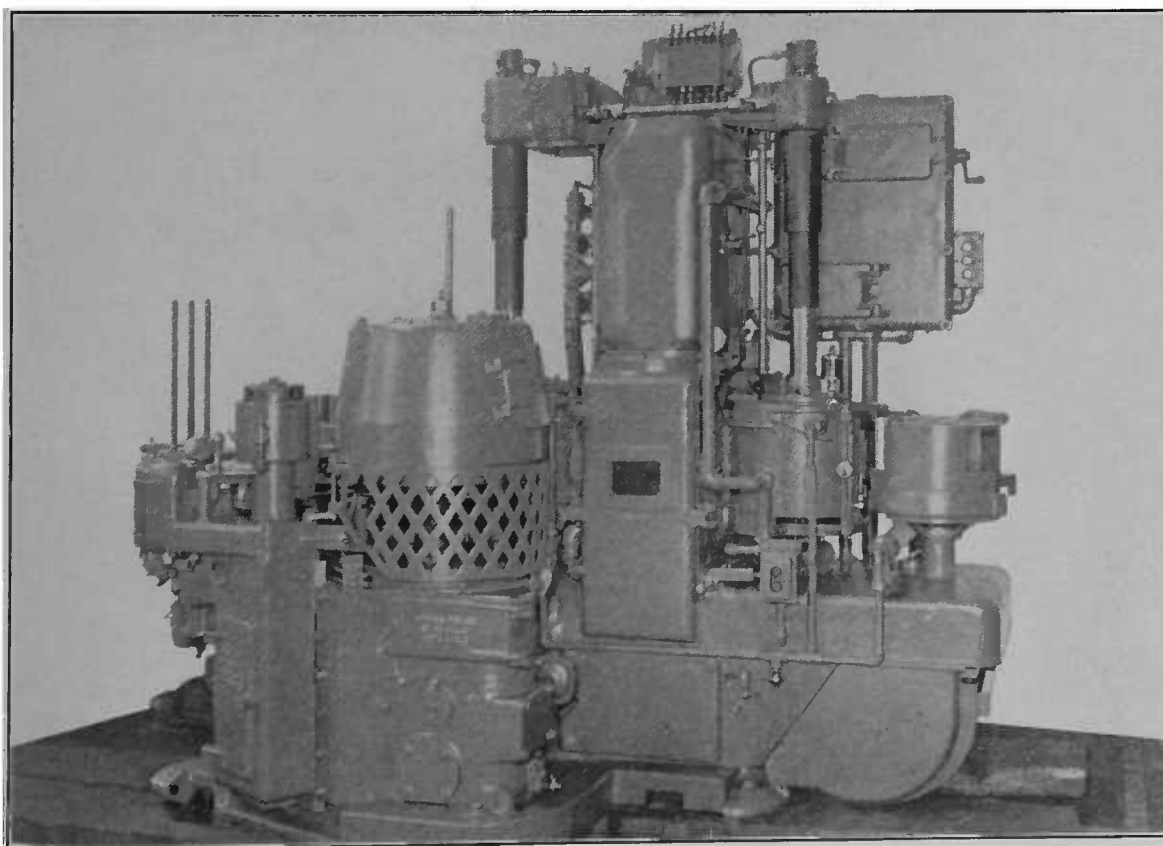
**SOLUBLE COFFEE.** In manufacturing dry coffee extract in the form of a powder that

is readily soluble in water, the general method is to extract the drinking properties from ground roasted coffee by means of water, and to evaporate the resulting liquid until only the coffee powder is left. Several methods have been developed and patented to prevent the valuable flavor elements from being evaporated with the water.

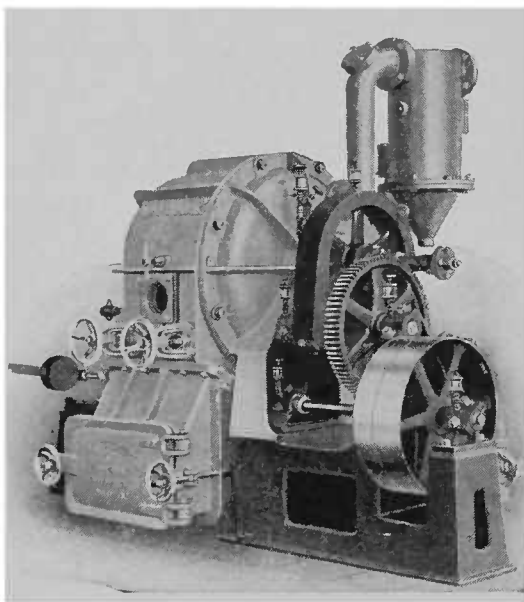
A typical dry-coffee extract-making equipment consists of a battery of percolators, or "leachers," a vacuum evaporating device, and a vacuum drier. The leachers do not differ materially from the ordinary restaurant percolators, a battery usually including from three to seven units, each charge of water going through all the percolations. The resulting heavy liquid then goes to the evaporator to be concentrated into a thick liquor. The evaporator consists of a horizontal cylindrical vapor compartment connected with an inclined cylindrical steam chest in which are numerous tubes, or flues, that occupy almost the whole chest. These tubes are heated by

steam. The coffee liquor is passed through the tubes at high speed and thrown with great force against a baffle plate at the opening to the vapor chest. The vapor passes around the baffle plate to a separator. The liquor drops to the lower part of the steam-chest, which is free from tubes, and is ready to be drawn off for the next process, the drying.

At this stage, the extract is a heavily concentrated syrup and is ready to be converted into powder. This is done in the vacuum drier, which consists of a hollow revolving drum surrounded by a tightly sealed cast-iron casing. The drum is heated by steam injected into its interior, and is revolved in a high vacuum. In operation, a coating of coffee liquor is applied automatically, by means of a special device, to the outside of the drum. The liquor is taken by gravity from the reservoir containing the liquid supply and is forced upward by means of a pump into the liquid supply pan, directly under the drum, with sufficient pressure to cause the liquid to

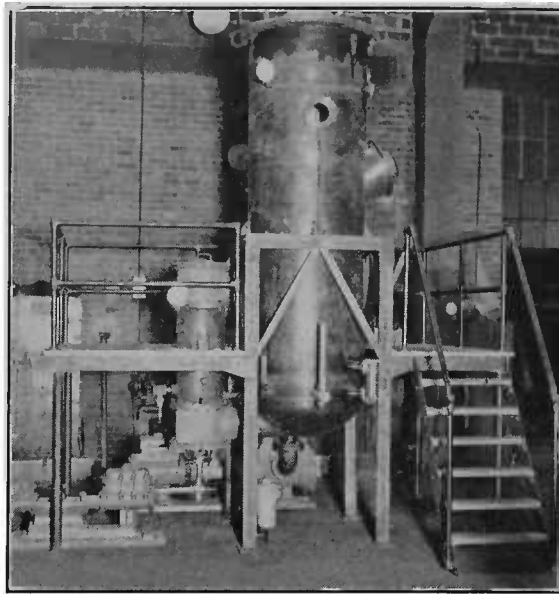


**CLOSE-UP OF MACHINE FOR VACUUMIZING COFFEE CANS AND HERMETICALLY SEALING THEM**  
Front view of an American Can Company vacuum coffee packing machine. The cans and covers enter at the left, the vacuumizing takes place in the center chamber and the cans are discharged at the extreme right.



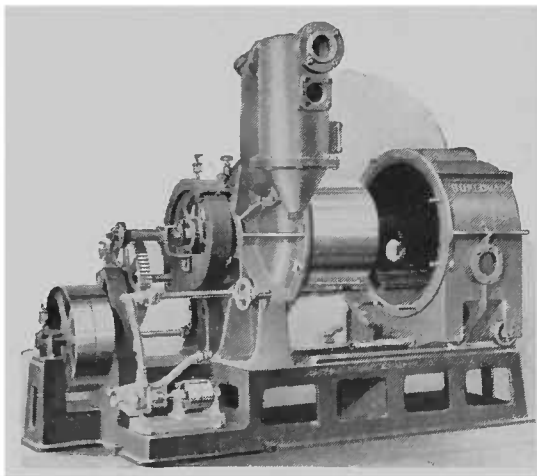
**VACUUM DRUM DRIER**

Vacuum drum drier, No. 1 size; diameter of drum, 12 inches; length, 20 inches; used for converting coffee extracts and other liquids into dry powder form. This is the smallest size, and was developed for drying smaller quantities of liquids than could be handled economically in the larger sizes. To provide accessibility of the interior for cleansing, the outer casing may be moved back on the track of the bedplate (as shown in the cut), so that free access may be had to the drum and interior of the casing.



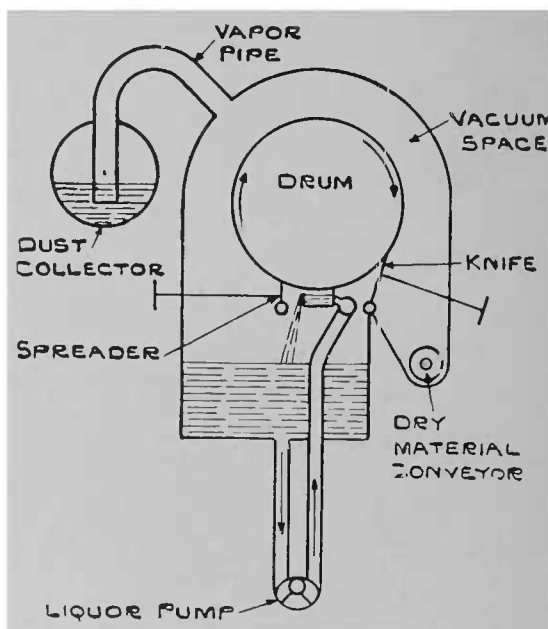
**RAPID-CIRCULATION EVAPORATOR**

Used to concentrate coffee extracts and other liquids. The tubes are easily reached through the open door for cleansing. Interior of the vapor body is reached through a manhole.



**REAR VIEW OF DRUM DRIER**

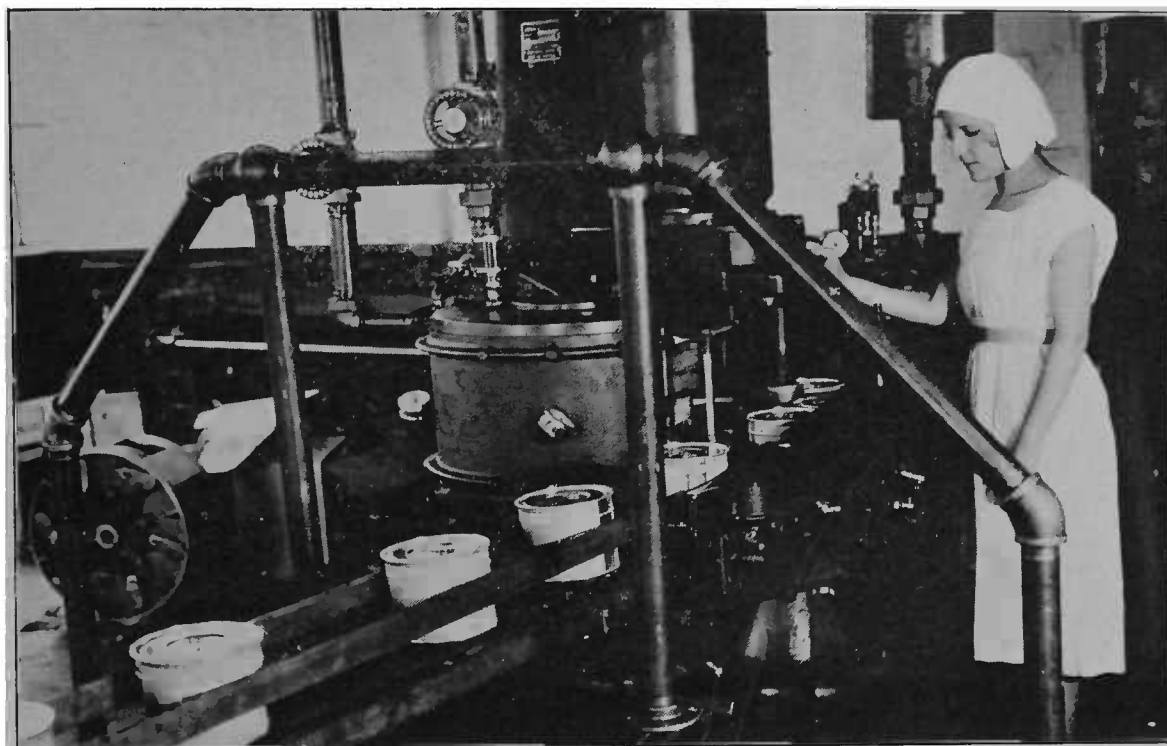
Vacuum drum dryer, No. 1 size; rear view, showing outer casing rolled back from the drum.



**CROSS-SECTION OF VACUUM DRIER**

This shows the interior arrangement and principle of operation. The drawing represents a larger size than the photograph, and while the arrangement of some parts is slightly different, the principle of operation is the same.

**UNITS USED IN THE MANUFACTURE OF SOLUBLE COFFEE**



VACUUM CLOSING MACHINE IN THE MAXWELL HOUSE COFFEE-ROASTING PLANT, NEW YORK  
The cans are traveling from the vacuum chamber following the completion of the sealing process. The operation is largely mechanical, very little supervision being necessary.

adhere to the drum, the excess liquor overflowing from the pan into the reservoir. The coating on the drum is controlled or regulated by a spreader. The heat and the vacuum reduce the extract to a dry powder in less than one revolution of the drum. As the drum completes three-quarters of a turn, a scraper knife removes the coffee powder, which is delivered to a receiver below the drum. Modern vacuum-drum driers have a capacity of from twenty-five to five hundred pounds of dry soluble coffee per hour.

There are several brands of soluble coffee which enjoy an extensive sale in England. In the United States the sale of coffee in this form is largely limited to one brand which has been on the market for a number of years and is well established. Soluble coffee is used to a considerable extent by apartment house dwellers doing light housekeeping, for picnics and camping, and there is also a considerable demand for it by small lunch rooms and soda fountains.

**LIQUID COFFEE.** C. W. Trigg and W. A. Hamor were granted a patent in the United States, in 1919, on a new process for making an aromatized coffee extract. In this

process, the caffeol of the coffee is volatilized and then brought into contact with an absorbing medium such as is used in the extraction of perfumes. The absorbing medium is then treated with a solvent of the caffeol, and the solution is separated from the petrolatum. Then the coffee solution is concentrated to an extract by evaporation; after which, the extract and the caffeol are combined into a soluble coffee. Five additional patents were granted on this same process in 1921.

During the past ten years a number of liquid coffee brands have been placed on the market in the United States. The sponsors claimed new manufacturing processes which produced a superior product, but most of them were short-lived and none enjoy a wide sale. Difficulty has been experienced in producing a liquid product that compares with regular coffee in cup quality, also one that will retain its flavor for any length of time. The subject was discussed in a series of articles published during 1931 in *The Tea and Coffee Trade Journal* (May, June, July, August, and September issues), the conclusion reached as a result of this inquiry being that liquid-coffee manufacture had not progressed far



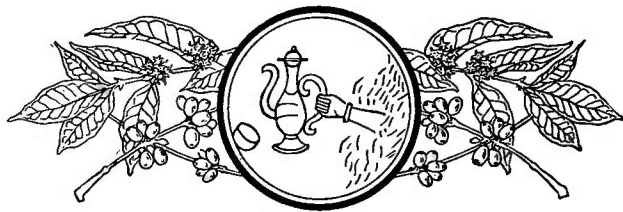
A GENERAL CAN COMPANY COFFEE VACUUM CLOSING MACHINE IN OPERATION

enough and that its place in coffee distribution would have to await further developments. Although some advance has been made since then, the situation today remains relatively the same.

**TABLET COFFEE.** Coffee in tablet form also has some vogue, a few brands being on the market in Europe and the United

States. Their sale, however, is quite limited. In 1934, the Coffee Board of Kenya, East Africa, purchased an interest in the manufacture and distribution of a new type of coffee tablet ["Kondor"] which, it is claimed, produces a superior beverage without the use of a "binder"; most tablets hitherto manufactured containing some substance designed to keep the tablet intact. The arrangement entered into by the Kenya coffee growers provided for the use of 60 per cent Kenya coffee in the tablets. Actual distribution in England started in 1934.

**FLAKE COFFEE.** Another prepared coffee developed in the United States is known as "flake coffee," patents for which were obtained in 1934, as a result of an investigation conducted at the Mellon Institute of Industrial Research, sponsored by the Continental Can Co., New York. Ground coffee is "flaked" by passing it through a roller mill under pressure by which means the particles are converted into thin flat flakes averaging about 0.06 inch in diameter and about 0.003 inch in thickness. The sponsor claims that by means of this flaking operation the soluble constituents of the coffee become instantly accessible to the water, resulting in quick and efficient extraction. Further reference to flake coffee may be found in Chapter XXXVI.





**BOOK III**  
**SCIENTIFIC ASPECTS**



## CHAPTER XXI

### THE ETYMOLOGY OF COFFEE

THE DERIVATION OF THE WORD FOR THE PLANT, DRIED BEANS OR SEEDS, AND BEVERAGE IN THE LANGUAGES OF THE CIVILIZED WORLD, AS OBTAINED DIRECT FROM ARABIA—QUOTATIONS FROM MANY OF THE EARLY NOTICES OF COFFEE, SHOWING THE EVOLUTION OF THE WORD BEFORE ITS FINAL ADOPTION INTO THE LANGUAGES OF EUROPE—THE WORD IN VARIOUS MODERN LANGUAGES

THE European languages got the name coffee about A. D. 1600 from the original Arabic قهوة *qahwah*, not directly, but through its Turkish form, *kahveh*. This was the name, not of the plant, but of the beverage made from its infusion, being originally one of the names employed for wine in Arabic.

Sir James Murray, in the *New English Dictionary*, says that some have conjectured that the word is a foreign, perhaps African, word disguised, and have thought it connected with the name Kaffa, a town in Shoa, southwest Ethiopia, reputed native place of the coffee plant, but that of this there is no evidence, and the name *qahwah* is not given to the berry or plant, which is called بون *bunn*, the native name in Shoa being *būn*.

Contributing to a symposium on the phonetic problems involved in tracing the etymology of the word coffee in *Notes and Queries*, 1909, James Platt, Jr., wrote:

The Turkish form might have been written *kahvé*, as its final *h* was never sounded at any time. Sir James Murray draws attention to the existence of two European types, one like the French *café*, Italian *caffè*, the other like the English *coffee*, Dutch *koffie*. He explains the vowel *o* in the second series as apparently representing *au*, from Turkish *ahv*. This seems unsupported by evidence, and the *v* is already represented by the *ff*, so on Sir James's assumption *coffee* must stand for *kahv-ve*, which is unlikely. The change from *a* to *o*, in my opinion, is better accounted for as an imperfect appreciation. The exact sound of *ā* in Arabic and other Oriental languages is that of the English short *u*, as in "cuff." This sound, so easy to us, is a great stumbling-block to other na-

tions. I judge that Dutch *koffie* and kindred forms are imperfect attempts at the notation of a vowel which the writers could not grasp. It is clear that the French type is more correct. The Germans have corrected their *koffie*, which they may have got from the Dutch, into *kaffee*. The Scandinavian languages have adopted the French form. Many must wonder how the *hv* of the original so persistently becomes *ff* in the European equivalents. Sir James Murray makes no attempt to solve this problem.

Virendranath Chattopādhyāya, who also contributed to the *Notes and Queries* symposium, argued that the *hw* of the Arabic *qahwah* becomes sometimes *ff* and sometimes only *f* or *v* in European translations because some languages, such as English, have strong syllabic accents (stresses), while others, as French, have none. Again, he points out that the surd aspirate *h* is heard in some languages, but is hardly audible in others. Most Europeans tend to leave it out altogether.

Col. W. F. Prideaux, another contributor, argued that the European languages got one form of the word coffee directly from the Arabic *qahwah*, and quoted from Hobson-Jobson in support of this:

*Chaoua* in 1598, *Cahoa* in 1610, *Cahue* in 1615; while Sir Thomas Herbert (1638) expressly states that "they drink (in Persia) \* \* \* above all the rest, *Coho* or *Copha*: by Turk and Arab called *Caphe* and *Cahua*." Here the Persian, Turkish, and Arabic pronunciations are clearly differentiated.

Col. Prideaux then calls, as a witness to the Anglo-Arabic pronunciation, one whose evidence was not available when the *New English Dictionary* and Hobson-Jobson articles were written. This is John Jour-

dain, a Dorsetshire seaman, whose *Diary* was printed by the Hakluyt Society in 1905. On May 28, 1609, he records that "in the afternoon wee departed out of Hatch (Al-Hauta, the capital of the Lahej district near Aden), and travelled untill three in the morninge, and then wee rested in the plaine fields untill three the next daie, neere unto a coho howse in the desert." On June 5 the party, traveling from Hippa (Ibb), "laye in the mountaynes, our camells being wearie, and our selves little better. This mountain is called Nasmarde (Nakil Sumāra), where all the coho grows." Farther on was "a little village, where there is sold coho and fruite. The seeds of this coho is a greate marchandize, for it is carried to grand Cairo and all other places of Turkey, and to the Indias." Prideaux, however, mentions that another sailor, William Revett, in his journal (1609) says, referring to Mocha, that "Shamer Shadli (Shaikh 'Ali bin 'Omar esh-Shādil) was the fyrst inventour for drynking of coffe, and therefor had in esteemation." This rather looks to Prideaux as if on the coast of Arabia, and in the mercantile towns, the Persian pronunciation was in vogue; whilst in the interior, where Jourdain traveled, the Englishman reproduced the Arabic.

Mr. Chattopādhyāya, discussing Col. Prideaux's views as expressed above, wrote:

Col. Prideaux may doubt "if the worthy mariner, in entering the word in his log, was influenced by the abstruse principles of phonetics enunciated" by me, but he will admit that the change from *kahvah* to *coffee* is a phonetic change, and must be due to the operation of some phonetic principle. The average man, when he endeavours to write a foreign word in his own tongue, is handicapped considerably by his inherited and acquired phonetic capacity. And, in fact, if we take the quotations made in "Hobson-Jobson," and classify the various forms of the word *coffee* according to the nationality of the writer, we obtain very interesting results.

Let us take Englishmen and Dutchmen first. In Danvers's *Letters* (1611) we have both "*coho pots*" and "*coffao pots*"; Sir T. Roe (1615) and Terry (1616) have *cohu*; Sir T. Herbert (1638) has *coho* and *copha*; Evelyn (1637), *coffee*; Fryer (1673) *coho*; Ovington (1690), *coffee*; and Valentijn (1726), *coffi*. And from the two examples given by Col. Prideaux, we see that Jourdain (1609) has *coho*, and Revett (1609) has *coffe*.

To the above should be added the following by English writers, given in Foster's *English Factories in India* (1618-21, 1622-23, 1624-29): *cowha* (1619), *cowhe*, *couha* (1621), *coffa* (1628).

Let us now see what foreigners (chiefly French and Italian) write. The earliest European mention is by Rauwolf, who knew it in Aleppo in 1573. He has the form *chaube*. Prospero Alpini (1580) has *caova*; Paludanus (1598) *chaoua*; Pyrard de Laval (1610) *cahoa*; P. Della Valle (1615) *cahue*; Jac. Bontius (1631) *caveah*; and the *Journal d'Antoine Galland* (1673) *cave*. That is, Englishmen use forms of a certain distinct type, *viz.*, *cohu*, *coho*, *coffao*, *coffe*, *copha*, *coffee*, which differ from the more correct transliteration of foreigners.

In 1610 the Portuguese Jew, Pedro Teixeira (see the Hakluyt Society's edition of his *Travels*) used the word *kavāh*.

The inferences from these transitional forms seem to be: 1. The word found its way into the languages of Europe both from the Turkish and from the Arabic. 2. The English forms (which have strong stress on the first syllable) have *ō* instead of *ā*, and *f* instead of *h*. 3. The foreign forms are unstressed and have no *h*. The original *v* or *w* (or labialized *u*) is retained or changed into *f*.

It may be stated, accordingly, that the chief reason for the existence of two distinct types of spelling is the omission of *h* in unstressed languages, and the conversion of *h* into *f* under strong stress in stressed languages. Such conversion often takes place in Turkish; for example, *silah dar* in Persian, which is a highly stressed language, becomes *zilif dar* in Turkish. In the languages of India, on the other hand, in spite of the fact that the aspirate usually is clearly sounded, the word *qāhvāh* is pronounced *kaiva* by the less educated classes, owing to the syllables being equally stressed.

Now for the French viewpoint. Jardin opines that, as regards the etymology of the word *coffee*, scholars are not agreed and perhaps never will be.<sup>1</sup> Dufour says the word is derived from *caouhe*, a name given by the Turks to the beverage prepared from the seed.<sup>2</sup> Chevalier d'Arvieux, French consul at Alet, Savary, and Trevoux, in his dictionary, thinks that *coffee* comes from the Arabic, but from the word *cahoueh* or *quaweh*, meaning to give vigor or strength, because, says d'Arvieux, its most general effect is to fortify and strengthen. Taver-

<sup>1</sup> Jardin, Édelestan. *Le Cafétier et le Café*. Paris, 1895 (p. 55).

<sup>2</sup> Dufour, Philippe Sylvestre. *Traité Nouveau et Curieux du Café, du Thé, et du Chocolat*. Lyons, 1684.

nier combats this opinion. Moseley attributes the origin of the word coffee to Kaffa. Sylvestre de Sacy, in his *Chrestomathie Arabe*, published in 1806, thinks that the word *kahwa*, synonymous with *makli*, roasted in a stove, might very well be the etymology of the word coffee. D'Alembert in his encyclopedic dictionary, writes the word *caffé*. Jardin concludes that whatever there may be in these various etymologies, it remains a fact that the word coffee comes from an Arabian word, whether it be *kahua*, *kahoueh*, *kaffa*, or *kahwa*, and that the peoples who have adopted the drink have all modified the Arabian word to suit their pronunciation. This is shown by the word as written in various modern languages:

French, *café*; Breton, *kafe*; German, *kaffee* (coffee tree, *kaffeebaum*); Dutch, *koffie* (coffee tree, *koffieboom*); Danish, *kaffe*; Finnish, *kahvi*; Hungarian, *kavé*;

Bohemian, *kava*; Polish, *kawa*; Roumanian, *cafea*; Croatian, *kafa*; Servian, *kava*; Russian, *kophe*; Swedish, *kaffe*; Spanish, *café*; Basque, *kaffia*; Italian, *caffè*; Portuguese, *café*; Latin (scientific), *coffea*; Turkish, *kahvé*; Greek, *kaféo*; Arabic, *qahwah* (coffee berry, *bun*); Persian, *qéhvé* (coffee berry, *bun*<sup>3</sup>); Annamite, *ca-phé*; Cambodian, *kafé*; Dukni<sup>4</sup>, *bunbund*<sup>5</sup>; Teluyan<sup>4</sup>, *kapri-vittulu*; Tamil<sup>4</sup>, *kapi-kottai* or *kopi*; Canareze<sup>4</sup>, *kapi-bija*; Chinese, *kia-fey*, *teoutsé*; Japanese, *kéhi*; Malayan, *kawa*, *koppi*; Ethiopian, *bonn*<sup>6</sup>; Foulak, *legal café*<sup>7</sup>; Sousou, *hourri caff*<sup>7</sup>; Marquesan, *kapi*; Chinook<sup>8</sup>, *kaufee*; Volapuk, *kaf*; Esperanto, *kafva*.

<sup>3</sup> Coffee covered with the skin is called *boun*, and the coffee-tree *boun-tree* (*sejar et boun*).

<sup>4</sup> These four dialects are spoken in Hindustan.

<sup>5</sup> Notice must be taken of the similarity in the names of coffee in Hindustani and Ethiopian, and of the name of the coffee-tree as given by ancient authors.

<sup>6</sup> See note 3 above.

<sup>7</sup> *Legal* and *Hourri* mean tree.

<sup>8</sup> North-American Indian.







A CLOSE-UP OF THE LEAVES AND BERRIES OF COFFEA ARABICA

## CHAPTER XXII

### THE BOTANY OF THE COFFEE PLANT

ITS COMPLETE CLASSIFICATION BY CLASS, SUB-CLASS, ORDER, FAMILY, GENUS, AND SPECIES—HOW *Coffea arabica* GROWS, FLOWERS, AND BEARS FRUIT—OTHER SPECIES AND HYBRIDS DESCRIBED—NATURAL CAFFEINE-FREE COFFEE—FUNGOID DISEASES OF COFFEE

THE coffee tree, scientifically known as *Coffea arabica*, is indigenous to Ethiopia (Abyssinia), but grows well in Java, Sumatra, and other islands of the Netherlands Indies; in India, Arabia, equatorial Africa, the islands of the Pacific, in Mexico, Central and South America, and the West Indies. The plant belongs to the large sub-kingdom of plants known scientifically as the Angiosperms, or *Angiospermæ*, which means that the plant reproduces by seeds which are enclosed in a box-like compartment, known as the ovary, at the base of the flower. The word Angiosperm is derived from two Greek words, *sperma*, a seed, and *aggeion*, pronounced *angeion*, a box, the box referred to being the ovary.

This large sub-kingdom is subdivided into two classes. The basis for this division is the number of leaves in the little plant which develops from the seed. The coffee plant, as it develops from the seed, has two little leaves, and therefore belongs to the class *Dicotyledoneæ*. This word *dicotyledoneæ* is made up of the two Greek words, *di(s)*, two, and *kotyledon*, cavity or socket. It is not necessary to see the young plant that develops from the seed in order to know that it had two seed leaves; because the mature plant always shows certain characteristics that accompany this condition of the seed.

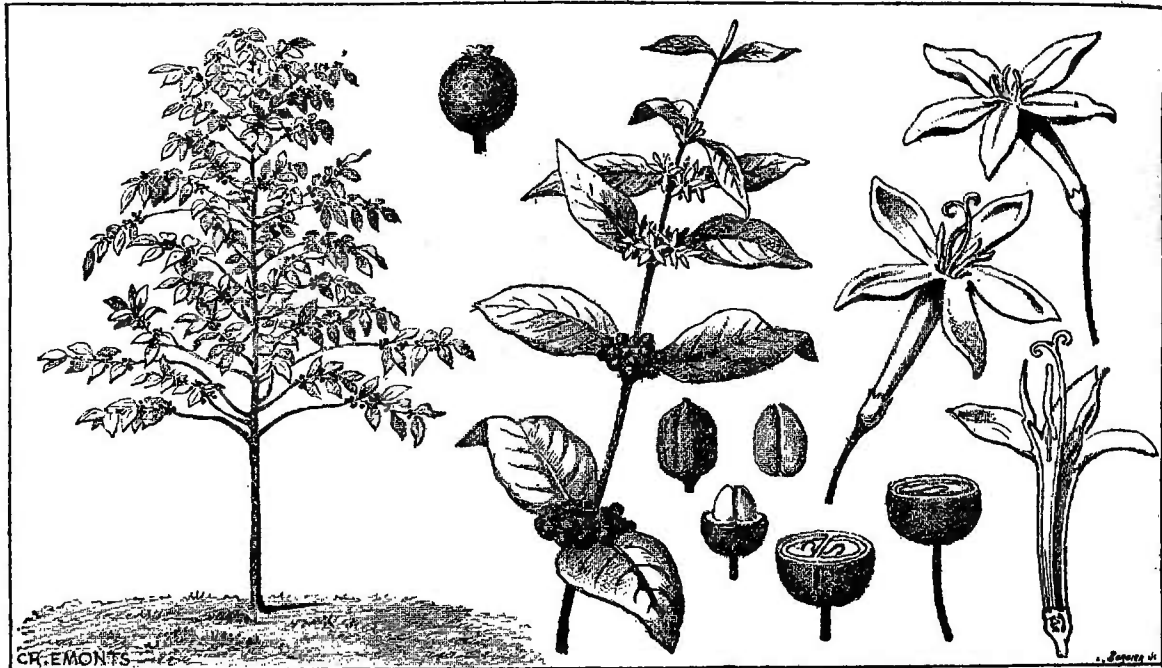
In every plant having two seed leaves, the mature leaves are netted-veined, which is a condition easily recognized even by the layman; also the parts of the flowers are in circles containing two or five parts, but never in threes or sixes. The stems of

plants of this class always increase in thickness by means of a layer of cells known as a cambium, which is a tissue that continues to divide throughout its whole existence. The fact that this cambium divides as long as it lives, gives rise to a peculiar appearance in woody stems by which we can, on looking at the stem of a tree of this type when it has been sawed across, tell the age of the tree.

In the spring the cambium produces large open cells through which large quantities of sap can run; in the fall it produces very thick-walled cells, as there is not so much sap to be carried. Because these thin-walled open cells of one spring are next to the thick-walled cells of the last autumn, it is very easy to distinguish one year's growth from the next; the marks so produced are called annual rings.

We have now classified coffee as far as the class; and so far we could go if we had only the leaves and stem of the coffee plant. In order to proceed further, we must have the flowers of the plant, as botanical classification goes from this point on the basis of the flowers. The class *Dicotyledoneæ* is separated into sub-classes according to whether the flower's corolla—the showy part of the flower which ordinarily gives it its color—is all in one piece, or is divided into a number of parts. The coffee flower is arranged with its corolla all in one piece, forming a tube-shaped arrangement, and accordingly the coffee plant belongs to the sub-class *Sympetalæ*, or *Metachlamydeæ*, which means that its petals are united.

The next step in classification is to place



THE COFFEE TREE, SHOWING DETAILS OF FLOWERS AND FRUIT  
From a drawing by Ch. Emonts in 'Jardin's *Le Caf tier et Le Caf *

the plant in the proper division under the sub-class, which is the order. Plants are separated into orders according to their varied characteristics. The coffee plant belongs to an order known as *Rubiales*. These orders are again divided into families. Coffee is placed in the family *Rubiaceae*, or Madder Family, in which we find herbs, shrubs or trees, represented by a few American plants, such as bluets, or Quaker ladies, small blue spring flowers, common to open meadows in northern United States; and partridge berries (*Mitchella repens*).

The Madder Family has more foreign representatives than native genera, among which are *Coffea*, *Cinchona*, and *Ipecacuanha* (*Uragoga*), all of which are of economic importance. The members of this family are noted for their action on the nervous system. Coffee contains an active principle known as caffeine which acts as a stimulant to the nervous system and in small quantities is very beneficial. *Cinchona* supplies us with quinine, while *Ipecacuanha* produces ipecac, which is an emetic and purgative.

The families are divided into smaller sections known as genera, and to the genus *Coffea* belongs the coffee plant. Under this genus *Coffea* are several sub-genera, and to the sub-genus *Eucoffea* belongs our common

coffee, *Coffea arabica*. *Coffea arabica* is the old original or common Java coffee of commerce. The term "common" coffee may seem unnecessary, but there are many other species of coffee besides *arabica*. These species have not been described very frequently because their native haunts are the tropics, and the tropics do not always offer favorable conditions for the study of plants.

All botanists do not agree in their classification of the species and varieties of the *Coffea* genus. M. E. de Wildman, curator of the royal botanical gardens at Brussels, in his *Les Plantes Tropicales de Grande Culture*, says the systematic division of this interesting genus is far from finished; in fact, it may be said hardly to be begun.

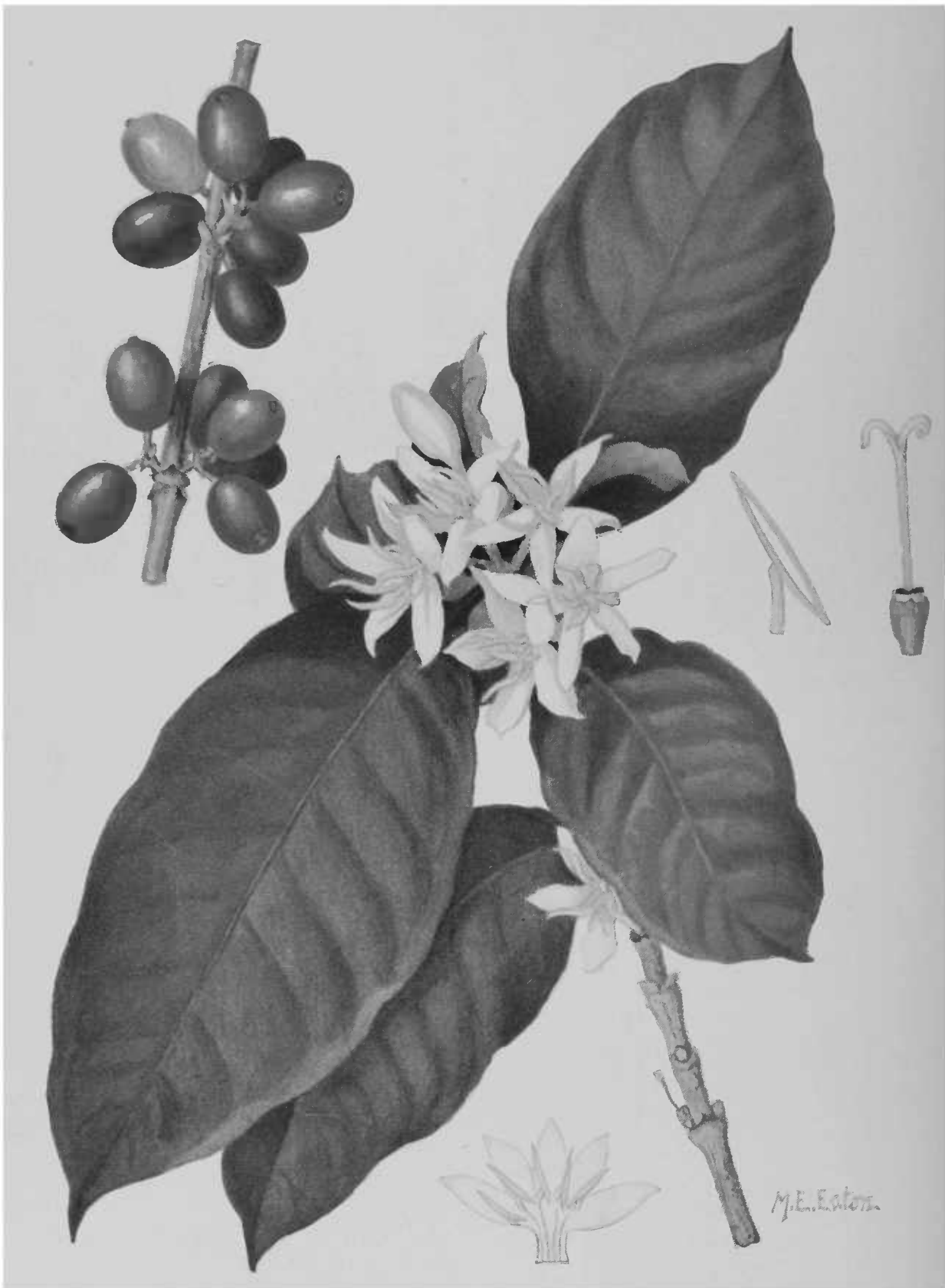
*Coffea arabica* we know best because of the important role it plays in commerce.

#### COMPLETE CLASSIFICATION OF COFFEE

Kingdom .....	Vegetable
Sub-Kingdom .....	Angiospermæ
Class .....	Dicotyledonæ
Sub-class .....	Sympetalæ or Metachlamydeæ
Order .....	Rubiales
Family .....	Rubiaceæ
Genus .....	Coffea
Sub-genus .....	Eucoffea
Species .....	<i>C. arabica</i>

The coffee plant most cultivated for its berries is, as already stated, *Coffea arabica*,





**COFFEE ARABICA; LEAVES, FLOWERS AND FRUIT**  
Painted from nature by M. E. Eaton—Detail sketches show anther, pistil, and section of corolla





SHOWING DIFFERENT STAGES IN THE GERMINATION OF COFFEE SEED

which is found in tropical regions, although it can grow in temperate climates. Unlike most plants that grow best in the tropics, it can stand low temperatures. It requires shade when it grows in hot, low-lying districts; but when it grows on elevated land, it thrives without such protection. Freeman<sup>1</sup> says there are about eight recognized species of *coffea*.

#### *Coffea Arabica*

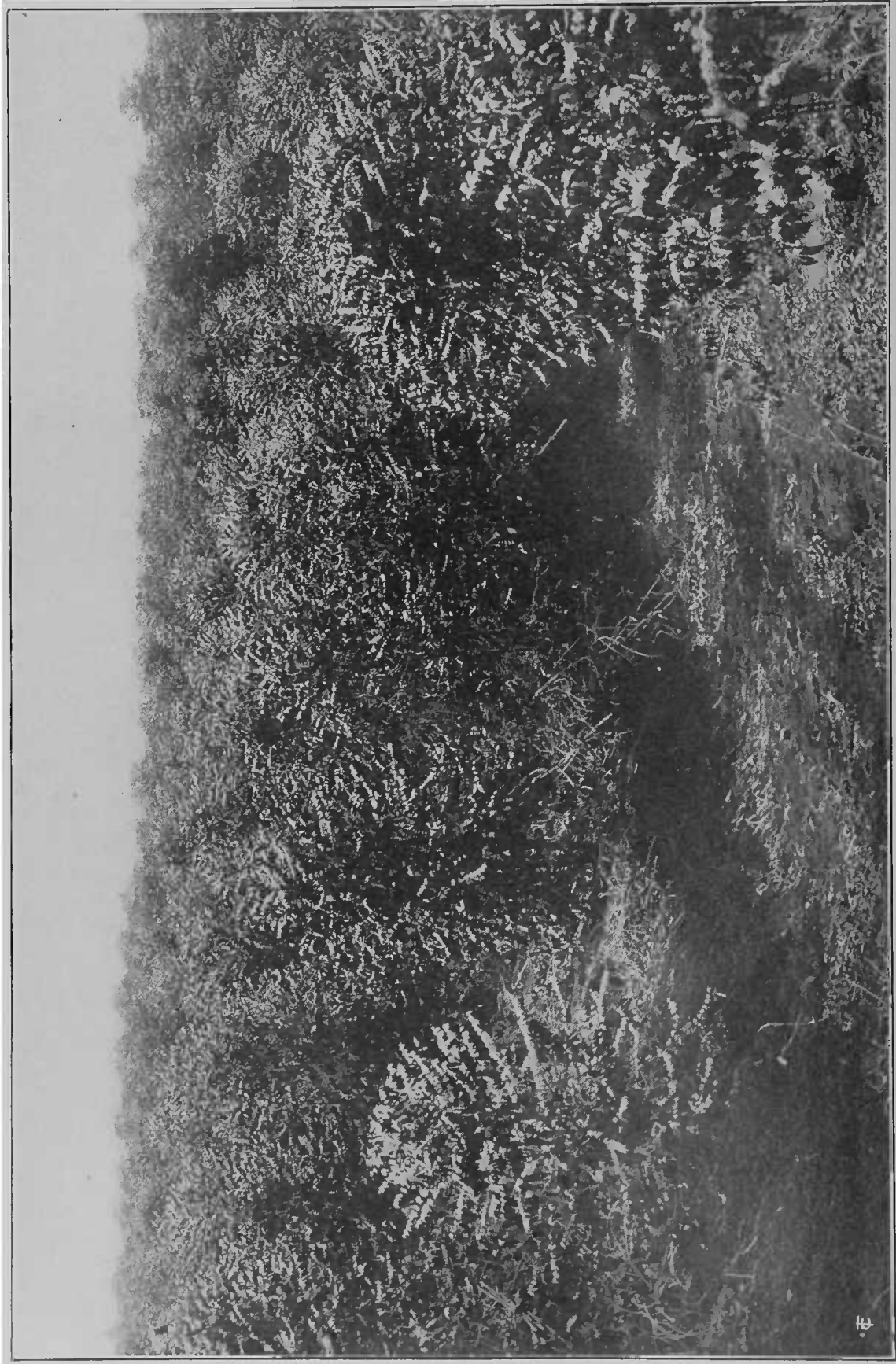
*Coffea arabica* is a shrub with evergreen leaves, and reaches a height of fourteen to twenty feet when fully grown. The shrub produces dimorphic branches, *i. e.*, branches of two forms, known as uprights and laterals. When young, the plants have a main stem, the upright, which, however, eventually sends out side shoots, the laterals. The laterals may send out other laterals, known as secondary laterals; but no lateral can ever produce an upright. The laterals are produced in pairs and are opposite, the pairs being borne in whorls around the stem. The laterals are produced only while the joint of the upright, to which they are attached, is young; and if they are broken off at that point, the

upright has no power to reproduce them. The upright can produce new uprights also; but if an upright is cut off, the laterals at that position tend to thicken up. This is very desirable, as the laterals produce the flowers, which seldom appear on the uprights. This fact is utilized in pruning the coffee tree, the uprights being cut back, the laterals then becoming more productive. Planters in some countries keep their trees pruned down to about six feet, while it is customary in other producing countries to let them grow to about twelve feet.

The leaves are lanceolate, or lance-shaped, being borne in pairs opposite each other. They are three to six inches in length, with an acuminate apex, somewhat attenuate at the base, with very short petioles which are united with the short interpetiolar stipules at the base. The coffee leaves are thin, but of firm texture, slightly coriaceous. They are very dark green on the upper surface, but much lighter underneath. The margin of the leaf is entire and wavy. In some tropical countries the natives brew a coffee tea from the leaves of the coffee tree.

The coffee flowers are small, white, and very fragrant, having a delicate characteristic odor. They are borne in the axils of the leaves in clusters, and several crops are

<sup>1</sup>Freeman, W. G. *The World's Commercial Products*. Boston. (p. 176.)



THE BEAUTY OF A COFFEE ESTATE IN FLOWER IS OF A VERY FLEETING CHARACTER

produced in one season, depending on the conditions of heat and moisture that prevail in the particular season. The different blossomings are classed as main blossoming and smaller blossomings. In semi-dry high districts, as in Costa Rica or Guatemala, there is one blossoming season, about March, and, as a rule, flowers and fruit are not found together on the trees. But in lowland plantations where rain is perennial, blooming and fruiting continue practically all the year; and ripe fruits, green fruits, open flowers, and flower buds are to be found at the same time on the same branchlet, not mixed together, but in the order indicated.

The flowers are also tubular, the tube of the corolla dividing into five white segments. Dr. P. J. S. Cramer, chief of the division of plant breeding, Department of Agriculture, Netherlands India, says the number of petals is not at all constant, not even for flowers of the same tree. The corolla segments are about one-half inch in length, while the tube itself is about three-eighths of an inch long. The anthers of the stamens, which are five in number, protrude from the top of the corolla tube, together with the top of the two-cleft pistil. The calyx, which is so small as to escape notice unless one is aware of its existence, is annular, with small, tooth-like indentations.

While the usual color of the coffee flower is white, the fresh stamens and pistils may have a greenish tinge, and in some cultivated species the corolla is pale pink.

The size and condition of the flowers are entirely dependent on the weather. The flowers are sometimes very small, very fragrant, and very numerous; while at other



C. ARABICA, FLOWER, AND FRUIT—COSTA RICA

times, when the weather is not hot and dry, they are very large, but not so numerous. Both sets of flowers mentioned above "set fruit," as it is called; but at times, especially in a very dry season, they bear flowers that are few in number, small, and imperfectly formed, the petals frequently being green instead of white. These flowers do not set fruit. The flowers that open on a dry sunny day show a greater yield of fruit than those that open on a wet day, as the first mentioned have a better chance of being pollinated by the insects and the wind. The beauty of a coffee estate in flower is of a very fleeting character. One day it is a snowy expanse of fragrant white blossoms for miles and miles, as far as the eye can see, and two days later it reminds one of the lines from Villon's *Des Dames du Temps Jadis*.

Where are the snows of yesterday?  
The winter winds have blown them all away.

But here, the winter winds are not to blame: the soft, gentle breezes of the perpetual summer have wrought the havoc, leaving, however, a not unpleasing picture of dark, cool, mossy green foliage.

The flowers are beautiful, but the eye of the planter sees in them not alone beauty

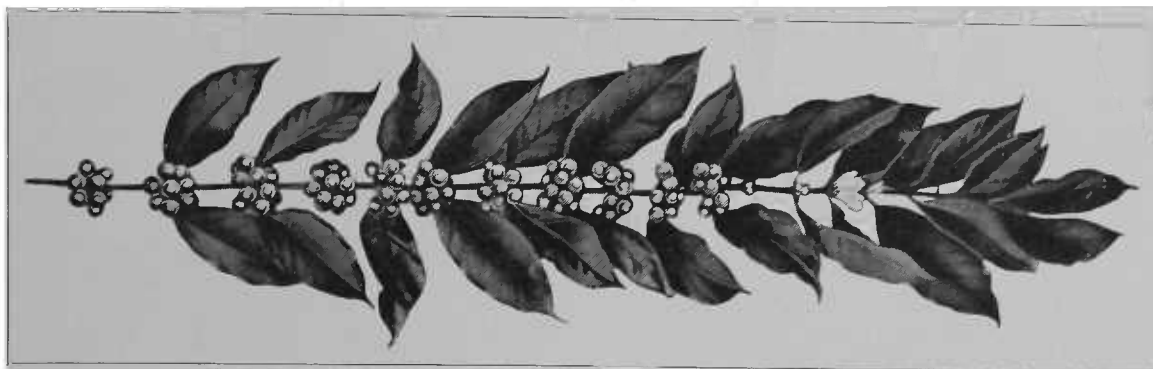


COFFEE ARABICA—PUERTO RICO



**COFFEA ARABICA IN FLOWER ON A JAVA ESTATE**

From a photograph made at Dramaga, Preanger, Java.



BRANCH OF COFFEE TREE, SHOWING LEAVES, BERRIES, AND FLOWERS, COSTA RICA

and fragrance. He looks far beyond, and in his mind's eye he sees bags and bags of green coffee, representing to him the goal and reward of all his toil. After the flowers droop, there appear what are commercially known as the coffee berries. Botanically speaking, "berry" is a misnomer. These little fruits are not berries, such as are well represented by the grape, but are drupes, which are better exemplified by the cherry and the peach. In the course of six or seven months, these coffee drupes develop into little red balls about the size of an ordinary cherry; but, instead of being round, they are somewhat ellipsoidal, having at the outer end a small umbilicus. The drupe of the coffee usually has two locules, each containing a little "stone" (the seed and its parchment covering) from which the coffee bean (seed) is obtained. Some few drupes contain three, while others, at the outer ends of the branches, contain only one round bean, known as the peaberry. The number of pickings corresponds to the different blossomings in the same season; and one tree of the species *arabica* may yield from one to twelve pounds a year.

In countries like India and Africa, the birds and monkeys eat the ripe coffee berries. The so-called "monkey coffee" of India, according to Arnold, is the undigested coffee beans passed through the alimentary canal of the animal.

The pulp surrounding the coffee beans is at present of no commercial importance. Although efforts have been made at various times by natives to use it as a food, its flavor has not gained any great popularity, and the birds are permitted a monopoly of the pulp as a food. From the human standpoint the pulp, or sarcocarp, as it is scientifically called, is rather an annoyance, as it must be removed in order to procure

the beans. This is done in one of two ways. The first is known as the dry method, in which the entire fruit is allowed to dry, and is then cracked open. The second way is called the wet method; in which the sarcocarp is removed by machine, and two wet, slimy seed packets are obtained. These packets, which look for all the world like seeds, are allowed to ferment and are then washed. This rids them of all the slime; and, after they are thoroughly dry, the endocarp, the so-called parchment covering, is easily cracked open and removed. At the same time that the parchment is removed, a thin silvery membrane, the silvery skin, beneath the parchment, comes off too. There are always small fragments of



COFFEE TREE IN BLOSSOM, KONA-SIDE, HAWAII





**A HEAVY FLOWERING OF FIVE-YEAR-OLD COFFEA EXCELSA**

This species was discovered in the Tchad Lake district of West Africa in 1905. It is a small-beaned variety of *Coffea liberica*



LIBERIAN COFFEE TREE AT LAMO, P. I.

this silver skin to be found in the groove of the coffee bean contained within the parchment packet.

We have said that the coffee tree yields from one to twelve pounds a year, but of course this varies with the individual tree and also with the region. In some countries the whole year's yield is less than 200 pounds per acre, while there is on record a patch in Brazil which yields about seventeen pounds to the tree, bringing the yield per acre much higher.

The beans do not retain their vitality for planting for any considerable length of time; and, if they are thoroughly dried, or are kept for longer than three or four months, they are useless for that purpose. It takes the seed about six weeks to germinate and to appear above ground. Trees raised from seed begin to blossom in about three years; but a good crop can not be expected of them for the first five or six years. Their usefulness, save in exceptional cases, is ended in about thirty years.

The coffee tree can be propagated in a way other than by seeds. The upright branches can be used as slips, which, after taking root, will produce seed-bearing laterals. The laterals themselves can not be used as slips. In Central America the natives sometimes use coffee uprights for

fences and it is no uncommon sight to see the fence posts "growing."

The wood of the coffee tree is used also for cabinet work, as it is much stronger than many of the native woods, weighing about forty-three pounds to the cubic foot, having a crushing strength of 5,800 pounds per square inch, and a breaking strength of 10,900 pounds per square inch.

The propagation of the coffee plant by cutting has two distinct advantages over propagation by seed, in that it spares the expense of seed production, which is enormous, and it gives also a method of hybridization, which, if used, might lead not only to very interesting but also to very profitable results.

The hybridization of the coffee plant was taken up in a thoroughly scientific manner by the Dutch government at the experimental garden established at Bangelan, Java, in 1900. In his studies, twelve varieties of *Coffea arabica* are recognized by Dr. P. J. S. Cramer, namely:

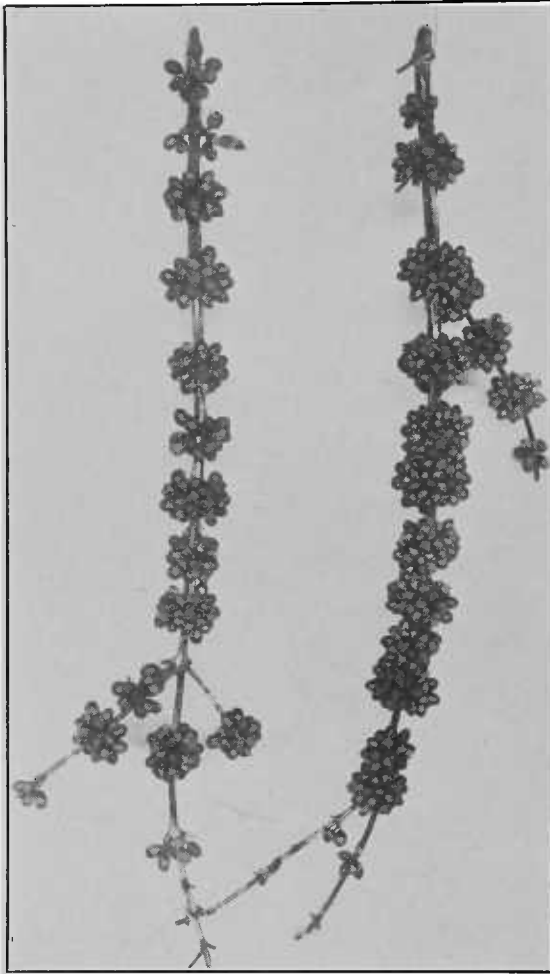
*Laurina*, a hybrid of *Coffea arabica* with *C. mauritiana*, having small narrow leaves, stiff, dense branches, young leaves almost white, berry long and narrow, and beans narrow and oblong.

*Murta*, having small leaves, dense branches, beans as in the typical *Coffea arabica*, and the plant able to stand bitter cold.

*Menosperma*, a distinct type, with narrow leaves and bent-down branches resembling a willow, the berries seldom containing more than one seed.



TWO-AND-ONE-HALF-YEAR-OLD *C. congensis*



BRANCHES OF *Coffea excelsa* GROWN AT THE LAMAO EXPERIMENT STATION, P. I.

*Mokka* (*Coffea moka*), having small leaves, dense foliage, small round berries, small round beans resembling split peas, and possessed of a stronger flavor than *Coffea arabica*.

*Purpurescens*, a red-leaved variety, comparable with the red-leaved hazel and copper beech, a little less productive than the *Coffea arabica*.

*Variegata*, having variegated leaves striped and spotted with white.

*Amarella*, having yellow berries, comparable with the white-fruited variety of the strawberry.

*Bullata*, having broad, curled leaves; stiff, thick, fragile branches, and round, fleshy berries containing many empty beans.

*Angustifolia*, a narrow-leaved variety, with berries somewhat more oblong and, like the foregoing, a poor producer.

*Erecta*, a variety that is sturdier than the typical *arabica*, better suited to windy places, and having a production as in the common *arabica*.

*Maragogipe*, a well-defined variety with light green leaves having colored edges; berries large, broad, often narrower in the middle; a light bearer; sometimes a few berries per tree.<sup>2</sup>

<sup>2</sup>Dr. Cramer considers *C. maragogipe* "the finest coffee known; it has a highly developed, splendid flavor."

*Columnaris*, a vigorous variety, sometimes reaching a height of 25 feet, having leaves rounded at the base and rather broad, but a shy bearer, recommended for dry climates.<sup>3</sup>

### *Coffea stenophylla*

*Coffea arabica* has a formidable rival in the species *stenophylla*. The flavor of this variety is pronounced by some as surpassing that of *arabica*. The great disadvantage of this plant is the fact that it requires so long a time before a yield of any value can be secured. Although the time required for the maturing of the crop is so long, when once the plantation begins to yield, the crop is as large as that of *Coffea arabica*, and occasionally somewhat larger. The leaves are smaller than any of the species described, and the flowers bear their parts in numbers varying from six to nine. The tree is a native of Sierra Leone, where it grows wild.

### *Coffea liberica*

The bean of *Coffea arabica*, although the principal bean used in commerce, is not the

<sup>3</sup>*Tea and Coffee Trade Journal*, Oct., 1918. (p. 321).



*Coffea arabica*'s FORMIDABLE RIVAL  
*C. stenophylla*, From which is obtained the highland coffee of Sierra Leone



WILD "CAFFEINE-FREE" COFFEE TREE  
Mantsaka or Caf  Sauvage—Madagascar

only one; and it may not be out of place here to describe briefly some of the other varieties that are produced commercially. *Coffea liberica* is one of these plants. The quality of the beverage made from its berries is inferior to that of *Coffea arabica*, but the plant itself offers distinct advantages in its hardy growing qualities. This makes it attractive for hybridization.

The *Coffea liberica* tree is much larger and sturdier than the *Coffea arabica*, and in its native haunts it reaches a height of 30 feet. It will grow in a much more torrid climate and can stand exposure to strong sunlight. The leaves are about twice as long as those of *arabica*, being six to twelve inches in length, and are very thick, tough, and leathery. The apex of the leaf is acute. The flowers are larger than those of *arabica*, and are borne in dense clusters. At any time during the season,

the same tree may bear flowers, white or pinkish and fragrant, or even green, together with fruits, some green, some ripe and of a brilliant red. The corolla has been known to have seven segments, though as a rule it has five. The fruits are large, round, and dull red; the pulps are not juicy, and are somewhat bitter. Unlike *Coffea arabica*, the ripened drupes do not fall from the trees, and so the picking can be delayed at the planter's convenience.

Among the allied Liberian species Dr. Cramer recognizes:

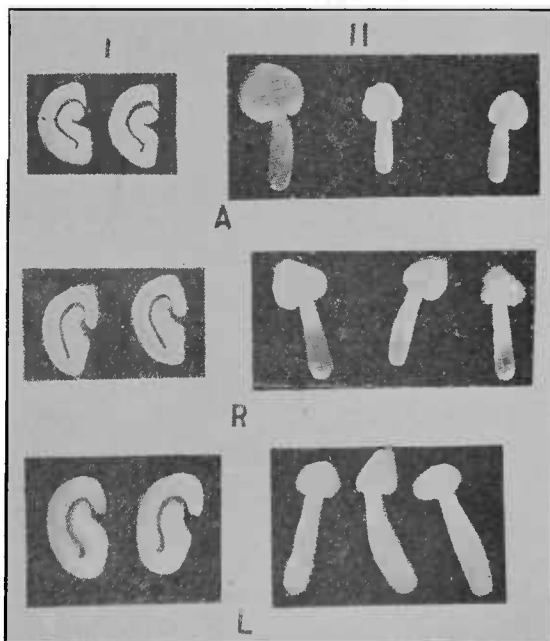
*Abeokutae*, having small leaves of a bright green, flower buds often pink just before opening (in Liberian coffee never), fruit smaller with sharply striped red and yellow shiny skin, and producing somewhat smaller beans than Liberian coffee, but beans whose flavor and taste are praised by brokers.

*Dewevrei*, having curled-edged leaves, stiff branches, thick-skinned berries, sometimes pink flowers, beans generally smaller than in *C. liberica*, but of little interest to the trade.

*Arnoldiana*, a species near to *Coffea abeokutae* having darker foliage and even-colored small berries.

*Laurentii gillet*, a species not to be confused with the *C. laurentii* belonging to the *robusta* coffee, but standing near to *C. liberica*, characterized by oblong rather than thin-skinned berries.

*Excelsa*, a vigorous, disease-resisting species discovered in 1905 by Aug. Chevalier in West Africa, in the region of the Chari River, not far from Lake Tchad. The broad, dark-green leaves



DIFFERENTIATING CHARACTERISTICS OF COFFEE BEANS, IN CROSS-SECTION

Col. I. Mature bean. Col. II. Embryo.  
A. *Coffea arabica*, R. *Coffea robusta*, L. *Coffea liberica*





COFFEA ARABICA BERRIES GROWN IN THE  
HAWAIIAN ISLANDS



have an under side of light green with a bluish tinge; the flowers are large and white, borne in axillary clusters of one to five; the berries are short and broad, in color crimson, the bean smaller than *robusta*, very like *mocha*, but in color a bright yellow like *liberica*. The caffeine content of the coffee is high, and the aroma is very pronounced.

*Dybowskii*, another disease-resisting variety similar to *excelsa*, but having different leaf and fruit characteristics.

*Lamboray*, having bent gutter-like leaves, and soft-skinned, oblong fruit.

*Wanni Rukula*, having large leaves, a vigorous growth, and small berries.

*Coffea aruwimensis*, being a mixture of different types.

The last three types were received by Dr. Cramer at Bangelan from Frère Gillet in the Belgian Congo.

### *Coffea Robusta*

Emil Laurent, in 1898, discovered a species of coffee growing wild in Congo. This was taken up by a horticultural firm of Brussels, and cultivated for the market. This firm gave to the coffee the name of *Coffea robusta*, although it had already been given the name of the discoverer, being known as *Coffea laurentii*. The plant differs widely from both *arabica* and *liberica*,

being considerably larger than either. The tree is umbrella-shaped, due to the fact that its branches are very long and bend toward the ground.

The leaves of *robusta* are much thinner than those of *liberica*, though not as thin as those of *arabica*. The tree, as a whole, is a very hardy variety and even bears blossoms when it is less than a year old. It blossoms throughout the entire year, the flowers having six-parted corollas. The drupes are smaller than those of *liberica*, but are much thinner skinned, so that the coffee bean is actually not any smaller. The drupes mature in ten months. Although the plants bear as early as the first year, the yield for the first two years is of no account, but by the fourth year the crop is large.

Arno Viehoever, pharmacognosist in charge of the pharmacognosy laboratory of the Bureau of Chemistry, United States Department of Agriculture, in 1921, announced certain findings confirming Hartwich which appear to permit of differentiation between *robusta*, *arabica*, and *liberica*. These are mainly the peculiar folding of the endosperm, showing quite generally a distinct hook in the case of the *robusta* coffee bean. The size of the embryo, and es-



ROBUSTA COFFEE IN FLOWER, PREANGER, JAVA



ONE-YEAR-OLD ROBUSTA ESTATE, ON SUMATRA'S WEST COAST

pecially the relation of the rootlet to hypercotyl, will be found useful in the differentiation of the species *Coffea arabica*, *liberica*, and *robusta* (see cut, page 279).

Viehoever and Lepper carried on a series of cup tests of *robusta*, the results as to taste and flavor being distinctly favorable.<sup>4</sup> They summarized their studies and tests as follows:

The time when coffee could be limited to beans obtained from plants of *Coffea arabica* and *Coffea liberica* has passed. Other species, with qualities which make them desirable, even in preference to the well reputed named ones, have been discovered and cultivated. Among them, the species or group of *Coffea robusta* has attained a great economic significance, and is grown in increasing amounts. While it has, as reports seem to indicate, not as yet been possible to obtain a strain that would be as desirable in flavor as the old "standard" *Coffea arabica*, well known as Java or "Fancy Java" coffee, its merits have been established.

The botanical origin is not quite cleared up, and the classification of the varieties belonging to the *robusta* group deserves further study. Anatomical means of differentiating *robusta* coffee from other species or groups, may be applied as distinctly helpful.

As is usual in most of the coffee species, caffeine is present. The amount appears to be, on an average, somewhat larger (even exceeding

2.0 percent) than in the South American coffee species. In no instance, however, did the amount exceed the maximum limits observed in coffee in general.

Due to its rapid growth, early and prolific yield, resistance to coffee blight, and many other desirable qualities, *Coffea robusta* has established "its own." In the writers' judgment, *robusta* coffee deserves consideration and recognition.

Among the *robusta* varieties, *Coffea canephora* is a distinct species, well characterized by growth, leaves, and berries. The branches are slender and thinner than *robusta*; the leaves are dark green and narrower; the flowers are often tinged with red; the unripe berries are purple, the ripe berries bright red and oblong. The produce is like *robusta*, only the shape of the bean, somewhat narrower and more oblong, makes it look more attractive. *Coffea canephora*, like *C. robusta*, seems better fitted to higher altitudes.

Other *canephora* varieties include:

*Madagascar*, having small, slightly striped, bright red berries and small round beans;

*Quillouensis*, having dark green foliage and redish brown young leaves; and,

*Stenophylla Paris*, with purplish young berries.

Among other allied *robusta* species are:

<sup>4</sup> *Journal of the Association of Official Agricultural Chemists*, Nov. 15, 1921. (vol. v: no. 2: pp. 274-288.)

*Ugandæ*, whose produce is said to possess a better flavor than *robusta*;

*Bukobensis*, different from *ugandæ* in the color of its berries, which are a dark red; and

*Quillou*, having bright red fruit, a copper-colored silver skin, three pounds of fruit producing one pound of market coffee. Some people prefer *quillou* to *robusta* because of the difference in the taste of the roasted bean.

#### Some Interesting Hybrids

The most popular hybrid belongs to a crossing of *liberica* and *arabica*. Cramer states that the beans of this hybrid make an excellent coffee combining the strong taste of the *liberica* with the fine flavor of the old Government Java (*arabica*), adding:

The hybrids are not only of value to the roaster, but also to the planter. They are vigorous trees, practically free from leaf disease; they stand drought well and also heavy rains; they are not particular in regard to shade and upkeep; never fail to give a fair and often a rather heavy crop. The fruit ripens all the year around, and does not fall so easily as in the case of *arabica*.

Among other hybrids, may be mentioned: *Coffea excelsa x liberica*; *C. abeokutæ x*

*liberica*; *C. dybowski x excelsa*; *C. stenophylla x abeokutæ*; *C. congensis x ugandæ*; *C. ugandæ x congensis*; and *C. robusta x maragogipe*.

There are many species of *Coffea* that stand quite apart from the main groups, *arabica*, *robusta* and *liberica*; but while some are of commercial value, most of them are interesting only from the scientific point of view. Among the latter may be mentioned: *Coffea bengalensis*, *C. perieri*, *C. mauritiana*, *C. macrocarpa*, *C. madagascariensis*, and *C. schumanniana*.

M. Teyssonier, of the experimental garden at Camayenne, French Guinea, West Africa, has produced a promising species of coffee known as *affinis*. It is a hybrid of *C. stenophylla* with a species of *liberica*.

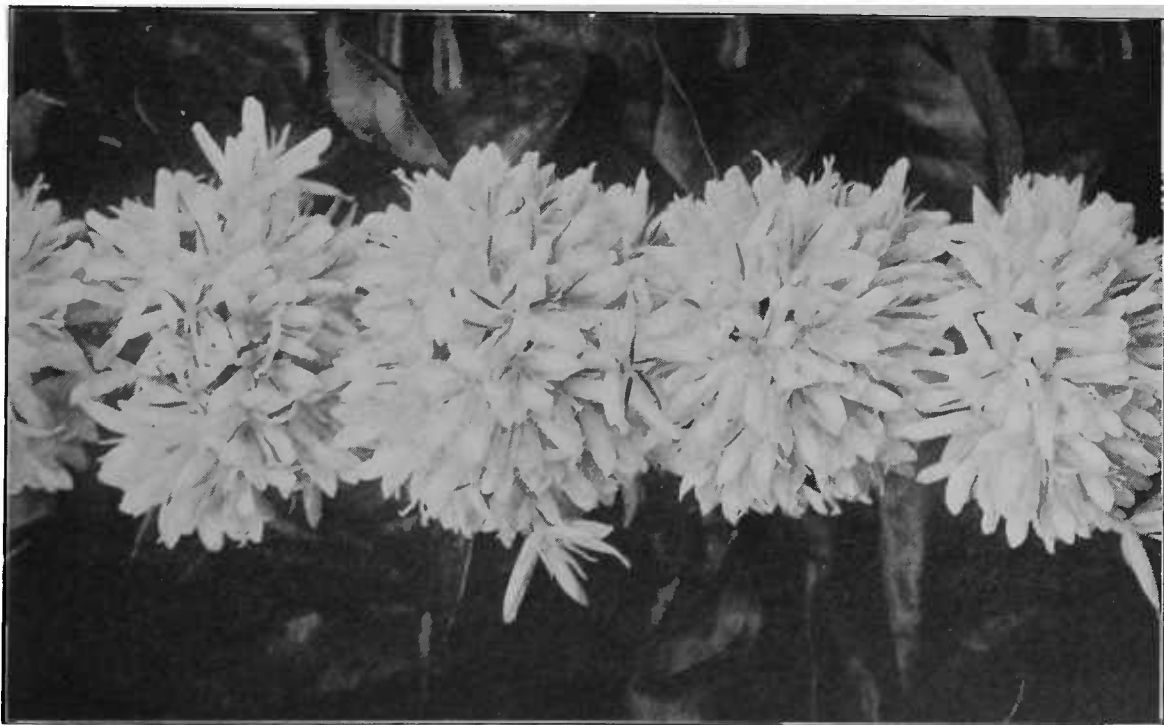
Among other promising species recognized by Dr. Cramer are:

*Coffea congensis*, whose berry resembles that of *C. arabica*, when well prepared for the market being green or bluish; and

*Coffea congensis* var. *chalotii*, probably a hybrid of *C. congensis* with *C. canephora*.

#### Caffeine-free Coffee

Certain trees growing wild in the Comoro Islands and Madagascar are known as caffeine-free coffee trees. Just whether they



*Coffea quillou* FLOWERS IN FULL BLOOM

are entitled to this classification or not is a question. Some of the French and German investigators have reported coffee from these regions that was absolutely devoid of caffeine. It was thought at first that they must represent an entirely new genus; but upon investigation, it was found that they belonged to the genus *Coffea*, to which all our common coffees belong. Professor Dubard, of the French National Museum and Colonial Garden, studied these trees botanically and classified them as *C. gallienii*, *C. bonnierii*, *C. mogeneti*, and *C. augagneuri*. The beans of berries from these trees were analyzed by Professor Bertrand and pronounced caffeine-free; but Labroy, in writing of the same coffee, states that, while the bean is caffeine-free, it contains a very bitter substance, cafamarine, which makes the infusion unfit for use. Dr. O. W. Willecox, in examining some specimens of wild coffee from Madagascar, found that the bean was not caffeine-free; and though the caffeine content was low, it was no lower than in some of the Puerto Rican varieties.<sup>5</sup>

Hartwich reports that Hanausek found no caffeine in *C. mauritiana*, *C. humboldtiana*, *C. gallienii*, *C. bonnierii*, and *C. mogeneti*.<sup>6</sup>

<sup>5</sup> *The Tea and Coffee Trade Journal*, Sept., 1912. (p. 231.)

<sup>6</sup> *Die Menschlichen Genussmittel*, 1911. (p. 300.)

#### *Fungoid Disease of Coffee*

The coffee tree, like every other living thing, has specific diseases and enemies, the most common of which are certain fungoid diseases where the mycelium of the fungus grows into the tissue and spots the leaves, eventually causing them to fall, thus robbing the plant of its only means of elaborating food. Its most deadly enemy in the insect world is a small insect of the lepidopterous variety, which is known as the coffee-leaf miner. It is closely related to the clothes moth and, like the moth, bores in its larval stage, feeding on the mesophyll of the leaves. This gives the leaves an appearance of being shriveled or dried by heat.

There are three principal diseases, due to fungi, from which the coffee plants suffer. The most common is known as the leaf-blight fungus, *Pellicularia tokeroga*, which is a slow-spreading disease, but one that causes great loss. Although the fungus does not produce spores, the leaves die and dry, and are blown away, carrying with them the dried mycelium of the fungus. This mycelium will start to grow as soon as it is supplied with a new moist coffee leaf to nourish it. The method of getting rid of this disease is to spray the trees in seasons of drought.

It was a fungoid disease known as the



AN EIGHTEEN-MONTHS'-OLD *Coffea quillou* TREE IN BLOSSOM

*Hemileia vastatrix* that attacked Ceylon's coffee industry in 1869, and eventually destroyed it. It is a microscopic fungus whose spores, carried by the wind, adhere to and germinate upon the leaves of the coffee tree.<sup>7</sup>

Another common disease is known as the root disease, which eventually kills the tree by girdling it below the soil. It spreads slowly, but seems to be favored by collections of decaying matter around the base of the tree. Sometimes the digging of ditches around the roots is sufficient to prevent the mycelium of the disease from reaching them. The other common disease is due to *Stilbium flavidum*, and is found only in regions of great humidity. It affects both the leaf and the fruit and is known as the spot of leaf and fruit.

<sup>7</sup> See chapter XXIII.

#### *Coffee Its Own Substitute*

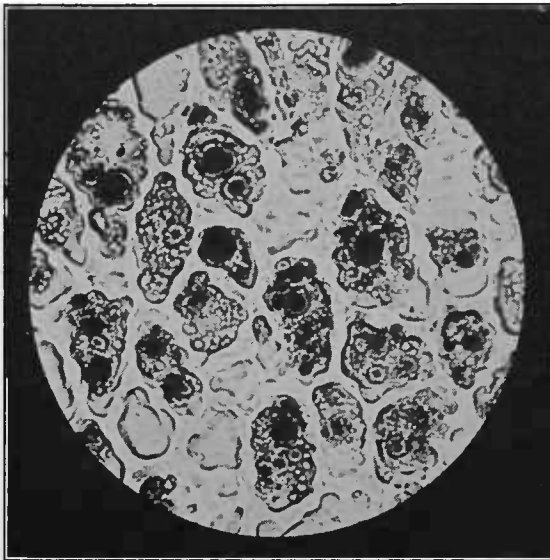
A widespread use of an infusion from leaves of the coffee plant, instead of the customary method of preparing coffee, has been reported in Java and Germany, and, in analyzing the results, the London *Pharmaceutical Journal* says that it makes a very nutritious drink:

The fact that caffeine exists in the leaves of the coffee plant has long been known, but it is only since the war that they have been commercially exploited to produce this drug. The idea originated in Sumatra, where under the present system of cultivation coffee is frequently attacked by insects of the genus *Coccus*. With the failure of the berry crop, the growers, seeking a substitute for the ordinary caffeine-containing product, collected the leaves, from which pure caffeine was prepared. With the war the demand for caffeine so greatly expanded that the process of extracting it from the leaves was resorted to on an extensive scale by Dutch factories, which purchased them by the ton.

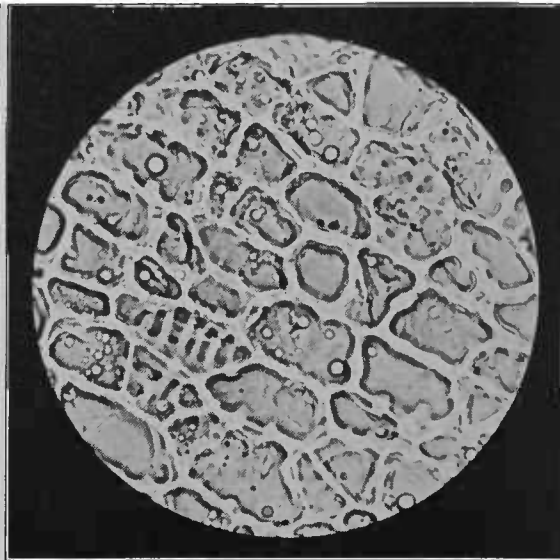


*Coffea ugandæ* BENT OVER BY A HEAVY CROP

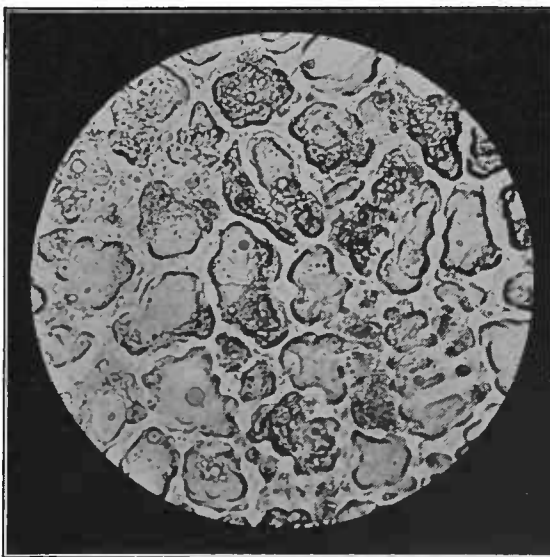




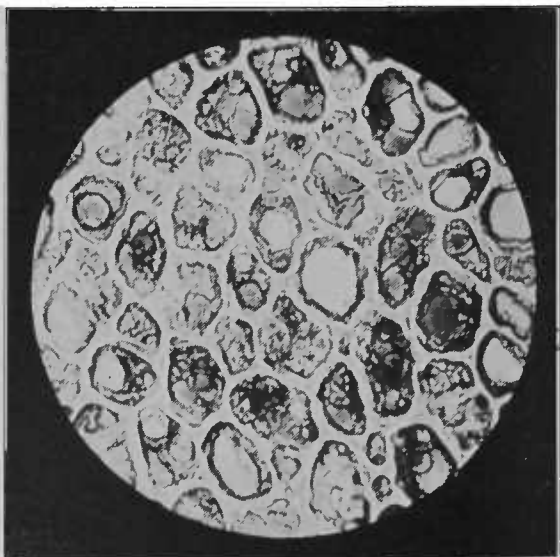
**BOGOTA, GREEN**  
Longitudinal—Magnified 200 diameters



**BOGOTA, GREEN**  
Cross Section—Magnified 200 diameters



**BOGOTA, GREEN**  
Tangential—Magnified 200 diameters



**BOGOTA, ROASTED**  
Tangential—Magnified 200 diameters

### GREEN AND ROASTED BOGOTA COFFEE UNDER THE MICROSCOPE

These pictures serve to demonstrate that the coffee bean is made up of minute cells that are not broken down to any extent by the roasting process. Note that the oil globules are more prominent in the green than in the roasted product

## CHAPTER XXIII

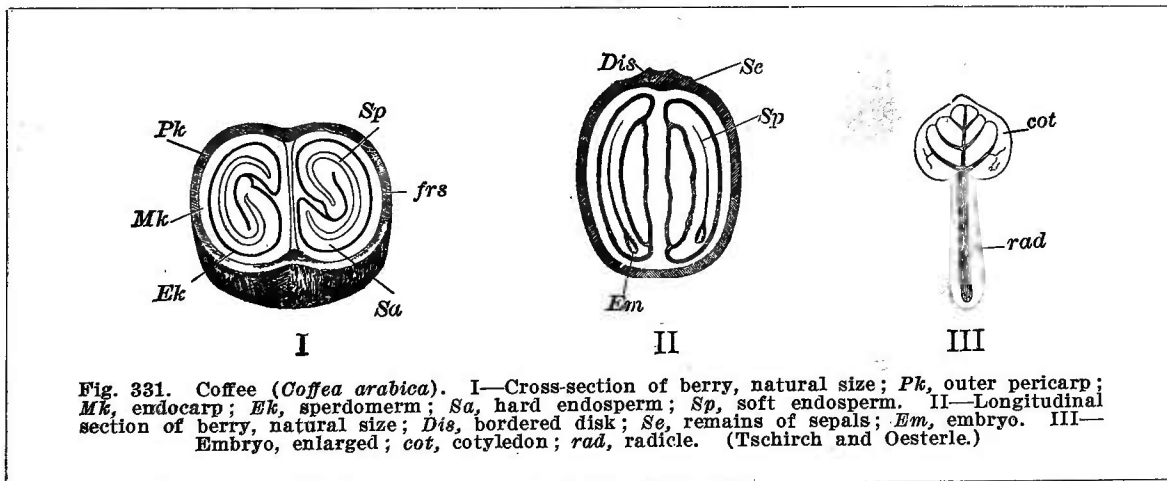
### THE MICROSCOPY OF THE COFFEE FRUIT

HOW THE BEANS MAY BE EXAMINED UNDER THE MICROSCOPE, AND WHAT IS REVEALED—STRUCTURE OF THE BERRY, THE GREEN, AND THE ROASTED BEAN—THE COFFEE LEAF DISEASE UNDER THE MICROSCOPE—VALUE OF MICROSCOPIC ANALYSIS IN DETECTING ADULTERATION

**T**HE microscopy of coffee is, on the whole, more important to the planter than to the consumer and the dealer; while, on the other hand, the microscopy is of paramount importance to the consumer and the dealer as furnishing the best means of determining whether the product offered is adulterated or not. Also, from this

spherical; in the rare instances where three seeds are found, the grains are angular.

The coffee bean with which the consumer is familiar is only a small part of the fruit. The fruit, which is the size of a small cherry, has, like the cherry, an outer fleshy portion called the pericarp. Beneath this is a part like tissue paper, spoken of technic-



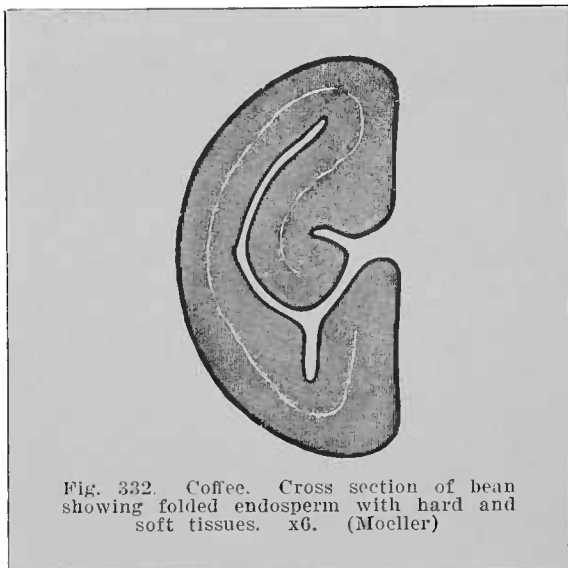
standpoint, the microscopy of the plant is less important than that of the bean.

#### *The Fruit and the Bean*

The fruit, as stated in chapter XXII, consists of two parts, each one containing a single seed, or bean. These beans are flattened laterally, so as to fit together, except in the following instances: in the peaberry, where one of the ovules never develops, the single ovule, having no pressure upon it, is

ally as the parchment, but known scientifically as the endocarp. Next in position to this, and covering the seed, is the so-called spermoderm, which means the seed skin, referred to in the trade as the silver skin. Small portions of this silver skin are always to be found in the cleft of the coffee bean.

The coffee bean is the embryo and its food supply; the embryo is that part of the seed which, when supplied with food and moisture, develops into a new plant. The embryo of the coffee is very minute (Fig.



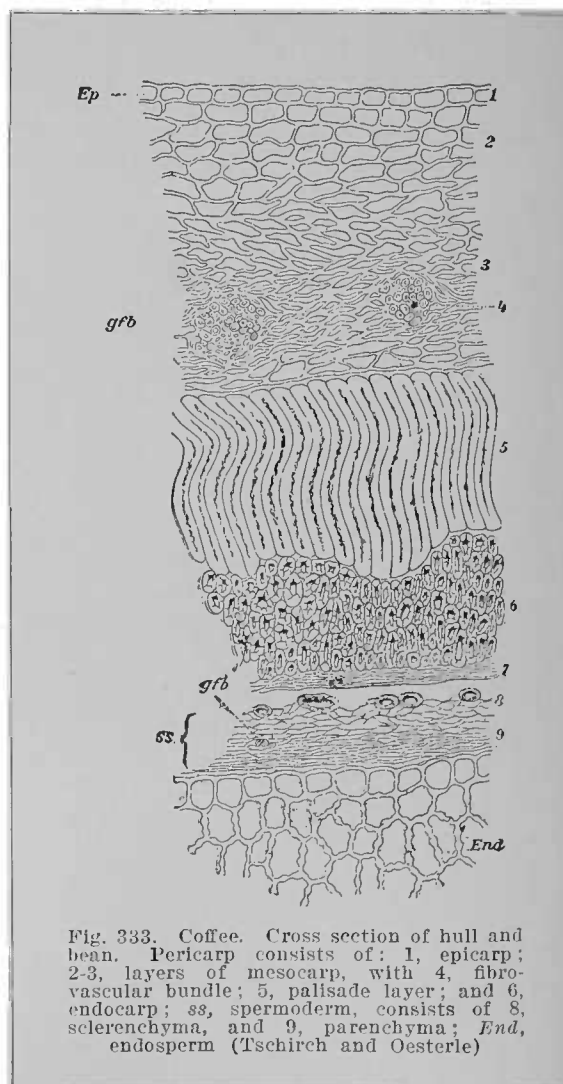
331, II, *Em*);<sup>1</sup> and the greater part of the seed is taken up by the food supply, consisting of hard and soft endosperm (Fig. 331, I and II, *Sa*, *Sp*). The minute embryo consists of two small thick leaves, the cotyledons (Fig. 331, III, *cot*), a short stem, invisible in the undissected embryo, and a small root, the radicle (Fig. 331, III, *rad*).

#### Fruit Structure

In order to examine the structure of these layers of the fruit under the microscope, it is necessary to use the pericarp dry, as it is not easily obtainable in its natural condition. If desired, an alcoholic specimen may be used, but it has been found that the dry method gives more satisfactory results. The dried pericarp is about 0.5 mm thick. Great difficulty is experienced in cutting microtome sections of pericarp when the specimen is embedded in paraffin, because the outer layers are soft and the endocarp is hard, and the two parts of the section separate at this point. To overcome this, the sections might also be embedded in celloidin. When the sections are satisfactory, they may be stained with any of the double stains ordinarily used in the study of plant histology.

A section cut crosswise through the entire fruit would present the appearance shown in Fig. 333. The cells of the epicarp are broad and polygonal, sometimes regu-

larly four-sided, about 15-35  $\mu$  broad. At intervals along the surface of the epicarp are stomata, or breathing pores, surrounded by guard cells. The next layer of the pericarp is the mesocarp (Figs. 333, 334, 335), the cells of which are larger and more regular in outline than the epicarp. The cells of the mesocarp become as large as 100  $\mu$  broad, but in the inner parts of the layer they become very much flattened. Fibrovascular bundles are scattered through the compressed cells of the mesocarp. The cell walls are thick; and large, amorphous, brown masses are found within the cell; occasionally, large crystals are found in the outer part of the layer. The fibrovascular bundles consist mainly of bast and wood fibres and vessels. The bast fibers are as large as 1 mm long and 25  $\mu$  broad, with thick walls and very small *lumina*. Spiral and pitted vessels are also present.



<sup>1</sup>These and all other numbered drawings in this chapter are from Andrew L. Winton's *The Microscopy of Vegetable Foods*, copyright 1916, and reprinted by permission.

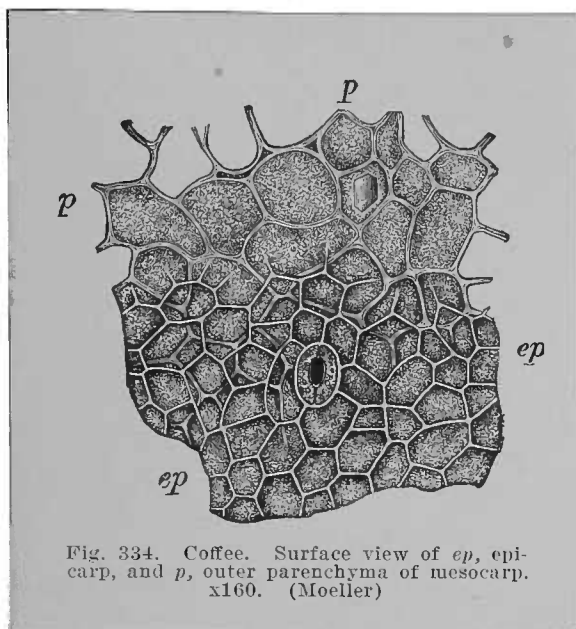


Fig. 334. Coffee. Surface view of *ep*, epicarp, and *p*, outer parenchyma of mesocarp.  $\times 160$ . (Moeller)

The layer next to this is a soft tissue, parenchyma (Fig. 333, 5; Fig. 334, *p*.) The parenchyma, or palisade cells as they are called, is a thin-walled tissue in which the cells are elongated, from which fact they receive their name. The walls of these cells, though very thin, are mucilaginous, and capable of taking up large amounts of water. They stain well with the aniline stains.

The endocarp (Fig. 336) is closely connected with the palisade layer and has thin-walled cells that closely resemble, in all respects, the endocarp of the apple. The outer layer consists of thick-walled fibers, which are remarkably porous (Fig. 333, 6; Fig. 336) while the fibers of the inner layer are thin-walled and run in the transverse direction.

#### The Bean Structure

Spermoderm, or silver skin, is not difficult to secure for microscopic analysis; because shreds of it remain in the groove of the berry, and these shreds are ample for examination. It can readily be removed without tearing, if soaked in water for a few hours. The spermoderm is thin enough not to need sectioning. It consists of two elements—sclerenchyma and parenchyma cells. (Figs. 333, 337, *st. p*).

Sclerenchyma forms an uninterrupted covering in the early stages of the seed; but as the seed develops, surrounding tissues grow more rapidly than the sclerenchyma,

and the cells are pushed apart and scattered. The cells occurring in the cleft of the berry are straight, narrow, and long, becoming as long as 1 mm, and resemble bast fibers somewhat. On the surface of the berry, and sometimes in the cleft, there are found smaller, thicker cells, which are irregular in outline, club-shaped and vermiform types predominating.

Parenchyma cells form the remainder of the spermoderm; and these are partially obliterated, so that the structure is not easily seen, appearing almost like a solid membrane. The raphe runs through the parenchyma found in the cleft of the berry.

The endosperm (Figs. 333, 338) consist of small cells in the outer part, and large cells, frequently as thick as  $100 \mu$ , in the inner part. The cell walls are thickened and knotted. Certain of the inner cells have mucilaginous walls which when treated with water disappear, leaving only the middle lamellae, which gives the section a peculiar appearance. The cells contain no starch, the reserve food supply being stored cellulose, protein, and aleurone grains. Various investigators report the presence of sugar, tannin, iron, salts, and caffeine.

The embryo (Fig. 331, III) may be obtained by soaking the bean in water for several hours, cutting through the cleft and carefully breaking apart the endosperm. If it is now soaked in diluted alkali, the embryo protrudes through the lower end of the endosperm. It is then cleared in alkali,

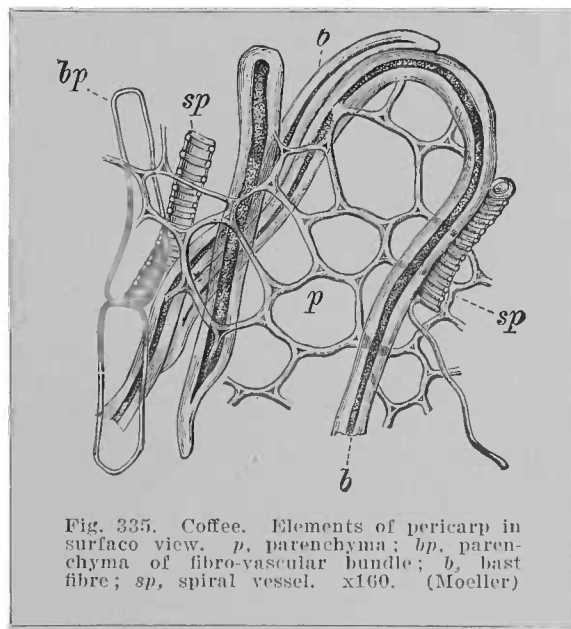


Fig. 335. Coffee. Elements of pericarp in surface view. *p*, parenchyma; *bp*, parenchyma of fibro-vascular bundle; *b*, bast fibre; *sp*, spiral vessel.  $\times 160$ . (Moeller)

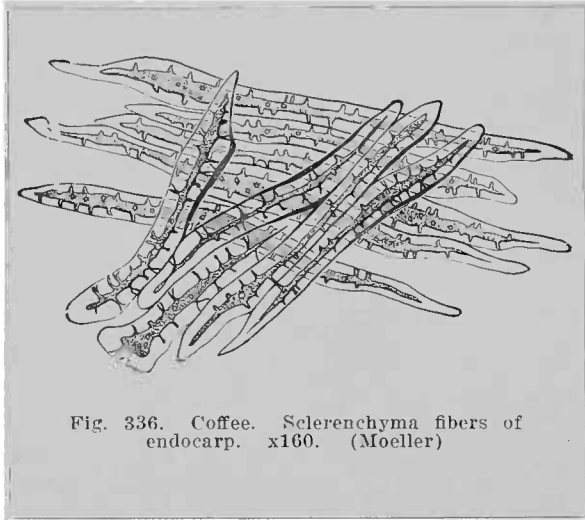


Fig. 336. Coffee. Sclerenchyma fibers of endocarp. x160. (Moeller)

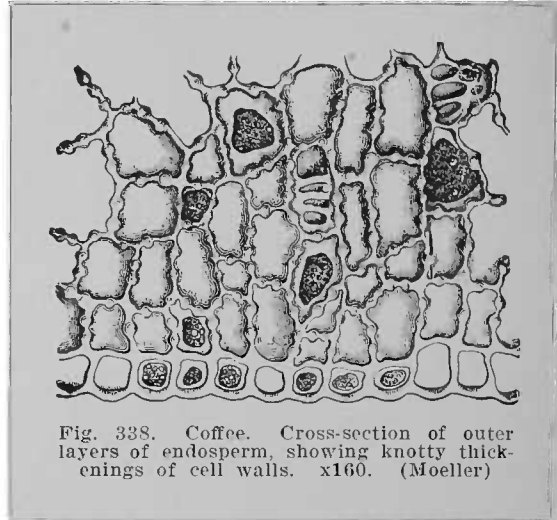


Fig. 338. Coffee. Cross-section of outer layers of endosperm, showing knotty thickenings of cell walls. x160. (Moeller)

or in chloral hydrate. The cotyledons shown have three pairs of veins, which are slightly netted. The radicle is blunt and is about  $\frac{3}{4}$  mm in length, while the cotyledons are  $\frac{1}{2}$  mm long.

#### The Coffee-Leaf Disease

The coffee tree has many pests and diseases; but the disease most feared by planters is that generally referred to as the coffee-leaf disease, and by this is meant the fungoid *Hemileia vastatrix*, which as told in chapter XV, destroyed Ceylon's once pros-

perous coffee industry. As it has since been found in nearly all coffee-producing countries, it has become a nightmare in the dreams of all coffee planters. The microscope shows how the spores of this dreaded

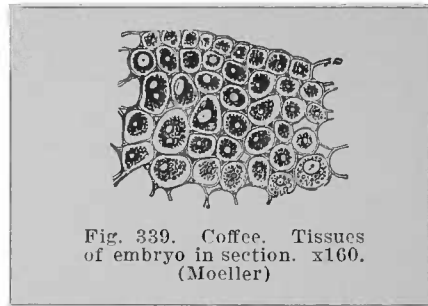


Fig. 339. Coffee. Tissues of embryo in section. x160. (Moeller)

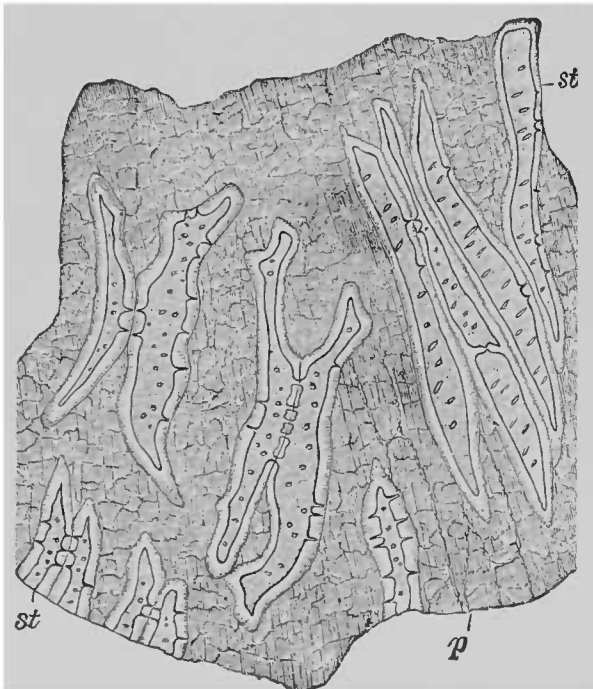


Fig. 337. Coffee. Spermoderm in surface view. *st.* sclerenchyma; *p.* compressed parenchyma. x160. (Moeller)

fungus, carried by the winds upon a leaf of the coffee tree, proceed to germinate at the expense of the leaf; robbing it of its nourishment, and causing it to droop and to die. A mixture of powdered lime and sulphur has been found to be an effective germicide, if used in time and diligently applied.

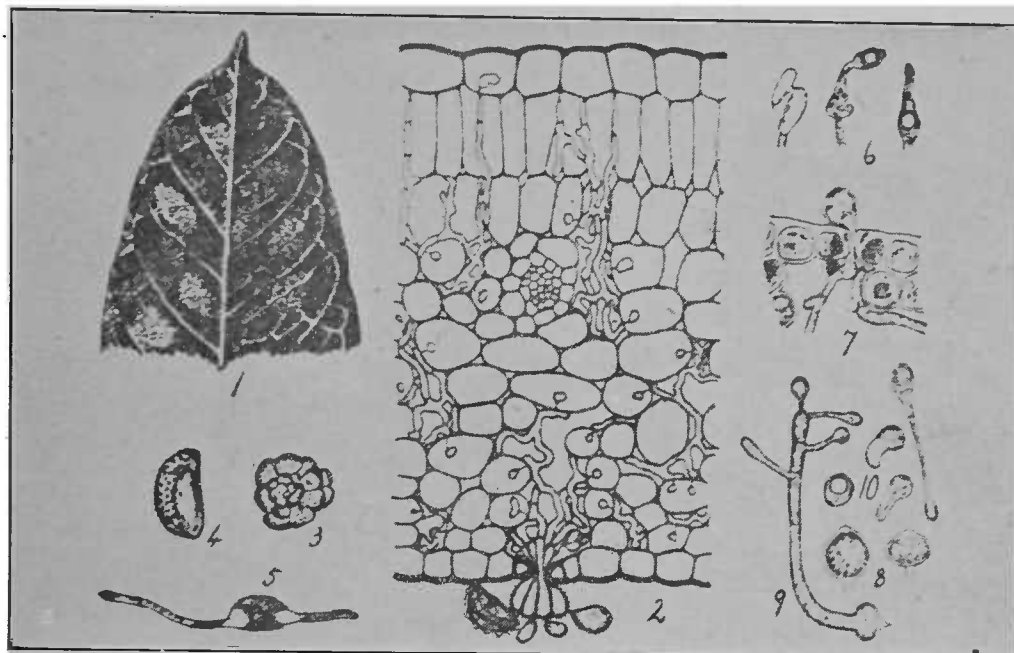
#### Value of Microscopic Analysis

The value of the microscopic analysis of coffee may not be apparent at first sight; but when one realizes that in many cases the microscopic examination is the only way to detect adulteration in coffee, its importance at once becomes apparent. In many instances the chemical analysis fails to get at the root of the trouble, and then the only method to which the tester has recourse is the examination of the suspected material under the scope. The mixing of chicory



with coffee has in the past been one of the commonest forms of adulteration. The microscopic examination in this connection

Roasted date stones have been used as adulterants, and these can be detected quite readily with the aid of the microscope, as



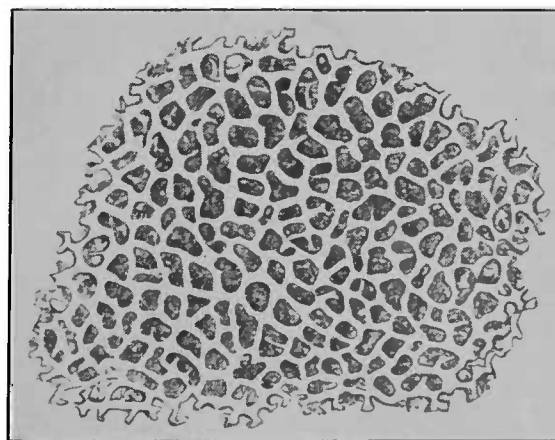
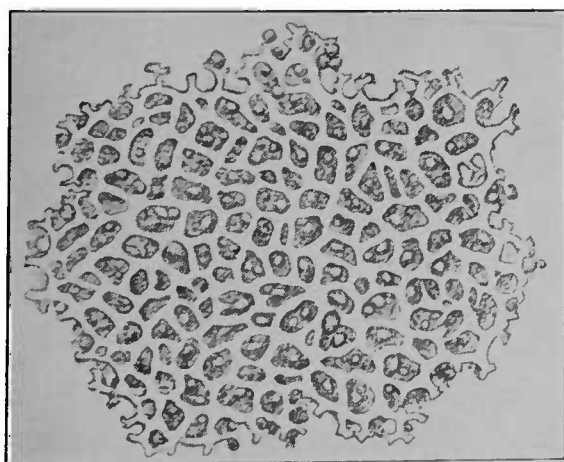
COFFEE LEAF DISEASE (*HEMILEIA VASTATRIX*)

1, under surface of affected leaf, x 1/2; 2, section through same showing mycelium, haustoria, and a spore-cluster; 3, a spore-cluster seen from below; 4, a uredospore; 5, germinating uredospore; 6, appressorial swellings at tips of germ-tubes; 7, infection through stoma of leaf; 8, teliospores; 9, teliospore germinating with promycelium and sporidia; 10, sporidia and their germination (2 after Zimmermann, 3 after Delacroix, 4-10 after Ward).

is the most reliable. The coffee grain will have the appearance already described. Microscopically, chicory shows numerous thin-walled parenchymatous cells, lactiferous vessels, and sieve tubes with transverse plates. There are also present large vessels with huge, well-defined pits.

they have a very characteristic microscopic appearance. The epidermal cells are almost oblong, while the parenchymatous cells are large, irregular and contain large quantities of tannin.

Adulteration and adulterants are considered more fully in another chapter.



GREEN AND ROASTED COFFEE UNDER THE MICROSCOPE

Green bean, showing the size and form of the cells as well as the drops of oil contained within their cavities. Drawn with the camera lucida, and magnified 140 diameters.

A fragment of roasted coffee under the microscope. Drawn with the camera lucida, and magnified 140 diameters.

## CHAPTER XXIV

# THE CHEMISTRY OF THE COFFEE BEAN

THE REASON FOR CHEMICAL COMPLEXITY OF SEEDS—COFFEE SEED IS NO EXCEPTION—ITS ORGANIC AND INORGANIC INGREDIENTS—COMPARATIVE ANALYSES—FATS AND OILS IN THE BEAN—CHEMICAL KNOWLEDGE OF COFFEE FRAGMENTARY—CHANGES CAUSED BY ROASTING—CAFFEINE THE MOST CHARACTERISTIC CONSTITUENT—CAFFEINE COMPLEXES IN THE BEAN—CAFFEINE DETERMINATIONS—THE AROMATIC PRINCIPLES—ALSO AN APPENDED REPORT BY DR. PUNNETT ON RECENT SCIENTIFIC INVESTIGATION OF COFFEE PROBLEMS

By DR. S. C. PRESCOTT

Dean of Science and Head of the Department of Biology and Public Health, Massachusetts Institute of Technology, Cambridge, Mass.

THE seeds of many types of flowering plants are not only intricate in structure but have a chemical composition of extreme complexity. They contain a large number of chemical substances which are developed during the process of growth and ripening, and which supply all the essential requirements, with the exception of water and oxygen, for healthy development into a young and vigorous plant. The coffee seed or "bean" is no exception to this rule, but it is impossible to give a complete or satisfactory account of its chemistry. Examination shows that it is characterized by a wide array of chemical ingredients, many of which are unidentified, and the part played by some of these in the nutrition of the sprouting seed and its later development is at present unknown.

As in other seeds, these chemical substances are in part inorganic in character, but by far the preponderating amount are organic. On the inorganic side, as determined by the examination of the ash there is considerable variation, brought about, no doubt, by differences in soil, climate, and other factors which affect the growth of the plant. Similarly, there are considerable variations in the organic constituents, influenced probably by the same factors as well as by the age, health or

vigor of the plant. In general, however, the broad composition of the coffee bean may be represented approximately by the analyses of four specimens of coffee from four different coffee-growing countries, as shown in the table on page 293.

Obviously, as in all food analyses, these figures give us only the great groups of substances entering into the composition of the seed, and, except possibly in the case of caffeine, do not supply information on the particular and highly specialized units which fall in each group. Other analyses, made by numerous workers of several countries are in substantial agreement.

The ash, which represents the inorganic or mineral ingredients of the seed, is a mixture of many salts. Some of these have undoubtedly a special function in the process of embryo-formation and the chemical changes accompanying germination, while others are likely to represent mineral ingredients occurring in the soil on which the parent plant grew, and which was brought by the flowing sap into the tissues of the rapidly developing ovule along with nutrient materials. It can readily be assumed that for a single species of plant certain salts are essential, but it may also be assumed that these are subject to considerable variation and also to the accompaniment of other possibly entirely super-

COMPARATIVE ANALYSES OF COFFEES FROM FOUR  
DIFFERENT COUNTRIES\*

	<i>Santos</i>		<i>Padang</i>		<i>Guatemala</i>		<i>Mocha</i>	
	<i>Green</i>	<i>Roasted</i>	<i>Green</i>	<i>Roasted</i>	<i>Green</i>	<i>Roasted</i>	<i>Green</i>	<i>Roasted</i>
Moisture								
Apr. 20 .....	8.75	3.75	8.78	2.72	9.59	3.40	9.06	3.36
Sept. 20 .....	8.12	6.45	8.05	6.03	8.68	6.92	8.15	7.10
Ash .....	4.41	4.49	4.23	4.70	3.93	4.48	4.20	4.43
Oil .....	12.96	13.76	12.28	13.33	12.42	13.07	14.04	14.18
Caffeine .....	1.87	1.81	1.56	1.47	1.26	1.22	1.31	1.28
Crude fibre .....	20.70	14.75	21.92	14.95	22.23	15.23	22.46	15.41
Protein .....	9.50	12.93	12.62	14.75	10.43	11.69	8.56	9.57
Water extract .....	31.11	30.30	30.33	30.21	31.04	30.47	31.27	30.44

\* Adopted from Triggs analytical studies of coffee in the 1922 edition of this work.

fluorous salts. It may therefore be expected that this range of mineral ingredients will vary with soil conditions. Chemical examination of the ash shows the presence of potassium, sodium, calcium, magnesium, iron, and possibly other basic elements. These are combined more or less completely with phosphorus to form salts of phosphoric acid, and with sulphur as sulphate and chlorine as chlorides. Sulphur and phosphorus may also occur as constituent elements of proteins, or other organic compounds.

By use of spectroscopic methods numerous other elements have been detected, such as tin, aluminum, manganese, lead, copper, and vanadium.

#### *The Organic Constituents*

The organic constituents of the coffee bean are many and include representatives of the carbohydrates, proteins, fats, oils, and waxes; and a considerable number of other groups of organic compounds. Of these, the most characteristic is the active principle caffeine, or trimethyl xanthin. As in most seeds, or in fact most plant tissues, numerous substances, glucosides, tannin-like bodies, and coloring matters are present, but their range and quantity have never been fully established. Many investigators have reported the presence and given names to more or less definite substances, whose composition is not exactly known, and the occurrence of which has not always been substantiated. As a result the literature of coffee contains numerous terms which have no positive significance. Among these, one finds such terms as "caf-fetannic acid," "Caffeol," and "caffeine." In view of the complexity of the seed, it is highly probable that these alleged substances frequently are mixtures of ingre-

dients, or the decomposition products resulting from the break-down of the complicated waxes and fats, proteins, and carbohydrates.

Analyses have shown, however, that the green or unroasted bean contains but little starch, and a relatively small quantity of sugars, including dextrose, sucrose and possibly mannose. In addition there are larger amounts of some form, or forms, of cellulose which appear in the outer portion and as fiber from the cell walls, and pentose or pentosans, all of which fall within the range of the carbohydrates.

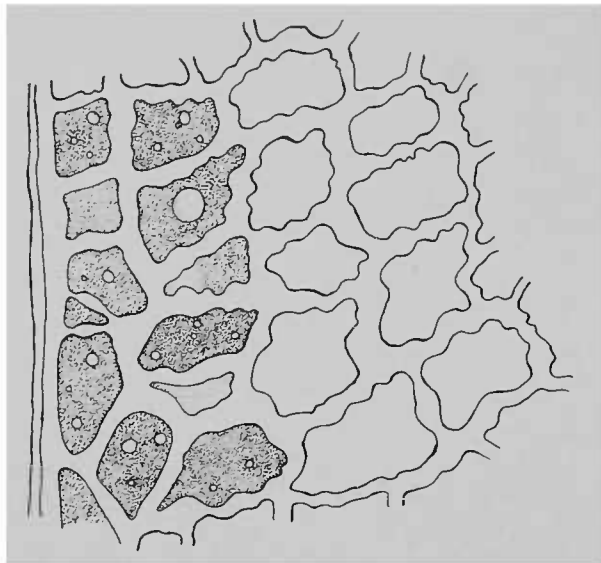
Apparently little is known of the carbohydrates in coffee. Ewell<sup>1</sup> and others have shown that a small amount of sucrose is present. Ewell also showed 9 per cent pentose to be present by conversion to furfural with hydrochloric acid. He also obtained a material which he believed to be a compound of a pentose and galactose. Glucose is probably also contained in small amounts. The starch content is very low and cereal adulterants can be detected by starch reactions. Glucosides are also present.

Of nitrogenous compounds no special proteins peculiar to coffee have been described although doubtless some may exist. In addition to caffeine, an alkaloid known as trigonellin, has also been isolated. Possibly other nitrogen-containing substances exist.

#### *The Fats and Oils in Coffee*

The fats and oils in coffee have been the subject of considerable study. As early as 1837 it was shown by Boutron that coffee contained about 10 per cent fat extractable with ether. Since that time more than a dozen investigators have studied this fat.

<sup>1</sup> *Am. Chem. J.* 14, 473 (1892).



STRUCTURE OF THE GREEN BEAN  
Showing thick-walled cells enclosing drops of oil

Their results agree roughly as to its physical and chemical constants, but differ widely as to the amounts of the various acid components. The fats and oils and waxes occur to the extent of 14 or 15 per cent, in mixtures of great complexity. They are of such character that they are, at least in part, split by action of heat, or roughly separated by different solvents, so that analysis yields a series of products which represent the cleavage products of a cracking process. Few, if any, of the actual fats have yet been absolutely identified. The ready splitting of the fats and waxes by heat indicates that they may be considerably modified by the roasting process, and the extent to which this takes place is dependent upon the severity and duration of the roast. The physical nature of the green bean with its hard, horny outer layer is such that only partial extraction of its contained glycerides can be secured when cold treatment with solvents is applied.

The limits of the constants determined on six different samples of coffee fats by von Noel,<sup>2</sup> as shown in the accompanying table, are probably fairly representative.

Contrary to the view expressed above, Bengis and Anderson<sup>3</sup> report that the fats in raw and roasted coffees were practically identical and that the fat in roasted coffee changed but little, if any, during 16 months' storage. There was, however, a

<sup>2</sup> *Pharm. Zentralhalle* 70, 69-77 (1929).

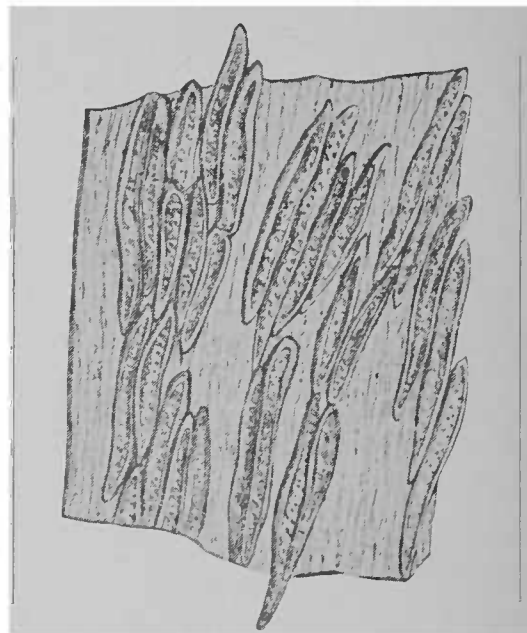
<sup>3</sup> *J. Biol. Chem.*, 105, 139 (1934).

#### LIMITS OF CONSTANTS ON SIX SAMPLES OF COFFEE

Density	0.9228	—	0.9453
Acidity in cc. of 0.1 N			
Alkali / 100 gm.	3.8	—	11.4
Saponification no.	176.1	—	179.15
Iodine value	87.1	—	92.45
Reichert Meisel no.	0.52	—	0.66
Polenske no.	0.20	—	0.25
Unsaponifiable	6.53	—	13.49

distinct increase in the amount of soluble volatile acids.

As previously mentioned, there is little agreement in composition of the glycerides as reported by various investigators. The unsaturated acids are almost entirely made up of linolic and oleic acids. The former is reported in amounts varying from 25—50 per cent and the latter from 2—23 per cent. Palmitic acid is the saturated acid occurring in largest amounts—23 to 33 per cent. Carnaubic is given by various writers from 0 to 14 per cent. Stearic, daturic, capric, and an unsaturated hydroxy acid have also been reported in

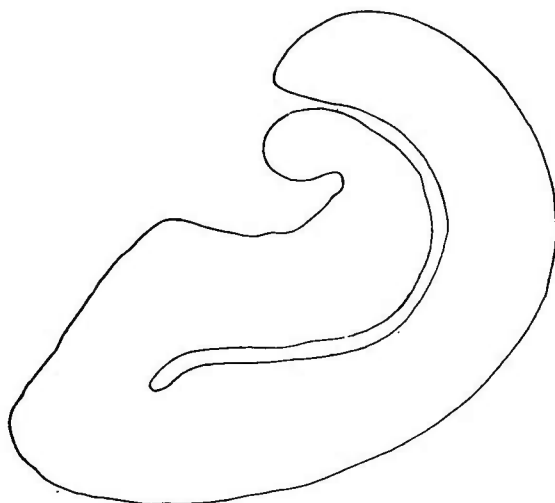


PORTION OF THE INVESTING MEMBRANE, SHOWING ITS STRUCTURE

Drawn with the camera lucida, and magnified 140 diameters

smaller amounts. Bengis and Anderson found that the ratios of the acids did not change appreciably during 16 months' storage.

Using peroxide content as a measure of rancidity Peakes and Emerson (unpublished research M.I.T.) were unable to se-



CROSS-SECTION OF THE ENDOSPERM OR HARD  
STRUCTURE OF THE GREEN BEAN

cure any evidence that the fat was responsible for the rancidity of coffee. A method was developed for the extraction of the fat and peroxides from the coffee at ordinary temperatures. Organic peroxides were found in samples of old coffee (7 months) but such coffee was not as rancid as coffee which had been roasted more recently and had only a trace of peroxide.

The fat extracted from coffee contains a large amount of unsaponifiable matter. Bengis and Anderson<sup>4</sup> have examined this material and found it contains a small amount of a phytosterol, very similar to sitosterol, and a crystalline substance which they term "Kahweol." "Kahweol" is a very unstable compound which changes rapidly in contact with air. It is unsaturated and contains one carbonyl and one hydroxyl group. It has a high optical rota-

tion  $\alpha \Big) \frac{21}{D} = -204.54^\circ$ .

#### *Chemical Knowledge Fragmentary*

It is evident from the foregoing that our actual knowledge of the chemistry of the coffee bean is of fragmentary nature, despite the amount of work which has been bestowed on it, and the many speculations that have been offered. This is probably due in part to inherent complexity, and in part to the fact that coffee as it is found in trade is not a product of standardized quality and uniformity of ripeness, but

<sup>4</sup> *J. Biol. Chem.* 77, 99-112 (1932).

contains many stages in maturity, and therefore probably substances in transitional states of aggregation or transformation. This would account in part for the conflicting data which seem to characterize published reports.

Two things pertaining to the chemistry of coffee stand out clearly: (1) that caffeine is the most definite ingredient in most types of coffee, although species of the genus *Coffea* are known in which it is said to be absent; and (2) that the chemical substances which give aroma and flavor, and which are most generally referred to when the chemistry of coffee is considered, are only developed when the green bean is subjected to the roasting process. This chemistry of the green or unroasted bean is therefore greatly different from that of the roasted bean, and especially that of the fully roasted bean.

#### *Changes Caused by Roasting*

Despite the apparent simplicity of the process of roasting, the multiplicity of decompositions and interchanges that are brought about is remarkable. This process, which is a destructive distillation accompanied by dehydration and both oxidation and reduction in the different structures, could hardly fail to yield combinations far different from those occurring in the green bean. The following changes may be postulated:

Not only is free moisture reduced, but the carbohydrates and possibly some of the other ingredients lose water in connection with the formation of caramel and related products which modify the color and set free other decomposition products which affect the flavor and aroma.

Some of the reactions which may occur may be suggested in the following statements:

1. Water is driven off, part of the steam formed assisting in other reactions within the bean.
2. Volatile substances may be wholly or partially expelled.
3. The sugars and starches are partially caramelized and darkened, and some of them, such as the pentosans, yield small quantities of furfuraldehyde and other products. The furfuraldehyde may be reduced at once to furfuryl alcohol, and some CO<sub>2</sub> to carbon monoxide. Esterification of furfuryl alcohol with aliphatic acids may take place.
4. Cellulose is partially carbonized and darkened.



5. Carbon dioxide gas is formed by decomposition or by oxidation.

6. Woody constituents made up of cellulose addition products and modifications undergo cleavage changes and are partially carbonized.

7. Glucosides are split into their component groupings, and some of their decomposition products are driven off.

8. Protein substances undergo changes, generally hydrolytic in character, resulting in partial cleavage.

9. Free caffeine may be volatilized to some extent.

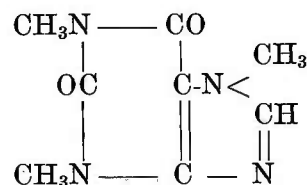
10. The fats are affected; volatile fatty acids are driven off and complex fats are "cracked" to form simpler ones and the other characteristic products of decomposition of fats by heat.

It is thus seen that the whole process of roasting is exceedingly complex. Obviously the degree or length of heating is of great importance and largely determines how extensive these internal reactions may be. The higher and darker the roast, the more deep-seated these changes are, and the more the final substance, roasted coffee, differs from the original green bean. The obvious changes are indicated by the darkening and oily appearance of the coffee. Less obvious is the evolution of carbon dioxide, the most characteristic product of combustion, which is formed in considerable quantity, part of it being disseminated into the surrounding atmosphere, and part held mechanically or physically within the bean. Other gaseous products are also formed in small amounts, among them ammonia and carbon monoxide, and probably several others of unknown identity.

#### The Caffeine Ingredient

Throughout this series of deep-seated changes, one component, caffeine, persists, although some loss by volatilization is noted. As has been earlier stated, caffeine is the most characteristic ingredient of coffee, and the one which confers on it its special invigorating and stimulating qualities. This substance, also found in tea, in maté, and to some extent in cocoa and a few other plants, occurs not only in the seed, but also in smaller quantities in the

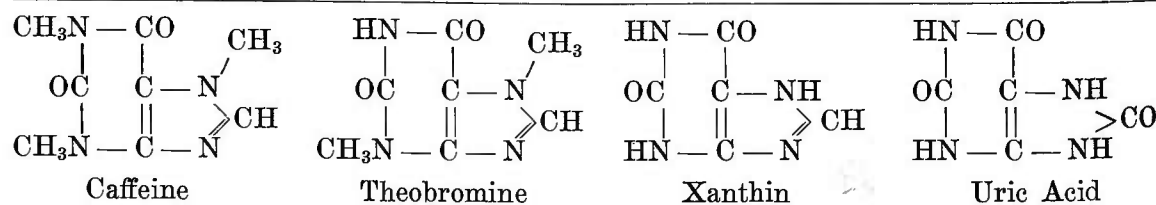
flowers, the leaves, and small stems, and in the pulp of the berry surrounding the seed. In its free and pure state it forms slender white, needle-shaped crystals with silky lustre, and when crystallized from solutions these are often in felted masses or form in clusters of varying size and handsome appearance. Its composition is  $C_8H_{10}N_4O_2$ , and its structure is represented by the arrangement



which gives it the name of trimethyl xanthin. It is of interest to note that it appears to be closely related to the theobromine which constitutes the active principle in cocoa, which is a dimethyl xanthin. Although there is no evidence that either of these substances is derived from xanthin (a constituent of animal tissues especially) or of uric acid, the chemical relationships between these four substances is of interest, and is shown by comparison of the four structural formulæ given below.

The substitution of the methyl groups ( $\text{CH}_3$ ) for the H atoms seems to have conferred marked stimulating properties, for both caffeine and theobromine possess the power of acting in this manner on the central nervous system. The structure of these bodies and the position of the methyl groups was worked out by the great German chemist Emil Fischer.<sup>5</sup> Caffeine is soluble in water and in all the common organic solvents at ordinary temperatures, although the rapidity of solution is increased with increasing temperature. Water near boiling temperature dissolves it almost instantly, a fact that is of special significance in the preparation of beverage coffee. At  $85^\circ\text{C}$  about 90 per cent of the caffeine in ground coffee is dissolved in

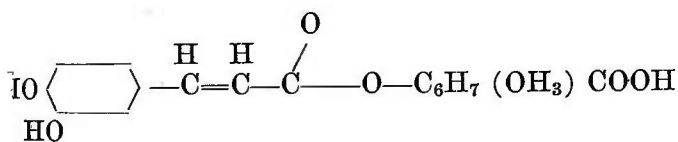
<sup>5</sup> *Ber.* 1895 (Vol. XXVIII, p. 3137); 1899 (Vol. XXXII, p. 435); 1900 (Vol. XXXIII, p. 3035).



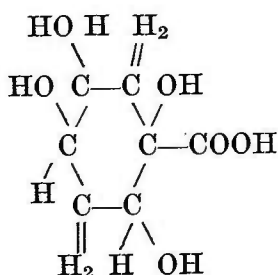
about one minute. If crystalline caffeine is heated slowly it begins to sublime at about 120°C. and sublimes completely at 178°C. The melting point of pure caffeine is about 235-7°C, when it changes to a clear liquid. The fine crystals of caffeine can sometimes be observed, especially by use of the microscope, on the surface of coffee which has been roasted and then quickly cooled.

*Caffeine Complexes*

A question of great interest concerns the manner in which caffeine occurs in the coffee bean. Gorter states that it occurs in coffee in combination with the potassium salt of chlorogenic acid in the ratio of one mole of caffeine to one mole of chlorogenic acid. He isolated such a complex in the crystalline state. Although he found this material to be water-soluble, he states that caffeine cannot be extracted from it with anhydrous solvents. We are largely indebted to Gorter for our knowledge of the structure of chlorogenic acid although the formula now accepted is that suggested by Freudenberg.<sup>6</sup>



which makes it an ester of caffeic and quinic acids.



Recently it has been stated that coffee in which the chlorogenic acid has been hydrolyzed into its components, caffeic and quinic acids, is less active physiologically than one in which the chlorogenic acid exists as such.<sup>7</sup>

In an extended study of the occurrence of caffeine in the bean, Emerson and the writer<sup>8</sup> arrived at results which are not

antagonistic to the theories of Gorter although differing in certain respects. Our results indicated that caffeine exists in a series of complexes, as well as in the free state, both in green and in roasted coffee, and that these complexes apparently differ markedly in their response to anhydrous organic solvents.

*Caffeine Determinations*

Thorough extraction of ground, roasted coffee beans with these solvents, acetone, ether, chloroform, alcohol, benzene, and toluene, all of which dissolve pure free caffeine, gave various solutions which on the removal of the solvent yielded residues of varying composition and varying widely in quantity. After the coffee bean had been thoroughly extracted with one of the above solvents—three fresh portions of solvent being used—a further extraction of the grounds was made with another solvent and this process was repeated, rotating the solvents in definite order so that a whole series of extracts was obtained. These were carefully examined as far as possible. Their appearances varied from a slight translucent, nearly colorless, oily residue to a heavy, dark, reddish-brown residue of considerable quantity. The former was invariably obtained when using ether and the latter when using acetone or even benzene. Ether yielded a smaller residue than any other solvent used.

Some of these residues thus obtained had a distinct coffee odor, especially where it was the initial extract, but if it was the third or later consecutive extract with the same solvent the residue had a woody odor, not in the least suggestive of coffee. There was also noticeable an odor of a vegetable acid, more or less rancid, and suggesting in some instances butyric acid. Some of these residues, on further treatment with solvents to effect, if possible, purification and further separation, often yielded, on the one hand, caffeine, and on the other, waxy or gummy substances which it was difficult to purify further, although we were able to separate bodies which were of fairly high melting point, and which were very highly colored, often almost black.

The various residues from each solvent, above mentioned, were examined for caffeine and preliminary determination indicated that there was a wide variation in

<sup>6</sup> Ber. 53, 232-9 (1920).  
<sup>7</sup> E. Ebinger. Pharm. Zentralhalle 73, 84: 86 (1932).  
<sup>8</sup> Report of an Investigation of Coffee, 1923.

## WORKS PUBLISHED ON THE AROMATIC PRINCIPLES OF COFFEE

<i>Investigator</i>	<i>Reference</i>	<i>Constituents</i>
O. Bernheimer*	Monatsh. 1, 456 (1880)	A methyl derivative of saligenin, caffeine, higher fatty acids, acetic acid, hydroquinone, methylamine, pyrrol, acetone.
A. Monari and L. Scoccianti*	Annali di Chimice e di Farmacologia 1 70, (1895)	Pyridine.
H. Jaeckle*	Z. Untersuch. Nahr. u. Genuss 1, 457 (1898)	Furfural, caffeine, pyridine, ammonia, trimethylamine, acetic and formic acids, acetone.
E. Erdmann	Ber. 35, 1946 (1902)	An isovaleric acid in large amounts, a little acetic acid, phenols, furfuryl alcohol, and a fraction b.p. 93° at 13 mm. containing nitrogen and having the odor of coffee (in extremely small amounts).
G. Bertrand and G. Weismuller	Compte Rendu 157, 212 (1913)	Pyridine 200-250 mg/kg coffee.
Sayre	Bull. Pharm. 30, 276-8 (1906)	Pyridine.
R. E. Sethness	Tea and Coffee Trade J. 46, 570 (1924)	Methyl ether of saligenin claimed to be principal constituent of coffee oil.
H. Schmalfluss	Biochem. Zeitschrift 216, 330 (1929)	Diacetyl.

\* Analyzed condensed roaster gases.

the amount of caffeine in the initial residues; by the term "initial residue" is meant the first residue obtained in the extraction of the coffee bean with any of the solvents used. As the extracts were later made, allowing for full extraction, the inference is that caffeine must exist in part at least, in a combined form with some other substance. The solvents used were those that dissolve free caffeine more or less easily cold, and readily when warm.

Quantitative analyses, in which solvents were used in rotation on the same samples of coffee and followed by water extraction, yielded a total caffeine content which was identical with the total amount obtainable by hot water extraction of a similar portion of the original sample. This series of experiments established our belief that there is a marked variation in the distribution of caffeine in the coffee bean. It would appear that one possible explanation, though not necessarily the only one, is that there are various caffeine complexes in the coffee berry and that some of these are more readily soluble in a given solvent than others are in the same solvent. This would account for the varying results occurring above. If this is the case, it would appear that the subsequent extraction of the residual coffee grounds, or the coffee and magnesium oxide, as the case may be, with boiling water, should decompose any complex remaining unextracted by the solvents, thus making possible a fairly uni-

form figure for the total caffeine content. This was found to be the case.

Special analyses also showed that of the total caffeine in coffee the solvents listed can dissolve approximately the per cent placed opposite its name in the accompanying table.

TABLE OF CAFFEINE SOLVENTS

<i>Solvent</i>	<i>Green</i>	<i>Roasted</i>
	<i>Coffee</i>	<i>Coffee</i>
	<i>Per Cent</i>	<i>Per Cent</i>
Acetone .....	30	50
Chloroform .....	45	50-60
Ether .....	5	25
Carbon Tetrachloride .....	35	35

Further data on this matter and on the determination of Caffeine are given in the Report of an Investigation of Coffee, published by the Brazilian-American Coffee Promotion Committee in 1924 and reprinted in 1927.

*The Aromatic Principles*

Much interest centers in the aromatic principles of coffee. At present, we do not know what combination of compounds give coffee its pleasant aroma. Certain compounds which contribute to coffee's fragrance and taste have been isolated. The variety of the compounds obtained makes us rather certain that no one compound is responsible for the odor and taste of coffee. The nature of these compounds

also leaves little doubt that compounds other than those which have been thus far isolated from coffee are necessary to produce its aroma. The accompanying table summarizes the works published on the aromatic principles of coffee.

It is rather strange that Bernheimer and Sethness should both obtain the methyl ether of saligenin as the principle constituent of the volatile oils in coffee and make no mention of furfuryl derivatives, while exactly the reverse is true of Jaeckle and Erdmann. Peakes and Emerson (unpublished research M.I.T.) have recently obtained evidence that a portion of the furfuryl alcohol exists in combination with the lower aliphatic acids in the form of esters.

This would indicate that Jaeckle and Erdmann obtained decomposition products of these compounds.

In judging work along these lines we should consider the difficulty of separating a few grams of volatile oil from very large amounts of coffee. Erdmann and Sethness both used 100 kilograms or more of coffee. The usually convenient method of steam distillation should not be used, because decomposition of the desired products takes place. It is also very likely that some precautions should be taken against the action of atmospheric oxygen. These facts were probably not sufficiently appreciated at the time much of the work was done.

---

## SCIENCE SOLVES SOME COFFEE PROBLEMS

CHEMICAL TESTS OF FLAVOR LOSS—CUP FLAVOR TESTS—USEFULNESS OF VARIOUS GRINDS—CONTAINER TESTS—VACUUM METHOD—EFFECTS ON FLAVOR—HOME CONTAINER TESTS—GAS AND MOISTURE DETERMINATIONS

By P. W. PUNNETT, PH.D.

Research Associate, Teacher's College, Columbia University, New York

**T**HE application of science to a product or industry generally follows a fairly definite course. First comes the separation and identification of definite elements or compounds present at different stages. The next step usually involves the application of various methods of measurement in order to gain an insight into the progress of the reactions which are present. Finally comes the application of the knowledge thus acquired in the first two steps to the process or product in order to control the reactions and make a better or more uniform product—often at a lower cost. Of course all of the above procedures may be going on at various rates at the same time.

In the case of coffee the first procedure has been under way for a good many years, and is still being used extensively, but the surface hardly has been scratched as yet. In the case of the second step, the application of quantitative measurement, little

was accomplished until a few years ago, outside of the general analysis of green and roasted coffees for such constituents as moisture, ash, caffeine, etc., but careful scientific investigations inaugurated quite recently by Punnett and Eddy at Teachers College, Columbia University, New York, have already answered some of the coffee packers' most pressing problems. In September, 1930, Punnett and Eddy published an article<sup>1</sup> describing a practical method for the quantitative determination of flavor in coffee. Briefly this method determines the amount of flavor in the cup under test by comparison with the flavors present in standard cups. In this way it is possible to arrive at a figure for the amount of flavor present in the test coffee in terms of percentage of that present in the freshly roasted sample. Further, by first determining the amount of coffee flavor present

<sup>1</sup> "What flavor measurement reveals about keeping coffee fresh," *Food Industries*, New York, Sept., 1930.

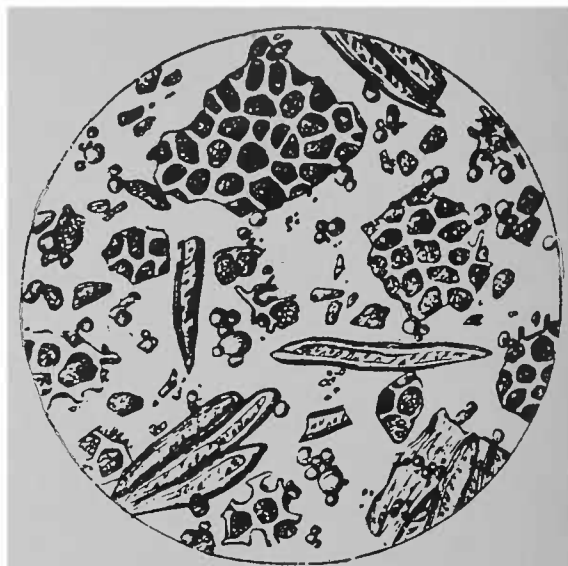
and then repeating the determination, this time using a series of cups each of which contains the determined percentage of fresh coffee to which are added an increasing series of amounts of very old and stale coffee. In this way it is possible to determine also the amount of stale flavor present. By using this method it is possible to follow day by day the flavor changes that occur in a sample of roasted coffee and to express these results in figures which may be compared at any time—years after, possibly—with similar determinations made on other samples or under other conditions.

The results of such a set of tests demonstrate that the rate of flavor loss in ground coffee is quite rapid for the first two weeks after roasting and grinding; about 60 per cent being lost in this period. After that there is only a very slow loss of the residual flavor. About ten days after roasting an entirely different flavor—the familiar “stale” flavor—appears, increases rapidly for about two weeks, and thereafter only slowly. Bean coffee also loses flavor though not quite as rapidly, and the stale flavor does not appear until three weeks or so after roasting. The use of a slipcovered can seems to protect the coffee from deterioration only very slightly.

#### *Cup-Flavor Comparisons*

The standard cup method of flavor measurement has made it possible to develop a method for testing and comparing the efficiency of coffeemaking devices. In an article<sup>2</sup> published in 1933 such a method is described and the results of testing over forty pots tabulated. The brew made by each pot, using a definite proportion of water and coffee of a controlled fineness, was evaluated for flavor strength by comparing it with a series of standard cups in which amounts of the same coffee in a graduated series were used. The 100 per cent cup contained the same proportion of coffee to water as that used in the pots. At the same time a determination of the amount of sediment in the brew was made by comparing a sample with a series of samples of a filtered brew to which weighed amounts of coffee dust had been added. Of course there are other factors which also must be taken into account in making a complete examination of a coffee brewing

<sup>2</sup>The “Good” is in the Brewing, by P. W. Punnett, *Food Industries*, New York., Sept., 1933.



GROUND COFFEE UNDER THE MICROSCOPE

device: materials of construction, particularly with respect to their effect on the brew flavor; ease of cleaning and operation; safety, etc. The standard cup method and the clarity determination, however, have made it possible to obtain a measurement of the performance of a coffee pot and to compare the efficiency of various pots.

#### *Usefulness of Various Grinds*

Until quite recently no one had made any accurate comparisons of the relative usefulness of various possible grinds of coffee. The standard cup method made such a comparison possible, as discussed in a recent article by Punnett.<sup>3</sup> The results by the use of each of four grinds in each of 42 pots are tabulated in the article previously mentioned.<sup>2</sup> They indicate that there has been no uniformity or standardization of coffee grinds throughout the country, and that a much finer grind than has been considered suitable gives better results in all types of pots with no increased cloudiness. Since the time when that work was done, there has been a rapid adoption of what has been called the “Universal” or “All-Purpose” grind by some of the country’s largest roasters. The use of this grind has also stimulated improvements in grinding machinery to maintain production rates. A brief discussion of coffee grinds, illustrated

<sup>2</sup> Loc. cit.

<sup>3</sup> “The Proof is in the Drinking,” *Food Industries*, New York., Aug., 1933.



by photographs, appeared in the *Tea and Coffee Trade Journal*.<sup>4</sup>

#### *Coffee-Container Tests*

The investigation of flavor deterioration<sup>2</sup> has raised a question as to the value of the various types of packages for coffee. Since the flavor of coffee is really what the roaster is selling—and the only thing that cannot be imitated as yet—the protection which the package gives to this flavor is a matter of great importance. The consumer also is interested in packaging from the standpoint of economy; in obtaining the maximum of flavor at the minimum of cost. A series of tests by Punnett and Eddy at Teachers College, Columbia University, New York, afford an answer to this question. A single lot of freshly-roasted ground coffee was packed in 15 different types of containers as follows: screw-top can with inner drumhead of cardboard; glass jar closed by screw cap containing a waxed liner; Kraft paper bag; white paper bag with glassine liner; square fiber can with metal bottom and top closed by a screw cap and inner drumhead; carton wrapped in parchment paper; carton wrapped in wax paper; tin-foil covered carton; friction-top can; slip-cover can; carton with glassine lining and Kraft wrapping; double carton; square fiber can with metal top and bottom, screw cap, inner drumhead, and inner paper and foil bag; vacuum-packed glass jar closed by Anchor cap; and vacuum-packed tin can. Tests were made at intervals of two to three days, opening a fresh package of each type each time and comparing by the standard cup method with a freshly roasted sample of the green blend used for the original roast.

In the case of the vacuum-packed glass jar, it was found that particles of coffee had been lodged under the seal during the evacuation process and none of the jars was tight; all contained air. Hence, this type of package did not have a fair test.

The results of tests extending over four weeks showed that in every case, except that of the vacuum-packed can, the contents of the packages deteriorated rapidly and became stale on the tenth day after packing. After the tenth day the staleness increased rapidly. The curves expressing

these results all agreed very closely with those given in the article on flavor measurement.<sup>1</sup> The coffee in the vacuum-packed cans slowly lost a small amount—about 20 per cent—of its flavor because of air left in the cans at the time of sealing, since the vacuum obtainable at that time was not as high as is desirable.

#### *The Vacuum Method*

A large number of experiments have been made upon the vacuum method of packing coffee at Teachers College. This work may be summarized briefly at this point.

In order to measure the volume and pressure of the gases present in a can of vacuum-packed coffee and to remove a portion for analysis, it was necessary to construct a special apparatus. This consisted of a metal frame into which the can could be clamped against a piece of rubber containing a hollow piercing point. By screwing up the clamp, the point could be forced through the metal and a connection formed with the contents of the can. The point was connected with a glass sampling bulb in which mercury was used as the confining fluid. Before making contact between the piercing device and the can, the bulb, the connecting tubing, and the point were filled with mercury by raising a leveling bulb. In this way all air was eliminated from the system. After piercing, the mercury was drained back from the point into the sample bulb and its level adjusted to a mark on the upper stem. The gas pressure was then measured by determining the difference in levels of the mark and the mercury in the leveling bulb. Next the leveling bulb was lowered until the mercury stood at a mark on the lower stem of the sample bulb and the pressure read again. The volume of the bulb between marks was determined previously, and likewise the volume of the tubing between the upper mark and the piercing point. From these measurements the volume and pressure of the gas in the can can be calculated as follows:

- V = volume of gas in can
- $v_1$  = volume from point to upper mark
- $v_2$  = volume of sample bulb between marks
- P = pressure in can
- $P_1$  = pressure determined at upper mark
- $P_2$  = pressure determined at lower mark
- B = barometric pressure of atmosphere

<sup>2</sup> Loc. cit.

<sup>4</sup> *The Tea and Coffee Trade Journal*, New York, Oct., 1934, p. 338.

<sup>1</sup> Loc. cit.

$$\frac{V}{V + v_1} = \frac{B + P_1}{P} \quad (\text{Equation 1})$$

$$\frac{V + v_1}{V + v_1 + v_2} = \frac{B + P_2}{B + P_1} \quad (\text{Equation 2})$$

In Equation 2 the only unknown quantity is  $V$  and hence it is simple to determine its value. Then by substituting this value in Equation 1,  $P$  may be determined. By subtracting the barometer reading from  $P$ , one can determine whether the internal pressure is above or below that of the atmosphere.

A second storage bulb containing mercury is also connected to the sample bulb and, after making the pressure reading, the gas sample can be forced over into the storage bulb and another portion of gas removed from the can by again lowering the mercury in the sample bulb, etc. When sufficient gas has been collected in the storage bulb, it is disconnected and the gas analyzed for carbon dioxide, carbon monoxide, oxygen, and nitrogen in any of the usual gas analysis apparatus.

From the values thus obtained for gas pressure and percentage of nitrogen, the original vacuum present in the can at the time of sealing can be calculated—thus:

If  $P$  = the gas pressure in the can,  
and  $N$  = the fraction of the gas which is  
nitrogen

then  $P \times N$  = the partial pressure of the nitrogen in the can,

$P \times N$

and  $\frac{P \times N}{79} \times 100$  = the original pressure of the air left in the can at the time of sealing.

If the can happens to have bulged ends due to pressure, its volume can be determined by immersion in water. The normal volume can be obtained from a can which has no bulge and the volume and pressure of gas in the bulged can corrected for the swell before calculating the original air pressure in the can. The accuracy of the whole process depends, of course, on the precision of measurement.

#### *Analysis of Results*

The use of the above method in the case of a large number of vacuum-packed cans of coffee revealed the following:

1. The gases evolved from roasted coffee seem to be composed almost entirely of carbon dioxide and carbon monoxide.

2. The relative proportion of the dioxide and monoxide probably depends on several factors, one of which is the duration and extent of the roasting process. In general, the darker the roast the greater the proportion of carbon monoxide in the gas. In the case of a medium roast the carbon monoxide usually amounts to 4 to 7 per cent of the carbon dioxide.

3. The oxygen in the air left in the can at the time of sealing disappears quickly. For instance, in one case where the original vacuum had been 21 inches, about three-fifths of the oxygen left in the can disappeared in five weeks after packing; in another, where the initial vacuum was 19 inches, about one-half of the oxygen disappeared; in another, with an original vacuum of 23 inches, two-thirds of the oxygen disappeared. In a series of six cans packed under 28 to 29 inches of vacuum, the residual oxygen had completely disappeared in two weeks. In the last case the volume of oxygen disappearing was only 6-7 cc., while in the other instances mentioned, 20-25 cc. was absorbed.

#### *Effects of Vacuum on Flavor*

The standard cup test has been used on the coffee in many of the cans which have been subjected to gas analysis. These tests have demonstrated that the original vacuum used in packing determines the extent of any flavor loss that may occur in the can. To put it another way, the larger the amount of air that is *not* removed from the can, the greater the deterioration that occurs in the can.

1. If the original vacuum is about 29 inches, the flavor loss is not over  $2\frac{1}{2}$  per cent, an amount that can be detected only by the most sensitive, highly-trained palate. For all practical purposes the deterioration is zero.

2. If the original vacuum is about 27 inches, the flavor loss is about 10 per cent of that originally present.

3. At 25 inches, the loss is about 30 per cent; at 22 inches 40 per cent; and at 20 inches there is enough air present to insure the loss of about 60 per cent of the flavor and the development of considerable staleness.

Such losses in flavor as these depend entirely upon the oxygen left in the can at the time of sealing and *not* upon the length of time, beyond the first month or two, that the coffee has been in the can. After the oxygen left in the can has reacted with and destroyed the coffee flavor—a process which requires one or two months—no further change occurs. A series of samples of a nationally known brand of coffee were examined both by the gas-testing and the standard-cup methods. The dates of pack-

ing had been stamped into the metal of the cans. The age of the samples extended from one month back to eight years and seven months. During this time the flavor of the blend had been unchanged. The samples showed that any flavor loss that had occurred during this period was solely dependent on the original vacuum as determined by the gas analysis method. For example, tests on a can seven years old indicated 24½ inches, or better, original vacuum and a flavor strength of 90 per cent. The one that was eight years and seven months old had originally a 20-inch vacuum and gave a flavor test of 40 per cent fresh + 40 per cent stale. One two months old had been packed under 28 inches and was 95 per cent in strength.

In this connection, there are two objections which often have been raised against the use of vacuum packing by individuals whose minds are closed to any evidence tending to upset their preconceived notions. The first one is, "The process of pumping the air out of the can pulls out some of the flavor." Of course, many of the tests made in the laboratories of Teachers College on coffees packed under vacuum have demonstrated that if the vacuum is high enough the flavor loss is zero. But to make the proof more impressive, the following test was made. A pound can of freshly ground coffee was sealed in an ordinary coffee can bearing a short tube which could be connected directly to a high vacuum pump. This pump was operated steadily for six hours, producing in the can a vacuum of over 29½ inches. At the end of that time the coffee in the can was cup tested against a fresh roast and against some of the original roast which had not been subjected to a vacuum. No difference could be detected between the cups in spite of the fact that the coffee in the can had been subjected to the pumping process for a period many thousand times as long as that used in commercial packing. It has been shown by Punnett that the prolonged application of a vacuum to a can of coffee will not result in the removal of more coffee gas than would be evolved from the particles without vacuum.<sup>5</sup>

The second objection made by the uninformed often takes this form—"Yes, the coffee will keep perfectly while it is in the

sealed can, but after the can is opened the flavor fades right away; much faster than occurs in a freshly roasted sample." This, too, has been proven a fallacy. Sample after sample of vacuum-packed coffee, of many blends and many ages, have been allowed to stand in the laboratory after opening and the rate of flavor deterioration determined by the standard cup test. In every test the rate of flavor loss was practically identical with that of freshly roasted and ground coffee and the stale flavor first appeared on or about the tenth day after opening.<sup>1</sup> If the original vacuum is low enough—say 25 inches—to result in some deterioration in the can, the flavor-strength curve naturally begins at some point lower than 100 per cent. Loss of flavor is then slowed up for three or four days until the curve joins that of coffee freshly roasted and ground. If the vacuum used was 29 inches the curve of flavor loss follows that of the freshly roasted sample almost exactly. In other words, vacuum packing does not cause a more rapid rate of flavor loss after the can is opened.

#### *Coffee Left in the Opened Can*

Many cook books and home economics teachers advise the housewife to put the coffee into tightly sealed jars when the vacuum can is opened—a fruit jar for instance. However, if one considers the evidence of tests recently completed by Punnett and B. D. Balart, it would seem that no method practical for the housewife can do more than effect an almost imperceptible decrease in the rate of deterioration. In these tests a blend of green coffee was roasted, ground, and packed under a 28½-inch vacuum. The cans were held at a room temperature for one month. At that time, two were opened and compared as to flavor, no difference being detected. A quart fruit jar fitted with a rubber gasket was filled from the contents of one of the cans and the other can merely re-covered with its top. A fresh roast was made from the same green blend and after grinding was divided between a similar jar and an ordinary paper coffee bag. The containers were opened twice daily as would be the case in the home. Comparative multiple-cup tests were made every day or two. Similarly, the other two vacuum cans were opened at

<sup>5</sup> *The Tea and Coffee Trade Journal*, New York, Nov., 1934, p. 428.

<sup>1</sup> *Loc. cit.*

the end of six weeks. Half of each was put into a quart fruit jar and the remainder left in the can and cup tests run as before.

Very small differences were noted between the vacuum-packed and the fresh-roast. From actual measurement they were of the order of  $2\frac{1}{2}$  per cent in strength due to the extremely slight loss in the can consequent on the small amount of air left when packing. As already noted, a difference of this amount can only be detected by the exceptional individual. As regards differences between the coffee left in the opened can and that placed in the jars, they simply did not exist. Nor was the rate of deterioration any different in the vacuum-packed coffee from that freshly roasted at the time of opening the cans.

#### *Gas and Oxygen in Roasted Coffee*

In order to obtain some insight into the actual quantity of gas in roasted coffee, its pressure in the coffee cells, and the extent of oxygen absorption, an all-glass apparatus using mercury-sealed valves was constructed at Teachers College. It consisted of a large bulb capable of holding one pound of coffee, connected to a graduated gas burette and to a valve through which gases could be introduced into or removed from the system.

In the first run, a blend of three parts Santos 4's and one part of Medellin Excelsco was roasted, ground, and a portion separated which passed through a 20-mesh sieve and was held on a 30-mesh sieve. One pound of this was sealed in the bulb. Every day or two the gases evolved from the coffee were pumped off through weighed absorbers and the amount of water vapor and carbon dioxide determined. During two months this sample of coffee gave off 2.0495 g. of carbon dioxide and 0.4030 g. of water. The system was then filled with pure oxygen and the room temperature and barometric pressure noted. Daily readings were made of the amount of oxygen absorbed; corrections being made for changes in temperature and pressure. In 110 days 345 cc. of oxygen was absorbed. It was then decided to pump the system free from oxygen and fill with nitrogen in order to determine the contraction due to the filling of the cells in the granules. While pumping out the oxygen, the gas was passed through the absorbers and 0.3431 g. of carbon dioxide plus 0.5160 g. of water were collected.

The total carbon dioxide recovered then was 2.3926 g., equivalent to 1218 cc. at 0°C and 760 mm. At 25°—average room temperature—this becomes 1330 cc. If we assume that the carbon monoxide which was not determined was 5 per cent of the carbon dioxide, the total volume of these two gases is approximately 1400 cc.

The total amount of water given off by the coffee was 0.9190 g. The sample originally contained 2.47 per cent or 11.214 g. total. Hence, the moisture lost reduced that in the coffee to 2.27 per cent.

When nitrogen was admitted to the system it slowly disappeared until at the end of three months 178 cc. had been absorbed. This represents the volume of the pores or cells remaining in the coffee after grinding. Since the carbon dioxide plus the carbon monoxide originally occupied this space, a simple calculation gives its pressure when so confined as 117 pounds absolute, or 112 pounds above atmospheric. The pressure may be somewhat less than this, due to absorption of the gas on the surfaces.

The foregoing procedure was repeated using the same blend but a coarser grind—through 10 and on a 20 mesh. In  $3\frac{1}{2}$  months 0.2005 g. of moisture was given off, along with 2.6460 g. of CO<sub>2</sub>. The volume of the pores was found to be 134 cc. by means of the nitrogen absorption determination. During the subsequent removal of the nitrogen, 0.1510 g. more of water and 0.0955 g. more of CO<sub>2</sub> were recovered, making a total of 0.3515 g. of water and 2.7415 g. of CO<sub>2</sub>.

The original moisture content of the coffee was 2.26 per cent. Hence, the water lost decreased this to 2.18 per cent. The CO<sub>2</sub> is equivalent to 1523 cc. at 25°C and 760 mm. If 5 per cent is added per carbon monoxide the total gas is 1600 cc. If this volume of gas is confined in the 134 cc. of pore volume the pressure would be 162 pounds above atmospheric.

After removal of the nitrogen, the system was filled with pure oxygen and readings taken at various intervals. Part of the initial contraction in volume was due to the filling of the pore space with gas. Correcting for this, the amounts of oxygen absorbed by the coffee have been:

<i>At the end of</i>	<i>Volume of oxygen absorbed</i>	<i>Rate per day—total</i>
2 months	135 cc.	2.25 cc.
4 months	350 cc.	2.92 cc.
6 months	455 cc.	2.53 cc.
8 months	660 cc.	2.75 cc.
10 months	1170 cc.	3.90 cc.

The absorption is still going on as this is written at the accelerated rate which began to show up at the end of the seventh month. At present it is about 13.5 cc. per day with no indication of any slowing up. It is probable that practically all of the oxygen which has been taken up has reacted with the vegetable oil present in the coffee. This is not taken to mean that oxidation of the fat present is responsible for the stale flavor which appears in ground coffee at the end of one and one-half weeks' exposure.

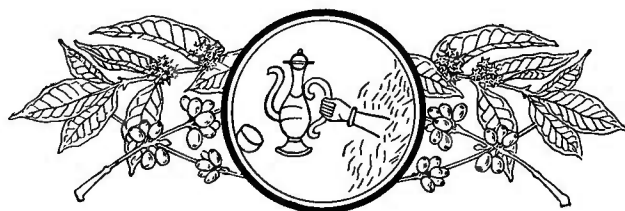
#### *Meaning of the Term "Acid"*

In the coffee trade it is customary to speak of "acid" coffee, but the term is somewhat inaccurate in a scientific sense. Brews made from a large number of coffees, both single varieties and commercial blends, have been tested for pH value using the quinhydrone electrode. All—Santos, Bogota, Maracaibo, Mexican, Mocha, Java, etc.—fall within the range of 4.90 to 5.30. This is only very weakly acidic. In fact, if a water solution of acetic acid is made up to have a pH within this range, the acidity cannot be detected ordinarily by taste. The age of the sample of coffee and the color of roast seemed to have little or no effect on the measurements. Hence, the term "acid" as used in the trade does not refer to a greater amount of actual acid in the coffee, but to a certain characteristic flavor.

#### *Variable Moisture Content*

Some work has been done on the relation of moisture in the air to the moisture content of coffee exposed to the air. It is as yet incomplete, but so far indicates that green coffee is very sensitive to air humidity. At a relative humidity of about 18 per cent, as may occur in heated buildings during winter weather, green coffee may decrease in moisture content to around 4.5 per cent. If the humidity is around 40-60 per cent, as will be the case in clear weather in the summer, the coffee moisture will be 7-10 per cent. A 95 per cent humidity as in rainy summer weather may send the moisture content up as high as 22-24 per cent. It is suggested that the larger coffee buyers might find it financially wise to buy green coffees on a standard moisture content basis as is done in the case of grain in the milling industry. Since roasted coffee runs fairly uniform in moisture content—2-3 per cent—it is evident that most of the moisture in green coffee is driven off in the roasting process. Hence, one per cent decrease in moisture in the green will give about one pound more of roasted coffee per bag.

A few experiments have demonstrated that the moisture content of green coffee can be determined in a few hours by the Bidwell-Sterling distillation method. The beans should be ground in a rugged grinder such as is used for ores or minerals.





## CHAPTER XXV

### PHARMACOLOGY OF THE COFFEE DRINK

BRIEF DISCUSSION OF THE PHYSICAL AND MENTAL EFFECTS OF COFFEE DRINKING, WITH DIGEST OF SCIENTIFIC OPINIONS—STIMULATING EFFECT OF CAFFEINE—COFFEE IN MODERATION IS HARMLESS TO MOST PEOPLE—COFFEE AND INSOMNIA—PHYSIOLOGICAL AND MENTAL REACTIONS—CAFFEINE A NON-HABIT FORMING SUBSTANCE—INDIVIDUAL CAFFEINE TOLERANCE—NON-CUMULATIVE ACTION OF CAFFEINE IN THE HUMAN SYSTEM—MENTAL AND MOTOR EFFICIENCY TESTS BY HOLLINGWORTH, WITH TABULATION OF RESULTS

By DR. S. C. PRESCOTT

Dean of Science and Head of the Department of Biology and Public Health, Massachusetts Institute of Technology, Cambridge, Mass.

THE literature dealing with the effect of coffee-drinking on the consumer, or what might be called its physiological and pharmacological aspects, is voluminous. Historically, it goes back to the ninth century, when coffee drinking first began to extend from Abyssinia and Arabia into other parts of the Eastern Hemisphere. From that time, interest has been expressed, and opinions—not always reached by logic or consistent observation—have been expressed. In 1923 a survey of the literature of coffee showed that of 671 articles reviewed, 447 dealt with some phase of its physiologic effect; while less than 50 dealt with its chemical composition and analysis, and less than 10 with the technical problems of roasting. The literature of the past ten years shows a similar distribution of interest. Such a review as the one mentioned leaves one in doubt as to the soundness and real authority of much of the published work on the pharmacology of coffee, since diametrically opposed opinions are encountered in some cases, while in others the opinion has been reached as a result of observations on a single individual or on very small groups of individuals not in a state of normal health. The existing contradiction of opinion must, therefore, be recognized in any attempt to arrive at generalizations regarding the physiological effects of coffee. Nevertheless, if

one examines the methods of research, the attempts of investigators to reduce experimental error to the lowest possible terms, and to secure comparative data in sufficient volume to warrant the drawing of specific conclusions, broad generalizations can be made.

The use of coffee as a daily table beverage is widespread throughout both North and South America, much of Europe and civilized Africa, and in western Asia, the East and West Indies, and Australasia. Coffee is probably the most widely used of all hot beverages. Broadly speaking it seems to have met a natural necessity, or at least to have fulfilled a natural desire on the part of many millions of people. In certain nations its use is so extensive as to be almost universal, like some parts of South America—while in other countries it may be replaced in part by tea or cocoa. Comparative statistics give no reason to draw conclusions that these beverages are damaging to any people as a whole, and pharmacological data must therefore be derived from the experience of individuals and of groups which can be observed in detail.

It is recognized that the actual food value of coffee, as brewed from the roasted and ground seed, is practically nil, and that it belongs to the class of auxiliary substances, used as a concomitant to food, or

because of its own pleasing effect as a hot drink—or in warm weather as a cooling one—or because of its aroma and flavor, or because of its stimulating effect upon the central nervous and vascular systems.

The characteristic flavor and aroma are due to small quantities of aromatic and volatile products brought about largely by roasting, while the stimulating effect and, in general, the physiological action, mainly depends upon the presence of caffeine. This substance imparts no odor or flavor, hence it is possible to prepare coffees from which the active principle has been extracted and which may still possess to a large degree the characteristic odor and flavor.

#### *The Stimulating Effect of Caffeine*

Caffeine is a remarkable stimulant to the central nervous system with the ordinary dosage supplied by moderate amounts of coffee. It produces a mild exhilaration—a feeling of buoyancy and well being—and its use is not followed by a depression, either mental or physical. Acting through the nervous mechanism it increases the pulse rate, lightens the sense of fatigue and makes possible sustained or prolonged muscular exertion. Its value in this respect has been demonstrated by the experience of the Arctic and Antarctic explorers, and by those exposed to hardship under many and varied conditions. In tropical countries it stimulates the action of the skin, promoting perspiration and consequent cooling sensations caused by evaporation. Acting on the brain centers, it makes the consumer alert and wide awake, stimulates imagination, increases mental activity, and quickens the perceptions. Thus it assists in a clear and precise flow of thoughts, and makes possible sustained intellectual work without any obvious depressive after-effects. These effects are recognized by students, writers and artists, as well as by those engaged in muscular work. There are, however, a great many individual differences in caffeine tolerance and in the quickness of response to caffeine.

The action on the heart is twofold, for while it tends to increase the rate and strength of the heart-beat by direct action on the heart muscle, a counter effect is produced by the stimulation of the inhibitory center in the medulla.<sup>1</sup>

<sup>1</sup> Niles, G. M. *Tea and Coffee Trade Jour.* (Vol. XIX, No. 1, p. 27).

Coffee is a marked diuretic, the action of the caffeine on the kidneys promoting its excretory functions. Coffee is also said to aid digestion by stimulating a slightly increased secretion of hydrochloric acid, and by reacting favorably on intestinal peristalsis.

#### *Coffee in Moderation Harmless*

The fact that coffee—or caffeine—brings about such a marked stimulation of the heart and of the central nervous system, with the attendant phenomena, seems to be the basis for such disagreement as exists among medical authorities. A study of the literature leads to the observation that the majority of opinion is strong that coffee taken in moderation is without harmful effect. It therefore becomes in part a question of quantity. Just what constitutes moderation depends on the individual, on the strength of the infusion consumed, and on its method of preparation. Careful study has brought out the interesting fact that with coffee, as with numerous other articles of food, there are personal or individual idiosyncrasies; that a small percentage of the population responds unfavorably to caffeine stimulation, and a still smaller percentage cannot use coffee without unfavorable results, although they may be able to drink tea which also contains caffeine, and vice versa. This recognition of specialized behavior in a few instances—probably not more than one per cent of the adult population—gives us a basis by which we may explain the diverse opinions which have arisen.

Pages could be filled with quotations from writers who have expressed opinions, favorable or adverse, on the desirability of coffee as a beverage. But few of them are here reproduced since the same arguments constantly repeat themselves, and special cases, sometimes cited, too often have pertinent facts obscured by conditions which make logical deduction impossible. However, a few authoritative statements are of interest as presenting the different viewpoints.

The late Dr. Harvey W. Wiley, former Chief of the Bureau of Chemistry, Department of Agriculture, was well known as antagonistic to the use of coffee. Without submitting definite evidence he states:

The effects of the excessive use of coffee, tea, and the other natural caffeine beverages is well

known. Although the caffeine is combined in these beverages naturally, and they are as a rule taken at meal times, which mitigates the effects of the caffeine, they are recognized by every one as tending to produce sleeplessness, and often indigestion, stomach disorders, and a condition which, for lack of a better term, is described as nervousness. . . The excessive drinking of tea and coffee is acknowledged to be injurious by practically all specialists.

It should also be noted that he deals only with the *excessive* use of coffee. On the other hand, the public is interested in the ordinary or general use as practiced by the majority of consumers. If coffee is prejudicial to the health of the general population it certainly should be made known. Search for the reports of unbiased research leading to such a conclusion fails to bring to light any important and convincing documentary evidence. On the other hand, many expressions of opinion presenting the opposite view are available. Thus the late Dr. V. C. Vaughan, who was Dean of the Medical School of the University of Michigan, speaking of tea and coffee, expresses this opinion:

I believe that caffeine used as a beverage and in moderation not only is harmless to the majority of adults, but is beneficial.

This verdict is upheld by the results of a symposium<sup>2</sup> conducted by the *Medical Times*, in which a large majority of the medical experts participating, among whom may be enumerated Drs. Lockwood, Wood, Hollingworth, Robinson, and Barnes, agreed that the drinking of coffee is not harmful per se, but that over-indulgence is the real cause of any ill effects. This is also true of any ingested material.

#### *Coffee and Insomnia*

Insomnia is a condition frequently attributed to coffee, but that the authorities disagree on this ground is shown by Wiley's<sup>3</sup> contention, "We know beyond doubt that the caffeine (in coffee) makes a direct attack on the nerves and causes insomnia"; while Woods Hutchinson<sup>4</sup> observes:

Oddly enough, a cup of hot, weak tea or coffee, with plenty of cream and sugar, will often help you to sleep, for the grateful warmth and stimulus to the lining of the stomach,

<sup>2</sup> *Tea and Coffee Trade Journal*. (Vol. XXIV: p. 455.)

<sup>3</sup> *Tea and Coffee Trade Journal*. (Vol. XXIII: p. 356.)

<sup>4</sup> *Good Housekeeping*, through *Tea and Coffee Trade Journal*. (Vol. XXVIII: p. 533.)

drawing the blood into it and away from the head, will produce more soothing effects than the small amount of caffeine will produce stimulating and wakeful ones.

The writer has often had people remark to him that while black coffee sometimes kept them awake, coffee with cream or sugar or both made them drowsy.

Carl V. Voit,<sup>5</sup> the German physiological chemist, also accepted this view, for he wrote:

The effect of coffee is that we are bothered less by unpleasant experiences and become more able to conquer difficulties; therefore, for the feasting "rich," it makes intestinal work after a meal less evident and drives away the deadly ennui; for the student it is a means to keep wide awake and fresh; for the worker it makes the day's fatigue more bearable.

#### *Physical and Mental Effects*

Dr. Woods Hutchinson<sup>6</sup> made an exhaustive study of the effect of coffee drinking, the results of which appeared in an excellent popular article written in his able and fact finding manner. He says:

Somewhere from 1 to 3 per cent of the community are distinctly injured or poisoned by tea or coffee, even small amounts producing burning of the stomach, palpitation of the heart, headache, eruptions of the skin, sensations of extreme nervousness, and so on; though the remaining 97 per cent are not injured by them in any appreciable way if consumed in moderation.

The psychological studies which were conducted by Dr. H. L. Hollingworth of Columbia University constitute one of the most discriminating pieces of investigation ever done on this subject. He conducted, over a period of several months, investigations on the influence of caffeine on various kinds of psychological and mechanical tests, where the reaction of the subject could be accurately measured and the effect readily interpreted. These tests were conducted on a great variety of individuals of all classes and ages, with the exception of children, and constitute a very useful contribution to the knowledge of caffeine, as well as providing an outline for a method of experimentation which has been very largely freed from objections and difficulties. We feel therefore that the conclusions presented by Hollingworth are well worth consideration not merely in scientific or psychological circles but also in

<sup>5</sup> *Handbuch der Physiologie*, 1881. (Vol. VI: p. 435.)

<sup>6</sup> *Tea & Coffee Trade Jour.* (Vol. XXVII: p. 586.)

their general bearing on the use and abuse of coffee. Some of his findings are summarized in the following statements:

The subjects quite uniformly reported improvement in health, spirits and general efficiency at the close of experiment. This is perhaps due to the regular régime of life followed during the 40 days. Those who had given up the use of caffeine-containing beverages during the experiment and for several days previous to its beginning do not report any craving for the drinks as such, but several expressed a feeling of annoyance at not having some sort of a warm drink for breakfast. Two subjects report a gain in weight, two a loss, and the rest either report no change or are unable to state.

The two principal factors which seem to modify the degree of the caffeine influence are body weight and the presence of food in the stomach at the time of the dose. . . There is a close correlation between the two sets of results (sleep and general health).

One of the most interesting facts shown by these experiments is the complete absence of any traces of secondary depression or of any sort of secondary reaction consequent upon the stimulation which is so strikingly present in many of the tests. Rivers' conclusion that "caffeine increases the capacity for both muscular and mental work, . . . without there being any evidence, with moderate doses, of reaction leading to diminished capacity for work," is thoroughly confirmed by the results of all the present experiments.

The widespread consumption of caffeinic beverages under circumstances in which any but individuals for whom the use of other drugs is stringently prohibited or decried seems to be justified by the results of experiment. But it should be emphasized that the results of the investigation here reported bear only on the more or less immediate effects of caffeine on performance. It is true that the investigation as a whole covered a period of 40 days, and that in the intensive experiment the effect of single doses was traced for a period of 3 days. But the results can not be carried over bodily to the question of the continuous use of the drug. One can only assume that if the constant use of caffeine in moderate amounts would prove deleterious, some indication of such effect would have shown itself in the careful study of performance in tests covering a wide range of mental and motor processes, a wide range of doses and of individuals, and of time and conditions of administration. Nor can anything be said, on the basis of these results, concerning the physiological or neurological effect of caffeine, except in so far as integrity of structure can be inferred from unimpaired function or performance.

It should be further pointed out that the quantitative results of this investigation of the influence of caffeine in its pure form can not be directly compared with the action of its citrated form, which is only half caffeine, the remainder being citric acid which itself has a demonstrable action on nerve and muscle tissue. Much the same thing is true of the action of tea, coffee, and other caffeinic beverages

which contain a variety of other substances which may be supposed to enhance or neutralize or otherwise modify the effect of the caffeine content. Many of the results commonly attributed to these beverages undoubtedly come, in so far as they can be demonstrated at all under controlled conditions, from these non-caffeine ingredients.

The second point of importance mentioned is that caffeine does not seem to draw on the "reserve." It is a well-known fact that when one does things under pressure or by the stimulation of such a psychological factor as fear, excitement or anything else which causes unusual exertion, one draws on his balance of stored up energy or what is sometimes spoken of as reserve strength. When one does things under the stimulation of caffeine, this seems not to be the case.

A third point of very great importance is the question of the habit-forming character of substances which are used for stimulation. For the average adult caffeine is not a habit-forming substance. Its use does not develop a slavish tendency or produce moral irresponsibility. To be sure, there are many people, perhaps the majority of people, who have acquired the habit of drinking coffee in the same way that they have acquired the habit of having a cereal for breakfast, or putting butter on their bread or toast or rolls, or doing other simple things in the matter of regularity of diet. We can, therefore, differentiate between simple habits of this sort and pernicious habits, such as the use of cocaine or morphine.

#### *Caffeine Is Not Habit Forming*

The so-called habit-forming drugs have as outstanding results the following tendencies, first, the necessity for gradually increasing the quantities in order to produce the same physiological effect. A cocaine or morphine addict, for example, may begin by using as small an amount as a quarter of a grain, but it is very soon found that this amount will not produce the physiological effect which is desired. The tendency is therefore to increase the dose gradually until it may be that such an addict takes daily enormous doses, possibly as high as two hundred grains, an amount which, if taken before tolerance to the drug has been acquired, would either produce severe symptoms or might even prove fatal. In fact, the large doses would prove to be fatal unless vomiting or other symptoms

were induced which would cause the body to throw them off before fatal action could take place.

A second characteristic of these habit-forming compounds is that there is developed a craving which becomes practically a disease, and which produces a dulling of the normal mental processes to the detriment of will power, and may seriously interfere with the normal physiological processes of the body.

These two phenomena are practically constant in all cases where truly habit-forming substances are employed. This, in some instances may be made a matter of degree, as for example in the case of the use of alcohol, where the casual user takes a small quantity for taste or flavor or for the social pleasures which may be associated. If, on the other hand, it is habitually taken in excess for the purposes of producing drunkenness, it becomes a pernicious rather than a simple habit.

With caffeine or with caffeine-containing beverages no such train of dangerous circumstances is involved. The user of coffee does not find, as time goes on, that he demands more and more to get the same degree of satisfaction. In fact there is possibly a tendency the other way. It is certainly true that those who have been using the beverage for many years find themselves entirely satisfied with the one or two cups at breakfast to which they have been accustomed over a long period of time. The same is true in those instances where caffeine itself rather than a caffeine-containing beverage, like tea or coffee, is employed. It may be stated therefore that for the average adult caffeine is not a habit-forming substance, nor does it have a cumulative effect on the system. It is not stored up in the body until a general breakdown of the nervous system ensues nor is there any evidence that it tends to cause kidney troubles.

#### *Individual Caffeine Tolerance*

That there is a marked difference in caffeine tolerance among different individuals is well known. Certain highly organized, sensitive individuals may be easily affected by small quantities and secure the characteristic stimulation by very small amounts either in pure form or when taken as coffee or tea. There are doubtless individuals whose nervous systems have such marked irritability as to make it undesir-

able to use any form of stimulation. Others, on the other hand, have a marked caffeine tolerance and can utilize comparatively large quantities without any of the symptoms or sensations of over-stimulation.

The average cup of strong coffee contains approximately one and one-half to one and three-quarters grains of caffeine, an amount which in some instances is ample to give a quicker heartbeat and a more pronounced mental activity. With others two or three times or even four or five times this amount may not cause any greater degree of stimulation.

It must be recognized that in the use of a beverage such as coffee the individual tolerance as well as the individual taste plays an important part. The writer knows a vigorous man in middle life, also a physician, who as a tea and coffee drinker has for years used the equivalent of nine to ten grains of caffeine daily, with no trace of excessive stimulation and absolutely no undesirable after effects. This is probably not an unusual record, as there are undoubtedly large numbers of people who use tea and coffee even more freely than he does, who are entirely normal in their activities, and have not suffered in any degree from the use of the beverage. The citation of such individual cases, however, does not constitute an argument for or against the use of caffeine-containing beverages, and has not been made for that purpose, but to illustrate low and high caffeine-tolerance among sound individuals of the same general group and profession.

If it is found that an individual is especially sensitive to tea or coffee, its use except in extremely limited amount is not to be recommended. But in such case the abnormality may be in the individual rather than in any inherent deleterious property of the caffeine itself. That excessive amounts of caffeine may incite disturbances in the central nervous system of any normal individual temporarily is well recognized, and is not to be wondered at. It is equally true that other normally harmless substances which we use daily, such as salt, sugar, or condiments, may also produce untoward symptoms that are often severe, if excessive amounts are employed.

It is also well established that pure caffeine and coffee do not necessarily affect the individual in exactly the same manner. Numerous instances are known, in which coffee cannot be used freely, or even in



small amounts, while caffeine in its pure form may be used. There is also a fairly numerous group of persons who can use tea but not coffee, although both contain caffeine as the stimulating agent. There are a number of reasons possible for this, most important of which is perhaps that other ingredients in coffee have a pronounced physiological effect, especially when the coffee is not properly prepared. Just how far we can go in deciding what these ingredients are is not entirely clear at the present time.

#### *Non-Cumulative Action of Caffeine*

In the 1922 edition of *All About Coffee*, Trigg summarized the literature dealing with the cumulative action of caffeine, and gave an account of the various investigations by Hollingworth and others on the relation of caffeine to mental and motor efficiency and to fatigue. These investigations are recognized as the outstanding contributions to this field, and in spite of the lapse of more than one decade their conclusions are still the most authoritative and reliable. On both these matters therefore, the excellent review of Trigg is quoted in full:

Regarding the alleged cumulative action of caffeine, Pletzer,<sup>7</sup> Liebreich,<sup>8</sup> Szekacs,<sup>9</sup> Pawinski,<sup>10</sup> and Seifert,<sup>11</sup> all concluded from their investigations that the action of caffeine is usually of brief duration, and does not have a cumulative effect, because of its rapid elimination; so that there is no danger of intoxication.

Dr. Oswald Schmiedeberg says:

Caffeine is a means of refreshing bodily and mental activity, so that this may be prolonged when the condition of fatigue has already begun to produce restraint, and to call for more severe exertion of the will, a state which, as is well known, is painful or disagreeable. This advantageous effect, in conditions of fatigue, of small quantities of caffeine, as it is commonly taken in coffee or tea, might, however, by continued use become injurious, if it were in all cases necessarily exerted; that is to say, if by caffeine the muscles and nerves were directly spurred on to increased activity. This is not the case, however, and just in this lies the peculiarity of the effect in question. The muscles and the simultaneously-acting nerves only under the influence of caffeine respond more easily to the impulse of the will, but do not develop spontaneous activity; that is, without the cooperation of the will.

The character of caffeine action makes plain that these food materials do not injure the organism by their caffeine content, and do not by continued use cause any chronic form of illness.

According to Dr. Hollingworth's<sup>12</sup> deductions, caffeine is the only stimulant that quickens the functions of the human body without a subsequent period of depression. His explanation for this behavior is that "caffeine acts as a lubricator for the nervous system, having an actual physical action whereby the nerves are enabled to do their work more easily. Other stimulants act on the nerves themselves, causing a waste of energy, and consequently, according to nature's law, a period of depression follows; and the whole process tends to injure the human machine." In not a single instance during his experiments at Columbia University did depression follow the use of caffeine.

Of course, caffeine, like any other alkaloid, if used to excess will prove harmful, due to the over-stimulation induced by it. However, taken in moderate quantities, as in coffee and tea by normal persons, the conclusions of Hirsch<sup>13</sup> may be taken as correct, namely: caffeine is a mild stimulant, without direct effect on the muscles, the effect resulting from its own destruction and being temporary and transitory; it is not a depressant either initially or eventually; and is not habit-forming but a true stimulant, as distinguished from sedatives and habit-forming drugs.

#### *Caffeine and Mental and Motor Efficiency*

The literature on the influence of caffeine on fatigue has been summarized, and the older experiments clearly pointed out, by Rivers.<sup>14</sup> A summary of the most important researches which have had as their object the determination of the influence of caffeine on mental and motor processes has been made by Hollingworth,<sup>15</sup> from whose monograph much of the following material has been taken.

Increase in the force of muscular contractions was demonstrated in 1892 by De Sarlo and Barnardini<sup>16</sup> for caffeine and by Kraepelin for tea. These investigators used the dynamometer as a measure of the force of contraction; however, most of the subsequent work on motor processes has been by the ergographic method. Ugolino Mosso,<sup>17</sup> Koch,<sup>18</sup> Rossi,<sup>19</sup> Sobieranski,<sup>20</sup> Hoch and Kraepelin,<sup>21</sup> Destree,<sup>22</sup> Benedicenti,<sup>23</sup> Schumberg,<sup>24</sup> Hellsten,<sup>25</sup> and Jo-

<sup>12</sup> *New York Herald*, Mar. 24, 1912.

<sup>13</sup> *Tea and Coffee Trade Jour.*, 1914 (Vol. XXVI: pp. 537-41).

<sup>14</sup> *The Influence of Alcohol and Other Drugs on Fatigue*.

<sup>15</sup> "The Influence of Caffeine on Mental and Motor Efficiency." *Archives of Psychology*, 1912 (No. 22).

<sup>16</sup> *Revista sper. di Freniatria* (Vol. XVIII: p. 1).

<sup>17</sup> *Archiv. ital. de Biol.*, 1893 (Vol. XIX: p. 241).

<sup>18</sup> *Inaug. Diss.*, Marburg, 1894.

<sup>19</sup> *Revista sper. di Freniatria*, 1894 (Vol. XX: p. 458).

<sup>20</sup> *Centralbl. f. Physiol.*, 1896 (Vol. X: p. 126).

<sup>21</sup> *Psychol. Arbeit.*, 1896 (Vol. I: p. 378).

<sup>22</sup> *Jour. Med. de Bruxelles*, 1897.

<sup>23</sup> *Moleschott's Untersuchungen*, 1899 (Vol. XVI: p. 170).

<sup>24</sup> *Archiv. f. Anat. u. Physiol.* (Physiol. Abth.), Suppl. Bd., 1899 (p. 289).

<sup>25</sup> *Skand. Arch. f. Physiol.*, 1904 (Vol. XVI: p. 197).

<sup>7</sup> *Berliner Klin. Wochenschrift*, 1889 (No. 40).

<sup>8</sup> *Encyc. der Therapie*, 1896 (Vol. I).

<sup>9</sup> *Pester, Med.-Chir. Presse*, 1885 (No. 39). Orvosi

*Hetlap*, 1885 (Nos. 32-33).

<sup>10</sup> *Zeitschrift f. Klin. Med.*, 1893 (Vol. XXIII).

<sup>11</sup> *Mitt. aus der Würzburger Med. Klinik*, 1885 (Vol. I).

teyko,<sup>26</sup> have all observed a stimulating effect of caffeine on ergographic performance. Only one investigation of those reported by Rivers failed to find an appreciable effect, that of Oseretzkowsky and Kraepelin,<sup>27</sup> while Fere<sup>28</sup> affirms that the effect is only an acceleration of fatigue.

In spite of the general agreement as to the presence of stimulation there is some dissension regarding whether only the height of the contractions or their number or both are affected. As might be expected from the great diversity of methods employed, the quantitative results also have varied considerably. Carefully controlled experiments by Rivers and Webber<sup>29</sup> "confirm in general the conclusion reached by all previous workers that caffeine stimulates the capacity for muscular work; and it is clear that this increase is not due to the various psychical factors of interest, sensory stimulation, and suggestion, which the experiments were especially designed to exclude. The greatest increase . . . falls, however, far short of that described by some previous workers, such as Mosso; and it is probable that part of the effect described by these workers was due to the factors in question."

Investigations of mental processes under the influence of caffeine have been much less frequent, most notable among which are those of Dietsch and Vintschgau,<sup>30</sup> Dehio,<sup>31</sup> Kraepelin and Hoch,<sup>32</sup> Ach,<sup>33</sup> Langfeld<sup>34</sup> and Rivers.<sup>35</sup> Kraepelin<sup>36</sup> observes: "We know that tea and coffee increase our mental efficiency in a definite way, and we use these as a means of overcoming mental fatigue. . . . In the morning these drinks remove the last traces of sleepiness and in the evening when we still have intellectual tasks to dispose of they aid in keeping us awake." Their use induces a greater briskness and clearness of thought after which secondary fatigue is either entirely absent or is very slight.

Tendency toward habituation of the psychic functions to caffeine has been studied by Wedemeyer<sup>37</sup> who found that in the regular administration of it in the course of four to five weeks there is a measurable weakening of its action on psychic processes.

Rivers<sup>38</sup> who seems to have been the first to appreciate fully the genuine and practical importance of thoroughly controlling the psychological factors that are likely to play a role in such experiments, concludes that "caffeine

increases the capacity for both muscular and mental work, this stimulating action persisting for a considerable time after the substance has been taken without there being any evidence, with moderate doses, of reaction leading to diminished capacity for work, the substance thus really diminishing and not merely obscuring the effects of fatigue."

Subsequent to these investigations was that of Hollingworth<sup>39</sup> which is at once the most comprehensive, carefully conducted and scientifically accurate one yet performed. He employed an ample number of subjects in his experimentation; and both his subjects, and the assistants who recorded the observations, were in no wise cognizant of the character or quantity of the dose of caffeine administered, the other experimental conditions being similarly rigorous and extensive.

The purpose of his study was to determine both qualitatively and quantitatively the effect of caffeine on a wide range of mental and motor processes by studying the performance of a considerable number of individuals for a long period of time, under controlled conditions; to study the way in which this influence is modified by such factors as the age, sex, weight, idiosyncrasy, and previous caffeine habits of the subjects, and the degree to which it depends on the amount of the dose and the time and conditions of its administration; and to investigate the influence of caffeine on the general health, quality and amount of sleep, and food habits of the individual tested.

To obtain this information the chief tests employed were the steadiness, tapping, coordination, typewriting, color-naming, calculations, opposites, cancellations, and discrimination tests, the familiar size-weight illusion, quality and amount of sleep, and general health and feeling of well-being. A brief review of the results of these tests is given in the tabular summary.

From these Hollingworth concluded that caffeine influenced all the tests in a given group in much the same way. The effect on motor processes comes quickly and is transient, while the effect on higher mental processes comes more slowly and is more persistent. Whether this result is due to quicker reaction on the part of the motor-nerve centers, or whether it is due to a direct peripheral effect on the muscle tissue is uncertain, but the indications are that caffeine has a direct action on the muscle tissue, and that this effect is fairly rapid in appearance. The two principal factors which seem to modify the degree of caffeine influence are body weight and presence of food in the stomach at the time of ingestion of the caffeine. In practically all of the tests the magnitude of the caffeine-influence varied inversely with the body weight, and was most marked when taken on an empty stomach or without food substance. This variance in action was also true for both the quality and amount of sleep, and seemed to be accentuated when taken on successive days; but it did not appear to depend on the age, sex, or previous caffeine habits of the individual. Those who had given up the use of

<sup>26</sup> *Travaux du Lab. de Physiol. Inst. Solvay*, 1904 Vol. VI: p. 361).

<sup>27</sup> *Psychol. Arbeit.*, 1901 (Vol. III: p. 617).

<sup>28</sup> *C. R. de la Soc. de Biol.*, Paris, 1901 (pp. 593-627).

<sup>29</sup> *The Influence of Alcohol and Other Drugs on Fatigue*.

<sup>30</sup> *Pflügers Archiv.*, 1877 (Vol. XVI: p. 316).

<sup>31</sup> *Diss.*, Dorpat., 1877.

<sup>32</sup> *Psychol. Arbeit.*, 1896 (Vol. I: p. 431).

<sup>33</sup> *Psychol. Arbeit.*, 1901 (pp. 203-289).

<sup>34</sup> *Psychol. Rev.*, 1911 (Vol. XVIII: p. 424).

<sup>35</sup> *The Influence of Alcohol and Other Drugs on Fatigue*.

<sup>36</sup> *Ueber die Beeinflussung einfacher psychischer Vorgänge durch einige Arzneimittel* (p. 224).

<sup>37</sup> *Arch. exp. Path. Pharm.*, 1920 (Vol. LXXXV: pp. 339-58).

<sup>38</sup> *The Influence of Alcohol and Other Drugs on Fatigue*.

<sup>39</sup> *New York Herald*, March 24, 1912.

EFFECT OF CAFFEINE ON MENTAL AND MOTOR PROCESSES  
Schematic Summary of All Results

St. = Stimulation. O = No. effect. Ret. = Retardation

Process	Tests	PRIMARY EFFECT			Secondary Reaction if any	Action Time Hours	Duration in Hours
		Small Doses	Medium Doses	Large Doses			
Motor Speed Coordination	1. Tapping .....	St.	St.	St.	None	.75—1.5	2—4
	2. Three-hole .....	St.	O	Ret	None	1 —1.5	3—4
Association	3. Typewriting (a) Speed .....	St.	O	Ret	None	Results shown only in total day's work	
	(b) Errors .....	Fewer for all doses			None	2 —2.5	3—4
	4. Color-naming .....	St.	St.	St.	None	2.5 —3	Next Day
Choice	5. Opposites .....	St.	St.	St.	None	2.5 —	Next Day
	6. Calculation .....	St.	St.	St.	None	2 —4	Next Day
General	7. Discrimination reaction time.	Ret	O	St.	None	3 —5	No data
	8. Cancellation .....	Ret	?	St.	None	2 —	No data
General	9. S-W illusion .....	O	O	O	None	1 —3	3—4
	10. Steadiness .....	?	Unsteadiness		None	1 —3	3—4
	11. Sleep quality .....	Individual differences de-				2 ?	
	12. Sleep quantity .....	pending on body weight and					
	13. General health .....	conditions of administration					

caffeine-containing beverages during the experiment did not report any craving for the drinks as such, but several expressed a feeling of annoyance at not having some sort of a warm drink for breakfast.

It is interesting to note that he also found a complete absence of any trace of secondary depression or of any sort of secondary reaction consequent upon the stimulation which was so strikingly present in many of the tests. The production of an increased capacity for work was clearly demonstrated, the same being a genuine drug effect, and not merely the effect of excitement, interest, sensory stimulation, ex-

pectation or suggestion. However, this study does not show whether this increased capacity comes from a new supply of energy introduced or rendered available by the drug action, or whether energy already available comes to be employed more effectively, or whether fatigue sensations are weakened and the individual's standard of performance thereby raised. But they do show that from a standpoint of mental and productive physical efficiency "The widespread consumption of caffeinic beverages, except by individuals from whom the use of other drugs is stringently prohibited or decried, is justified."

THE HEALTHFULNESS OF COFFEE

A DIGEST OF SCIENTIFIC, MEDICAL, AND POPULAR OPINIONS BY COMPETENT AUTHORITIES COLLECTED BY THE AUTHOR FROM NEWSPAPERS, PERIODICALS, AND WORKS OF KNOWN STANDING AND RESPONSIBILITY

SO MANY things that are not so have been published about coffee that it has been deemed expedient to assemble in one place many of the best answers to such intolerances as have persisted since the early days of the beverage, together with a few notable observations by authorities who ought to know whereof they speak, when coffee is the subject. These in addition to the authorities quoted by Dr. Prescott in the foregoing chapter.

Coffee Bugaboos

Recent scientific research has destroyed many bugaboos manufactured by the tra-

ducers of our national beverage; for one, the alleged harmful effects of the caffeine content. We now know that the small amount of caffeine in the coffee cup is distinctly beneficial to the majority and that it is a pure stimulant having no harmful reaction.

Then there was the notion that cream in coffee made the beverage indigestible. The statement was made that milk or cream caused the coffee liquid to become coagulated when it came into contact with the acids of the stomach. This is true, but it does not carry with it the inference that indigestibility accompanies this coagulation. Milk and cream, upon reaching the

stomach, are coagulated by the gastric juice, but the casein product formed is not indigestible. These liquids, when added to coffee, are partly acted upon by the small acid content of the brew, so that the gastric juice action is not so pronounced, for the coagulation was started before ingestion, and the coagulable constituent, casein, is more dilute in the cup as consumed than it is in milk. Accordingly, the particles formed by it in the stomach will be relatively smaller and more quickly and easily digested than milk *per se*.

#### *Coffee Enlightenment*

Before the campaign of education conducted by coffee men in the United States, many neurotics received with gladness the tales of the harmfulness of coffee. They eagerly welcomed the doubtful substitutes, coffee minus the caffeine, or some nauseating cereal preparation. They were convinced that by avoiding coffee they could cure their nervous condition.

A leading New York medical journal expressed the general opinion when it said:

This whole question has been exaggerated. Coffee in moderation does not produce nervous ailments. Removal of coffee from the diet does not cure them. Coffee with cream and sugar is a source of food and energy. In many cardiac and nephritic conditions there is no better or simpler preparation than well prepared coffee.

It is amusing to see chocolate, cocoa, and even tea substituted for coffee in various nervous or other conditions, when, as a matter of fact, the amount of stimulus cup for cup is the same or even greater. What foundation there is for giving children and old persons various chocolate preparations in place of coffee is difficult to determine.

It would be well to look at the coffee question squarely and not cover the situation by inane avoidances. Coffee is one of the mainstays of our rapid civilization. Those adults who wish to live and enjoy life, let them drink their coffee in peace. Those who wish to ascribe illness or nervousness to magical causes, let them abandon it.—*New York Medical Journal & Medical Record*, April 18, 1923.

#### *The Whole Truth About Coffee*

For more than three years the Massachusetts Institute of Technology made an exhaustive investigation of coffee. This investigation was made at the invitation of the coffee trade of the United States to determine by scientific research the whole truth about coffee and coffee making. It involved a total cost of \$40,000 and was

one of the most thorough investigations ever made of any food product.

The result of this scientific research, as announced by Professor Samuel C. Prescott, head of the Institute's Department of Biology and Public Health, shows that coffee is a wholesome, helpful, satisfying drink for the great majority of people.

The report covers many hundreds of pages, for every aspect of coffee and coffee making was studied, but in just one paragraph of 92 words Professor Prescott swept aside all the old prejudices and superstitions, and gave coffee the cleanest bill of health that could be wished. He said:

It may be stated that, after weighing the evidence, a dispassionate evaluation of the data so comprehensively surveyed has led to no alarming conclusions that coffee is an injurious beverage for the great mass of human beings, but, on the contrary, that the history of human experience, as well as the results of scientific experimentation, point to the fact that coffee is a beverage which, properly prepared and rightly used, gives comfort and inspiration, augments mental and physical activity, and may be regarded as the servant rather than the destroyer of civilization.

#### SCIENTIFIC AND MEDICAL OPINIONS

While scientific and medical men are not always unqualified in their approval of coffee, it is astonishing how much agreement there is among them concerning the general healthfulness of coffee drinking for normal individuals. Witness the following exhibits collected from authoritative sources:

#### *A Most Valuable Drink*

Dr. Valentin Nalpasse, of the Faculty of Medicine of Paris, states:

When coffee is properly made and taken in moderation, it is a most valuable drink. It facilitates the digestion because it produces a local excitement. Its principal action gives clear and stable imaginative power to the brain.—*Tea & Coffee Trade J'n'l*, June, '06 (p. 303).

#### *Coffee, A Nerve Food*

Dr. Jonathan Hutchinson says:

Tea and coffee arouse the dull, calm the excitable, prevent headaches, and fit the brain for work. They preserve the teeth, keep them in their place, strengthen the vocal chords, and prevent sore throat. To stigmatize these invaluable articles of diet as "nerve stimulants" is an erroneous expression, for they undoubtedly have a right to rank as nerve nutrients.—*Tea and Coffee Trade Journal*, July, 1911 (p. 36).

*Coffee Not Habit-Forming*

Dr. J. W. Mallet, testifying before a Federal Court, stated that caffeine and coffee were not habit-forming in the correct sense of the term. His definition of the expression is that the habit formed must be a detrimental and injurious one—one which becomes so firmly fixed upon a person forming it that it is thrown off with great difficulty and with considerable suffering, continuous exercise of the habit increasing the demand for the habit-forming drug. It is well known that the desire ceases in a very short period of time after cessation of use of caffeine-containing beverages, so coffee is not habit-forming.—*Tea and Coffee Trade Journal*, June, 1914 (p. 539).

*Coffee Fixations*

Dr. Brady believes that the so-called harmfulness of coffee is mainly psychological, as evidenced by his expression:

Most of the prejudice which exists against coffee as a beverage is based upon nothing more than morbid fancy. People of dyspeptic or neurotic temperament are fond of assuming that coffee must be bad because it is so good, and, accordingly, denying themselves the pleasure of drinking it.—*The Coffee Club*, 1921 (vol. i:p. 4).

The recounting of evidence, both pro and con, relevant to the general effects of coffee could continue almost *ad infinitum*, but the fairest unification of the various opinions is best quoted from Woods Hutchinson in Dr. Prescott's preceding chapter. It is that only 3 per cent of individuals may be harmed; 97 per cent are not injured.

So, if one is personally satisfied that he belongs to the abnormal minority, and has not been argued by fallacious reasoning into his belief that coffee injures him, he should either reduce his consumption of coffee or let it alone. Even those most vitally interested in the commercial side of coffee will admit that this is the logical procedure.

*Coffee Drinking and Longevity*

There are many who would have us believe that the use of coffee is only a means toward the end of quickly reaching the great beyond; but it is known that the habitual coffee drinker generally enjoys good health, and some of the longest-lived

people have used it from their earliest youth without any apparent injury to their health. Nearly every one has an acquaintance who has lived to a ripe old age despite the use of coffee. Quoting Metchnikoff:

In some cases centenarians have been much addicted to the drinking of coffee. The reader will recall Voltaire's reply when his doctor described the grave harm that comes from the abuse of coffee, which acts as a real poison. "Well," said Voltaire, "I have been poisoning myself for nearly eighty years." There are centenarians who have lived longer than Voltaire and have drunk still more coffee. Elizabeth Durieux, a native of Savoy, reached the age of 114. Her principal food was coffee, of which she took daily as many as forty small cups. She was jovial and a boon table companion, and used black coffee in quantities that would have surprised an Arab. Her coffee-pot was always on the fire, like the tea-pot in an English cottage (Lejoncourt, p. 83; Chemin, p. 147).—*The Prolongation of Life*.

The entire matter resolves itself into one of individual tolerance, resistivity, and constitution. Numerous examples of young abstainers who have died and coffee drinkers who have still lived on can be found, and vice versa, the preponderance of instances being in neither direction. Bodies of persons killed by accident have been painstakingly examined for physiological changes attributable to coffee; but no difference between those of coffee and of non-coffee drinkers (ascertained by careful investigation of their life history) could be discerned. In the long run, it is safe to say that the effect of coffee drinking upon the prolongation or shortening of life is neutral.

*Coffee in the Alimentary Tract*

When coffee is taken *per os* it passes directly to the stomach, where its sole immediate action is to dilute the previous contents, just as other ingested liquids do. Eventually the caffeine content is absorbed by the system, and from thence on a stimulation is apparent. Considerable conjecture has occurred over the difference in the effects of tea and coffee, the most feasible explanation advanced being one appearing in the *London Lancet*.

The caffeine tannate of tea is precipitated by weak acids, and the presumption is that it is precipitated by the gastric juice and, therefore, the caffeine is probably not absorbed until it reaches the alkaline alimentary tract. In the case of coffee, however, in whatever form the caffeine may be present, it is soluble in both alkaline and acid fluids, and, therefore, the



absorption of the alkaloid probably takes place in the stomach.—*Tea and Coffee Trade Journal*, Jan., 1914 (pp. 29-32).

This theory, if true, goes far toward explaining the more rapid stimulation by coffee.

#### *Coffee in the Dietary*

The fact that coffee favors digestion without eventual disarrangement has often been argued. On the subject of the relative agreement with the constitution of foods of daily consumption, Dr. English says:

It is well known that there is no species of diet which invariably suits all constitutions, nor will that which is palatable and salutary at one time be equally palatable and salutary at another time to the same individual. I think the most natural food provided for us is milk; yet I will engage to show twenty instances where milk disagrees more than coffee.—*Tea and Coffee Trade Journal*, May, 1916 (p. 443).

Further in this regard, Hutchinson considers that ninety per cent of the "dyspepsias" attributed to coffee are due to malnutrition, or to food simultaneously ingested, no disease known to the medical profession being directly attributable to it.—*Tea and Coffee Trade Journal*, May, 1909 (p. 271).

#### *The Use of Coffee in Medicine*

Coffee has been employed in medicinal practice as a direct specific, as a preventive, and as an antidote. The *United States Dispensatory* summarizes the uses of caffeine and coffee, (p. 254, 19th edition).

Dr. Restrepo, of Medellin, Colombia, claims to have cured many cases of chronic malaria and related diseases with infusion of green coffee, after quinine had failed.—Keable, B. B. *Coffee* (p. 97).

In the Civil War, surgeons utilized coffee in allaying malarial fever and other maladies.—*Tea and Coffee Trade Journal*, Sept., 1913 (p. 239).

Dr. Guillasse, of the French Navy, recommends the use of coffee in typhoid fever.—Thurber, F. B. *Coffee from Plantation to Cup* (p. 182).

In general, the medicinal value of coffee may be said to be directly attributable to its caffeine content, although its antiseptic properties are dependent upon the volatile aromatic constituents. Its function is to raise and to sustain vitalities which have been lowered by disease or drugs. Although

some of the cures attributed to it are probably purely traditional, still, it must be admitted, that by utilizing its stimulating qualities in many illnesses the patient may plaining the more rapid stimulation by coffee.

#### *Pharmacological Conclusions*

Brief summarization of the information available on the pharmacology of coffee indicates that it should be used in moderation, particularly by children, the permissible quantity varying with the individual and ascertainable only through personal observation.

Used in moderation, it will prove a valuable stimulant increasing personal efficiency in mental and physical labor. Its action in the alimentary regime is that of an adjuvant food, aiding digestion, favoring increased flow of the digestive juices, promoting intestinal peristalsis, and not tanning any portion of the digestive organs. It reacts on the kidneys as a diuretic, and increases the excretion of uric acid,—which, however, is not to be taken as evidence that it is harmful in gout.

Coffee has been indicated as a specific for various diseases, its functions therein being the raising and sustaining of low vitalities. A few humans who are very nervous may find coffee undesirable; but sensible consumption of coffee by the average normal non-neurasthenic person will not prove harmful but beneficial.

#### *Coffee's Place in a Rational Dietary*

Answering those who condemn coffee as being harmful because it is a stimulant for the nerves, Dr. William Brady, in the *Brooklyn Eagle*, points out its place in a rational dietary:

One or two cups of coffee with or without cream and sugar for breakfast every morning must be acknowledged to be harmless for most adults, and, in my judgment, should be deemed wholesome and beneficial for most adults. This is true also of one or two cups of tea with meals every day.

The active principle of coffee is called caffeine, and a cupful of good coffee contains perhaps 1½ to 2 grains of caffeine, which is a moderate medicinal dose. The action of caffeine is identical with the action of theine. The physiological action is stimulation of the cerebrum and the spinal cord, stimulation of the heart, increasing blood pressure, stimulation of excretion through the kidneys. Stimulation of cerebrum makes you think hard and fast and tends to keep you awake. Makes lit-

tle difference whether you do it with coffee, tea, or caffeine in drug form. The refreshing effect is real—it relieves fatigue.

How much tea or coffee may you have each day? Oh, what's the use trying to name an arbitrary quantity? Suit your own taste, and as long as your health is all right, why fuss about how much you take? If there is anything the matter with your health, just ask the doctor about it next time you visit him for your health examination.

#### *Professor Prescott's Coffee Facts*

From the scientific research into the effects of coffee made by Professor Samuel C. Prescott, Head of the Department of Biology and Public Health in the Massachusetts Institute of Technology, the following summarizations are taken:

1. Coffee has a remarkable stimulating and fatigue-relieving effect. It promotes heart action mildly, increases the power to do muscular work, and increases the power of concentration in mental effort, therefore aiding sustained brain work.
2. It is not followed, except in excessive quantity, by undesirable after effects. It does not draw on the physical reserves of the body, and in general may be looked upon with no objection as a mild stimulant.
3. Caffeine is not a "drug" nor a narcotic poison. Unlike other stimulants, caffeine does not have depressing after effects. Caffeine is not habit forming.
4. All individuals do not have the same caffeine tolerance. Some with delicately organized nervous systems are highly stimulated by small quantities.
5. A few individuals have a marked coffee idiosyncrasy. For them, its use, except in extremely limited amounts, is not recommended. It should be regarded in exactly the same manner as many kinds of food—meat, shell fish, eggs, milk or fruit—which do not "agree" with one person or another.

#### *The Value of Tea and Coffee*

Dr. Martin Edwards, one of Boston's foremost authorities on preventive medicine and a specialist on dieting for health, is quoted as follows in the *Boston Post*:

I can agree that the majority of Americans are more nervous and restless than ever before, but I cannot agree that this condition can be charged to the increasing use of coffee and tea. I rather think it is largely due to what we are eating and how we are eating.

With the average individual the five grains of caffeine in one cup of coffee and the three grains in a single cup of tea constitute a reasonable and healthful physiological dose of the stimulant when mixed with food.<sup>1</sup>

Coffee is a drug, of course (I don't think Prof. Prescott denied it in his report). For that matter, this is true of all medicines and

foods. There are many stimulants habitually used by the American people. Meat is a drug, one of the most popular stimulants we have, and the one wrongly considered the least harmful. It should be taken less often than coffee.

#### *Caffeine in Coffee Not Harmful*

Dr. Daniel R. Hodgdon, one of the leading medical authorities of the country, also prominent as an instructor and lecturer, has written an analysis of the brewing of coffee and asserts that it is a "healthful and stimulating beverage."

Dr. Hodgdon says:

The proper use of coffee, unless forbidden by the physician because of some organic difficulty, is beneficial. The moderate use of coffee seems to have no marked evil effects upon a normal, healthy individual. Any normal, healthy person need not suffer from any ill effects from coffee if they do not abuse the use of it.

Dr. Oscar Dowling, president and executive officer of the Louisiana State Board of Health, says:

Coffee is an excellent and safe beverage, and because some people are adversely affected by it does not mean that the overwhelming majority are not benefited. It is simply to be used with discretion and in moderation, and obviously no harm can result.

#### *Good Words for Tea and Coffee*

In a lecture at the New York Botanical Garden, Dr. H. H. Busby, dean of the College of Pharmacy of Columbia University, speaking about tea, coffee, and cereal substitutes, said:

Tea and coffee depend for their activity on the presence of caffeine or related alkaloids. These substances are directly stimulating to cerebral activity, and stimulate all its functions. Thus, the mental equilibrium is preserved, and quantity of mental activity is increased without any sacrifice of quality.

The so-called cereal coffees are scarcely entitled to any classification here. They are merely flavored water, with a little dissolved nutrient matter, and more properly classed as weak broths.

#### *Coffee and the Digestion*

Dr. Arthur L. Holland, assistant professor of clinical medicine in Cornell University Medical College, and America's leading consultant physician on digestive diseases, says:

It is thought by many that coffee causes indigestion. This is probably not so. If one belches or is in the habit of regurgitating, the

<sup>1</sup>Dr. C. R. Harler, in *All About Tea*, estimates the caffeine content of a cup of tea as less than 1 grain and of coffee 3.5 grains.

taste of coffee, hours after it has been drunk, will be evident. This is due to the aromatic principles in the coffee; which are persistent. The same is true of many other articles of diet—cantaloupe, cauliflower, cabbage, onions, etc. These things may vary in the length of time that they remain in the stomach, but they do not cause indigestion. The fault lies in the pernicious habit of belching or regurgitating, not in these foods.

Dr. John A. Killian, of New York, recently stated at a meeting of the American Gastro-Enterological Association:

Freshly made coffee, provided that it is drunk at the conclusion of a meal, is of material assistance in the digestion of food. Such coffee contains certain valuable aromatic substances that produce a strong secretion of gastric juices that in turn stimulate food digestion.

#### *Nature's Own Pick-Me-Up*

Dr. Woods Hutchinson, writing in the *New York American*, says: "A cup of coffee with sugar is Nature's own pick-me-up; one of our best—indeed, almost our only positive or constructive heart tonic."

#### *For Neurasthenics and Hypochondriacs*

Dr. Bernhardt Aschner of the University of Vienna, one of Austria's renowned surgeons, writes:

From 15 years' experience I know that ordinary coffee results exceedingly favorably with persons with weak digestion, also in cases of neurasthenia and hypochondria, both of which often are caused by sluggish digestion, and has cured persons who had been ailing for years.

#### *For Weak and Elderly People*

Dr. A. W. Bauer, in the *Journal of Gynecology*, says:

Weak and elderly people drink coffee as one of the most natural and harmless stimulants and restoratives. Never have we seen nearly so much harm done by coffee, containing caffeine, as from nicotine or the excessive use of alcohol.

#### *Fear Thought and Coffee*

Dr. Royal S. Copeland, United States Senator and former Commissioner of the Health Department of New York City, thus addresses those who may fear they should not use coffee:

In moderate quantities coffee is an excellent beverage. Deal with coffee as you would with any other article of diet. Do not condemn it merely because it is coffee. Deal with it as you do with all other foods. Find the blend

that appeals best to your taste. Have it freshly prepared and drink it in moderation. Put aside your fears regarding it.

#### *Caffeine Not Habit-Forming*

Dr. Morris Fishbein, Editor of *The Journal of the American Medical Association* and of *Hygeia*, says:

The amount of caffeine in a cup of coffee is not habit-forming in the same sense as are opium and cocaine. The best scientific evidence indicates that, taken in moderation, coffee is not harmful. Many persons are known who have taken tea or coffee daily for 50 or 60 years without apparent ill effects.

#### *Enjoy Coffee Legitimately*

The late Alfred W. McCann, New York food expert, answering the question, "If coffee is harmful, why do you tolerate its use?" said:

If coffee is not good for you in the sense that strawberries are not good for your neighbor or cabbage is not good for your husband, by all means avoid coffee. This does not mean that strawberries and cabbages are poisons, nor does it mean that coffee is a poison. Enjoy coffee legitimately. Be moderate in your enjoyment. If you are one of the comparatively few who cannot drink it, by all means let it alone. But don't assume that the tens of thousands who find in it solace, comfort, and gentle stimulation are going to die the death by reason of their indulgence.

#### *Coffee Promotes General Well-Being*

Dr. Hugh A. McGuigan, head of the Department of Therapeutics and Pharmacology at the College of Medicine, University of Illinois, says that the general effects of caffeine (coffee) in moderate amounts are: ideas become clearer, thoughts flow more easily and rapidly, continued drowsiness disappears, intellectual efforts can be sustained longer, sensory impressions are more accurately appreciated, and ideas are better associated. Accuracy in intellectual work is greater.

#### *Coffee Induces Sleep*

Aside from his general study of coffee, we have the results of a specific study of the relation of coffee to sleep, conducted by Dr. Donald A. Laird, Ph.D., Sci.D., Director of Colgate University Psychological Laboratory, Hamilton, N. Y., and a nationally known figure in psychology studies. In summarizing the relation of coffee to sleep, Dr. Laird said:

The burden of what we have discovered about coffee is that its effect is psychological rather than physiological. That is, if a man or woman thinks that coffee will keep them awake, it will . . . that is about all there is to the coffee situation.

While Dr. Laird was making his sleep studies in the East other sleep studies were being made on the Pacific Coast by Dr. Leo L. Stanley, Prison Physician at San Quentin. He, too, found that coffee induced sleep.

#### *Stimulant and Antiseptic*

I. N. Love in the Journal of the American Medical Association says, "Coffee is a prompt diffusible stimulant, antiseptic, and encourager of elimination."

#### *Coffee Relieves Susceptibility to Noise*

In a speech before the Acoustical Society of America held in Cleveland, Ohio, Dr. Donald A. Laird of Colgate University, said:

The ordinary noises of modern American life cause serious digestive disorders which can be corrected by proper diet, including coffee. Coffee not only builds up a bodily resistance to noise, but it actually overcomes the injurious effects of many sounds to which the average person is subjected in the home and at work.

#### *No Heart Poison in Coffee*

Dr. Frederic Damrau, a physician of Brooklyn, New York, made a special analysis of statements by advertisers of coffee substitutes that coffee was injurious to the heart and reached the following conclusion:

Coffee has indeed proved one of the truest friends of mankind, helping the soldier in the field, the worker in the cold, and the thinker in the office. General experience and the technical knowledge of physicians combine to place the advertising writer's allegation that coffee poisons the heart and causes heart disease in the class of light fiction.

#### *Coffee and Alcohol*

The opposite effects of coffee and alcohol when consumed at the same time were observed by Dr. A. L. Winsor and E. I. Strongin at Cornell University in 1934. Although it had been generally assumed that coffee tends to restore mental and motor coordination in cases of alcoholic intoxication, no previous attempt seems to have

been made to investigate experimentally the antagonistic action of these drugs on human subjects.

It was found that when both alcohol and coffee are taken together there appears to be an antagonistic effect. Alcohol causes an increase in unsteadiness and a disturbance of motor coordination. Coffee showed no detrimental effect on steadiness and motor coordination over a period of two hours. The unsteadiness caused by alcohol almost disappeared when a sufficient dosage of coffee was taken immediately after the alcohol.

#### *Hygienic Aspects of Coffee*

*The Medical Journal and Record* published a 36-page summary of medical and other scientific opinions on this subject, which contained the following:

While medical opinion is divided on the subject, it would appear that the majority of authorities who have written on coffee have failed to find it noticeably harmful for the normal adult when taken in non-excessive amounts.

#### *Caffeine Supplants Digitalis*

In a recent issue of the *American Journal of Medical Science*, an article appeared concerning certain phases of angina pectoris (neuralgia of the heart) by Harlow Brooks, Emeritus Professor of Clinical Medicine, University and Bellevue Hospital Medical College, New York City. He says:

Coffee angina is much more frequent in advertising literature than in medical reports. My experience leads me to feel that in those instances in which angina appears from the abuse of, or unusual sensitization to coffee, the attacks are brought about by over-stimulation of the nervous system. I am reasonably certain also that at least some of the cases are purely imaginary.

Aside from his very pertinent observations on coffee in relation to angina, Dr. Brooks also makes a very potent observation when he refers to the possible imaginary ills and disorders that are so sensationally propagandized by certain types of advertising. It certainly holds true with certain types of anti-coffee propaganda.

Dr. Hobart A. Hare, Professor of Therapeutics, Materia Medica and Diagnosis, at Jefferson Medical College, Philadelphia, in his *Practical Therapeutics*, says: "So useful is caffeine in cases of cardiac disease

that it has largely supplanted digitalis in the hands of some practitioners."

Another authority, A. A. Stevens, Professor of Applied Therapeutics at the University of Pennsylvania, says in his *Therapeutics*: "In the circulatory failure of acute infections, such as pneumonia, influenza, typhoid fever, etc., the action of caffeine is at times superior to that of digitalis."

Oliver T. Osborne, Professor of Therapeutics at Yale University, says in his *Therapeutics*: "Caffeine is quickly absorbed and acts quickly and it should be remembered that caffeine is as well administered in the form of strong coffee as in any other way."

#### *A Litterateur on Coffee*

Dr. William Lyon Phelps, Lampson Professor of English at Yale and noted authority on English literature, answering an old-fashioned woman's inquiry, "What would a breakfast be without tea and rusk?" says:

"When I drink tea for breakfast it will be in a place where there is no coffee. If I could have only one beverage in the world besides water it would be coffee."

#### *Coffee Valuable for Athletes*

Nationally-known athletic coaches, trainers of athletes who must be at the peak of physical perfection, have impartially declared in favor of coffee. The most significant fact brought out in a recent questionnaire was the number of coaches who serve coffee to athletes between periods of contests. Included among these are such well-known football mentors as Glenn ("Pop") Warner of Leland Stanford University; Charles W. Bachman of the University of Florida; Hugo Bezkek of Pennsylvania State College, and Paul J. Schissler of Oregon State College. Mr. Schissler cited an incident in Oregon's game against New York in 1929 when "thirteen members of my football team were running temperatures with influenza. Strong, black coffee between halves stimulated them to such an extent that they were able to finish the game in good shape."

Harry A. Stuhldreher, football coach of Villanova College and quarterback of the

famous "Four Horsemen of Notre Dame," made this general statement regarding the training of athletes: "Personally, I believe growing boys should have a certain amount of coffee daily. I am in favor of serving it." Tom Keane, track coach of Syracuse University, found coffee especially valuable to competitors in field events. Many coaches asserted that coffee was extremely useful to athletes because of its mental effect, among them being Charles Whiteside, rowing coach of Harvard University, who said: "Coffee is a psychological factor in keeping the training grind from becoming too tiresome."

#### *Satisfying, Harmless and Beneficial*

Dr. Ralph H. Cheney of the Department of Biology, New York University, in a lecture on coffee and its effects at the New York Botanical Gardens, said:

For the great mass of humanity, coffee is a most satisfying, harmless and beneficially stimulating beverage.

Of the various caffeine drinks, such as coffee, tea, chocolate and cocoa, mate, cassina, coca-cola, guarana or Brazilian chocolate, etc., coffee with its delightful aroma if for no other quality, is the most satisfying of all because of the inseparable associations between the human sense of taste and smell. Defibrinated and decaffeinated coffees and coffee substitutes lack partially or entirely the aromatic qualities of coffee and therefore they cannot produce as pleasing an infusion as 100 per cent coffee.

There is also a psychological value that coffee brings about by means of its ability to cheer the spirits beyond the reaction of any other common beverage. The alkaloid caffeine is a mild brain and heart stimulant and gives relief from fatigue and hunger. Such coordination of mind and body must increase human efficiency.

#### *Coffee Good for the Heart*

In *That Heart of Yours* Dr. S. Calvin Smith corrects many fallacies regarding the use of coffee and tea and says:

Coffee is a most beneficent beverage for adult hearts. There is scarcely a person of forty or more years of age whose circulatory efficiency is not enhanced by the mild stimulation of a cup of coffee. If nourishing the heart were the only effect that coffee exerted on the human body, that would be sufficient reason for the high regard in which it is held. Its effect on the kidneys is even more desirable, as it stimulates their flow and increases the output of waste products.—*Tea & Coffee Trade Journal*, Nov., 1934 (p. 446).



**BOOK IV**  
**COMMERCIAL ASPECTS**



## CHAPTER XXVI

### HOW GREEN COFFEES ARE BOUGHT AND SOLD

BUYING COFFEE IN THE PRODUCING COUNTRIES—TRANSPORTING COFFEE TO THE CONSUMING MARKETS—SOME RECORD COFFEE CARGOES SHIPPED TO THE UNITED STATES—TRANSPORT OVER SEAS—HANDLING COFFEE AT NEW YORK, NEW ORLEANS, AND SAN FRANCISCO—THE COFFEE EXCHANGES OF THE UNITED STATES, EUROPE, AND BRAZIL—COMMISSION MEN AND BROKERS—TRADE AND EXCHANGE CONTRACTS FOR DELIVERY—IMPORTANT RULINGS AFFECTING COFFEE TRADING—  
SOME WELL-KNOWN GREEN COFFEE MARKS.

**I**N moving green coffee from the plantations to the consuming countries, the shipments pass through much the same trade channels as other foreign-grown food products. In general, coffee goes from planter to trader in the market center; thence to the exporter, who sells it to an importer in the consuming country; he in turn passing it on to a roaster, to be prepared for consumption. The system varies in some respects in the different countries, according to the development of economic and transportation methods; but, broadly considered, this is the general method.

The marketing of coffee begins when it is bagged and sent from the plantations to the market centers. Motor trucks usually carry it to the nearest railroad or river.

#### *Buying Coffee in Brazil*

Brazil, as the world's largest producer of coffee, has the most highly developed buying system. Coffee cultivation has been the chief agricultural pursuit in that country for many years; and large amounts of government and private capital have been invested in growing, transportation, storage, and ship-loading facilities, particularly in the State of São Paulo.

The usual method in Brazil is for the *fazendeiro* (coffee-grower) to load his shipments of coffee at an interior railroad station. If his consignee is in Santos, he deposits the bill of lading with a bank and draws a draft, usually payable after thirty days, against the consignee. When the consignee accepts the draft, he receives the

bill of lading, and is then permitted to put the coffee in a warehouse.

Since 1930 the usual method of marketing in the State of São Paulo has been changed by a scheme of regulated rail shipments from interior stations or warehouses to the port of Santos, which requires inscription of crops and retention of same in interior warehouses, subject to apportionment of shipping quotas in series and dispatch groups.

The daily entries at Santos are limited to an amount corresponding to the maximum of double the average monthly exportation, calculated on the basis of the preceding year. The plan aims at price stabilization by preventing accumulations of un-marketed surpluses at the seaboard. It was first administered under the authority of the São Paulo Coffee Institute, then by the National Coffee Council and, since 1933, by the National Coffee Department (DNC). Included under this scheme was the acquisition and destruction by burning of some 35 million bags of coffee representing the Brazilian crop surpluses existing up to the end of the 1933-34 crop.

#### *Brazil's Coffee Ports*

The coffee trade of Rio de Janeiro and Santos is the most important in the world. Formerly Rio was the more important of the two, but with the development of the huge coffee industry in the State of São Paulo, Santos became the leader.

As the capital of the nation Rio is a metropolitan city of statecraft, diplomacy,



**AEROPLANE VIEW OF THE ENTRY TO THE PORT**

Showing the carefully-tended navigable channel and, in the distance, the Atlantic Ocean. The building at the angle is the administrative office of the Dock Company. The illustration shows the first warehouses to meet the eye of the incoming traveler, and these buildings continue for miles up the great harbor.



**BIRD'S-EYE VIEW OF THE NEW COFFEE WAREHOUSES**

This great block of modern concrete structures extends nearly 700 feet back from the dock side. In the background are the foothills of the great São Paulo plateau. In about seven miles there is an abrupt rise of over 2,000 feet.

**SOME RECENT AERIAL VIEWS OF THE CITY AND HARBOR OF SANTOS**

Photos by Capt. S. H. Holland, of the British Army.



THE CAES DO PORTO AT RIO DE JANEIRO, SHOWING SOME OF THE ELECTRIC CRANES

wealth, and fashion first, while Santos, on the other hand, is a coffee city first, last, and all the time. In Rio it is possible to move about for days and never be reminded of coffee; in Santos at no hour of the day or night is it possible to escape from the coffee atmosphere. In the daytime some form of coffee activity is always in the picture; at night coffee is so much a part of the social life of the city that no social function is free from some suggestion of coffee's supremacy.

Brazil's other coffee ports in the order of their importance are: Victoria, Parana-gua, Bahia, Recife (Pernambuco), and Angra dos Reis.

A new coffee port is being established at São Sebastião, between Santos and Angra dos Reis. It will receive supplies from eastern São Paulo and Minas, being of easy access to the Rio-São Paulo rail connections and not far from some important coffee estates. The new port is the result of an agreement between the Federal Government and the State of São Paulo, the latter to exercise authority for sixty years, at the expiration of which the Federal Government will assume control.

#### *Coffee Buying in Rio*

There are about forty firms and individuals engaged in the coffee business in the city of Rio de Janeiro. They are located for the most part on Rua São Bento, Rua São Pedro, Rua da Quitanda, Rua Vis-

conde Inhauma, and the Avenida Rio Branco.

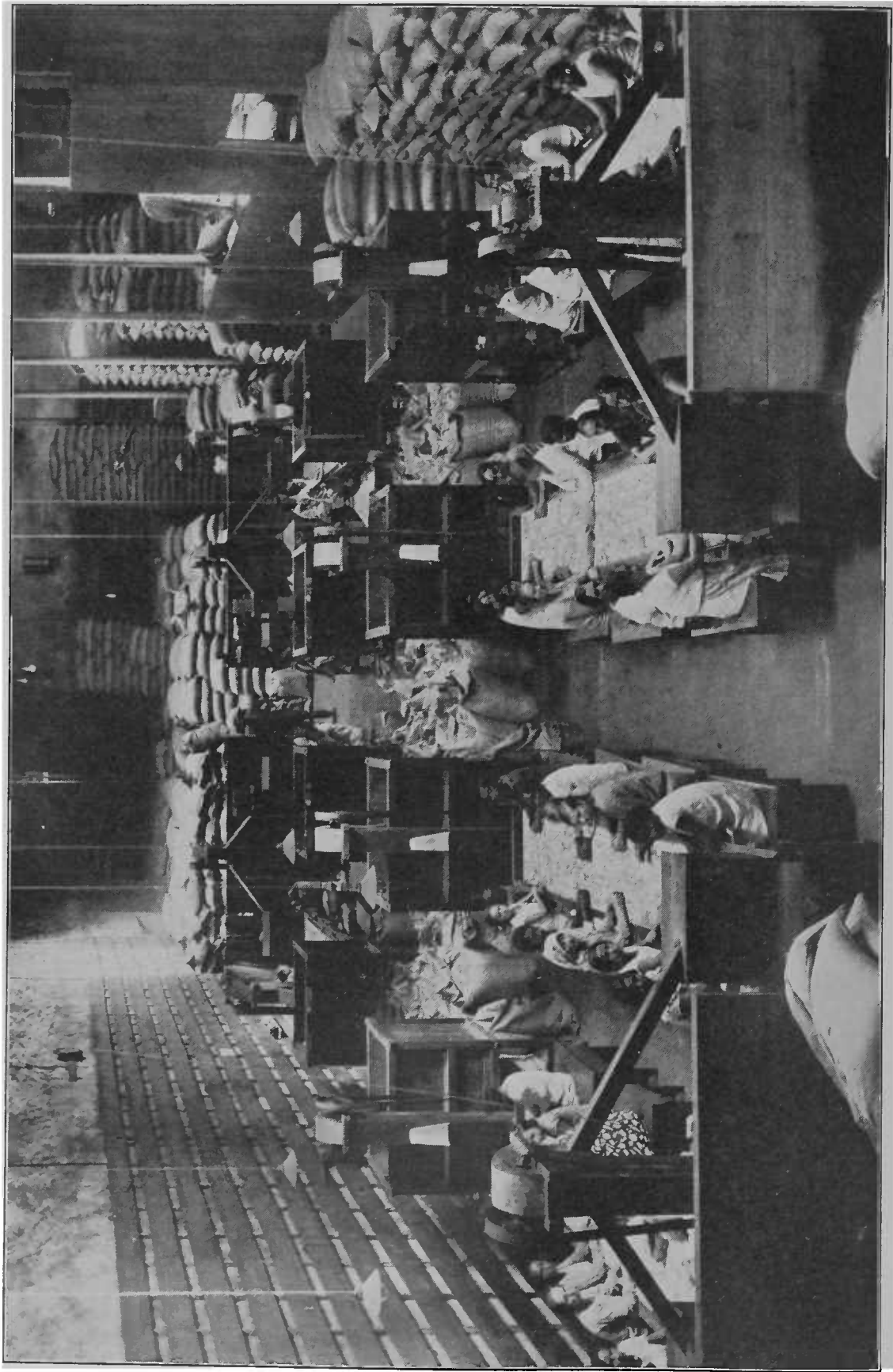
The Coffee Exchange, known as the Centro de Comercio do Café, was founded April 19, 1920, and is located on the Rua da Quitanda. Here, in little glass cubicles, representatives of the coffee fazendas display their samples daily except Sundays and holidays, between the hours of 9 and 10 a.m. There is also a ring where the brokers trade in futures.

#### *Coffee Buying in Santos*

Coffee built Santos, and keeps it growing at a marvelous rate. Fifty miles inland on the plateau lies the city of São Paulo in the heart of the world's greatest coffee producing area, and from it more than a billion pounds of the green berries annually pour down grade into Santos for shipment overseas. As a result of the economic situation, Santos is the greatest coffee port in the world. In addition, nature has made it one of the best ports on the Atlantic ocean. All steamers go alongside of quays, and whereas formerly coffee had to be transported to the warehouses and then be carried by stevedores aboard lighters for loading on vessels in mid-stream, now the railway runs right onto the docks and mechanical conveyors do the loading from the dock warehouses.

There are some three miles of modern concrete docks with a score of immense dock warehouses for coffee, and further





GRADING COFFEE FOR EXPORT; TYPICAL SCENE IN A SANTOS WAREHOUSE

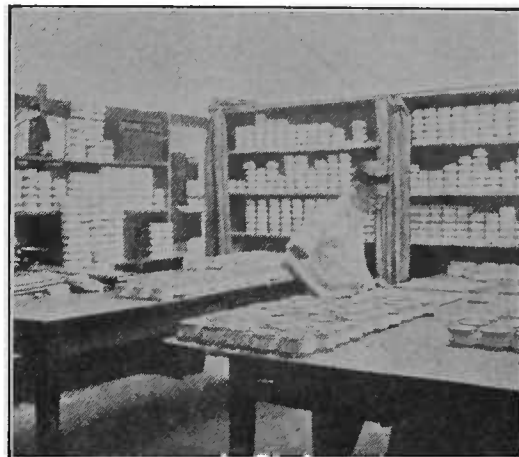
back from the waterfront are as many more. Their aggregate storage capacity is more than five million bags of coffee.

#### Storing at Santos

At Santos most of the storing is done in the new steel and brick warehouses of the Santos Dock Company, a private corporation whose warehouses extend for three miles along the waterfront at one end of the town. Railroad switches lead to these warehouses, so that the coffee is brought to them in some cases in the same cars in which it was originally loaded up-country. In cases where the coffee comes from the interior over a narrow gauge railroad, the transfer into railroad cars of broad gauge is made either in São Paulo, Campinas, or Jundiahy. Many of the *commissarios* and exporters have their private warehouses in the City of Santos and the coffee is transferred from the railroad station to these warehouses by automobile trucks or mule carts.

Coffee is shipped from the interior to Santos in a special type bag, which is lighter in weight than the official export bag. It is usual for these bags to be sent to the interior one or more times, as all of the coffee after arrival in Santos is re-bagged into new official bags. When the coffee arrives in Santos it is sampled at the door of the warehouse by a checker who draws two or three handfuls with a coffee-trier, resembling a cheese-tester, and the coffee is then put into different piles in accordance with the grade and color of the contents of the bag. These samples are sent to the *commissario* or exporter to whom the consignment is made, and another set of the samples is retained by the warehouse for later comparison. The consignee, after examination of grade, color, roast, and cup, makes up the *ensaque*, or bagging, of the lot. Having assembled the various coffees, order is given to the warehouses to mix the coffee and put it into new official export bags. Two samples of the finished lot are sent to the *commissario* or exporter for whom the coffee was bagged, and one sample is again retained at the warehouse for future reference.

Samples of the lots are put on the Street, if they belong to a *commissario* or public warehouse company who are offering the coffee for sale for the consignor, and these are taken around by a spot bro-



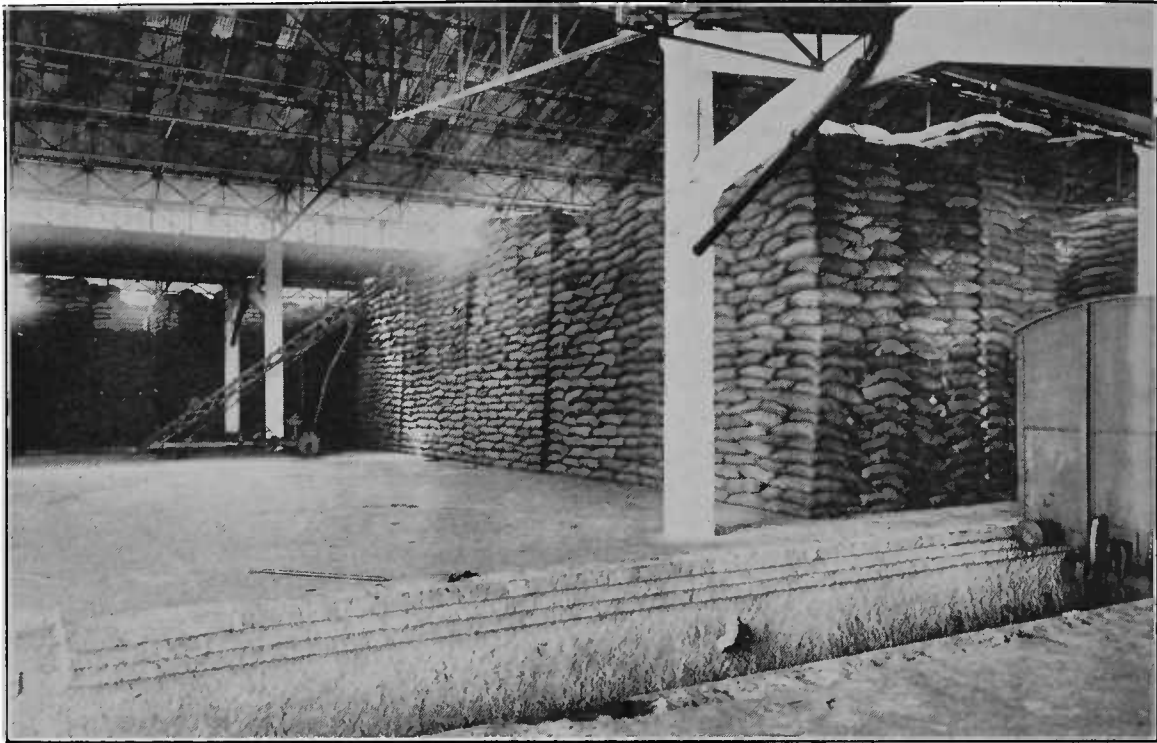
GRADING ROOM IN A SANTOS EXPORTER'S OFFICE

ker to the various exporters for their examination. The system varies from a rapid sight-grading, which is generally done in the afternoon, to a more careful examination done in the morning hours. Most houses grade, roast, and cup each chop and make notations of same in accordance with their own private type or in accordance with standards of the New York Coffee and Sugar Exchange.

When the coffee is bagged the warehouse puts an identifying number on each chop which is stamped on the end of the bag, and when the coffee is shipped overseas the exporter supplements this with a further identifying mark; generally with the initials of the buyer or with the name of his house brand.

Coffee is sold in Santos "cash as removed, full settlement in thirty days, less discount at the rate of six per cent per annum" for the unexpired term. It is interesting to note that if an order is drawn on the seller for a lot of coffee before eleven in the morning, payment for same is made in the afternoon of the same day. If the order is drawn after eleven, the payment may be deferred until the following day.

The procedure regarding shipment may vary in accordance with Governmental regulations ruling at the time—for instance, when a sale is made "Cost and Freight" the report of same is registered with the National Coffee Department and with the Exchange Fiscalization Board of the Banco do Brasil. The exporter effects the exchange on the transaction through an official exchange broker, who in turn sends in a signed contract with the purchasing bank. In order to commence the shipment,



**MECHANICAL PILING DEVICES IN A COFFEE INSTITUTE WAREHOUSE**

These mechanical conveyors speed up the operation of stacking the 132-pound bags of coffee in properly classified piles that reach the full height of the clear space beneath the roof trusses.



**THESE COFFEE TRUCKS AND TRAILERS ARE TYPICAL OF SANTOS**

Many exporters have private warehouses and the coffee is transported from the railroad station to these warehouses by automobile trucks and trailers.

**MODERN COFFEE HANDLING AND TRANSPORT METHODS**



BAGGING AND PILING COFFEE IN A SANTOS WAREHOUSE

the coffee has to be dispatched; that is to say, the export taxes are paid to the National Coffee Department through the Banco do Brasil and a further statistical record is sent through the State Revenue Department. There are no state export taxes at the present time. For statistical purposes a copy of the dispatch has to be sent to the dock company with calculation of the *capatazias*, or dock charges, although these charges are now waived by the dock company. After completion of these formalities the coffee is ready to be loaded on board, and is conveyed from the warehouses in motor trucks or mule carts direct to the quay. On leaving the warehouse the coffee is stenciled with the shipping mark. Some bags are stenciled twice as a signal that such bags have had samples drawn therefrom and are under 132 pounds net weight per bag. Test weights are made to determine that the full weight is in the bags. Likewise the weights are tested at shipside. As each cart or truck drives away from the warehouse the driver is given a card on which is printed the number of bags and on which is rubber-stamped the name of the steamer. On arrival at the receiving gate for the steamer this card is taken up by the ship's checker who verifies the quan-

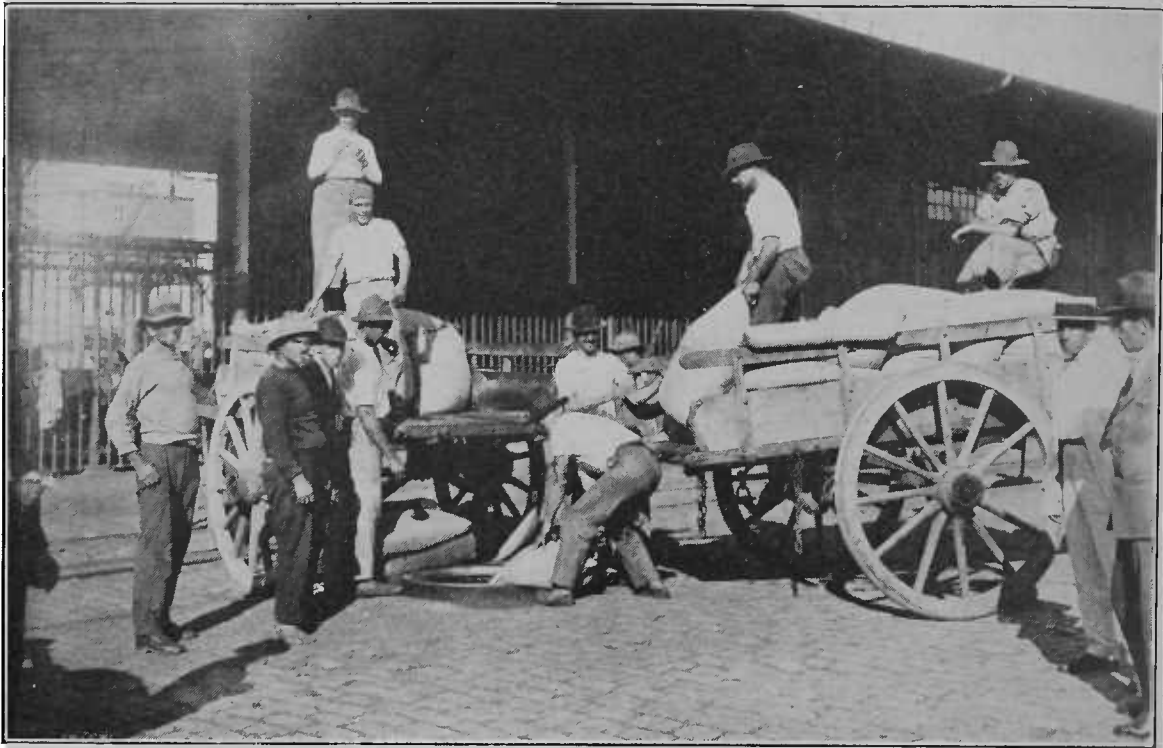
tity and returns one of the stubs to the driver. These stubs are in turn surrendered to the steamship company in exchange for a bill of lading. On receipt of the bill of lading the exporter then draws his draft in accordance with the terms of the sale and discounts the draft at the bank with which he has contracted the exchange. Generally, the drafts are drawn at 90 days sight on New York or London; however, of late years considerable business has been done at sight or ten-days sight, either on New York, London, or other important financial center.

To some countries it is necessary to obtain a consular invoice or a certificate of origin. These are obtained at the consulate of the country of destination and are, in most cases, attached to the drafts handed in to the bank. Drafts are stamped with the Brazilian Federal Revenue stamps in the value of three milreis to each one thousand milreis value of the draft.

#### *Loading at Santos*

The docks have accommodations for about fifty ocean steamers at one time, and the electrically-driven dock machinery, which is unequalled in any other part of





**STREET CULVERT FOR RECEIVING COFFEE FROM THE ARMAZENS OR STORAGE WAREHOUSES**

These receivers for the automatic conveyors in the streets along the docks, outside the iron gratings which guard the miles of wharves and warehouses, lead to a system of endless rubber belts.



**DELIVERY OUTLET OF THE ENDLESS RUBBER CONVEYOR OVER THE SHIP'S HOLD**

From the street manhole one belt leads to another, running at right angles, and so on up and over the pier, thus delivering the bags on deck with clock-like regularity. A few men handle all the work in contrast with the swarms of stevedores formerly required.

**THE MECHANICAL COFFEE CONVEYOR IN ACTION AT SANTOS**



the world, loads the coffee with amazing speed. A typical loading scene discloses five belt conveyors, three electric cranes, and five lines of laborers pouring continuous streams of bagged coffee into a single steamer's hold.

From its storage place in one of the great warehouses, where it is neatly piled, the coffee is transported by long trains of motor trucks or mule carts to the dock yards.

There the bags are dropped from the trucks and carts through manholes leading to a partly underground system of endless conveyor belts, which carry it until it is dropped by the sides of the open steamship hatches. Several thousand bags an hour are thus loaded aboard steamer with a minimum of labor, care being taken not to drop the bags more than two or three feet, in their fall to the deck.

#### *Stowing Coffee Aboard Ship*

Experienced stevedores are employed in every hold to see that the bags are properly stowed. This is one of the important features of shipment, as the condition of the coffee at destination depends much upon the initial efforts of the loading. The bags are stowed in tiers supported by wooden battens six inches wide and one inch thick. At every three tiers the bags are covered with burlap or matting, and great care is taken that no metal touches the bags in transit. To insure this, all stanchions, ventilators, or other metal objects are covered with burlap, so no "sweat" from them can touch the bags of coffee.

Abundant circulation of air is imperative throughout the voyage, to preserve the dryness of the cargo, and while modern steamships are equipped with cargo ventilating systems, still the masters of the ships always have the hatch covers removed in good weather.

Coffee cargoes are reasonably sure to be in perfect condition up to three days before the arrival of the vessels in New York, but during the remainder of the run to port conditions arise which require special attention. On the voyage up from Brazil the steamships come through waters that have a temperature averaging 80° F. Suddenly the ship emerges from the warmth of the Gulf Stream into water having temperatures as low as 40°. The sudden drop causes heavy condensation between decks,

and the sweating that is so undesirable begins with intensity. This sweating, however, does not damage the coffee, merely causing some of the bags to become damp, and these have to be sorted; a necessity which adds to the carrier's cost of handling the cargo.

#### *Santos Coffee Exchange*

The Bolsa Official do Café of Santos is an impressive temple in stone. Its interior suggests some Old World church; only its stained glass, its paintings, its main architectural features, its columns, inlaid marble floors, furniture, and fixtures are distinctly modern.

The large trading room is surmounted by a magnificent dome, and behind the platform are three enormous paintings of stirring scenes in Brazil history. There are banquet halls, a restaurant, and offices for brokers.

The president and other officers sit on a dais at one end. Around the big hall in two semicircles of high-backed chairs are seated the members, each with his own small round-topped table before him.

The Bolsa, however, is merely the "Bourse" where the contracts are bought and sold. The contracts are registered with a clearing house, Caixa da Liquidação, which is a private corporation.

The Caixa is a stock corporation and the government of São Paulo is liable for 40 per cent of its liquidating commitments. Every broker operating on the Bolsa must be licensed, and either he or his official representative must be present at all sessions. No broker can undertake business without depositing a bond in money or bonds of the State of São Paulo amounting to 20 contos of reis.

The association passes on practically all matters relating to coffee transactions, gives official gradings on all coffee brought before it, and provides for all necessary arbitrations covering differences that may arise between buyers and sellers. One of the unique regulations provides that when coffees are tendered for redelivery this can be done on the delivery of the original samples tendered with the seals as originally received, unbroken; if otherwise, they are subject to regrading, with a further charge.

A tax is collected by the Exchange on all transactions, which provides revenue



GENERAL VIEW OF THE COFFEE-TRADING RING IN THE SANTOS BOLSA OFFICIAL DO CAFÉ

Note the stained-glass ceiling, the inlaid marble floor, and the coffee brokers' trading "pews," each with individual "prayer desk" or table.

for its upkeep and has also been used for the new Exchange Building.

Margin requirements are large compared with the New York Exchange, and with the numerous safeguards thrown around contracts they are looked upon as being extremely safe. The Caixa provides for the liquidation of contracts by a maximum capital of 3,000,000 reis, in which the Government may be interested to the extent of 40 per cent, as previously stated.

Brokers on the Exchange are limited to those of Brazilian citizenship, must be 21 years old and enjoy full civil rights. Before being accepted they must have a certificate indorsing them given by at least three reputable commission or expert dealers in the Santos market. No one can be a licensed broker who has failed and has not received a clear discharge in bankruptcy or whose business record cannot stand the closest scrutiny. No broker, when acting as such, can be a partner of any mercantile firm nor deal for his own account in either spot or future coffees.

Unlike the New York Coffee Exchange,

transactions in the street are not prohibited—as a matter of fact, the bulk of the business is done in the street—but the exchange must be notified of all such transactions. Any broker who does not appear at the daily calls of the Exchange, either in person or through one of his assistants, is liable to fine, and this also applies for failure to report any transaction to the Exchange made outside.

The entire work of the Exchange during the past few years has been such that the stock commands a substantial premium. The market has been sufficiently trying to test the machinery of the Santos Coffee Exchange to the utmost, and its record during these difficult years is one of which it may well be proud.

There are some 60 concerns and individuals engaged in the coffee business in Santos. They are located on the streets adjacent to the Bolsa, particularly Rua 15 de Novembro, Rua do Commercio, Rua Santo Antonio, and Rua Frei Gaspar.

A great change in the merchandising of coffee at Santos in recent years is the dis-

appearance of the *commissario* business which once formed the backbone of the market. Exporters and commission houses are now buying direct from planters in the interior, and regular markets have sprung up in all important coffee centers like Lins, Rio Preto, Bauru, Araraguara, Ribeirão Preto, etc. As in the case of many other commodities, around the world, the tendency of the coffee trade in Brazil is toward the elimination of middlemen.

#### *The World's Greatest Coffee Railway*

From Santos to São Paulo the 49-mile trip is made over one of the costliest railroads of South America and one that pays perhaps the highest dividends to its stockholders. The São Paulo Railway on its way from Santos climbs the granite wall of the Serra on one of the steepest grades known in railway construction, rising 2,500 feet within six miles. The road is the last word in railway construction. Being a great money earner, no money is spared to keep the roadbed in perfect condition. A remarkable series of cemented channels protect the road from landslides and freshets. Every possible assault by nature is guarded against. Even rocks, beside the double tracks, are tarred to preserve them from the elements. The hillsides have been reinforced, water courses constructed, and model stations, power houses, and employees' cottages built along the way. The line frequently disappears into tunnels blasted out of solid granite. Again, it runs over steel bridges swung across dizzy heights and, needless to say, there is a perfect system of block signals.

#### *Valorization*

Stiff advances in the prices paid for coffee during the 'nineties brought about an ultimate over-production, and, in the following decade, a serious crisis developed. It was the late Count Alexandre Siciliano, assisted by others, prominent among whom was the late Dr. Albuquerque Lins, who succeeded in bringing about the convention of Taubate at which the states of São Paulo, Rio de Janeiro, and Minas concluded an alliance for the defense of Brazilian coffee interests. It resulted in the great coffee operation of 1906-07 called the first valorization, and was necessitated by that year's bumper yield of almost 20,-

000,000 bags at Rio and Santos. It brought the State of São Paulo almost to the verge of bankruptcy, but became highly successful, later, through a number of crop failures and the genius of the late Hermann Sielcken, the New York coffee king, who enlisted the aid of others and financed the valorization scheme. Sielcken arranged a loan of \$75,000,000 from banking houses in England, Germany, France, Belgium, and the United States. The government of São Paulo purchased 8,000,000 bags of coffee and stored them for a more favorable market.

In 1910, Santos 4s reached 13¾ cents on the New York Exchange, the highest price in 23 years. Another valorization took place in 1914 on account of war conditions. Both this and the first valorization were carried out by the Paulistas, and both finally showed good results when the belligerent nations of Europe absorbed the balance of coffee held in store, after the war broke out. The high prices received for coffee in 1915-16 definitely restored prosperity in São Paulo, but in 1917 the State was again forced to resort to valorization, purchasing 3,000,000 bags and constructing enormous warehouses for their storage on the docks at Santos. Valorization was once more employed in 1921, liquidation being effected in 1924.

#### *Marketing Organizations*

The Associação Commercial de Santos, the supreme organ and spokesman of coffee merchants and exporters of Santos, was formed in 1870 with 106 charter members. It maintains a Court of Arbitration, draws up rules defining trade customs, and has rendered valuable service in many matters of public interest.

The Coffee Institute of the State of São Paulo was created by a law passed in December, 1924. The formation of the Institute represented a change in policy from valorization to regularized flow of coffee into the market in accordance with consumption requirements. Under valorization it was found that incomes from coffee planting could not be stabilized, and that the plan was not calculated to secure a fair income for the planter.

Regulated flow of shipments appeared to be the way out of the difficulty, and it was felt that only the Government could give effect to such operation, because of the gen-

erally recognized fact that farmers will seldom adapt themselves to any form of organized business. The Government of the State of São Paulo undertook the formation of the Coffee Institute of the State of São Paulo, which started its operations in 1925. The plan adopted consisted in establishing maximum stocks at several ports of exportation, and regulating the entry of coffee into these ports during any given month on the basis of the exportation of the previous month. This basis has been changed (by the DNC in 1934) to a maximum of double the average monthly exportation of the previous year.

A National Coffee Council, representing the coffee states, was created in 1931 to carry out the provision of a Government decree for an export tax of ten shillings on coffee for the purpose of purchasing and burning surplus stocks. The Council was abolished in 1933 when the Government assumed control over all institutes and associations engaged in coffee by the organization of the Departamento Nacional do Café, as a part of the Ministry of Finance.

The Departamento Nacional do Café is concerned with coffee throughout the extent of Brazil as regards its culture, processing, warehousing, financing, sale, and shipment; the purpose of its creation being that of absolute control of the commodity to improve quality, assure supplies adapted to demand, assist the planters, and limit exports in volume so as to prevent oversupply abroad and thus avoid price depreciation. Throughout its life of less than two years, its policy has been consistent and its frank dealings with its own constituents as well as with foreign consumers has won a confidence that has undoubtedly eased its task.

Among the difficulties encountered was the fact that the National Coffee Council, whose place was taken by the DNC, had as

### TABLE OF EQUIVALENCE OF COFFEE DEFECTS IN BRAZIL

Effective March 1, 1935, per Federal Decree No. 24,541  
of July 3, 1934.

1 black bean = 1 defect	1 large husk = 2 defects
1 large twig = 10 defects	1 small husk = 1 defect
1 med. twig = 5 "	2 sour beans = 1 "
1 small twig = 3 "	2 sailors = 1 "
1 large stone = 10 "	5 shells = 1 "
1 med. stone = 5 "	5 quakers = 1 "
1 small stone = 3 "	5 undeveloped beans = 1 "
1 large clod of earth = 10 "	5 green beans = 1 "
1 med. clod of earth = 5 "	10 broken beans = 1 "
1 small clod of earth = 3 "	1 pod = 1 "

part of its policy the purchase of available coffee, based on samples, at a fixed price. Following the establishment of the DNC, samples continued to be received and it was decided to make corresponding purchases, this as safeguard against complaints which were "many and constant." Accordingly, by March 20, 1933, all coffee covered by bills of lading retained in regulating warehouses was purchased and paid for, an aggregate of 11,556,674 bags.

This purchase, so readily carried through, greatly relieved the domestic situation. However, the estimate for a big 1933-34 crop became a threatening factor. The 40 per cent "sacrifice quota" decided on to absorb the surplus, became the solution. Up to May 31, 1934, some 10,976,804 bags were received on this quota and by June 30 payment had been made for 9,082,252 bags, others to take their turn on verification of data. Payment of freights, warehousing, and other charges accounted for heavy expenses. In addition new warehouses and sidings had to be built.

The taxes and costs against Brazil coffee from the time it leaves the plantation until it reaches the port of New York are summarized in the accompanying table.

### BRAZIL COFFEE-HANDLING CHARGES

	—Minas Geraes—				
	São Paulo	Rio	Santos Ang. dos Reis	Rio	Esp. Santo
15 Shilling tax .....	44\$784	44\$784	44\$784	44\$784	44\$784
Other taxes .....	12\$600	9\$050	12\$472	9\$400	11\$600
Total taxes per bag (132 lbs.).....	57\$384	53\$834	57\$256	54\$184	56\$384
Total taxes at a rate of 11\$640 (per bag of 132 lbs.).....	\$4.93	\$4.63	\$4.91	\$4.66	\$4.84
Total Brazilian taxes per am. lb. ....	3.74¢	3.51¢	3.72¢	3.53¢	3.67¢
Expenses from Fazenda to board ship (per am. lb.).....	1.15¢	1.15¢	1.15¢	1.15¢	1.15¢
Freight, insurance, etc., Brazil to New York (per am. lb.).....	.55¢	.55¢	.55¢	.55¢	.55¢
Total expenses from Fazenda to New York (per Am. lb.) Nortz & Co.	5.44¢	5.21¢	5.42¢	5.23¢	5.37¢

The following code descriptions, now in use between Santos and overseas markets, employs fifty-eight numbers to indicate the various types and characteristics of coffee bought and sold in that market:

*Code Numbers*

- 01—Flat bean, good roast, hard, free from Rio flavor.
- 02—Part Bourbon, part flat bean, good roast, soft.
- 03—Part Bourbon, part flat bean, good roast, strictly soft.
- 04—Bourbon, good roast, hard, free from Rio flavor.
- 05—Bourbon, good roast, soft.
- 06—Bourbon, good roast, strictly soft.
- 07—Bourbon, good bean, good roast, cup tested, strictly soft, very desirable quality.
- 08—Bourbon, good bean, good roast, strictly soft.
- 09—Bourbon, good bean, good to fine roast, soft.
- 10—Bourbon, good bean, good to fine roast, cup tested, acidity, strictly soft, very desirable quality.
- 11—Genuine Bourbon, good roast, soft.
- 12—Genuine Bourbon, good roast, strictly soft.
- 13—Genuine Bourbon, good bean, good roast, cup tested, acidity, strictly soft, very desirable quality.
- 14—Genuine Bourbon, good bean, good roast, strictly soft.
- 15—Genuine Bourbon, good to fair roast, strictly soft.
- 16—Genuine Bourbon, good bean, good to fair roast, strictly soft.
- 17—Genuine Bourbon, curly bean, good roast, strictly soft.
- 18—Genuine Bourbon, curly bean, good to fair roast, strictly soft.
- 19—Good bean.
- 20—Good roast.
- 21—Good bean, good roast.
- 22—Good bean, good to fair roast.
- 23—Good bean, good roast, soft.
- 24—Good bean, good roast, strictly soft.
- 25—Good roast, soft.
- 26—Medium bean.
- 27—Medium bean, good roast, soft.
- 28—Medium bean, good roast, strictly soft.
- 29—Bold bean, good roast, soft.
- 30—Bold bean, good roast, strictly soft.
- 31—Large bean, good roast, soft.
- 32—Large bean, good roast, strictly soft.
- 33—Good to large bean, good roast, soft.
- 34—Good to large bean, good roast, strictly soft.
- 35—Good to large bean, good to fair roast, soft.
- 36—Good to large bean, good to fair roast, strictly soft.
- 37—Good to large bean, fine roast, soft.
- 38—Good to large bean, fine roast, strictly soft.
- 39—Peaberries, good bean, good roast, strictly soft, practically free from flats.
- 40—Peaberries, good bean, good roast, strictly soft, practically free from pods.
- 41—Peaberries, good bean, good roast, strictly soft, practically free from flats and pods.
- 42—Peaberries, good to fair roast, strictly soft, practically free from flats and pods.
- 43—Separations, fair roast, soft.
- 44—Separations, fair to good roast, soft.
- 45—Separations, good roast, soft.
- 46—Separations, good roast, good cup quality, strictly soft.

- 47—Separations, good roast, fine cup quality.
- 48—Separations, soft.
- 49—Grinders, strictly soft.
- 50—Grinders, good roast, strictly soft.
- 51—Grinders, good roast, good cup quality, strictly soft.
- 52—Grinders, good roast, fine cup quality, strictly soft.
- 53—Santos peaberries, good bean, good roast, soft.
- 54—Santos peaberries, good bean, good roast, strictly soft.
- 55—Santos peaberries, medium bean, good roast, strictly soft.
- 56—Santos peaberries, good to bold bean, good roast, strictly soft.
- 57—Bourbon good to bold bean, good to fine roast, cup tested, strictly soft, very desirable quality.
- 58—Bourbon good bean, good roast, strictly soft, cup tested, desirable quality.

Abbreviations commonly used in the Santos market are: G.R., good roast; S., soft; S.S., strictly soft; Pby., Peaberry; G. to F.R., good to fair roast; and F.B., flat bean. These descriptions apply to "terrace" or hull-dried coffee. For pulped or "washed" the color description is added.

BRAZIL TABLE OF DEFECTS

in tins of 300 grams, or 2/3 of a pound

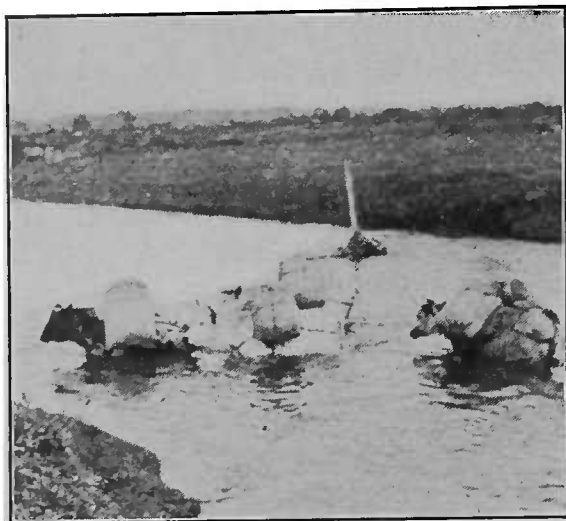
Type	Defects	Type	Defects
2	4	5/6	66
2/3	8	6	86
3	12	6/7	123
3/4	19	7	160
4	26	7/8	260
4/5	36	8	360
5	46		

*Shipping Coffee from Colombia*

As Colombia ranks next to Brazil in coffee production a brief description of its unique transportation will be of interest to coffee receivers. Coffee is grown in practically all the mountainous regions of the interior and, broadly speaking, it is transported to the seaports in two ways: either by the Magdalena River to the North Coast ports of Puerto Colombia and Cartagena on the Caribbean Sea or via several railway systems in the West to the port of Buenaventura on the Pacific side.

The coffees destined for movement down the Magdalena River come from the districts of Girardot, Honda, Tolima, Libano, Manizales, Medellin, Bucaramanga, Ocaña, Cúcuta, etc., and in practically every instance they are transported by rail to one of the Magdalena River ports, such as Girardot, Honda, La Dorada, Puerto Berrio, and Puerto Wilches. At the river ports they are loaded on boats and if their des-





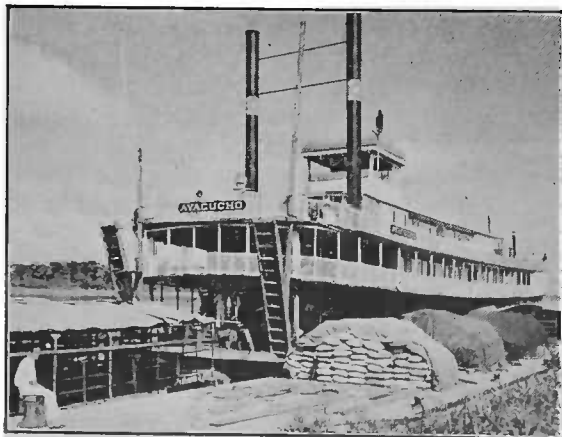
COFFEE-LADEN OXEN FORDING STREAM, COLOMBIA

tinuation is Barranquilla, they are either discharged at that city, or else are transferred to a rail line skirting the coast and landed at the ocean port of Puerto Colombia, seventeen miles away.

In 1935, the mouth of the Magdalena River, which for many years had been closed by a bar of sand and silt, was opened, and a deep water channel now permits ocean steamships to receive and discharge cargoes directly at Barranquilla.

River cargoes destined for Cartagena, on the North Coast, are either transported through the Dique Canal from Calamar on the Magdalena to the port, or are transferred to railway cars at Calamar for the sixty-five-mile trip to Cartagena.

The port of Buenaventura on the West Coast receives coffee by rail from the ever-enlarging districts of the Western Cor-



STEAMBOAT LOADING COFFEE AT A MAGDALENA RIVER PORT

dilleras. The principal growths shipped through that port bear the district names of Armenia, Manizales, Caldas, Sevilla, Cumbre, Cali, and Cauca.

Through Santa Marta, a banana port on the Caribbean, where the mountains lean down to the sea, a fancy coffee, known as "Santa Marta Plantations," is shipped. This coffee is grown at high altitudes, and on several plantations where the going is too rough even for mules, the berries are piped down by gravity to cleaning stations below.

Besides carriage by rail and river, Colombia has unique aerial systems of transportation. One of these, the Mariquita cable-way is some 45 miles in length, and traverses unbelievably rough terrain from

*Grace Line.*

RIVER BOATS UNLOADING COFFEE AT BARRANQUILLA

Manizales, in the Department of Caldas, to the town of Mariquita on a railway which transports them to the Magdalena River port of La Dorada, for shipment to Caribbean ports.

#### *Transit Routes to Sea Ports*

On account of its isolated geographical position Cúcuta, the capital of the Department of North Santander, has been forced to depend largely on the port of Maracaibo, Venezuela, for an export outlet for its coffees, although Barranquilla and Cartagena receive part of the Cúcuta coffees which are transported on mule-back and by motor trucks over the mountains to the Bucaramanga railway, and thence via Puerto Wilches and the Magdalena River to the northern ports in Colombia.

A shipment of coffee leaving Cúcuta for



Copyright by Scadta

AIRPLANE VIEW OF PUERTO COLOMBIA AND ITS 4,000-FOOT RAIL AND STEAMSHIP PIER

Maracaibo goes through the following steps on its way to a foreign market:

1. From Cúcuta, it travels thirty-five miles by railroad to Puerto Villamizar, a Colombian river port on the Zulia River.

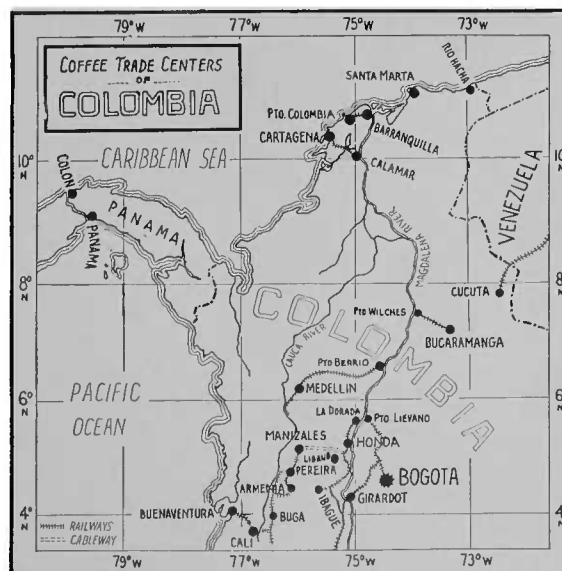
2. At Puerto Villamizar it is loaded into small, flat-bottomed, steel lighters that are taken to Puerto Encontrados by man power. Puerto Encontrados, belonging to Venezuela, is on the Catatumbo River; and the trip from Villamizar takes from two to four days, depending on the depth of water in the river. During high water, river steamers are also used, and make the trip in less than a day.

3. At Encontrados the cargo is loaded on river steamboats more or less of the Mississippi River type, which take it to Maracaibo, Venezuela. Coffee is also carried to Maracaibo by small sailing vessels.

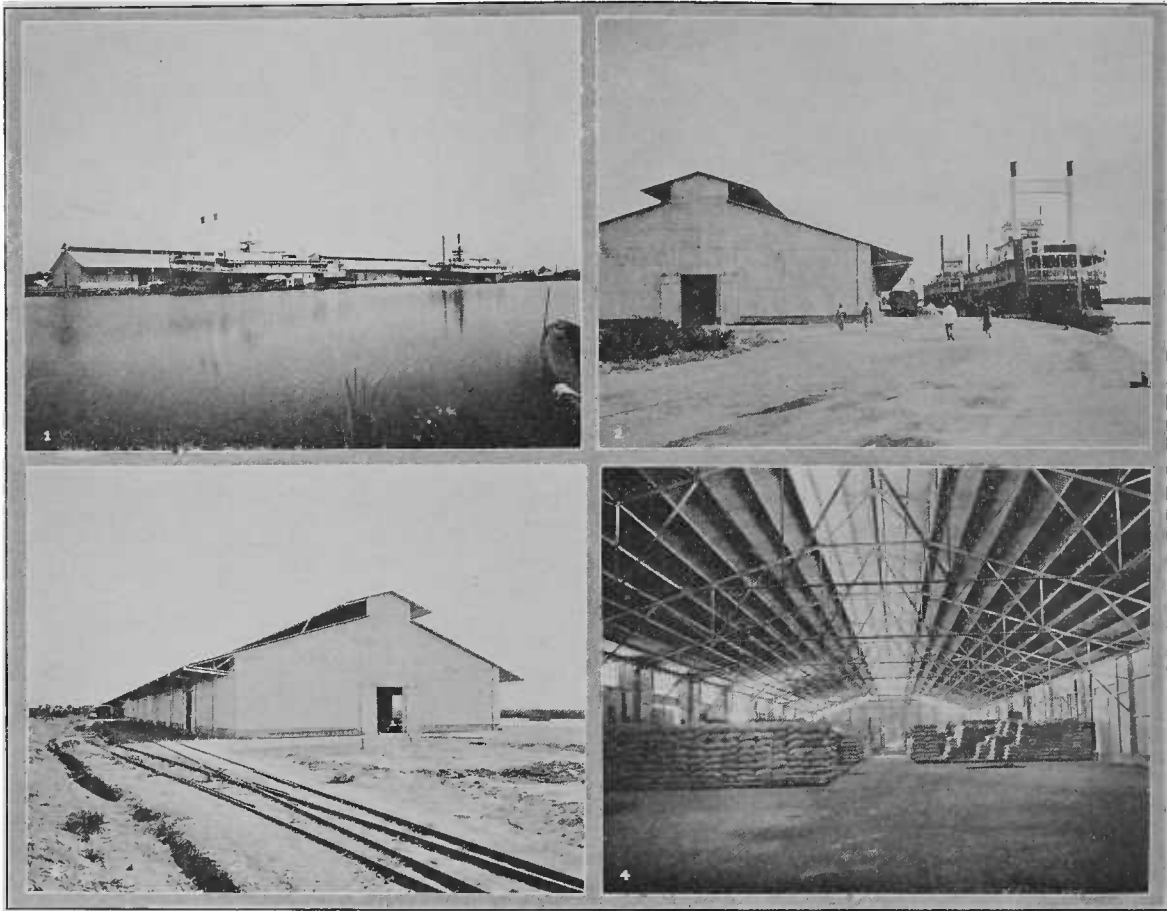
4. At Maracaibo it is taken by ocean vessel, which either carries it direct to New York or to Curaçao, Netherlands West Indies, where it is transhipped to steamers plying between New York and Curaçao. It is obvious that the many transhipments that coffee coming from Cúcuta has to undergo greatly retards its arrival at a foreign port; and this has served as an incentive for developing the all-Colombian route via the

Magdalena River to Barranquilla and Cartagena.

Coffee from Cúcuta is stored in the Venezuelan custom-house, from which it must be shipped for export within forty-five days, or the shipper runs the risk of having it declared by the Venezuelan Government for *consumo* (home consumption)



TRANSPORTATION ROUTES IN COLOMBIA



SCENES AT THE NEW COFFEE WAREHOUSE AND DOCKS, BARRANQUILLA, COLOMBIA

(1) Magdalena River steamboats at the docks. (2) East end of one of the warehouses. (3) West view of the warehouses. (4) Interior of warehouse.

at a prohibitory tariff. Arrangements can be made at considerable cost to have the coffee taken to a private warehouse; but it is no longer possible to make up the chops in Maracaibo, as was done formerly with all the Cúcutas. The Venezuelan customs will not even allow the Maracaibo forwarding agent the same chops, as a general rule. Special permission must be obtained to change any bags that are stained or damaged. Schooners from Curaçao, in the past, carried a great deal of the Colombian coffee to Curaçao.

Colombian Bucaramangas, from the Department of Santander, go via the Magdalena River to the Atlantic ports. The Ocañas, from North Santander, mostly reach the Magdalena by over-head cable-way. Girardots, from Cundinamarca; Tolimas, from the Department of that name; Hondas, from the same Department; and most of the Medellins, from the Department of Antioquia, are shipped via the Magda-

lena to the Atlantic ports in the north. The Manizales are mostly shipped by rail to Buenaventura, the Pacific port on the West Coast of Colombia, although some go by the Mariquita aerial cable-way to the Honda railway, and thence to the Magdalena. Some Medellins from the southern part of Antioquia also go out via the Manizales cable-way. Practically the entire Manizales crop, including that of Pereira and the Risaralda Valley is shipped to Buenaventura. Coffee from formerly remote points like Anserma and Rio Sucio now goes out by motor and rail. Little coffee is shipped on the Cauca River; all the Armenias, Sevillas, Cauca, and Popayans reach Buenaventura by rail.

A stock and commodity exchange was recently organized in Bogota, with special departments to deal in coffee, sugar, wheat, tobacco, cocoa, and hides. The unit of operations in coffee is a bag of 70 kilograms net (154.32 lbs.), in standardized

packing. For the sale of coffee in *pergamino* the unit is the arroba of twelve and one-half kilos (27.557 lbs.), packed in sacks of the purchaser. The minimum transaction is 50 sacks of the same mark and type. If in *pergamino* it is 250 arrobas.

#### *Marks Indicating Origin*

Colombian Law 76 of 1931 vested the National Federation of Coffee Growers with the task of classifying the different qualities of coffees produced in each Department, indicating the characteristics of each group and determining the marks which the different grades shall carry, according to their respective qualities and origin. This was amplified by Presidential Decree 1461 of 1932, which requires that all coffee originating in Colombia when shipped abroad must be marked either "Café de Colombia" or "Producto de Colombia," which may be imprinted in the language required by the country of destination or by commercial convenience. Each bag must also have in the center, on both sides, a vertical band of three parallel stripes; the middle one green and the outer ones red.

Bags of coffee for export must bear all

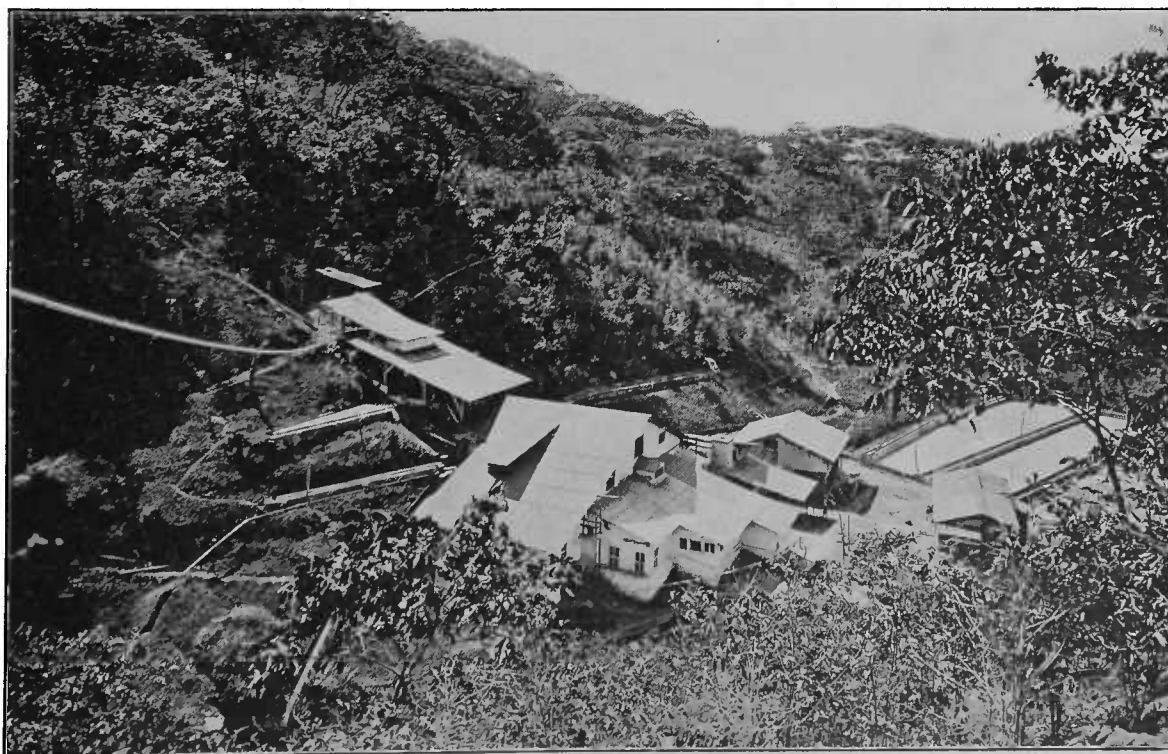


TRANSFERRING COFFEE FROM CARS TO STEAMSHIPS,  
PUERTO COLOMBIA

the marks required by the foregoing laws.

The classes and gradings for Colombian coffee, which must appear on the bags immediately after the mark of origin, are:

**SUPREMÓ.** Large, flat, uniform beans, properly selected, without any mixture of medium



TRANSPORTING COFFEE BY PIPELINE ON THE HACIENDA CININNATI, SANTA MARTA, COLOMBIA



NETS CARRYING TWENTY-FIVE BAGS ARE USED FOR LOADING COFFEE AT BUENAVENTURA

beans or "Caracol," and carefully prepared. The selection must be made from the first grading obtained in the classifying machines.

**EXTRA.** Flat, medium-sized beans, well selected with or without mixture of "Caracol."  
**CARACOL.** The bean or variety known under this name; large and medium-sized beans (firsts and seconds) duly selected.

**EXCELSO.** The qualities corresponding to "Supremo" and "Extra" types mixed, and may or may not include coffees of the "Caracol" type.

**SEGUNDA.** Small and sound beans properly prepared and picked, and can be mixed or not with peaberries of such type which, on account of their inferior size, cannot be included in the "Caracol" type.

**CONSUMO.** Small beans after the removal of the superior classes, which go under their respective types; can have such imperfections as crumpled, shrivelled, broken, or white beans, but without black beans or other foreign matter or coffee residues.

**PASILLA.** The type "Consumo" with up to 50 per cent of dark or black beans and without mixtures of foreign matters or the residues, which is the last product of the classifying machine.

**MARAGOGIPE.** Coffee of this variety, properly sorted.

#### *Coffee in Parchment*

**PRIMERA.** Coffee in parchment, carefully prepared, sorted, and of uniform quality.

**SEGUNDA.** Coffee in parchment, unassorted.

**MARAGOGIPE PRIMERA.** Parchment coffee of this variety, carefully prepared, sorted, and of uniform color.

**MARAGOGIPE SEGUNDA.** Parchment coffee of this variety, unassorted.

The coffee inspectors at the ports of Bar-

ranquilla, Cartagena, and Buenaventura are vested by the Decree with authority to enforce its provisions. The same authority is enjoyed by the superintendents and inspectors of the licensed warehouses of the National Federation of Coffee Growers of Colombia, or the branches or agencies of these warehouses.

All coffee exporters are required to deliver to the coffee inspector at the point of departure, bills of lading that enable him to determine the origin of the shipment, etc. If found O.K. the inspector signs a verification in triplicate, giving one copy to the exporter.

Coffee inspectors, and other employees of the National Federation who are charged with the duty of enforcing the Decree, are required to give bond up to \$2,000, Colombian currency, against any damages caused by mal-fulfillment of their duties.

#### *Coffee Buying in Venezuela*

The leading port for the exportation of Venezuelan coffee is Maracaibo, situated on the west shore of Lake Maracaibo, about 25 miles from the Caribbean Sea. Through that port also is exported part of the coffee produced in the District of Cúcuta, Colombia, and most of the coffees from the well-known Andean States of Trujillo, Tachira, and Mérida in Venezuela.



THE "GRAVITY" METHOD OF LOADING COFFEE AT BUENAVENTURA—WHEN THE TIDE IS LOW





PACK-MULE TRANSPORT IN VENEZUELA

Caracas, through its sea port La Guaira, ranks next as a Venezuelan coffee port and Puerto Cabella comes third.

The business of buying coffee for export is concentrated largely in the hands of German firms that have been established in the country for many years.

During the European war, 1914-18, and when Brazil lost a great part of her crop in 1919, the German firms stored large quantities of coffee, acquired at low prices, which they were in a position to dictate, afterward selling the coffee at a handsome profit.

The bulk of the coffee is transported by pack-mule from the plantations to the market towns, and thence to the ocean ports.

#### *Venezuelan Coffee Prices*

The first coffee raised in Venezuela, in the time of José Antonio Mohedano who introduced it at Chacao in 1784, was sold for 120 bolivars per quintal of 46 kilos, or



DONKEY COFFEE TRANSPORT ON THE WAY FROM HARAR TO DIRE-DAOUA, ETHIOPIA

approximately \$23.00 per 100 pounds. In 1808 the price was Bs. 80. From 1812 to 1814 the price of coffee fell to Bs. 12 per quintal, on account of the European blockade, but the small lots that could be smuggled into the Europe of Napoleon I brought prices as high as Bs. 200 per quintal.

From 1816 to 1860 the price of Venezuelan coffee suffered heavy fluctuations, ranging from Bs. 24 to Bs. 100 per quintal. The Franco-Prussian war sent it to Bs. 120 in 1870. From 1901 to 1914, prices varied from Bs. 36 to Bs. 80. At the time this is written, coffee is quoted in Venezuela at Bs. 140 to Bs. 145 per 46 kilos, or approximately \$26.92 to \$27.88 per 100 pounds.

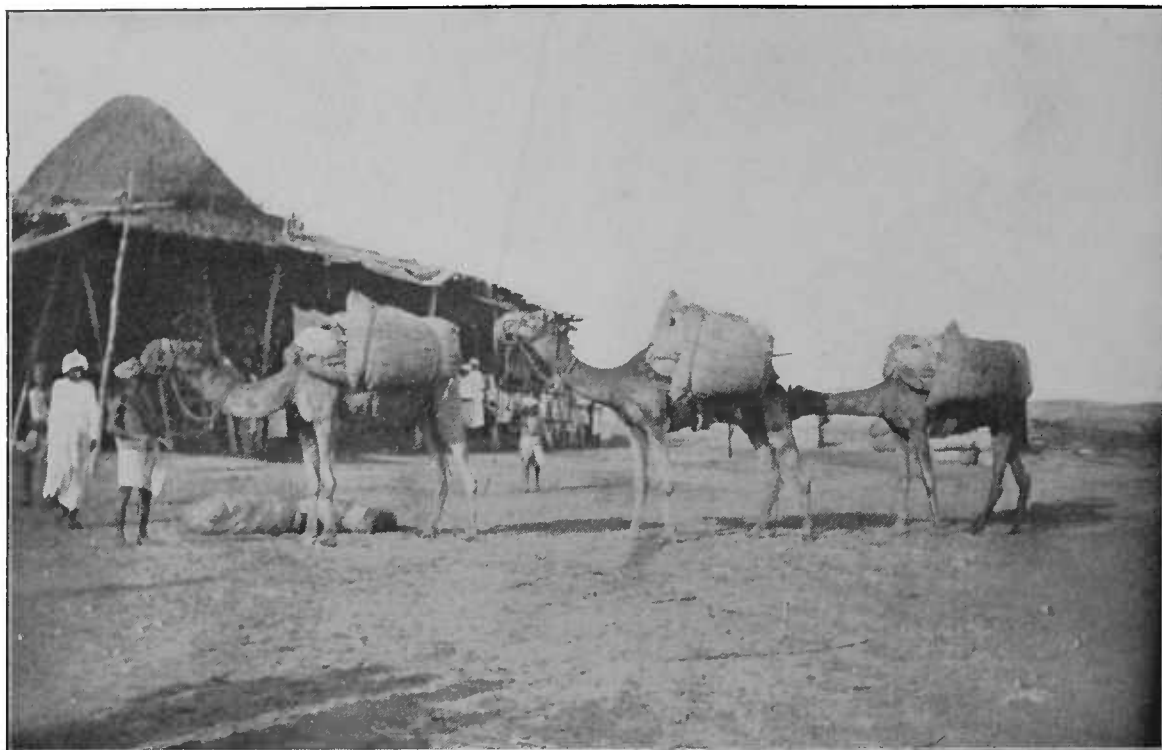
#### *Buying Coffee in Ethiopia*

Coffee is generally grown in Ethiopia by small farmers, who mostly finance themselves and sell the crop to native brokers,



COFFEE CAMELS IN THE CUSTOM-HOUSE, HARAR

who act as representatives of foreign houses in the larger trading centers. Trading methods between farmer and broker are not much more than the old system of barter. In the southwestern section, where the Ethiopian coffee grows wild, transport to the nearest trading center is by mule train, and not infrequently by camel back. In the Harar district, the women of the farmers living near Harar, the market center, carry the coffee in long shallow baskets on their heads to the native brokers. In the more remote places the coffee farmer waits for the broker to call on him. From the town of Harar the coffee is transported



COFFEE CAMEL TRAIN ARRIVING AT THE HODEIDA CUSTOM-HOUSE FROM THE INTERIOR OF YEMEN

by mule or camel train to Dire-Daoua, whence it is shipped by rail to Jibuti, to be sent by direct steamers to Europe, or across the Gulf of Aden to Aden in Arabia.

Ten different languages are spoken in Harar. In order successfully to engage in the coffee business there, it is necessary either to become proficient in all these tongues, or to engage some one who is.

When the coffee is brought, partially cleaned, into Harar by donkey or mule train, it is first taken to the open air custom-house (coffee exchange) in the center of the town, where duty (in coffee) is ex-

acted by the local government. As soon as the native dealer has released to him what remains of his shipment, he takes it out of the custom-house enclosure and disposes of it through the native brokers, who have their little "office" booths stretching in a long line up the street just outside the custom-house entrance.

There, a brokerage charge of one piaster per bag is paid by the buyer, and the coffee then becomes the property of the European merchant. In some cases it is put through a further cleaning process; but usually it is shipped to Jibuti or Aden uncleaned. Arriving at Jibuti, there is an ad valorem duty to pay. At Aden, another tax has to be paid to the British authorities.

#### *Buying Coffee in Arabia*

Most of the coffee in Arabia is grown in almost inaccessible mountain valleys by native Arabs, and is transported by camel caravan to Aden or Hodeida, where it is sold to agents of foreign importing houses. Mocha, once the principal exporting city for coffee, was abandoned as a coffee port early in the nineteenth century, chiefly because of the difficulty of keeping the roadstead of the harbor free from sandbars.

In Aden there is a kind of open-air cof-



SELLING COFFEE AT ADEN, ARABIA, BY TAPPING HANDS UNDER COVER

fee "exchange," as in Harar, where camel trains unload coffee from the interior. The European coffee merchant does not frequent it, but is represented by native brokers, through whom all coffee business is transacted. This native broker is an important person, and one of the most picturesque characters in Aden. He receives a commission of one and a half per cent from both buyer and seller. Certain grades of coffee are purchasable only in Maria Theresa dollars; so a knowledge of exchange values is essential to the broker's calling.

In making coffee sales, the negotiations between buyer and seller are carried on by means of finger taps under a handkerchief. The would-be purchaser reaches out his hand to the seller under cover of the cloth and makes his bid in the palm of the seller's hand by tapping his fingers. The code is well understood by both. Its advantage lies in the fact that a possible purchaser is enabled to make his bid in the presence of other buyers without the latter knowing what he is offering.

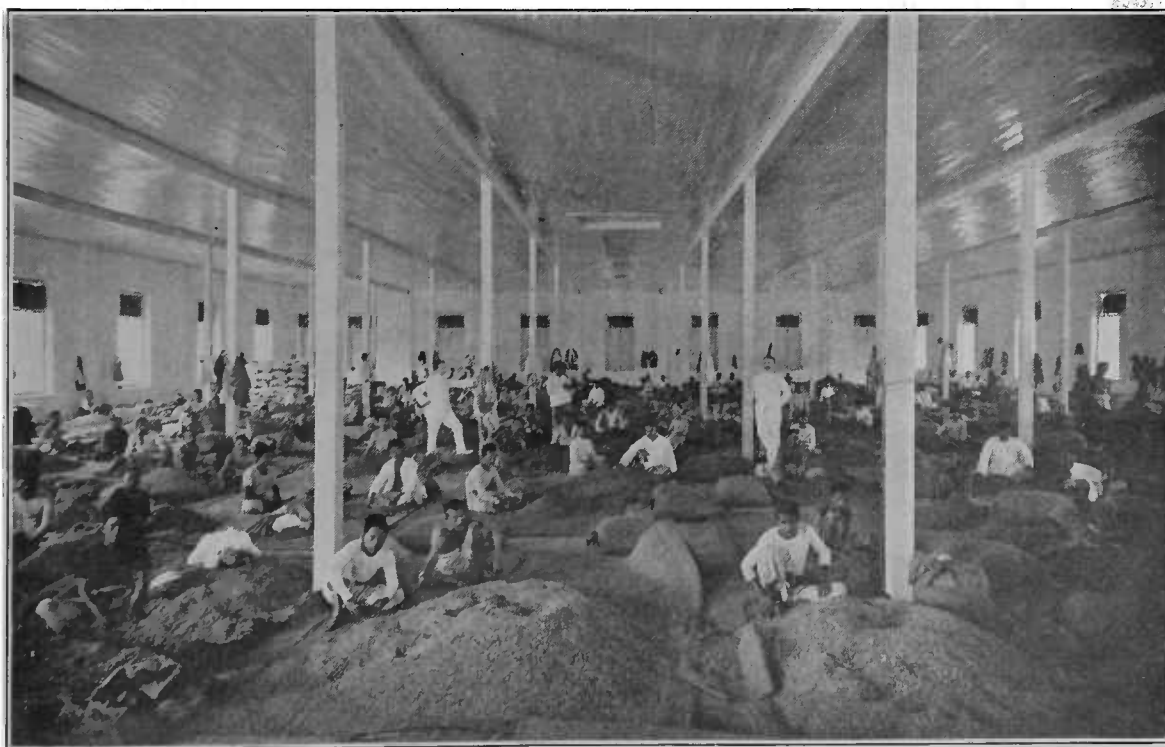
#### *Buying Coffee in Netherlands Indies*

In the Netherlands Indies cultivation of *Coffea arabica* has diminished, the decay of the industry beginning when Brazil and



COFFEE FROM GODOWN TO STEAMSHIP, SUMATRA  
Lower—Shipment from godown. Upper—Lighter transport to steamer.

Central America became the dominant factors in the green market. Not so many years ago coffee-growing and coffee-trading were virtually Government monopolies. Under Government control each native family was required to keep from six hundred to



DOUBLE-PICKING COFFEE IN A COFFEE CLEANING ESTABLISHMENT AT PADANG, SUMATRA



LOADING PARCHMENT COFFEE ON BARGES FOR DISPATCH TO CURING WORKS, SOUTHERN INDIA

a thousand coffee trees in bearing, and to sell two-fifths of the crop to the Government. It was also compulsory to deliver the coffee cleaned and sorted to the official godowns, and to sell the crop at fixed prices—nine to twelve florins per picul previous to 1874, although forty to fifty florins were offered in the open market. Later, the price was advanced; until about 1900 the Government paid fifteen florins per picul for coffee in parchment.

Coffee from private estates, not under Government control and operated by European corporations or individuals, succeeded the Government-monopoly coffee. Crops are sold by public tender, usually on or about January 28 of each year. If the owners do not get the price they desire in Batavia, Padang, or Sibolga, the coffee is sent to Amsterdam for disposal. Some coffees always are sent to Holland because the directors of the company get a commission on all sales there, and also because the coffees are prepared especially for the Dutch market. The Hollander wants his coffee blue-green in color.

#### *Some Record Coffee Cargoes*

With its superior loading and shipping facilities, Brazil has been able to send extraordinarily large cargoes of coffee to the United States since the development of

large, modern freight-carrying steamships. While 75,000 or 90,000 bag cargoes were the average prior to the outbreak of the World War in 1914, numerous cargoes of more than 100,000 bags have been recorded. The record is held by the steamship "Caixas" of the Lloyd-Brasileiro Line which unloaded 150,000 bags at New York in March, 1919. Other cargoes in excess of 100,000 bags, in the order of their size, were unloaded by the steamship "Parnahyba," 137,114 bags in February, 1932; "Bjornstjerne Bjornson," 136,424 bags in November, 1915; "Dakotan," 136,387 bags, January, 1917; "Parnahyba," 133,719 bags, May, 1932; "Norse Prince," 128,252 bags, April, 1909; "Rosetti," 125,918 bags, December, 1900; "American," 124,212 bags, October, 1916; "Wascana," 108,781 bags, March, 1915; "Wagama," 105,650 bags, October, 1916; "Santa Cecilia," 105,500 bags, November, 1916; and "Pacific," 105,000 bags, January, 1918.

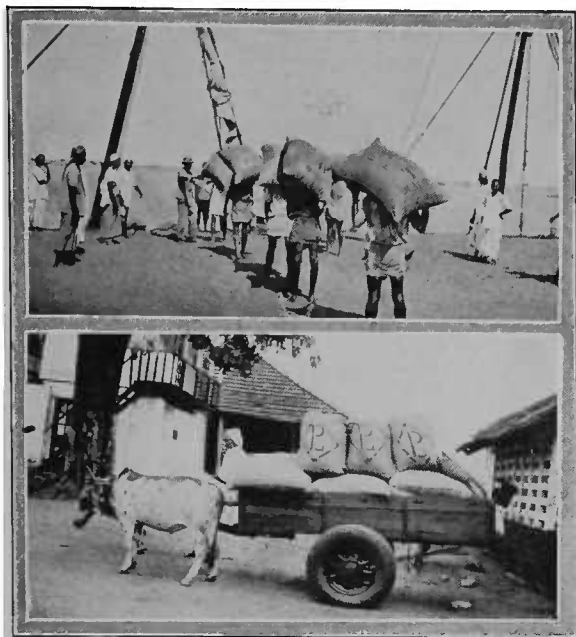
#### *Transport Overseas*

Sailing ships which once brought green coffee to the consuming markets have wholly given way to speedier and more capacious modern steamships. Because of its large consumption, a steady stream of steamships is always on the way to the markets of the United States. The majority of these unload at New York, which in 1934 received about 49 per cent of all the coffee imported into this country. New Orleans came next with about 27 per cent, and San Francisco third, with about 11 per cent.

The approximate time consumed in transporting green coffee overseas from the principal producing countries to the United States by steamship is shown in the table on the next page.

#### *Java Coffee "Ex-Sailing Ships"*

Up to 1915 it was the custom to ship considerable Java coffee to New York in slow-going sailing vessels of the type in favor a hundred years ago. Java coffees "ex-sailing ships" always commanded a premium because of the natural sweating they experienced in transit. Attempts to imitate this natural sweating process by steam-heating the coffees that reached New York by the faster-going steamship lines,



TRANSPORTING COFFEE, SOUTHERN INDIA  
Upper—Loading coffee onto lighters. Lower—Bullock cart with pneumatic tires.

and interference therewith by the Pure Food authorities, caused a falling off in the demand for "light," "brown," or "extra brown" Netherlands Indian growths; and gradually the picturesque sailing vessels were seen no more in New York harbor. At the end they were mostly Norwegian barks of the type of the "Gaa Paa."

It usually took from four to five months to make the trip from Padang or Batavia to New York. Crossing the Equator twice, first in the Indian Ocean, then in the South Atlantic, the trip was more than equal to circumnavigating the earth in our latitude. In the hold of the vessel the cargo underwent a sweating that gave to the coffee a rare shade of color and that, in the opinion of coffee experts, greatly enhanced its flavor and body. The captain always received a handsome gratuity if the coffee turned "extra brown."

The demand for sweated, or brown, Javas probably had its origin in the good old days when the American housewife bought her coffee green and roasted it herself in a skillet over a quick fire. Coffee slightly brown was looked upon with favor; for every good housewife in those days knew that green coffee changed its color in aging, and that, of course, aged coffee was best.

And so it came about that Java coffees were preferably shipped in slow-going Dutch sailing vessels, because it was desir-

COFFEE TRANSPORTATION TIME

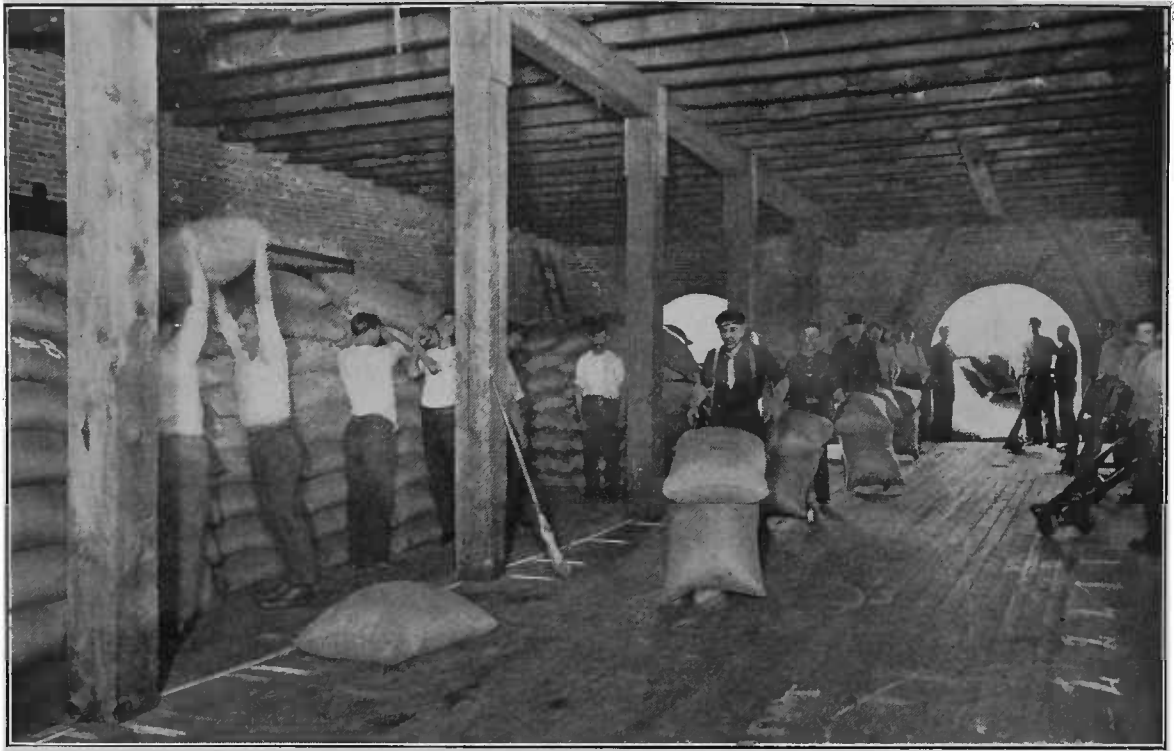
Rio de Janeiro to New York	13	to 20	days
Santos	14	22	"
Victoria		18	"
Paranagua	24	25	"
Bahia		16	"
Recife		15	"
Angra dos Reis		14	"
Puerto Colombia		11	"
Cartagena		10	"
Maracaibo	10	11	"
Puerto Cabello	8	9	"
La Guaira	7	8	"
Costa Rica		10	"
Salvador	10	18	"
Mexico	9	14	"
Guatemala		11	"
(Puerto Barrios)			
Haiti		7	"
Puerto Rico	5	6	"
Guadeloupe		10	"
Hawaii		28	"
(via Panama Canal)			
Java	50	58	"
(via Suez)			
Sumatra		50	"
(via Suez)			
Singapore		50	"
(via Suez)			
So. India		50	"
(via Suez)			
Aden		45	"
(via Suez)			
Rio de Janeiro to New Orleans		21	"
Santos		23	"
Victoria		19	"
Colombia		12	"
Venezuela		8	"
Salvador		12	"
Nicaragua		12	"
Costa Rica		7	"
Guatemala		4	"
Mexico		3	"
Haiti		5 1/2	"
Rio de Janeiro to San Francisco		38	"
Santos		40	"
Venezuela		15	"
Colombia		15	"
Salvador	8	10	"
Nicaragua		10	"
Costa Rica		13	"
Guatemala	7	10	"
Mexico	4	6	"
Hawaii		7	"
Singapore		40	"
So. India		47	"

able to have a long voyage under the hot tropical sun suitably to sweat the coffee on its way to market and to have it a handsome brown on arrival. The sweating fre-

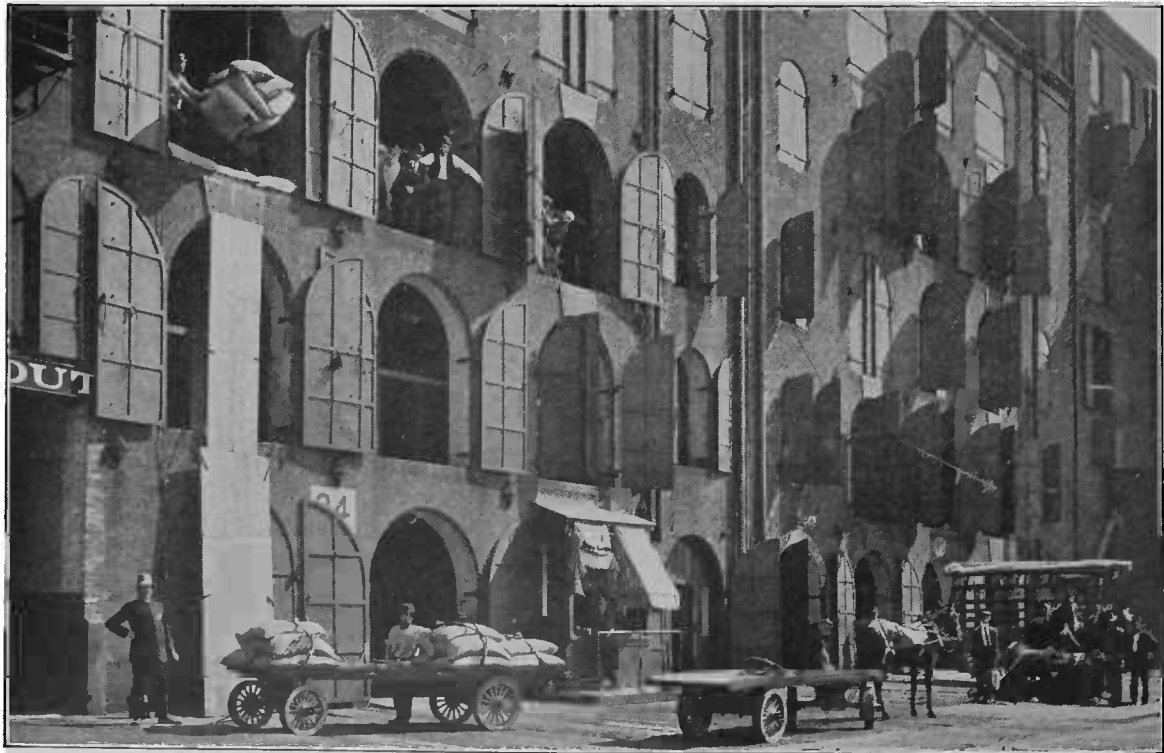


LOADING COFFEE ON LIGHTER, SOUTHERN INDIA





CLASSIFYING AND STORING COFFEE BY MARKS AND CHOPS IN THE WAREHOUSE



HOISTING COFFEE INTO THE STORAGE WAREHOUSES ADJOINING THE BROOKLYN PIER  
RECEIVING AND STORING COFFEE AT NEW YORK

quently produced a musty flavor which, if not too pronounced, was highly prized by experts. When the ship left Padang or Batavia the hatches were battened down, not to be opened again until New York harbor was reached.

Many of the old-style Dutch sailing vessels were built somewhat after the pattern of the "Goed Vrouw," which Irving tells us was a hundred feet long, a hundred feet wide, and a hundred feet high. Sometimes she sailed forward, sometimes backward, and sometimes sideways. After dark, the lights were put out, all sail was taken in, and all hands turned in for the night.

The last of the coffee-carrying sailing vessels to reach the United States was the bark "Padang," which arrived in New York on Christmas day, 1914.

#### *Handling Coffee at New York*

The handling of the cargoes of coffee when they arrive at their destination is a source of wonder to the layman. There is probably no better place to study the handling of coffee than in New York City—the world's largest coffee center. Millions of bags of coffee pass into consumption every year through its docks, and scarcely a day goes by when there are not one or more ships discharging coffee upon the docks lining the Brooklyn shore, the center of the coffee-warehouse district for New York. In 1934, the New York Dock Company alone had 105 storage warehouses, both bonded and free, having a total capacity of more than 44,000,000 cubic feet; and 34 piers, the longest measuring 1,193 feet and containing more than 175,000 square feet. These piers have a total deck space of sixty-one and a half acres. The wharfage distance is more than nine and a third miles. More than twenty steamship lines berth their vessels there regularly, and many of them are coffee ships.

Warehouses of the New York Dock Company are served by the New York Dock Railway, which, by means of its own floating equipment, maintains direct daily connections with all trunk lines entering the port of New York, and the flat New York freight rates generally apply.

Although coffee, whether in parchment, hulled, roasted, or roasted and ground, is admitted to the United States free of duty, it is subject to practically the same for-

malities as dutiable goods. Before a cargo of green coffee can be "broken out," a Government permit to "land and deliver" must be placed in the hands of the customs inspector on the dock. This done, the ship's samples, which consist of the samples sent by the exporter to the importer, are taken to the United States appraiser's office for inspection, and are then delivered to the importer's representative. Meanwhile the shipping documents covering the cargo, including bills of lading and consular invoices, have been sent to the post office for delivery to banks and bankers' agents, who check and deliver them to the customs officers for entry. The Government requires that this entry shall be made within forty-eight hours of the vessel's arrival, else the cargo will be stored in a United States bonded warehouse under what is known as "general order" which makes the consignee liable for storage and cartage charges.

When a coffee ship arrives in New York, not much time is lost in discharging the cargo. As soon as the vessel is securely moored to the pier, and the Government's permission to "land and deliver" is secured, the hatches are removed, the coffee is hauled out of the hold by block and tackle and swung off in slings to the pier, where dock laborers carry the bags to their proper places. If each cargo consisted of one consignment to a single importer, and contained only one variety of coffee, unloading would be a comparatively simple affair. In general practice, however, the cargoes consist of a large number of consignments and a variety of grades, necessitating a careful sorting as unloading progresses. Accordingly, even before the unloading begins, the dock is chalked off into squares, each square having a number, or symbol, representing a particular consignment. As the bags come up out of the hold, the foreman of the laborers, who has a key to the brand marks on the bags, indicates where each bag is to be placed. Coffee to be reshipped, either by lighter or rail, is heaped in piles by itself until loaded on the lighters or freight cars.

The next step is to transfer the cargo to the warehouse, and to separate each consignment according to the various kinds of coffee making up the invoices. When the importer gives his orders to store, he sends also a list of the different kinds of coffees in his consignment, called "chops" by the



AIRPLANE VIEW OF THE NEW YORK DOCK COMPANY'S PIERS AND WAREHOUSES

This is the Fulton street section of the Brooklyn waterfront, where more than half the coffee received in New York is unloaded. The storage warehouses are to be seen back of the piers.

trade, with directions how to divide the shipment. To do this, the floor of the warehouse is chalked off into squares, as was done on the dock; but now the numbers, or symbols, in each space indicate the chops in each invoice, or consignment.

The importer naturally is eager to sample the newly arrived coffee. Sampling is



TESTER AT WORK, BUSH TERMINAL, NEW YORK

generally done on the dock by trained warehouse employees, who are equipped with coffee triers, sampling instruments resembling apple-corers, which they thrust into the bags. The instrument is hollow, and the coffee flows into the hand of the sampler, who places each sample in a paper bag which is marked to indicate the chop. The total sample of each chop usually consists of about five pounds of coffee, drawn from 15 to 25 bags, which the importer compares with the exporter's sample.

When sampling for trade delivery, about two-thirds of the bags in a chop are tried. But when sampling for delivery on a Coffee Exchange contract, every bag must be tested, and care taken that each chop is uniform in color, kind, and quality. Coffee for Exchange delivery must be stored in a warehouse licensed by the Exchange; and the warehouseman is responsible for the uniformity of grade of each chop.

When approximately ninety per cent of the cargo has been unloaded and stored, the warehouse issues what is known as the "last bag notice." In the majority of cases the coffee has been sold before arrival; and on receipt of the last bag notice, the importer can transfer ownership of the coffee and save interest.

In a cargo of 75,000 to 100,000 bags of coffee that has been hurriedly loaded in the producing country and unloaded at destination in equal haste, a small portion of the cargo is almost certain to be damaged. Generally the damage is slight. If a bag is torn or stained, the coffee is placed in a new bag. If the contents have become mildewed, it is taken to a warehouse for reconditioning; while the sound coffee is thoroughly aired to remove the odor and is then placed in a clean bag. The reconditioned lot is put into a separate package and forwarded to the buyer with a "reconditioning statement" that shows what has been done.

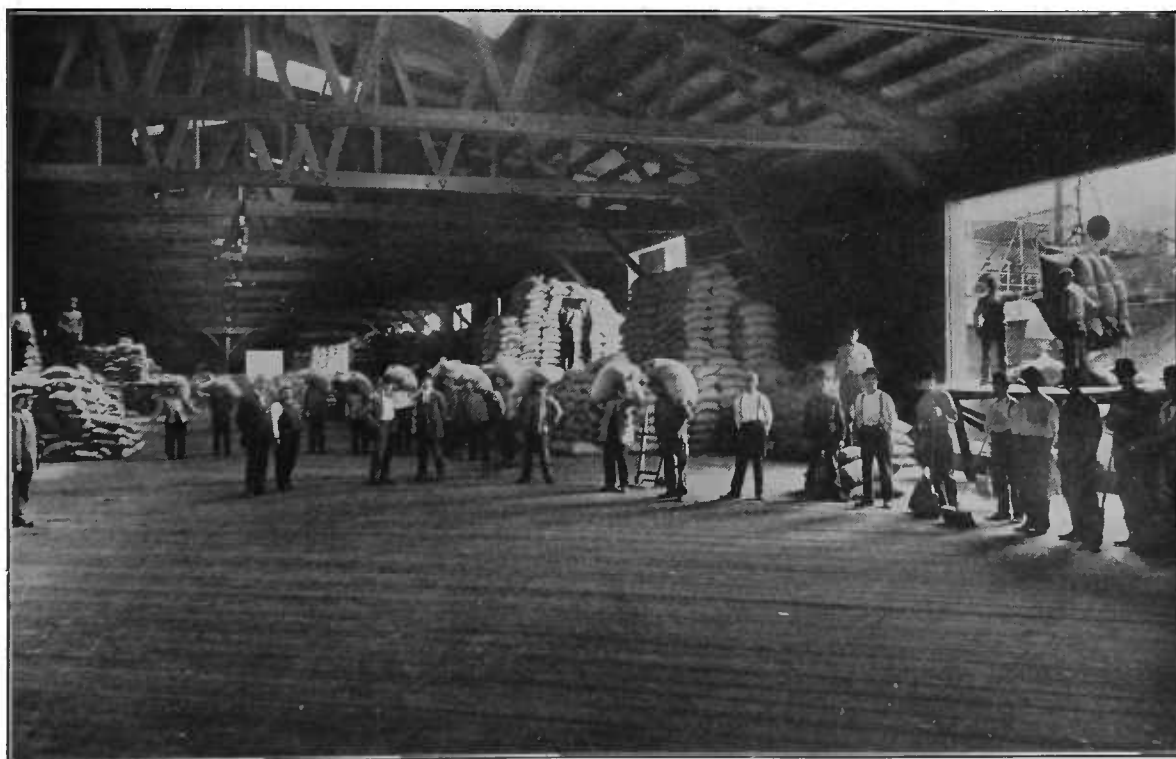
Bags that have been torn in transit, and parts of their contents spilled, are called "slacks." These are weighed as they arrive on the dock by a licensed public weigher; and a sufficient quantity of the coffee remaining on the floor of the ship's hold is put into the bag to make it of the proper weight. The expense of reconditioning and rebagging is generally borne by the marine insurance companies. When the entire cargo is unloaded, and the slacks and bad-order bags are weighed and marked, the warehouseman tallies up the records of his clerks, and renders a corrected chop list to the consignee.

Another district along the water front of Brooklyn where coffee is discharged in large quantities is that between Thirty-third and Forty-fourth Streets, south Brooklyn, occupied by the Bush Terminal Stores. This plant is laid out with railroad spurs on every pier, so that its own transfer cars, or the cars of the railroads running out of New York, can be run into the sheds of the docks where coffee is being discharged from the ships. The methods employed by the Bush Terminal are similar to those just described, except that all the coffee is handled by electrically-manipulated cars or trucks, in some instances the powerful little tractors hauling many "trailers" to various parts of the yards.

#### *Handling Charges at New York*

Before the World War, it cost approximately one-half cent a bag to handle green coffee from the vessel to warehouse and in storage in New York. The rate advanced nearly one hundred per cent in the latter part of 1919, then dropped slightly, although it is still above the pre-war price. Coffee handling charges are shown in the table at the top of the next page.

The warehousemen in 1919 charged four cents per bag for loading into railroad cars.



UNLOADING COFFEE AT ONE OF THE COVERED PIERS OF THE NEW YORK DOCK COMPANY

COFFEE HANDLING CHARGES AT  
NEW YORK

	<i>Pre-war prices</i> <i>Cents</i> <i>per bag</i> <i>(132 lbs.)</i>	<i>Prices 1934</i> <i>Cents</i> <i>per bag</i> <i>(132 lbs.)</i>
Storage .....	.03 to .04	.05
Labor .....	.03 to .04	.08
Sampling for damage..	.01	.01
Cleaning .....	.15	.20
Dumping and mixing (incl. sweepings)...	.10	.20
Transferring coffee from floor to floor or from store to store .....	.04	.08
Marking (minimum charge 25¢) .....	.01	.01
Labor at ship .....	\$9 per M.	\$15 per M.

This charge was discontinued in 1921. The cost of weighing increased from two and one-half cents per bag in 1914 to four and one-half cents in 1919, and then dropped to the present price of three to three and one-half cents. Other handling charges at the port of New York are shown in the second table on this page.

A plan intended to cut down handling costs in New York, and to expedite deliveries, was inaugurated by the National Coffee Roasters Association at the beginning of 1920. The Association formed a freight-forwarding bureau, and invited members to have their coffee shipments handled through the bureau. The charges for forwarding direct importations are two cents per bag. Cartage charges vary from six to eighteen cents per hundred pounds. Claims are handled without charge.

*Terms and Conditions of Sale*

The terms and conditions under which green coffees are imported and sold have been quite definitely established. Contracts of purchase and sale are so worded that the buyer and seller are supposed to be jointly and equally protected.

Brazil imports are financed on a 90-day basis against bankers' letters of credit; while Milds are sold basically on terms of 4 months' notes, which are supposed to be, but seldom are, furnished by the purchaser. With the exception of cost and freight purchases, the general terms of settlement involve full payment one way or another within 30 days from the date of the invoice, with the added stipulation of cash as removed from the seller's possession.

*Cost and Freight Purchases*

The bulk of the coffees imported into this country are Brazils purchased on a cost and freight basis. A cost and freight purchase of Brazil coffees requires the buyer to furnish the seller a confirmed letter of credit, issued by a bank satisfactory to the seller, against which credit drafts are drawn on the issuing bank at 90 days' sight, and payable in New York at maturity. The letter of credit usually stipulates that such drafts must be accompanied by the seller's invoice, a U. S. Consular invoice, and a bill of lading showing that the shipment has been made within the period named in the letter of credit. These details being complied with, the bank accepts the draft payable 90 days after the date of acceptance. It is necessary, although the letter of credit does not so require, that the seller furnish a certificate attesting that the merchandise has not been adulterated in any way, and is prepared in accordance with the provisions of the Food and Drugs Act of the United States. This certificate is required to prevent the shipment of low grade coffees which would be refused entry at United States ports. This document is really a U. S. Consular form and is stamped by the U. S. Consul at the port of embarkation.

An important point for the purchaser to consider is that a confirmed letter of credit can only be cancelled by the joint consent of both parties to the contract, and that drafts drawn under such credits must be honored by the bank under any and all circumstances, provided of course, that the shipping documents are in order.

OTHER HANDLING CHARGES, 1934

	<i>Cents per bag</i> <i>(132 lbs.)</i>
Drawing samples, each 10 lbs.....	.20
Grading for variations .....	.04
Matching in, 5 bags and over.....	.12
Reducing or evening off slack.....	.09
Transfer from old to new bag.....	.10
Trucking and chopping in store....	.04
Collecting and preparing sweepings..	.25
Delivering 1st sample below City Hall, N. Y. ....	1.00
Each additional package .....	.10
New bags:	
Brazil .....	.15
Maracaibo .....	.15
Mexican, large .....	.25
Mexican, small .....	.20
Old bags .....	.08





THE BUSH TERMINAL SYSTEM OF DOCKS AND WAREHOUSES

Much of the green coffee received in New York is discharged and stored here, at one of the most modern waterfront and terminal developments in the world.

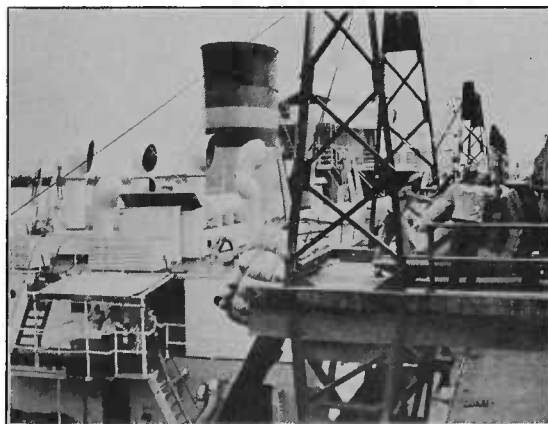
On a cost and freight purchase, the seller undertakes to pay the freight, but it is the trade custom for the sellers to invoice the merchandise at the price at which the coffees are sold, less the ocean freight, which procedure requires the purchaser to pay the freight on arrival here. The purchaser, therefore, should insure the freight, as well as the coffees, because under most maritime bills of lading covering coffee imports, other than Brazil's, the freight is considered earned, even though the ship be lost at sea and the merchandise never delivered.

#### *Ship Fillings for Lost Sound Coffee*

The U. S. Custom House fees and the dock charges of \$15 per 1,000 bags are for the account of the buyer. The coffees are billed on the shippers declared weights of 132 net lbs. per bag and any losses in weight in transit are borne by the buyer. According to trade custom, the c. & f. buyer must also accept ship fillings from the steamship agents in lieu of sound coffees, if any of the bags in his purchase are torn in transit. A peculiar feature of this arrangement is that most of the steamship companies consider as slack bags only those that are noticeably slack, that is, bags from which so much coffee has been spilled that the

bag is clearly underweight. The companies undertake to deliver sufficient ship fillings to offset the total shrinkages from all these slack bags and, if they do so, they often consider their obligations to the consignees fulfilled. They seldom make apportionment of ship fillings to cover the bags from which only a pound or so has sifted but not enough to make the bags noticeably slack. Again, they make their calculations of slacks on the basis of bags weighing 132 lbs., whereas that is the net weight of the bags, and they should weigh gross 133.125 pounds.

Brazil ship fillings are seldom salable



Mississippi Shipping Co.  
UNLOADING COFFEE FROM STEAMSHIP TO DOCK WAREHOUSE, NEW ORLEANS



Mississippi Shipping Co.  
TRANSPORTING COFFEE BY MOTOR TRUCK AND  
TRAILERS IN STORAGE SHED, NEW ORLEANS

above the value of Rio 7s, therefore the importer of high-grade Santos takes quite a loss on his slack delivered bags.

A so-called "good faith" clause appears in a large percentage of Brazilian c. & f. contracts, and the fact that so many buyers are satisfied to rely on the integrity of the shipper, also evidences good faith on the purchaser's part.

A guaranteed contract is one containing a description guaranteed by the shipper. The old saying is ever true that "a contract is no better than the parties to it"; therefore, guarantee or no guarantee, the purchaser should first and always consider the reputation of the shipper to whom his order will be entrusted.

#### *Descriptions and Guarantees*

Mild coffees, and particularly Colombians, are not usually purchased on a cost



Mississippi Shipping Co.  
CLASSIFYING COFFEE BY MARKS AT NEW ORLEANS

and freight basis. If they are bought "to arrive," the time and place of shipment is specified, and, whether they are to be taken "ex. dock" or "in store," quality is based either on type or on sample, and the invoicing is usually done on landed weights.

#### *Marking of Coffee Imports*

The required marking of coffee entering the United States, as set forth in Article 509 (b) of the U. S. Customs Regulations, 1931, and as amended in 1934, is essentially as follows:

The marking required shall include the name of the country of origin. The term "country" is held to mean the political entity known as a nation: Provided, that the Department will designate the marking considered sufficient to indicate the country of



COFFEE TRANSPORT FROM DOCK TO RAILROAD IN  
NEW ORLEANS

origin in those cases where the name of the country is of such length that require such name would result in indistinct marking or no marking. However, colonies, possessions, or protectorates outside the boundaries of a mother country shall be considered separate countries.

#### *Examples of Marking*

On a selected list of coffee-producing countries, the Bureau indicates as acceptable marking the names of all American nations as known in English. The variant Bresil is allowed for Brazil. Sibolga and Padang (Sumatra) must be marked Sumatra, or Netherlands Indies; Kenya may be marked Kenya or British East Africa; Bukoba, Kilimanjaro, and Arusha shall be marked Tanganyika Territory or Tanganyika; British East Africa is sufficient for British East Africa; Abyssinia shall be marked Ethiopia, the same holding for Harar; Java may be marked Java, or Netherlands Indies. Marking of the



SHOWING HOW COFFEE IS STORED UNDER STEEL-COVERED SHEDS AT NEW ORLEANS

particular place of origin is required for Arabian coffee, as Aden, Bahrein Islands, Hadramaut, Kumait, Oman, Qatar, Baudi Arabia, Trucial Coast, or Yemen.

Marks of transshipment points are not required, and there is no objection to a mark indicating the brand.

#### *Handling Coffee at New Orleans*

Coffee ships are unloaded in New Orleans, the second coffee port in the United States, in about the same general manner as in New York. A notable feature is New Orleans' steel-roofed piers, where coffee can be stored until ready for shipment to the interior.

The Poydras Street Dock is reserved for coffee from Brazil; this coffee is unloaded in slings of not more than twelve bags each, then is placed on small trailer cars and moved to a central point, where it is assorted according to bill of lading marks and stacked in marked piles.

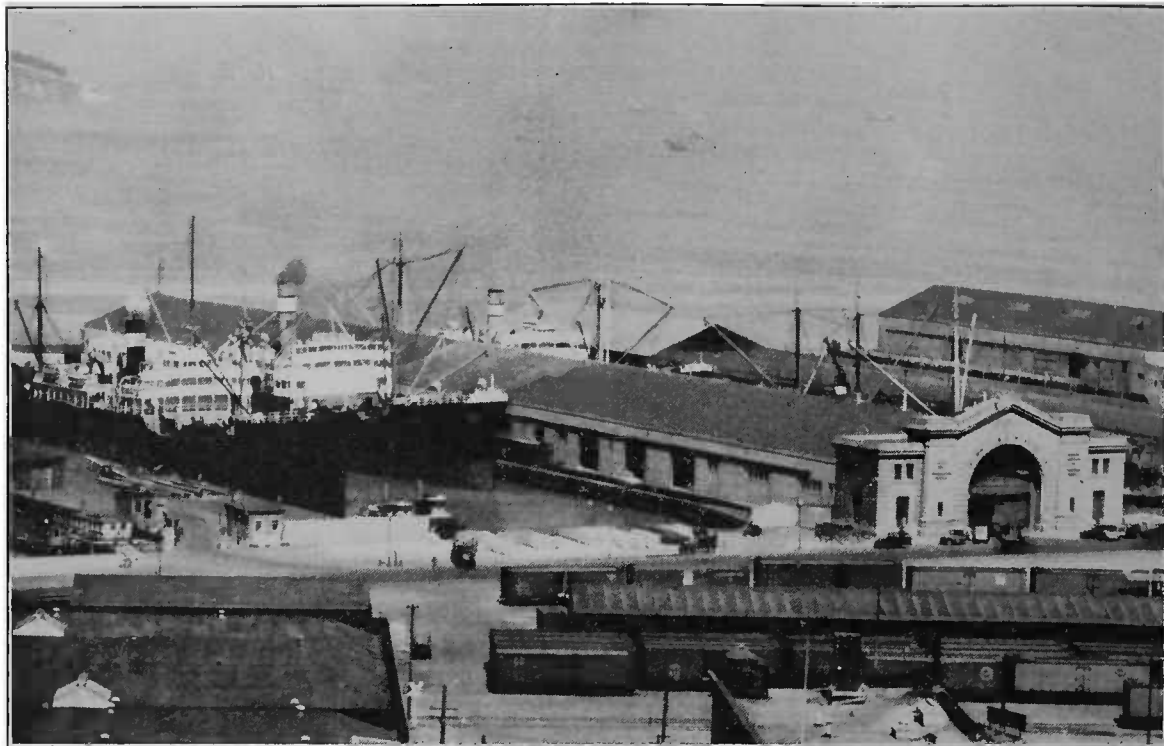
The Poydras Street Dock is a fire-proof, steel and reinforced concrete structure, two stories high, permitting unloading from ship to two floors simultaneously. The construction is such that motor trucks, transporting as many as 100 bags of coffee each, can be operated throughout both floors. It is claimed that, because of the

structural plan of the dock and its approaches, coffee can be unloaded, assorted, and moved faster than on any other coffee dock in the world.

Mild coffees are unloaded at the respective steamship-line docks, which are similar



COFFEE UNLOADING SCENES AT NEW ORLEANS  
*Upper*—Showing the relative positions of dock and storage sheds. —*Lower*—Unloading coffee into trailers for transportation to shed.



A COFFEE DOCK IN THE CITY OF SAN FRANCISCO  
Showing the water and rail connections for handling green coffee.

in construction to the Brazilian dock, but are of single-story height.

#### *Handling Coffee at San Francisco*

San Francisco ranks third in the list of United States coffee ports, having received its greatest development in the four years of the World War, when the flow of Central American coffees was largely diverted from European markets to the Californian port. In the course of these four years, the annual coffee imports increased from some 380,000 bags in 1914 to more than 1,000,000 bags in 1918. The bulk of these importations came from Central America, though some came from Hawaii, India, and Brazil and other South American countries.

Before the World War, Central American coffee growers were financed principally by Hamburg and London merchants and, to a lesser extent, by San Francisco coffee importers. During the War, however, San Francisco took over practically the entire burden of the financing, besides the function of marketing the crops. Consequently, the Central American trade became an intricate financial operation.

The system of Central American advances against future consignments continued for some years—often secured by mortgages on the plantations. Gradually, however, grades became standardized, and on the basis of these and known plantation marks purchases began to be made at fixed prices for future shipments, and ultimately replaced almost entirely consignment for shippers account. Today, brokers deal direct, to a limited extent at least, with Central American growers or exporters the same as they do generally in the case of Brazil coffees and to a lesser degree with Colombians.

Coffee arrivals are sampled on the wharves, where the authorities accord liberal facilities. On these samples, deliveries of sold coffees are accepted and, in the case of consignments, the importer or his broker effects sale "where is." The coffee is weighed and tared on the wharf, generally during the process of loading on trucks.

These operations are greatly facilitated by the fact that the wharves are spacious, well-lighted, and fully protected. A generous period of demurrage is granted, during which the coffee may change ownership one





ONE OF THE MODERN DEVICES USED IN SAN FRANCISCO FOR HANDLING GREEN COFFEE

or more times, and arrangements may be made for forwarding by rail or vessel to final destination.

Incoming ships unload by their own hoisting tackles, depositing sling-loads of coffee on four-wheeled trucks. These are hauled in trains by electric or gasoline motors to assigned locations on the wharf, according to ownership, marks, and quantities.

Although the dock floors are of concrete and clean, waterproof paper is spread over them and the coffee is piled thereon. The tiers are not more than eight bags high, so piling conveyors are seldom used.

The wharves, being of fire-proof steel and concrete construction, carry a minimum of fire risk. Ample ventilation obviates the possibility of contamination from other cargo.

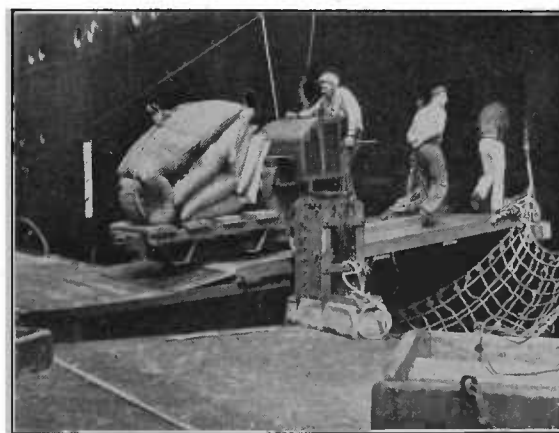
San Francisco possesses ample facilities for conditioning coffee and improving its quality and marketable state. There was a time when Central American coffees arrived in innumerable grades and classifications, with or without distinguishing counter-marks, and mostly in small chops, thus multiplying the number of samples and the technical difficulties of assorting them. At the same time many of the plantations in

Central America had no machinery for pulping or hulling coffee, while still others who had some available machinery preferred to have the processing done in the more efficient plants in San Francisco. Thus, much coffee arrived in *pergamino*. San Francisco readily met the requirements, and several warehouses still operate, though on a reduced scale, complete installations for coffee preparation.

These plants also have facilities for mixing on either small or large scale. Coffees that arrive too moist, or even more or less water logged, are expertly dried so as to preserve their inherent qualities. Even coffees that have suffered cargo contamination are entirely reconditioned.

#### *Europe's Great Coffee Markets*

Europe has three great coffee-trading markets—Havre, Hamburg, and Antwerp. Rotterdam and Amsterdam are also important coffee centers, but rank far below the others named. In point of volume of stocks, Havre led the world before the war; while in respect to commercial transactions, it ranked second, with New York first. In pre-war days, the largest part of the world's visible supply of coffee was stored in the Havre bonded warehouses, being available for shipment to any part of Europe on short notice, or even to the United States in emergencies. Even during the World War, this French port remained a powerful factor in international coffee trading, but today Hamburg carries far larger stocks than Havre. Coffee trading in Havre,



*Grace Line*

NEW COFFEE-HANDLING METHOD, SAN FRANCISCO  
The coffee is transported from ship to dock by electric truck through the side of the ship.





**THE CITY OF HAMBURG, WITH THE COFFEE EXCHANGE (X) IN THE FOREGROUND**

Hamburg, with its famous harbor, situated about 50 kilometers from the sea, is the natural port for the extensive Elbe district. With its quays of more than 50 kilometers total length, Hamburg is the largest port in Germany and the second on the Continent.



**HOW COFFEE IS HANDLED AT THE DOCKS IN HAMBURG**

A view of one of the modern Hamburg-American Line piers, where coffees arrive from the producing countries both for domestic consumption and for reshipment to all the lesser seaports of Northern Europe.

**WHERE NORTHERN EUROPEAN COUNTRIES GET THEIR COFFEE**

both Exchange and "spot" transactions, follows about the same general lines as in New York and the other great coffee markets. Coffee "futures" are dealt in on the Havre Bourse.

Green coffee is sold in London by auction in Mincing Lane. On arrival, it is stored in bonded warehouses, and is released for domestic use only when customs duty at the rate of 14s. per cwt. on foreign-grown coffee and 4s. 8d. per cwt. on British-grown has been paid. Some of the coffee comes in parchment on consignment; and before sale, it must be hulled and sorted in the milling establishments, most of which are in bonded warehouses on the banks of the Thames.

The auctions are held four times a week, usually on Tuesday, Wednesday, Thursday, and Friday. The sales are advertised in the market paper, the *Public Ledger*, and also by the auctioneers, who issue catalogs of their offerings. A few hours before the beginning of the sale, samples are laid out for inspection by prospective buyers, who may cup-test them if they desire. The actual selling is done by competitive cash bidding, the highest bidder becoming the owner, provided the limit is reached. If the limit placed upon the coffee by the importing merchants is not obtained, the coffee is withdrawn to allow selling brokers to submit the highest bid to the merchants, or to be dealt with by private treaty. Bidding is done by brokers both for home trade and for exporters.

Home trade takes about a tenth of the coffee, the remainder being sold for export. If the coffee is bought for re-export, it can be transferred to the shipping port, still in bond, and shipped out of the country without paying duty. During the World War, auctions were held about twice a week; but after the signing of the armistice in November, 1918, the London traders resumed the four times a week practice.

#### *Coffee Exchanges and Trading Methods*

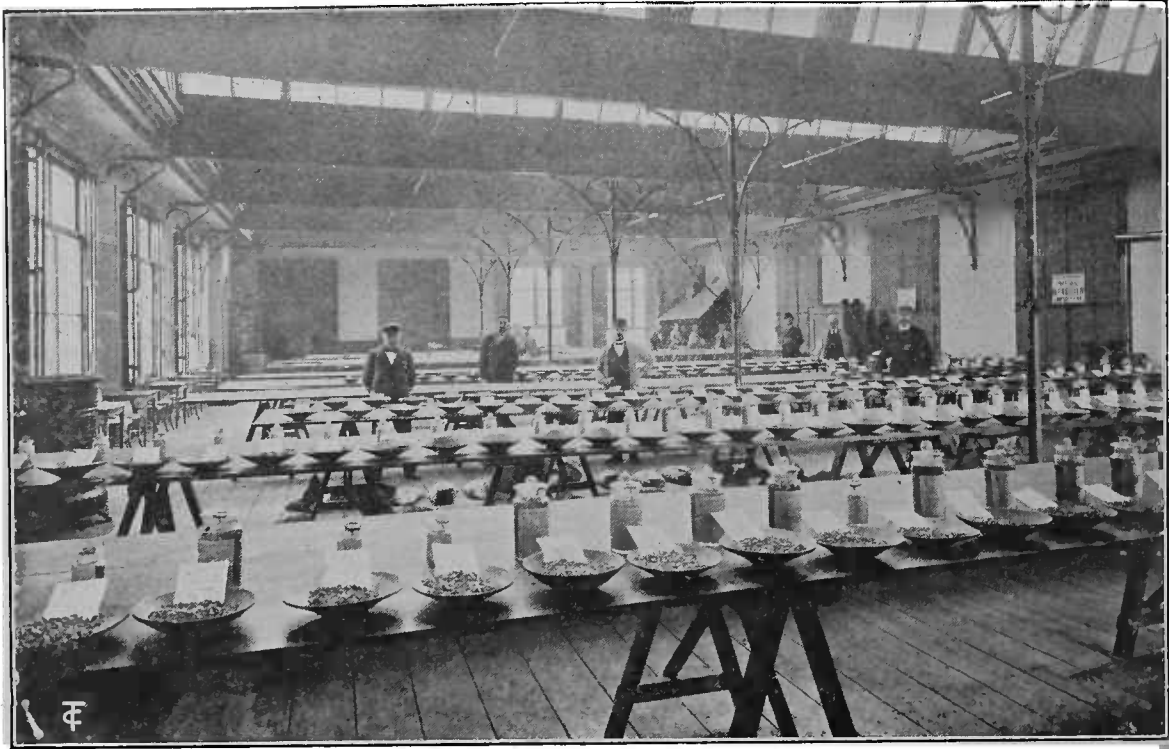
Green coffee buyers in the large importing centers of the United States and Europe recognize two distinct markets in their operations. One of these is called the "spot" market; because the importers, brokers, jobbers, and roasters trading there deal in actual coffee in warehouses in the consuming country. In New York the spot market is located on either side of Front

and Water Streets. Here coffee importers, coffee roasters, coffee dealers and coffee brokers conduct their "street" sales.

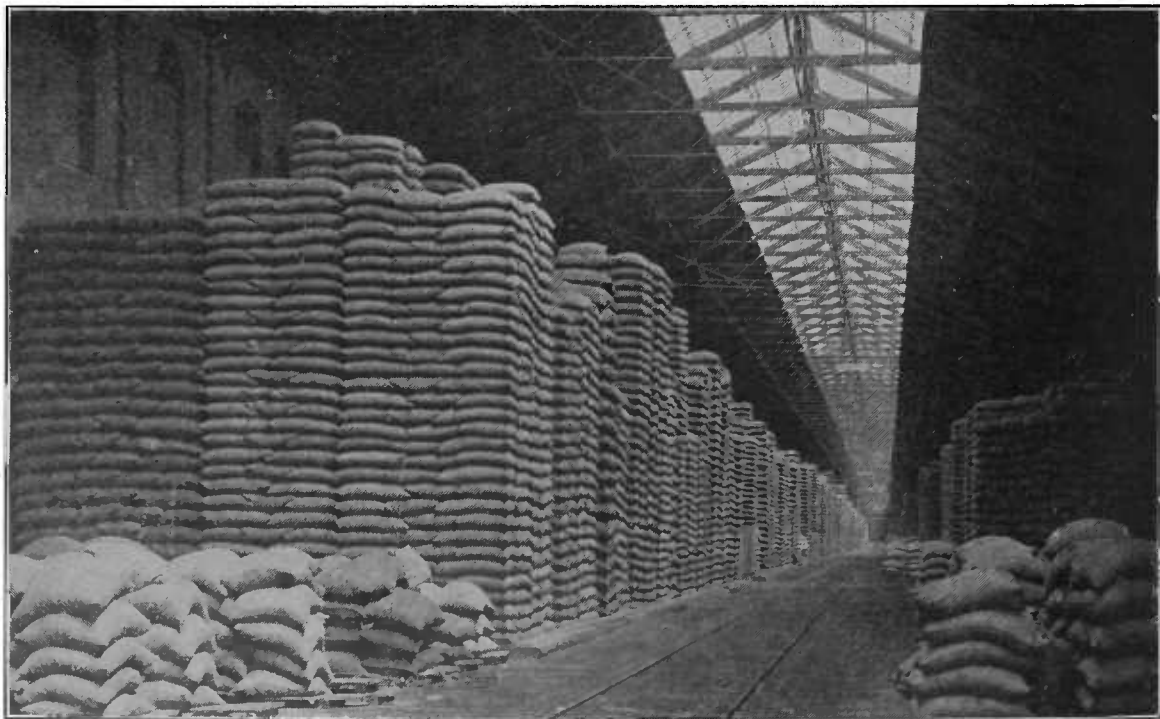
The other market is designated as the "futures" market, and the trading consists of the purchase and sale of contracts for the future delivery of coffee. Contracts are made for delivery as far ahead as thirteen months. Each contract specifies delivery, however, in one particular month with the seller having the option of deciding when, during that month, delivery will take place. Futures are dealt in only on recognized and organized coffee exchanges. The principle exchange is in New York but, in addition, there is an Exchange in Havre, and in Santos and Rio de Janeiro in Brazil. New Orleans and San Francisco, although having no futures markets, are large centers of coffee trade in "spot" coffees, and use the New York market for the future operations.

Future contracts on coffee exchanges vary slightly with the country where the Exchange operates. In New York the contracts are all similar and interchangeable, and delivery is made to the last holder of the contract. Therefore, they can be bought, sold, and exchanged many times and in the end bought back by the original seller or sold by the original buyer, in which case no delivery takes place. Generally, the operations are in the nature of a hedge against holdings of coffee, expected supplies—on the part of the producer—or purchases in advance by the roaster. Margins are made good daily throughout the life of the contract; money being deposited with the Clearing Association or demanded from the Association as the variations of the market warrant.

The New York Coffee and Sugar Exchange deals in all coffee grown in North, South, and Central America, the West Indies, and the East Indies (excluding Natural Robusta and coffees of new and unknown growths) under Contract "A" or the No. 7 contract. No. 7 official type of the Exchange is used as a basis for quotations, all other types are judged in relation to it. In addition, since 1928, a new contract "D" has been traded, calling for the delivery of coffee shipped only from the port of Santos, described as of "fair to good roast," and "soft," which is a description of the drinking and roasting qualities of the coffee. The quotations in this



COFFEE AUCTION SAMPLES ON DISPLAY AT AMSTERDAM



GREEN COFFEE STORED ON THE DOCKS AT HAVRE, FRANCE

HANDLING GREEN COFFEE AT TWO EUROPEAN PORTS

SCALE OF QUOTATION DIFFERENCES

<i>Brazilian Coffee—Not Santos Type</i>	<i>Santos Coffee Type</i>	<i>Other Kinds—Not Brazilian Type</i>
No. 1—180 points above	No. 1—260 points above	No. 1—300 points above
No. 2—150 points above	No. 2—230 points above	No. 2—250 points above
No. 3—120 points above	No. 3—200 points above	No. 3—200 points above
No. 4— 90 points above	No. 4—150 points above	No. 4—150 points above
No. 5— 60 points above	No. 5—100 points above	No. 5—100 points above
No. 6— 30 points above	No. 6— 50 points above	No. 6— 50 points above
No. 7—Basis	No. 7—Basis	No. 7—Basis
No. 8— 50 points below	No. 8— 50 points below	No. 8— 50 points below

A point is the hundredth part of a cent

contract are based on Santos No. 4 grade, and delivery of a grade poorer than No. 6 or an average grade on the delivery poorer than No. 5 is not permitted. Since 1930, a third contract, termed "H," providing for delivery of Colombian coffee only, has been added to the Exchange contracts. A separate type is used for comparing Colombian coffees. A contract "L," in which there has been no trading of consequence, is similar to the "A" contract and was aimed at replacing that contract. It differs from the "A" in that it provides for the same list of coffee as under the "A" with the addition that Brazilian coffees of "soft" drink, regardless of the shipping port, may be delivered at a premium over the basic differences.

Only the "A" contract, which has existed with little change since the start of trading in 1882, and the "D" or Santos Contract are actively traded. The volume in the Santos contract has expanded greatly since its inception and lately has been running ahead of the "A" contract in volume.

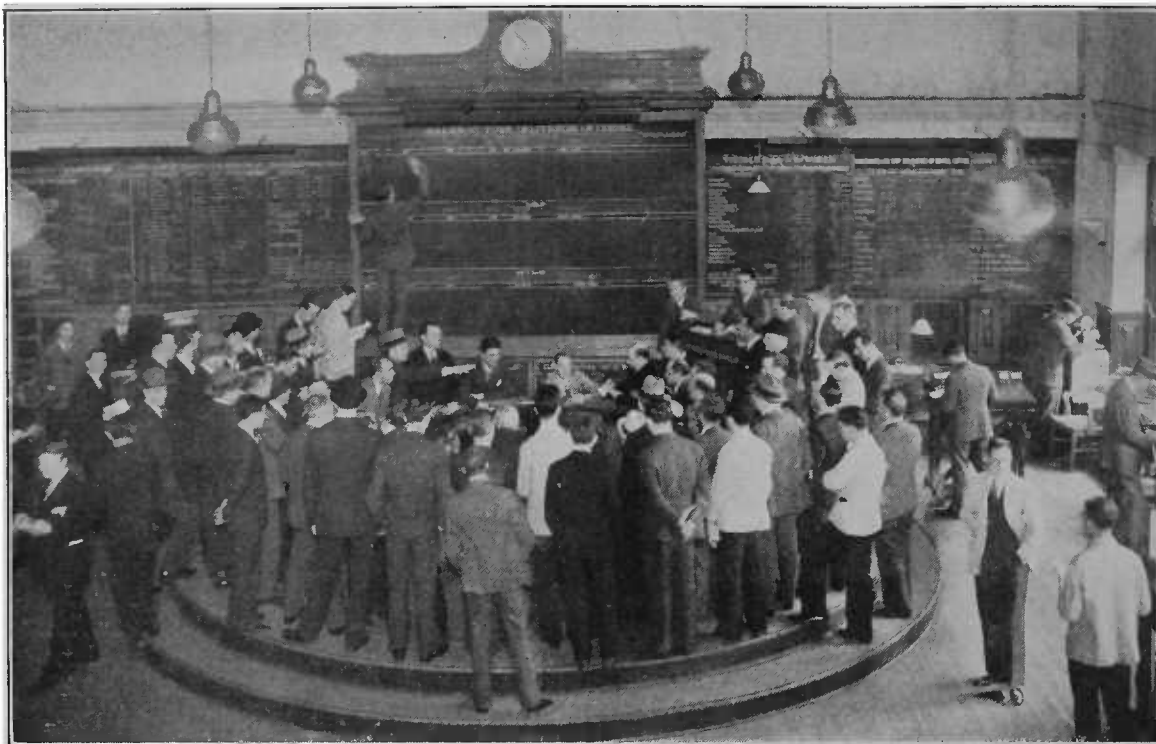
In determining the grade of a type of coffee submitted, a comparison with the Exchange type is made and the grade determined by the number of imperfections. Coffee is classified not only at a specific grade, such as No. 7, but in between grades. For instance a coffee grading not quite so good as No. 7 but not so poor as No. 8, might be graded 7 minus 20 or 8 plus 30, which would be the same thing if the difference between 7 and 8 was 50 points, in other words 20 points poorer than No. 7 in the first instance and 30 points better than No. 8 in the latter. A point in this instance means 1/100¢ per pound premium or discount, over or under the basic price.

There have been many lists of imperfections published with their relative values in grading. For instance one list describes

5 shells as equal to one black bean, a "black bean usually being the basis and equal to one defect." The list also rates, one large twig equal to 10 defects, one large stone equal to 10 defects, five green beans equal to one defect, etc., listing the equivalent of sour beans, sailors, small twigs, clods of earth, etc. The Exchange, however, issues no hard and fast table of imperfections or "defects" as they are called. The official exchange graders are therefore allowed to use their combined judgment as to relative values of various extraneous matter in addition to damaged or malformed beans in any given sample. The constant changes that would have to be made in an official

COFFEE GRADING TABLE

on 450 grs. weight			
<i>Type</i>	<i>Imperfections</i>	<i>Type</i>	<i>Imperfections</i>
2	6	5 plus 20	46
2 minus 07	7	5 plus 15	49
2 minus 14	8	5 plus 10	52
2 minus 21	9	5 plus 05	55
		5	58
3 plus 21	10	5 minus 05	63
3 plus 14	11	5 minus 10	68
3 plus 07	12	5 minus 15	73
3	13	5 minus 20	79
3 minus 03	14	5 minus 25	86
3 minus 06	15	6 plus 20	94
3 minus 09	16	6 plus 15	100
3 minus 12	17	6 plus 10	105
3 minus 15	18	6 plus 05	110
3 minus 18	19	6	115
3 minus 21	20	6 minus 05	120
3 minus 24	21	6 minus 10	128
		6 minus 15	138
4 plus 24	22	6 minus 20	150
4 plus 21	23	6 minus 25	163
4 plus 18	24	7 plus 20	178
4 plus 15	25	7 plus 15	190
4 plus 12	26	7 plus 10	202
4 plus 09	27	7 plus 05	215
4 plus 06	28	7	225
4 plus 03	29	7 minus 05	235
4	30	7 minus 10	260
4 minus 05	33	7 minus 15	285
4 minus 10	36	7 minus 20	310
4 minus 15	39	7 minus 25	335
4 minus 20	42	8 plus 20	360
4 minus 25	44	8 plus 15	385
		8 plus 10	410
		8 plus 05	435
		8	450



THE COFFEE-TRADING RING OF THE NEW YORK COFFEE AND SUGAR EXCHANGE

The Exchange room contains two "Rings" and quotation boards, one for sugar, and the other for coffee. Trading in coffee has continued since 1882.

list to keep pace with changing coffees from each year's crops and changing demands of the trade, are therefore eliminated. A Type No. 1 would be classified as a perfect coffee, while a Type No. 6 might contain over seventy-five defects. A No. 8 coffee might contain over 300 defects, and no coffees grading poorer than No. 8 are allowed to enter the country. The table on page 359 shows a scale of official fixed differences whereby the value of any particular grade, or any of the Exchange contracts may be determined. The growth of



OFFICIAL GRADERS OF THE NEW YORK COFFEE EXCHANGE AT WORK

the coffee and the contract under which it is to be delivered must be kept in mind for the differences vary with the contract and growth of coffee delivered. Let us assume the delivery of "Surinam coffee" under the "A" contract. The first column of Schedule No. 1 would be used. The basic grade of the "A" contract is No. 7 and our basic purchase price is say 6.10¢ per pound. Let us assume the Surinam coffee grades No. 3; by reference to the table we find that No. 3 grade (Surinam coffee) carries a premium or 120 points above the basis grade. Therefore if we were a buyer we would pay the basic price 6.10¢ plus 1.20¢ or 7.30¢ or, if a seller, would receive a like amount for our No. 3 grade (Surinam coffee) delivered under the "A" contract. In a like manner, if delivery is under the "D" or Santos contract, Schedule No. 3 would be used in calculating the premium or discount above or below the basis, which in the Santos contract is No. 4. In the "H" or Colombian contract the differences depend on the district, in which the coffees are grown, and the scale is used in that manner, but the coffee has to be up to the standard type in quality.

An important function of the Exchange is the grading of coffee. The rules provide

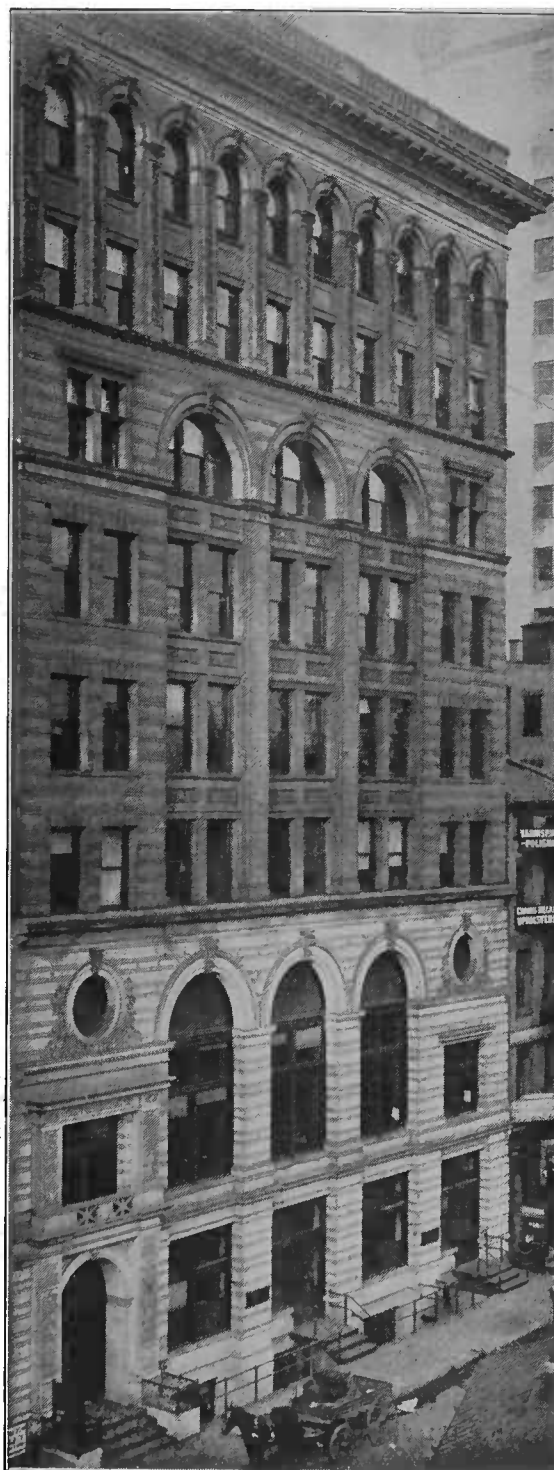


for seven standard grades, Nos. 2 to 8, and only licensed graders are permitted to pass upon the coffee handled on the Exchange. The grading and classification is conducted by the Exchange in quarters especially provided for the purpose. When an application for grading is received by the Superintendent, samples of each chop of coffee are drawn by a licensed sampler and delivered to the Exchange. A representative of the deliverer and receiver are then required to inspect the sample jointly and either to approve or disapprove of it as being a true sample of the chop. After signifying their approval, the names of three graders and classifiers are selected by lot and are notified to appear at the Grading Room at a specified time.

Their majority decision on each chop determines the grade and deliverability of the chop and is final unless appealed by either the deliverer or receiver. In the case of an appeal, the original sample is submitted to an additional group of five graders and classifiers, of whom none may have participated in rendering the original decision. These five graders proceed to consider the merits of the appeal, and the decision of the majority of these graders is final. In no case is the identity of any sample or the names of the interested parties disclosed to the graders, the only distinguishing mark being a serial number allotted to each sample by the Exchange.

When all questions of grade—and cup quality when necessary—have been decided, a Certificate of Grade, Quality, and Condition is issued by the Exchange, stating that the coffees named therein are deliverable under a certain contract. This certificate permits the holder to re-deliver the coffees without further grading for a period of one year (six months in the case of Colombian coffee delivered under the "H" contract).

Coffee may be "certificated" in advance of delivery to enable the owner to discover whether or not certain coffee is deliverable before definitely committing himself by issuing a Transferable Notice. The procedure is essentially the same as that heretofore outlined although, of course, there is no receiver. The decision of the three graders and classifiers must be unanimous to be binding. If it is not, the same sample is submitted to an additional five graders for their consideration. The decision rendered by a majority of them determines the



NEW YORK COFFEE AND SUGAR EXCHANGE

The building fronts on Hanover Square and extends through to Beaver Street. The exchange rooms are indicated by the arched windows on the second floor. The rest of the building is devoted to offices. The exchange was founded in 1881, and was the first national coffee trading organization in the world.

question of deliverability of the coffee. Where coffee graded in the latter fashion is declared deliverable, the Exchange issues a Certificate of Classification, which enables its possessor to obtain a Certificate of Grade, Quality, and Condition when the coffee is actually to be delivered. This certificate varies in no degree from that previously described, and is good for the same length of time.

Going back to the "spot" market, which was described as trading in coffees in warehouse in the consuming country, the trader may also buy or sell coffee "to arrive"; that is, a consignment on board ship on the way to the market. However, most of the business that is done in addition to a spot business is on what is called a "cost and freight" basis. In New York cables are received daily quoting the cost and freight offering price on various grades and types of coffee. Although the term "cost and freight" means that all charges including the freight are included in the offered price, the importer here actually pays the freight on the arrival of the coffee in New York and an equivalent amount is deducted from the draft in payment. Some trading is done on a consignment basis or bought in a shipping port and already the property of the importer. When shipped on a consignment basis, the coffee usually is sold on an "in-store" contract, and the buyer takes delivery at the warehouse. He usually is given a month's storage privilege before removal of the coffee. In addition to the aforementioned, coffees are also sold "c.i.f.," (cost, insurance, and freight) being included in the price or on an f.o.b. delivery steamer at loading port, basis. Most of the business, however, is done on a "cost and freight" basis. Payment usually is made by a letter of credit drawn on a New York or London bank, entitling the exporter to draw at ninety days' sight against the shipping documents, so that the shipment will be in the hands of the purchaser long before the draft is made. However, the exporter receives payment by discounting the bill in advance. Frequently, the jobber acts as his own importer of Brazil coffee, buying direct from the exporter without utilizing the agency of a broker or a regular importing firm. Brazil coffees usually are bought on the basis of New York Coffee and Sugar Exchange grades, with provision for a variation of the grade. A typical example might read,

"about Grade 3 (or whatever the offer stated), Brazilian classification based on New York Coffee and Sugar Exchange standards." The Green Coffee Association of New York is often called upon to arbitrate differences on coffees upon arrival, but usually the dispute revolves around the drinking quality of the coffee rather than the grade. The Brazilian seller, to uphold his reputation, tries to have the coffees shipped up to the grade specified in the c. & f. contract. Much coffee is sold on description given in good faith but not guaranteed, and disputes thereon are settled by the parties involved. Some is sold on guaranteed descriptions, to be settled by Green Coffee Association arbitration or in some other stated manner. As the quality of most of the coffee sold is a question of good faith on the part of the seller, it is obvious that those shipping inferior grades or qualities, or refusing adjustment in some mutually satisfactory manner, are soon eliminated by discriminating buyers.

In addition to the usual cost and freight contracts, Brazilian shippers have been selling coffees for shipment as much as twelve months ahead, that is, say twelve thousand bags for shipment, one thousand bags per month for twelve succeeding months. This should not be confused with the "futures" contract on the Exchange as it is entirely different, being a definite contract for a definite type of coffee between the buyer and seller. The adoption of the New York Coffee and Sugar Exchange standards of grade throughout the world and the adoption of uniform contracts has been a big step in the marketing of coffee, eliminating much confusion and dispute.

#### *How the N. Y. Exchange Functions*

When the New York Coffee Exchange opened on March 7, 1882, the coffee trade was in need of an organized market place, having just passed through one of the worst panics that has ever befallen the industry. The Exchange was incorporated June 2, 1885, as the "Coffee Exchange of the City of New York," which title was changed to the present one "New York Coffee and Sugar Exchange, Inc.," following the addition of sugar trading. The charter states its purpose as follows: "to provide, regulate, and maintain a suitable building, room or rooms for the purchase and sale of coffees and similar grocery ar-

ticles in the city of New York, and the stocks and securities of corporations producing, treating, or dealing in any of such articles, to adjust controversies between its members, to inculcate and establish just and equitable principles of trade, to establish and maintain uniformity in its rules, regulations and usages, to adopt standards of classification, to acquire, preserve and disseminate useful and valuable business information, and generally to promote the above mentioned trade in the city of New York, increase its amount, and augment the facilities with which it may be conducted."

In the promotion of trade at New York, the Exchange has been highly successful. From time to time the question has been raised as to its value to non-speculating members. As a large part of the business done on the Exchange is in the form of "hedging", the following excerpt from an opinion in the case of the "Board of Trade of City of Chicago v. Kinsey, 130 Fed. 507" is of interest. The court stated on page 512: "If we felt called upon by the necessities of this decision to give a definite opinion of hedging, the record might well lead us to find that hedging is a manufacturer's or merchant's insurance against price fluctuations of materials, and no more damnatory than insurance of property and life. . ."

As in the grain and cotton markets, dealers protect themselves against price fluctuations by hedging in the futures market. Importers, for instance, when purchasing coffee abroad, frequently sell an equal amount for future delivery on the Exchange. When the time for delivery arrives, it is simply a question of calculation of the market conditions whether it is more advantageous to repurchase the sales made as a hedge, or as a kind of insurance to protect themselves against loss, and free the coffee so engaged, or to make delivery of the coffee as it comes in.

A definition of a futures contract and something regarding the economic functions of a "futures" exchange follows:

#### *Futures Contract*

Charles O. Hardy in his book, *Risk and Risk Bearing*, thus defines the features of a futures contract which distinguish it from an everyday commercial contract: "A futures contract may be defined as a contract for the sale of a stipulated amount

of a specified grade of some commodity at a fixed price at a future date. Typically, it contains the following special features. *First*, the specific provisions of the contract are determined by the rules of the exchange, the actual bargain being made in a highly informal way. The rules and practices of the exchange are implied in each volume in the absence of a specification to the contrary. *Second*, the futures contract is a basis contract, which means that the commodity delivered under it may be either of the contract grade or of some other grade which may be delivered at the seller's option at a price above or below the contract price. The method of determining the differential varies in different exchanges. *Third*, the seller is given the option of making delivery at any date between specified limits within a specified calendar month. *Fourth*, the enforcement of the contract is assured by a provision that a specified amount known as a "margin" shall be deposited with some third party by each of the contracting parties. These deposits are intended to protect the seller against a refusal of the buyer to make good his contract in case of a fall in prices and, conversely, to protect the buyer against a default on the seller's part in case of a rise. *Fifth*, delivery is effected by delivery of warehouse receipt for the commodity, which must be stored in a specific place, usually in approved warehouse in the city in which the exchange is situated."

A hedge has been defined as "A sale or purchase of a contract for future delivery against a previous simultaneous or expected purchase or sale of an equal quantity of the same commodity, or an equivalent quantity of another commodity that has a parallel price movement, and where it is expected that the transaction in the contract market will be cancelled by an offset transaction at the time the contemplated spot transaction is completed, and before the futures contract matures." The hedge then entails the use of the futures contract on a commodity exchange as a means of offsetting the trade transaction.

#### *Economic Functions of the Exchange*

A description of the economic functions of the exchange is a sufficient indication of the advantages which producing and consuming groups obtain from its exist-

ence. The economic services of the futures exchange may be outlined as follows:

1. The Insurance Function.
  - (a) The Exchange provides a broad market.
  - (b) The Exchange provides a continuous market.
  - (c) The machinery of the Exchange provides a means of offsetting and protecting spot transactions by contre-purchases or sales of futures.
2. The Financing Function.
  - (a) A continuous market and the ready transferability of commodities by means of warehouse receipts give the commodity a high degree of liquidity.
  - (b) Liquidity of the commodity is an encouragement to larger loans by bankers and it is a safeguard to the banker.
  - (c) Ability to finance commodity readily enables dealers and manufacturers to operate successfully on smaller profit margins.
3. The Price Registration Function.
  - (a) Joining of markets by wire and cable focuses all private influences on the commodity exchange.
  - (b) All futures markets are thus linked together and made one broad market.
  - (c) The presence of a volume of speculation insures that every known influence bearing upon prices will be given weight.
  - (d) Interpretation of news by dealer, manufacturer and trader assures a degree of anticipation of future events that would not otherwise be possible.
4. The Informative Function.
  - (a) The Exchanges gather and make public statistics of supply, transportation and demand which are useful in estimating price changes.
  - (b) The daily record of prices informs all interested not only of present prices, but of the anticipated future trend.
  - (c) On the basis of future quotations, dealers and manufacturers are enabled to make their purchases and sales with a high degree of certainty.
5. The Regulatory Function.
  - (a) Exchanges regulate speculation and provide for its conduct along orderly lines.
  - (b) Exchanges' standards of inspection, weighing and grading contribute to certainty in the trade.

#### *Facts About the N. Y. Exchange*

The initiation fee was originally \$250, and is now \$50,000. The Exchange has still six memberships which may be issued at this figure. Of course, while the mar-

ket for memberships is below the \$50,000 level, a new member will buy his membership at the lowest offered price from some one who is already a member and is desirous of selling his membership. In this case, a transfer fee of \$1,000 is collected by the Exchange from the new member. Seats on the Exchange once sold as low as \$110. The high point, \$31,000, was reached in February, 1929, but in 1932 they sold as low as \$3,000. A membership is now (1935) worth about \$4,000.

The Exchange includes in its membership 312 brokers, importers, dealers, and roasters. To be eligible for membership a man must be twenty-one years old, either resident or non-resident, and of good character and commercial standing. He is proposed and seconded by Exchange members and passed upon by a committee on membership, which refers his application, with its recommendation, to the Board of Managers. The Board has the final vote on each prospective member; one adverse vote in three being sufficient to reject him.

The Exchange elects annually a president, vice-president, and treasurer, who perform the usual duties of Exchange officers. The governing body is the Board of Managers, consisting of the president, vice-president, treasurer, and twelve other members. This governing board, meeting monthly, appoints the necessary subordinate officers and employees, and fixes their compensation, and may "summon before them any officer or member for any purpose whatsoever." It appoints the secretary of the Exchange from among its own number, a superintendent of the Exchange, and the numerous committees which are in active charge of specified activities. It also licenses the necessary coffee graders, warehousemen, weighmasters, and samplers of the Exchange.

A brief discussion of the duties of the superintendent and the various committees will help to explain the methods of the Exchange's functioning. The superintendent, under the direction of the Board of Managers, has charge of the details of its work and of that of the various committees. He keeps all the books and documents of the Exchange; collects and pays over to the treasurer all moneys due the Exchange not otherwise provided for; has active charge of the Exchange rooms and the bulletin board; and manages and appoints, with the consent of the Board of Managers, the

assistants needed to perform the details of the work under his charge.

As claims and trade controversies occasionally arise, the Exchange has provided means for their peaceful settlement. The Board of Managers elects annually an arbitration committee of five members, who swear to decide disputes fairly. This is the only committee on the Exchange that has power to adjudicate disputes between members and non-members; and its services must be sought by the disputants, who must agree to abide by its decision. An adjudication committee of seven is chosen annually from the membership by the managers to adjust all claims and controversies between members arising out of any merchandise transaction, "if notice in writing of such claim or controversy, and of the intention to demand an adjudication thereon, be served by either party thereto within ten days from the ascertainment thereof."

Within three days of the serving of this notice, each disputant selects an Exchange member as his adjudicator, and these two name the third, who must be a member of the adjudication committee. Even this decision may be appealed to the Board of Managers which, if it finds the grounds of appeal good, as decided by majority vote, appoints an appeal committee of five, of whom three must be members of the Board. This last committee's decision is final. No

call and at the close of the Exchange, and fixes the price of the contract market, to be posted on the blackboard and transmitted to other exchanges and commercial bodies."

A committee of five on trade and statistics has the important function of reporting to the board as to regulations for the "purchase, sale, transportation and custody of merchandise," and it attempts to establish uniformity in such matters between different markets. It has charge also of all matters pertaining to the supply of newspapers, market reports, telegraphic and statistical information for the use of the Exchange. In the early '80s the Exchange abolished the old method of keeping coffee statistics, and the basis then adopted has since been accepted by all the large coffee markets of the world.

Other committees are the finance committee which audits bills and claims against the Exchange, directs deposits and investments, and audits the monthly and yearly accounts of the treasurer; a law committee which deals with matters of legislation; a membership committee; a floor committee; and a nominating committee. Organized as above outlined and with a well established code of trade rules, the Exchange annually transacts a large number of sales.

The minimum rates of commission on coffee "per contract of 250 bags, for members of the Exchange" as contrasted with non-members are as follows:

	<i>For customer residing in the U. S. and Canada</i>		<i>For customer residing outside the U. S. and Canada</i>	
	<i>Members</i>	<i>Non-members</i>	<i>Members</i>	<i>Non-members</i>
Based upon a price of:				
9.99 cents and below	\$ 6.25	\$12.50	\$ 8.75	\$15.00
10 cents to 19.99 cents inclusive	7.50	15.00	10.00	17.50
20 cents and above	10.00	20.00	12.50	22.50

new testimony bearing on the case may be introduced after the case has been closed by the adjudicators. Arbitration is voluntary with both parties; while adjudication is compulsory upon the application of either.

Another committee of trade importance is the spot quotation committee of five Exchange members. Each day at two o'clock, except on Saturdays when it meets at 11:45, this committee by a majority vote establishes the official daily market quotations of No. 7 coffee, Santos No. 4 coffee, and Colombian coffee. There is likewise a committee on quotations of futures. This committee meets daily "immediately after the

Many grades and growths of coffee are provided for in Exchange contracts. This has done much to lessen the probability of corners in coffee; and further protection is given by the stringent rule that the maximum fluctuations on the Exchange can be only 1 cent a pound on coffee in one day. If greater changes should threaten, the Exchange operations would automatically cease.

False or fictitious sales are prohibited, and all contracts must be reported to the superintendent. All contracts are binding and call for actual delivery.

The board of managers has power to close the Exchange or to suspend trading



on such days or parts of days as would in their judgment be for the Exchange's best interest.

The Clearing Association is a separate and distinct corporation, but is composed exclusively of Exchange members. Every member has to bring his contracts up to market closing every night, either by making a deposit with the Association to cover his balances or by withdrawing in case the market difference is in his favor. Members deposit \$15,000 at the time of joining as a guaranty fund.

The daily quotations on the coffee exchanges of New York, Havre, Rio de Janeiro, Santos, and—before the war—of Hamburg, determine to a large extent the price of green coffee the world over. The prices prevailing on the New York Coffee and Sugar Exchange are studied by coffee traders in all countries, the fluctuations being reflected in foreign markets as the reports come from the United States. Quotations are cabled from one great market to another; and as each must heed those of the others to some extent, the coffee trade thus obtains a world price, and the effect on supply and demand is universal rather than local.

Brazil coffee cable quotations are the market prices in Rio or Santos of ten kilograms of coffee, the price being stated in milreis, the monetary unit of Brazil. The basic grade of coffee at Rio is the No. 7 of the New York Coffee and Sugar Exchange. One kilogram (often written kilo, or abbreviated as K.) is equal to 2.204 pounds; and the ten kilogram standard of quantity is, accordingly, equivalent to 22.04 pounds, or just one-sixth of a standard Brazil bag.

The money value is not so simple, since Brazilian paper currency fluctuates; and the milreis quotation means nothing unless it is considered in connection with the rate of exchange for the same day; i.e., the current dollar value of the milreis. This dollar value is always given with the daily quotations from Brazil, and is expressed in milreis per dollar. The par value of the milreis (1,000 reis) is 11.96 cents (gold) of United States money; but its actual value as of 1935 is only about 8.5 cents. Our dollar sign is used to denote milreis, being placed after the whole number, and before the fractional part which is expressed in one-thousandths. Thus,  $8\frac{1}{4}$  milreis would be written 8\$250.

Suppose, for example, a Rio quotation is

given at 12\$500, with exchange at 11\$500 (milreis to the dollar). This means that 22 pounds of coffee have a value of \$1.09 ( $12\$500 \div 11\$500 = \$1.09$ ), making the coffee worth 5¢ per pound.

Persons familiar with Brazil quotations will not need to make this reduction to the dollar term in order to understand the figures. They will have a proper relative meaning to them in their original form; and it must not be overlooked that it is in this form only that they express correctly the value of the coffee in Brazil. It may make a great difference to the Brazilian planter or exporter whether an increased value of his coffee arises through a higher milreis bid or an appreciated exchange simply on account of local currency considerations. The purchasing power of a milreis in Brazil does not necessarily vary exactly as the rate of exchange.

In addition, during late years, various exchange restrictions have been decreed. Two rates, an official and an "open" rate, have been operative. Since the general world depression started, many countries have of necessity placed restrictions on foreign exchange. Brazil has been no exception. Although the par for the milreis is set at 11.96¢, Exchange operations have been at a rate fixed by the Bank of Brazil, called the official rate. For several years remission of funds from Brazil was prohibited and millions of dollars in milreis were locked up in Brazilian banks. Early in 1935 the Exchange policy called for the sale of 35 per cent of all export bills at the official rate, which is approximately 11.5 milreis to the dollar. The balance may be negotiated at the "open market rate" which is subject to wide fluctuations as supply and demand for milreis vary.

London quotations are made in shillings and pence, on one-hundredweight (cwt.) of coffee. This "cwt." is not the American 100 pounds, but the English 112 pounds, or one-twentieth of the English ton (our long ton) of 2,240 pounds. In all English coffee statistics the quantities are expressed in this ton. A London quotation of 30/9 (30 shillings and 9 pence), for example, is equivalent to \$7.44 for 112 pounds of coffee, or 6.64 cents per pound at the normal rate of exchange, about \$4.86 the pound sterling.

At Havre the coffee price is quoted in francs on a quantity of 50 kilograms. This is 110 pounds, and almost as much, there-

COFFEE DECIMAL TABLE

Showing differences of 1 point per lb. on one lot (250 bags) Coffee. Net weight 32,500 lbs.

Pts.	0	1	2	3	4	5	6	7	8	9	Pts.
00		3.25	6.50	9.75	13.00	16.25	19.50	22.75	26.00	29.25	00
10	32.50	35.75	39.00	42.25	45.50	48.75	52.00	55.25	58.50	61.75	10
20	65.00	68.25	71.50	74.75	78.00	81.25	84.50	87.75	91.00	94.25	20
30	97.50	100.75	104.00	107.25	110.50	113.75	117.00	120.25	123.50	126.75	30
40	130.00	133.25	136.50	139.75	143.00	146.25	149.50	152.75	156.00	159.25	40
50	162.50	165.75	169.00	172.25	175.50	178.75	182.00	185.25	188.50	191.75	50
60	195.00	198.25	201.50	204.75	208.00	211.25	214.50	217.75	221.00	224.25	60
70	227.50	230.75	234.00	237.25	240.50	243.75	247.00	250.25	253.50	256.75	70
80	260.00	263.25	266.50	269.75	273.00	276.25	279.50	282.75	286.00	289.25	80
90	292.50	295.75	299.00	302.25	305.50	308.75	312.00	315.25	318.50	321.75	90
100	325.00	328.25	331.50	334.75	338.00	341.25	344.50	347.75	351.00	354.25	100
110	357.50	360.75	364.00	367.25	370.50	373.75	377.00	380.25	383.50	386.75	110
120	390.00	393.25	396.50	399.75	403.00	406.25	409.50	412.75	416.00	419.25	120
130	422.50	425.75	429.00	432.25	435.50	438.75	442.00	445.25	448.50	451.75	130
140	455.00	458.25	461.50	464.75	468.00	471.25	474.50	477.75	481.00	484.25	140
150	487.50	490.75	494.00	497.25	500.50	503.75	507.00	510.25	513.50	516.75	150
160	520.00	523.25	526.50	529.75	533.00	536.25	539.50	542.75	546.00	549.25	160
170	552.50	555.75	559.00	562.25	565.50	568.75	572.00	575.25	578.50	581.75	170
180	585.00	588.25	591.50	594.75	598.00	601.25	604.50	607.75	611.00	614.25	180
190	617.50	620.75	624.00	627.25	630.50	633.75	637.00	640.25	643.50	646.75	190
200	650.00	653.25	656.50	659.75	663.00	666.25	669.50	672.75	676.00	679.25	200

fore, as the English cwt. Actually the franc is equal to 6.55 cents. A French quotation of 152 means \$10 for 110 pounds of coffee, or 9.09 cents per pound.

In the coffee trade there are three kinds of brokers—floor, spot, and cost and freight.

Floor brokers are those who buy and sell future contracts on the floor of the Exchange for a fixed consideration per lot of 250 bags. "The floor brokerage on each contract bought or sold by one member for another giving up his principal on the day of the transaction, is based upon a price of:

9.99 cents and below	.....	\$1.50
10 " to 19.99 cents incl.	.....	1.75
20 " and above	.....	2.00"

The floor brokers act for various members of the Exchange and at the close of the day hand in memorandums giving the names of the principals for whom they have bought or sold, which concludes their part in the transaction.

Spot brokers are those who deal in actual coffee, selling from jobber to jobber, or representing out-of-town houses; the seller paying a commission of about twenty cents a bag in small lots, and half of one per cent in large lots.

Cost and freight brokers represent Brazilian accounts, and generally receive a brokerage ranging from 1 to 2 per cent. On

out-of-town business, they usually split the commission with the out-of-town or "local" brokers. The out-of-town brokers sometimes, however, deal direct with the importer. All brokers except floor brokers are sometimes called "street brokers." Most of the large New York, New Orleans, and San Francisco brokerage houses also do a commission business, handling one or more Brazilian or other coffee-producing-country accounts.

The unit quantity for delivery under all "future" coffee contracts is 32,500 pounds, in about 250 bags, deliverable in licensed warehouses in the Port of New York. Quotations for all "future" contracts are in cents and hundredths of a cent per pound. The minimum fluctuation is known as a point and on one contract amounts to \$3.25. The coffee market opens for trading at 10.30 A. M. and closes at intervals of five minutes for the various contracts, between 2.35 P. M. and 2.50 P. M. For several years it has been customary to close the coffee futures market on Saturdays during the summer months.

*Important Rulings Affecting Coffee Trading*

The United States have no coffee law as they have a tea law—prescribing "purity, quality, and fitness for consumption"—but buyers and sellers of green coffees are



A SELECTION OF GREEN COFFEE BRANDS OR MARKS

required to observe certain well-defined Federal rules and regulations relating specifically to coffee. Up to the year 1906, when the Pure Food and Drugs Act became law, the green coffee trade was practically unhampered; and several irregularities developed, calling into existence Federal laws that were designed to protect the consumer against trade abuses, and at the same time to raise the standards of coffee trading.

Under these regulations it is illegal to import into this country a coffee that grades below a No. 8 Exchange type, which generally contains a large proportion of sour or damaged beans, known in the trade as "black jack," or damaged coffee, as found in "skimmings." "Black jack" is a term applied to coffee that has turned black during the process of curing, or in the hold of a ship during transportation; or it may be due to a blighting disease.

Another ruling is intended to prevent the sale of artificially "sweated" coffee, which has been submitted to a steaming process to give the beans an extra-brown appearance. Up to the time that the Pure Food and Drugs Act went into effect, artificial "sweating" was resorted to by some coffee firms; and out of that practice grew a suit<sup>1</sup> that resulted in a Federal court decision sustaining the Pure Food Act, and classifying the practice as adulteration and misbranding.

The Act also is intended to prevent the sale of coffees under trade names that do not properly belong to them. For example, only *arabica* coffees grown on the island of Java can properly be labeled and sold as Javas; coffees from Sumatra, Timor, etc., must be sold under their respective names. Food Inspection Decision No. 82, which limited the use of the term Java to coffee grown on the island of Java, was sustained in a service and regulatory announcement issued in January, 1916. Likewise the name Mocha may be used only for coffees of Arabia. Before the Pure-Food Law was enacted, it was frequently the custom to mix Bourbon Santos with Mocha and to sell the blend as Mocha. Also, Abyssinian coffees were generally known in the trade as Longberry Mocha, or just straight Mocha; and Sumatra growths were practically always sold as Javas. Traders used

<sup>1</sup> *Tea and Coffee Trade Jour.*, 1911 (Vol. XX: No. 4: p. 284).

the names of Mocha and Java because of the high value placed upon these coffees by consumers, who, before Brazil dominated the market, had practically no other names for coffee.

One of the most celebrated coffee cases under the Pure Food Act was tried in Chicago, February, 1912. The question was, whether in view of long-standing trade custom, it was still proper to call an Abyssinian coffee (Longberry Mocha) Mocha. The defendant was charged with misbranding, because he sold as Java and Mocha a coffee containing Abyssinian coffee. The court decided that the product should be called Abyssinian Mocha;<sup>2</sup> but since then, general acceptance has obtained of the Government's viewpoint as expressed in F.I.D. No. 91, which was that only coffee grown in the province of Yemen in Arabia could properly be known as Mocha coffee.

Another important ruling, concerning coffee buyers and sellers, prohibits the importation of green coffees coated with lead chromate, Prussian blue, and other substances, to give the beans a more sylish appearance than they have normally. Such "polished" coffees find great favor in European markets, but are denied admittance here.

The Board of Food and Drug Inspection decided in 1910 against a trade custom that had prevailed until then of calling Minas coffee "Santos" when shipped through Santos instead of Rio.<sup>3</sup>

For years a practice obtained of rebagging certain Central American growths in New York. In this way Bucaramangas frequently were transformed into Bogotas, Rios became Santos, Bahias and Victorias were sold as Rios, and the misbranding of peaberry was quite common. A celebrated case grew out of an attempt by a New York coffee importer and broker to continue one of these practices after the Pure Food Act made it a criminal offense. The defendants, who were found guilty of conspiracy, and who were fined three thousand dollars each, mixed, re-packed, and sold under the name "P.A.L. Bogota," a well-known Colombian mark, eighty-four bags of washed Caracas coffee.<sup>4</sup>

<sup>2</sup> *Tea and Coffee Trade Jour.*, July, 1911 (Vol. XXIII: No. 1: p. 28).

<sup>3</sup> *Tea and Coffee Trade Jour.*, Nov., 1910 (Vol. XIX: No. 5: p. 380).

<sup>4</sup> *Tea and Coffee Trade Jour.* Nov., 1914 (Vol. XXV: No. 5: p. 397).

After an exchange of views with the United States Board of Food and Drug Inspection, the New York Coffee Exchange decided that, after June 1, 1912, it would abolish all grades of coffee under the Exchange type No. 8.

The practice in Holland of grading Santos coffees by selecting beans most like Java beans, and polishing and coloring them to add verisimilitude—known as “manipulated Java”—became such a nuisance in 1912 that United States consuls refused to certify invoices to the United States unless accompanied by a declaration that the produce was “pure Java, neither mixed with other kinds nor counterfeited.”

The United States Bureau of Chemistry ruled in February, 1921, that *Coffea robusta* could not be sold as Java coffee, or under any form of labeling which tended either directly or indirectly to create the impression that it was *Coffea arabica*, so long and favorably known as Java coffee. This was in line with the Department of Agriculture's previous definition that coffee was the seed of the *Coffea arabica* or *Coffea liberica*, and that Java coffee was *Coffea arabica* from Java. *Coffea robusta* was barred from deliveries on the New York Coffee Exchange in 1912, but since 1925 the rules have permitted the delivery of washed Robusta, grading below No. 7, on contract “A.”

During the greater part of the year 1918, the United States Government assumed virtually full control of coffee trading. It was a war-time measure, and was intended to prevent speculation in coffee contracts and freight rates, to cut down the number of vessels carrying coffee to this country so as to provide more ships for transporting food and soldiers to Europe, and to put the coffee merchants on rations during the stress of war. On February 4, 1918, importers and dealers were placed under license; and two days later, rules were issued through the Food Administration fixing the maximum price for coffee for the spot month in the “futures” markets at eight and a half cents, prohibiting dealers from taking more than normal pre-war profits, or holding supplies in excess of ninety days' requirements, and greatly limiting re-sales. On May 8, the United States Shipping Board fixed the “official” freight rate from Rio de Janeiro to New York at one dollar and fifty cents per bag, which, without control, had risen to as high as four dollars and more, as compared with the ordinary rate of thirty-five cents before the war. On January 12, 1919, two months after the armistice was signed, the rules were withdrawn, and the coffee trade was left to carry on its business under its own direction, the same as before the control was established.





## CHAPTER XXVII

### WHOLESALE MERCHANDISING OF COFFEE

HOW COFFEES ARE SOLD AT WHOLESALE—THE WHOLESALE SALESMAN'S PLACE IN MERCHANDISING—SOME COFFEE COSTS ANALYZED—HANDY COFFEE-SELLING CHART—TERMS AND CREDITS—ABOUT PACKAGE COFFEES—VARIOUS TYPES OF COFFEE CONTAINERS—VACUUM PACKING—COFFEE-PACKAGE LABELS—COFFEE-PACKAGE ECONOMIES—PRACTICAL GROCER HELPS—COFFEE SAMPLING—PREMIUM METHOD OF SALES PROMOTION—CHAIN STORES AND THE WHOLESALERS

**C**OFFEE is sold at wholesale in the United States by about 5,800 firms, including wholesale grocers and concerns specializing in coffee. Of these, 1,100 firms roast their own coffee and the remainder have it roasted for them. A number of these roasters also sell green coffee to retail distributors who do their own roasting.

Much the largest proportion of the roasted coffee sold by wholesalers today is put up in ready-weighed, trade-marked packages, either ground or unground. A lesser proportion goes to retailers in regulation 132-pound bags, roasted and unground, with a supply of 1-pound paper bags imprinted with the retailers' brand, in which the retailer delivers the coffee to the consumer freshly ground. Only a small amount of roasted coffee is now sold in the old-style open bulk, and of the coffee sold in trade-marked packages in 1934 in the United States about 75 per cent was ground ready for brewing.

The wholesale houses generally confine their operations to the section of the country in which they are located, covering one or more states, but some of the biggest coffee-packing firms have national distribution. In both cases, branch houses are usually established at strategic points to facilitate the serving of retail customers with freshly roasted coffee at all times.

#### *The Wholesale Salesman*

The traveling salesman is probably the most effective agency in securing the re-

tailer's orders for coffee. A good coffee salesman not only sells coffee, but he teaches his customer how he can build up and hold his coffee trade. He acquaints the retailer with all the talking points about the coffee he handles, how to feature it in store displays and advertisements, how to stage demonstrations and to work up special sales.

If he is a *good* salesman, he does not permit the merchant to buy more coffee than he can dispose of while it is still fresh; and he shows the dealer the folly of handling too many brands of package coffees. If he sells coffee in bulk, the efficient salesman has also a sound working knowledge of blending principles, and is able to suggest the kinds of coffee to blend to suit the particular requirements of each grocer's trade. In short, he takes an intelligent interest in his customer's business, and cooperates with him in building up a local coffee trade.

#### *Profit Sharing for Salesmen*

A commission on net profits was recommended as the best basis for paying salesmen in a report made by the Bureau of Business Research of New York University in 1922, which analyzed the results of a comprehensive questionnaire sent out to 300 members of the National Coffee Roasters' Association at the request of the latter organization. The analysis showed lack of uniformity in the methods of paying salesmen by members of the NCRA throughout the country, and showed also that, while many schemes have been worked out to fit

widely differing conditions, commission on net profits appeared to be the best method that could be recommended, with the addition of special bonuses and prizes, and charging the salesmen with 50 per cent of the loss on their accounts.<sup>1</sup>

The different methods of paying salesmen reported were as follows: straight salary, straight commission, drawing account and commission, and mixed methods. Some 23 per cent paid a drawing account and commission; 4 per cent paid straight commission; and 54 per cent had no uniform system, but paid both salary and commission.

Of those paying commission, 56 per cent paid on the basis of sales; 16 per cent, on gross profits less deductions; 16 per cent, on net profits; and 12 per cent on gross profits. Among those who paid commission based on sales, a majority figured on net sales; but a few paid on gross sales, at a lower rate than those who paid on net sales. Forty-six per cent of those who replied paid some form of bonus, gave prizes or had a profit-sharing plan, while 56 per cent paid no form of bonus.

In reply to the question, "What is your opinion as to whether the cost of selling coffee is more or less than the cost of selling other lines?" a majority of the wholesale grocers replied that they considered their selling expense for coffee greater than for the average run of groceries; but a majority of the coffee, tea, and spice dealers agreed that it costs less to sell coffee than either tea or spices.

#### *Some Coffee Costs Analyzed*

In estimating the price at which he must sell his coffee to make a fair profit, the wholesale coffee merchant has many items of expense to consider. To the cost of the green coffee he must add: the cost of transportation to his plant; the loss in shrinkage in roasting, which averages about 16 per cent; packaging costs, if he is a packer; the items of expense of doing business, such as wages and salaries, advertising, buying and selling, freight, express, warehouse and cartage, postage and office supplies, telephone and telegraph, credit and collection; and the fixed overhead charges for interest, heat, light, power, insurance, taxes, repairs, equip-

<sup>1</sup> *Tea and Coffee Trade Journal*, September, 1922 (p. 357).

ment, depreciation, losses from bad debts, and miscellaneous items. The average loss for bad debts among grocers in 1923, the last year for which figures are available, was 0.4 per cent of the total sales, according to the Harvard University Graduate School of Business Administration. Among 545 stores in small and large cities in 1924 the same authority found the total cost of doing business averaged 18 per cent of sales; that the net profit averaged 1.8 per cent of sales; and the stock was turned over about 10 times a year. Gross profits were 19.8 per cent, and total payroll 10.9 per cent of sales.

#### *Terms and Credits*

Wholesale coffee trade contract terms and credits are not dissimilar to those in other lines of commerce. For some years past there has been a wide-spread and growing tendency among wholesalers to finance retailers only to the extent of granting them 30 days in which to pay their bills net, with 1 per cent cash discount if the bills are paid within 10 days of the date of invoice. A discount of 2 per cent in 10 days, net in 30, however, is common in the jobbing trade.

The worst former abuses of credit and discount terms have been eliminated to some extent through closer cooperation between roasters. Terms and discounts were frequently abused, the customer demanding much longer credits and often taking a 10-day cash discount after 30 or more days had elapsed. This abuse was particularly prevalent from 1907 to 1913, when coffee prices were low and competition was especially keen.<sup>2</sup> In addition, the retailers often demanded special deliveries of supplies, which added to the wholesalers' costs; and some retailers refused to pay the cost of cartage from the cars to their stores.

Another trade abuse which has been corrected almost altogether was the practice of "selling coffee to be billed as shipped"; that is, the wholesaler held coffee on order, and billed it only as delivered, even though several weeks or months intervened before shipment.

#### *About Package Coffees*

Since the beginning of the twentieth century, the sale of coffee in packages has

<sup>2</sup> Gillies, E. J., *Tea and Coffee Trade Journal*, December, 1913 (pp. 574-76).

COFFEE-SELLING CHART

By A. J. DANNEMILLER

Showing Prices to Be Obtained to Realize Certain Per Cents on Sales of Roasted Coffee

Cost Roasted & Packed	10%	11%	12%	13%	14%	15%	16%	17%	18%	19%	20%	21%	22%	23%	24%	25%
4	4.44	4.50	4.55	4.61	4.67	4.72	4.77	4.82	4.88	4.94	5.00	5.07	5.13	5.20	5.26	5.33
4½	5.00	5.06	5.12	5.18	5.24	5.30	5.36	5.43	5.49	5.57	5.63	5.70	5.77	5.84	5.91	6.00
5	5.55	5.62	5.68	5.75	5.82	5.89	5.96	6.03	6.10	6.18	6.25	6.33	6.42	6.50	6.55	6.68
5½	6.11	6.18	6.25	6.33	6.41	6.49	6.57	6.65	6.72	6.80	6.88	6.97	7.06	7.15	7.24	7.33
6	6.67	6.74	6.81	6.89	6.97	7.06	7.15	7.24	7.33	7.42	7.50	7.60	7.70	7.80	7.90	8.00
6½	7.23	7.31	7.38	7.47	7.55	7.64	7.74	7.84	7.94	8.03	8.13	8.24	8.33	8.45	8.56	8.67
7	7.78	7.87	7.95	8.05	8.15	8.25	8.35	8.45	8.54	8.65	8.75	8.86	8.96	9.09	9.21	9.33
7½	8.34	8.43	8.52	8.62	8.72	8.83	8.93	9.04	9.15	9.26	9.30	9.50	9.63	9.75	9.87	10.00
8	8.89	8.99	9.09	9.20	9.31	9.42	9.53	9.65	9.76	9.88	10.00	10.13	10.26	10.39	10.53	10.67
8½	9.45	9.55	9.66	9.77	9.87	9.99	10.12	10.25	10.37	10.40	10.63	10.76	10.90	11.04	11.19	11.33
9	10.00	10.12	10.23	10.35	10.47	10.59	10.72	10.85	10.98	11.12	11.25	11.40	11.54	11.70	11.85	12.00
9½	10.56	10.68	10.80	10.92	11.04	11.17	11.31	11.45	11.59	11.73	11.88	12.03	12.18	12.34	12.51	12.67
10	11.11	11.24	11.37	11.49	11.63	11.77	11.90	12.05	12.20	12.34	12.50	12.66	12.82	12.98	13.16	13.33
10½	11.66	11.81	11.93	12.07	12.21	12.36	12.49	12.65	12.81	12.95	13.12	13.29	13.46	13.63	13.81	14.00
11	12.22	12.37	12.50	12.64	12.85	12.95	13.08	13.26	13.43	13.57	13.75	13.93	14.10	14.28	14.47	14.67
11½	12.77	12.93	13.07	13.21	13.37	13.54	13.68	13.86	14.03	14.19	14.38	14.56	14.74	14.93	15.13	15.33
12	13.33	13.49	13.64	13.79	13.95	14.12	14.28	14.46	14.65	14.81	15.00	15.19	15.38	15.58	15.79	16.00
12½	13.89	14.05	14.21	14.37	14.53	14.71	14.88	15.06	15.24	15.43	15.63	15.83	16.02	16.23	16.45	16.67
13	14.44	14.62	14.78	14.93	15.11	15.30	15.47	15.66	15.85	16.05	16.25	16.45	16.67	16.87	17.10	17.33
13½	15.00	15.18	15.33	15.51	15.69	15.88	16.07	16.27	16.46	16.67	16.88	17.08	17.31	17.53	17.76	18.00
14	15.55	15.73	15.90	16.08	16.28	16.48	16.67	16.84	17.07	17.28	17.50	17.72	17.95	18.17	18.40	18.67
14½	16.11	16.29	16.48	16.65	16.86	17.05	17.26	17.47	17.68	17.90	18.13	18.35	18.59	18.83	19.07	19.33
15	16.66	16.85	17.05	17.23	17.44	17.65	17.85	18.07	18.29	18.51	18.75	18.98	19.23	19.48	19.74	20.00
15½	17.23	17.43	17.61	17.80	18.03	18.22	18.45	18.67	18.90	19.13	19.38	19.61	19.87	20.12	20.39	20.67
16	17.78	17.98	18.18	18.38	18.60	18.83	19.05	19.28	19.51	19.75	20.00	20.25	20.51	20.77	21.05	21.33
16½	18.33	18.54	18.75	18.97	19.18	19.41	19.64	19.88	20.12	20.38	20.63	20.88	21.16	21.42	21.70	22.00
17	18.89	19.10	19.33	19.52	19.76	20.01	20.24	20.48	20.73	21.00	21.25	21.51	21.78	22.07	22.36	22.67
17½	19.44	19.66	19.89	20.10	20.35	20.59	20.83	21.08	21.34	21.60	22.88	22.15	22.43	22.72	23.03	23.33
18	20.00	20.22	20.45	20.67	20.93	21.18	21.43	21.69	21.95	22.22	22.50	22.78	23.05	23.37	23.68	24.00
18½	20.55	20.79	21.02	21.24	21.51	21.77	22.02	22.29	22.56	22.84	23.13	23.42	23.70	24.02	24.34	24.67
19	21.11	21.35	21.59	21.84	22.09	22.36	22.62	22.90	23.17	23.45	23.75	24.05	24.34	24.67	25.00	25.33
19½	21.66	21.91	22.16	22.41	22.68	22.95	23.21	23.50	23.78	24.07	24.38	24.68	24.99	25.32	25.66	26.00
20	22.22	22.47	22.73	22.99	23.25	23.54	23.81	24.11	24.39	24.68	25.00	25.31	25.64	25.97	26.32	26.67
20½	22.77	23.03	23.30	23.55	23.83	24.14	24.40	24.70	25.00	25.30	25.63	25.94	26.28	26.61	26.97	27.33
21	23.33	23.60	23.87	24.14	24.42	24.70	25.00	25.30	25.62	25.92	26.25	26.58	26.92	27.26	27.63	28.00
21½	23.88	24.16	24.43	24.71	25.00	25.29	25.59	25.90	26.22	26.54	26.88	27.22	27.56	27.91	28.28	28.67
22	24.44	24.72	25.00	25.28	25.58	25.92	26.19	26.51	26.83	27.16	27.50	27.86	28.10	28.56	28.94	29.33
22½	24.99	25.29	25.57	25.85	26.16	26.47	26.78	27.12	27.44	27.78	28.13	28.48	28.85	29.22	29.61	30.00
23	25.55	25.85	26.14	26.42	26.74	27.06	27.38	27.71	28.06	28.38	28.75	29.11	29.48	29.86	30.26	30.67
23½	26.11	26.41	26.70	27.00	27.32	27.66	27.97	28.32	28.66	29.00	29.38	29.76	30.12	30.51	30.92	31.33
24	26.67	26.97	27.26	27.58	27.90	28.24	28.57	28.92	29.27	29.62	30.00	30.38	30.77	31.17	31.58	32.00
24½	27.22	27.54	27.84	28.15	28.49	28.83	29.16	29.52	29.88	30.24	30.63	31.02	31.41	31.81	32.24	32.67
25	27.78	28.09	28.41	28.73	29.07	29.41	29.76	30.12	30.49	30.86	31.25	31.65	32.05	32.47	32.90	33.33

NOTE, FOR EXAMPLE: Coffee costing 13.50 per 100 pounds (see first column), to realize 17% on sales, must bring 16.27; which really represents 21% on cost.

increased steadily until now (1935) few retail grocery stores sell bulk coffee. Even chain-store concerns that roast for themselves deliver the coffee to their stores in branded paper bags or other form of container.

The trade has found that not only the composition of the blend but the degree of freshness of the coffee as received by the consumer are of equal importance for success. "Freshness," according to the interpretation given the word by coffee-men, relates exclusively to the amount of flavor which comes from the volatile, aromatic part of the coffee. By "stale" they mean a disagreeable flavor and odor which comes from exposure of the coffee to the oxygen of the air.

There has never been a universally accepted yardstick for measuring the degree

of freshness or the degree of staleness of ground coffee, but Dr. Walter H. Eddy, of Columbia University, developed the first method for using such a yardstick, as described in an article in the *Tea and Coffee Trade Journal* in 1932.<sup>3</sup>

Another important factor that contributes to package-coffee success is the container. It must be of such a character as will best preserve the flavor and aroma of the coffee until it reaches the consumer.

Package coffee has won well-nigh universal favor, as it is estimated that more than 90 per cent of the coffee now sold to retailers in the United States is in branded packages.

Some of the arguments advanced against package coffees are: that the price is gen-

<sup>3</sup> *Tea and Coffee Trade Journal*, November, 1932 (pp. 432-34).

erally higher than the same grade in bulk; that it leads to price-cutting by stores that can afford to sell it at about cost as a leader for other articles; that the margin of profit is frequently too close for some retailers; that when the market advances, some packers change their blends to keep down cost and to maintain the advertised price; and that, when packed ground, there is a rapid loss of flavor, aroma, and strength.

Friends of package coffees point to the saving in time in handling in the store; to the fact that the contents of a package are not contaminated by odors or dirt; that the blends are prepared by experts and are always uniform; that the coffee is always properly roasted; and, in the case of package ground coffee, properly ground; that the brand names are widely and consistently advertised; and that the retailer has the benefit of the packer's cooperation in building up sales campaigns, by means of booklets and local advertising.

#### *Various Types of Containers*

Changed selling methods of both independent retailers and chains, and new buying habits of consumers, have stimulated the creation of packages which help the sale of the goods they contain, and packers are responding with careful attention to the modernization of their old packages and the creation of new ones.

Eight types of containers are used for packing coffee; namely, paper bags, cardboard cartons, fibre or paper cans with tin ends, fibre cans with slip covers, vacuumized glass jars, glass jars not vacuumized, vacuumized tin cans, and tin cans not vacuumized.

**PAPER BAGS.** It has been stated that the three most important elements in successful packaging are economy, appearance, and protection, and while no one type of coffee container is supreme under all conditions, the paper bag embodies two of these essentials to an exceptional degree; its economy and attractiveness are generally recognized. Also, when lined with glassine, foil, or prepared paper it gives a fair amount of protection as well. Paper bags have the further advantages that the label and design can be imprinted directly on the bag and they lend themselves to close packing in shipping cartons.

The artistic possibilities of the paper bag as a container for coffee were amply

demonstrated when the A. & P. "Red Circle" bag carried off first honors at the 1934 annual Packaging Exposition of the American Management Association in New York. It was awarded the Irwin D. Wolf prize as "the best package developed and placed on the market during the year 1933."

**PAPER CARTONS,** or light cardboard boxes, as containers for coffee, are not much used in the United States, having been supplanted, to a large extent, by tin containers. There continues to be some demand for them, however, and an important advantage is that they take up a minimum of storage space, and like the paper bag can have their label and design imprinted directly. Another economy feature is their adaptability to the automatic packaging machine, which transforms them from flat sheets into wrapped and sealed packages of coffee. Moisture-proof and flavor-retaining inner liners and outside wrappers are quite generally used to prevent damage from outside or too rapid loss of coffee freshness from within.

There has been no radical change in the type of automatic machinery or the construction of the carton used in the packaging of coffees in cartons in the past fifteen years. In general, the equipment consists of an automatic carton feeder, bottom sealer, liner, weighing machines, liner interleaving device, top sealer, and wrapping machine. The entire filling and closing operation is accomplished automatically, without the aid of an operator at the rate of 30 to 60 complete packages per minute.

In a test of color preference for coffee cartons conducted by the Department of Advertising, Marketing, and Psychology at New York University, the results were as shown in the accompanying table; first

COLOR PREFERENCE FOR COFFEE CARTONS

Colors	Men (50)	Women (23)	Both (73)
Orange .....	1	1	1
Yellow .....	2	2	2
Red .....	3	3	3
Purple .....	4	6.5	4
Green .....	5	4.5	5
Blue .....	6	6.5	6
White .....	7	4.5	7
Black .....	8	8	8
Agreement between Men and Women			85%

choice being numbered "1," second choice "2," etc. It was observed that both the men and the women taking part in the test ranked orange, yellow, and red as first,



VARIOUS TYPES OF COFFEE CONTAINERS

This group illustrates some distinctive styles of coffee packages used in the United States. The types shown are as follows: *Top row, left to right*—vacuum tin can; lithographed tin with screw top; fibre sides, tin top and bottom, slip cover, paper label; all tin, slip cover, paper label. *Bottom row, left to right*—vacuum glass jar; folding cardboard carton; Duplex paper bag; paper bag, Cellophane wrapped.

second, and third, respectively, which formed the basis for the conclusion reached at the close of the investigation that the colors orange, yellow, and red have more psychological appeal on a coffee carton than any other colors. This color preference chart will be of interest because of its possible application to other containers as well as cartons.

**FIBRE OR PAPER CANS** are made of fibre board with tin tops and bottoms, which supply a measure of rigidity to the package, or else with tin slip covers. These composite packages usually are made either cylindrical or square in shape.

**GLASS JARS.** Among the various containers used in the merchandising of coffee the glass jar has received considerable attention—largely from its handsome appearance and re-use possibilities in the home of the consumer. Packers in various parts of the country have featured transparent, non-vacuumized glass containers for their coffee since about 1924, when a Middle West roaster originated the idea. A 1-pound jar was used, with a standard Mason jar cap and rubber. Later, the

same concern put out a 3-pound jar and a 3-gallon glass container, holding 10 pounds of coffee. All three were successful sales stimulators in the farming country in which they were sold, owing, no doubt, to the many possible re-uses of the containers.

**VACUUMIZED GLASS JARS.** Many coffee roasters were interested in glass containers for vacuum-packed coffee even before special closing equipment had been devised which was designed to overcome the tendency of ground coffee to fly out of the jar when the vacuum was applied. The escaping grains of coffee tended to get under the sealing gasket, thereby interfering with an efficient seal. Also, the only sealing equipment available was for jars of a type that would not allow an efficient re-seal, and could not be adopted for home canning and general household purposes. The machine subsequently developed to do the work puts on a screw closure, suitable for re-use at home. A number of well-known roasters in various parts of the country have placed vacuum-packed coffee in glass on the market. "Monarch"





### STEPS IN THE DEVELOPMENT OF PAPER BAGS FOR COFFEE

Left to right, first row—Ordinary grocer's bag; self-opening Kraft grocer's bag; extra heavy weight grocer's bag; glassine-lined with printing; lizard embossing and two-color printing. Second row—Lizard embossing and two-color printing; Kraft Duplex printed on four sides; Duplex bag utilizing super calendered bond; one-pound bag made from colored fibre. Third row—Duplex bag with foil liner; all-over printed stock design; four colors on four sides; Triplex (1½ pounds), white outside, Kraft middle, and glassine liner; cellulose Duplex bag. Fourth row—Duplex bag covered with moisture-proof transparent cellulose; white Kraft for added strength and superior printing qualities; Duplex with special "tin tie" closing device; half-pound Duplex bag.

vacuum-packed coffee in glass, put out by Reid, Murdoch & Co., Chicago, won the gold medal, emblematic of first place in the closure group at the 1935 All-American Package Competition, conducted by *Modern Packaging*, in New York.

UNVACUUMIZED TIN CANS have long held an honored place in the coffee trade of the United States as containers of advertised brands of coffee which frequently require transportation over long distances and through various hands before reaching the consumer. Here the emptied can frequently finds further use as a kitchen receptacle for other food products, such as rice, sugar, etc., which require a moisture and grease-proof container.

VACUUMIZED TIN CANS have won great favor in recent years, first on the West Coast of the U. S. A., and latterly throughout the country. Vacuum-sealing machines exhaust the air and close the containers at the rate of 60 a minute. Private tests by responsible scientists and coffee men are said to have shown that coffee in the bean or ground, when vacuum packed, retains its freshness for a longer period than when packed by any other method.

There are twelve distinct steps in the manufacture of the extra-heavy cans required for this process, each step necessitating extreme accuracy and constant vigilance. It is most important that the can be kept tight when sealed under vacuum in order that air shall not re-enter the can, as that would spoil the coffee. A tight can is also necessary so that it will hold the pressure when the gas in the coffee is generated. Although the machines are highly perfected and as accurate as machines can be, the most rigid supervision prevails throughout the progress of the parts as they pass from one machine to another. Extremely fine measurements are used. The diameter of the can, for example, must be kept within ten thousandths of an inch of the specification. A leeway of only three or five thousandths of an inch is quite common for other parts of the can.

The complete line of eleven vacuum can manufacturing machines operated jointly with connecting elevators and runways and with the cans moving with surprising speed from one unit to another is an interesting spectacle and a fine example of American mechanical ingenuity. All the machines are equipped with automatic stops. In case of

trouble no machine resumes operation without an inspector's approval.

#### *Vacuum Packing*

Coffee, like other food products, deteriorates with age unless protected to insure freshness. Some foods deteriorate by losing their moisture and becoming dry and hard, some by molds and rot, and some by a change of flavor and odor caused by the attack of oxygen. Coffee is one of the latter. Oils and fats soon become rancid and oxygen is the greatest factor in this spoilage, always acting more rapidly when there is heat; wherefore oils and fats remain fresh longest when kept at a low temperature.

Scientific research has demonstrated that coffee is by weight from 13 to 15 per cent oil and fat, and when exposed to the oxygen of the air, particularly in the case of ground coffee, these oils and fats deteriorate rapidly. Such coffee is spoken of as "stale" and its oil is said to be "rancid."

The sale of stale coffee has been termed one of the greatest drawbacks to increased consumption, while freshness encourages its use and increases sales. Therefore, considerations of coffee freshness have led to the blazing of new trails in coffee research and the invention of vacuum packing of coffee; new ideas which have revolutionized packing methods in many roasting plants throughout the country.

Mr. Edwin Norton, of Norton Bros., Chicago, patented in 1900 a machine for closing tin food containers in a vacuum chamber, and he soon discovered that coffee would retain its aromatic qualities, and not become stale when so packed.

The first commercial use of this method was made in San Francisco in the latter part of 1903 by Hills Brothers. Within the next ten years all of the largest packers west of the Rockies adopted this system, and in the latter part of 1918 J. A. Folger & Co., of San Francisco, started the system east of the Rocky Mountains at their Kansas City branch. Three years later other packers in mid-west and eastern states commenced to use it and since then it has spread to practically all sections of the country, until the coffee packed in vacuum is second in tonnage only to coffee packaged in paper bags and greater than that sold in all other types of containers.

The security obtained through vacuum packing is not to be had without additional cost, however, as the container is more expensive than other forms of containers. The fact that coffee packed in vacuum can be sold in volume to the retailer and retained on his shelf without deterioration, eliminating the cost of returned stale coffee, somewhat offsets the higher cost of the container.

It is claimed by protagonists of the vacuum method of packing coffee that the scientific reason why vacuum-packed coffee retains its aromatic freshness is because the oxygen of the air is eliminated and, the package being sealed, the aromatic flavors cannot evaporate. This has been confirmed in substance by Drs. Walter H. Eddy and Percy W. Punnett, of Teachers College, Columbia University, New York, who, as a result of a research into coffee aroma and freshness, sponsored by the American Can Company, reported that:

The loss of freshness is mainly a volatilization process accelerated by the evolution of "roast" gases from the product. Since the roast gas is mainly CO<sub>2</sub>, it seems reasonable to believe that the "stale" taste is due to oxidation of the coffee oils which, of course, does not begin so long as the gas is there to fend off the oxidation of the air. The roast gases, then, appear closely connected with flavor loss in loose coffee—preventing the access of oxygen to the coffee and indicating the degree of freshness. . . . Rate of freshness losses are not so different in the ground and whole-bean coffees as was expected. The development of staleness, however, was definitely slower in the bean coffee.<sup>4</sup>

The final conclusion of Drs. Eddy and Punnett was that a gas-tight container appeared to be the best means of holding the flavor of roasted coffee over a long period of time. This part of their report brings out, incidentally, the reason for the heavier weight and consequent higher cost of vacuum containers:

The high pressure excited by the escaping gases makes a hermetically sealed container impractical unless it is much stronger than ordinary tin cans. Vacuum packing permits the use of ordinary tin plate by compensating for the inevitable pressure with an initial vacuum. Furthermore, it fulfills the second condition for the preservation of flavor by removing over 90 per cent of the oxygen which otherwise would be present in the can. It is one practical method for holding coffee without loss of flavor. Until another type of container is evolved of equal potency in gas re-

tention, the only other protection against stale coffee seems to be close proximity of consumer and roasting plant, and the quickest possible distribution. Unless packed in hermetically sealed containers coffee should be used up before it has a chance to lose freshness or acquire stale flavor.

Coffee is highly absorbent of flavor. This is especially noticeable of flavors foreign to coffee. If a small particle of kerosene oil were put into a container packed with coffee, the entire quantity of coffee would contain the flavor of kerosene oil in a short time. With the oxygen eliminated and the coffee flavors hermetically sealed, vacuum-packed coffee is surrounded constantly by its own aromatic flavors.

When coffee is roasted, a large volume of CO<sub>2</sub> gas is developed in the bean, as previously mentioned. The darker the roast, the more CO<sub>2</sub> gas is formed. There is practically three times as much gas in French or Italian roasted coffee as there is in a light roast. The other commercial roasts are called medium and dark roasts. There is no absolute standard for these colors. When the coffee is ground some of the CO<sub>2</sub> gas is lost by the breaking of the minute cells. However, there is enough CO<sub>2</sub> gas left in the cells of the ground coffee to completely fill the vacuumized space surrounding the coffee if the coffee is packed immediately after being ground, and there will be no vacuum in the can. Also, as is obvious, there will be no oxygen to deteriorate the coffee. Coffee has been kept fresh by this method for five years.

A manufacturer of vacuum cans states that during the period from June, 1931, to June, 1935, a time of economic depression, when the tendency was to economize, consumers in the United States more than doubled their purchases of coffee packed in vacuum although they paid from 6 to 8 cents more per pound for coffee in this form than if purchased in paper bags or certain other types of containers. This record is believed to be an indication of the desire of consumers for fresh coffee and of their belief that vacuum packing maintains freshness.

### *Labeling Coffee*

Coffee packers must give due attention to certain well-defined laws bearing on package labels. Before the Federal Pure Food Act went into effect on January 1, 1907, many coffee labels bore the magic

<sup>4</sup> *Tea and Coffee Trade Journal*, November, 1932 (pp. 429-34).

names of "Mocha" and "Java," when in fact neither of those two celebrated coffees were used in the blend. Even mixtures containing a large percentage of chicory, or other addition, were labeled "Pure Mocha and Java Coffee." The enactment of the Pure Food Law, June 30, 1906, ended this practice, making it compulsory that the label should state either the actual coffees used in the blend, or a brand name, together with the general description "Coffee" and the net weight of the contents of the package.

When chicory or other addition is used, the fact must be stated in clear type directly following the brand name on the label; for example, it is required that a mixture of coffee and chicory must be labeled "Coffee and Chicory," with all of the words in the designation given equal prominence. The name of the predominating component should appear first.

In addition to the Federal law a number of states have special statutes with respect to the labeling of coffee and chicory. In Pennsylvania and Maryland, for example, there are identical statutory provisions which are, in effect, that the amount of chicory shall not exceed 15 per cent of the mixture, and that the package shall bear the words "Coffee and Chicory" in letters of the same size and style, but not less than 1/2 inch in height; also, the mixture may contain no cereal in any form, and if sold in hotels or restaurants it is necessary to display a placard bearing the words, "The coffee sold here is mixed with chicory."

While the use of cereal with coffee and chicory is prohibited in the states mentioned, the sale of coffee and cereal in a properly labeled package is, of course, permissible.

The Federal Pure Food Law requires that where one element of a blend is specified on a label, all elements must be specified in the order of their importance. Thus it is a violation of the law to state on a label: "X brand contains genuine Mocha" or "X brand, a blend of Mocha and Java and other fine coffees."

Only in cases where the brand is 100 per cent Mocha or Java, or solely a blend of the two, may the names "Mocha," "Java," or "A blend of Mocha and Java" be used. Otherwise, all of the elements of the blend are required to be specified in the order or percentage of their importance.

For instance, a blend containing 50 per cent Santos, 30 per cent Colombians, 10 per cent Mocha, and 10 per cent Java would properly be labeled "X brand, a blend of Santos, Colombians, Mocha, and Java," if it is desired to mention the Mocha and Java. If it is not so desired, it only is necessary to use the packers brand name.

The principle of these regulations was given further confirmation by the Associated Coffee Industries Code of Fair Trade Practices under Section III, which lists as an unfair trade practice:

The use of cereals, chicory, coffee screenings, or other products compounded with coffee, unless containers be plainly and conspicuously labeled to indicate the presence of such ingredients.

As to coated coffees, the U. S. Department of Agriculture has ruled that all substances used for glazing must be declared on the label; for example, the label must show "Coated with lemon juice, flaxseed oil, gelatin, bicarbonate of soda, and lime water," if such is the case. Coloring matter or other substance employed to change the tint of coffee is likewise required to be declared on the label. It should be noted, however, that proper labeling alone does not remove an article from the operation of the law if a poisonous or deleterious ingredient has been introduced.

By far the greater majority of package coffees in the United States are given no other treatment than painstakingly careful roasting at the hands of experts, and are labeled only with the packers trademark brand as, for a few examples: "Bokar," "Maxwell House," "Chase & Sanborn's," "Yuban," "Monarch," and "Folger's Golden Gate." In all such instances neither the law nor the Coffee Code impose any further labeling obligation than correct statements of net weight, and character of the product, which in the examples mentioned is, of course, "Coffee."

Section 8 of the Pure Food Law reads:

THE NAME OF THE MANUFACTURER OR PRODUCER need not be given upon the label, but if given it must be the true name. The words "Packed for \_\_\_\_\_," "Distributed by \_\_\_\_\_," or some equivalent phrase, may not be added to the label in case the name which appears upon the label is not that of the actual manufacturer or producer.

THE PLACE OF MANUFACTURE or production need not be given upon the label except where, in order to avoid misbranding, it is necessary

to indicate clearly that the article is of domestic and not foreign origin. . . The place of manufacture or production, if given, must be correctly stated. When a person, firm, or corporation actually manufactures or produces a food or drug in two or more places, the actual place of manufacture or production of each particular package need not be stated on the label except when the mention of any place, to the exclusion of the others, deceives or misleads.

#### *Practical Grocer Helps*

Wholesale coffee merchandising does not properly end with the delivery of a shipment of coffee to a retailer. The progressive wholesaler knows that it is to his best interest to help the grocer sell his coffee as quickly as possible; to make a good profit on a quick turnover; and to dispose of it before the coffee has deteriorated.

Practical cooperation between wholesaler and retailer is one of the most important factors in coffee merchandising. In these days of keen and unremitting competition, neither agency can stand alone for long, in fact some wholesale houses now have their own chains of retail stores, while others act as wholesale buying agents for voluntarily organized chains of independent retail dealers. The progressive wholesaler does not sell a retail shop a poorer quality of coffee of any particular grade than its trade calls for, and he does not load it up with more than can be disposed of while still fresh. He gauges the capacity and facilities of each retail shop, and then gives it practical help to keep the stock moving.

The packer of branded coffees helps by advertising to the consumer in magazines and newspapers, always featuring the name of his brands; and he supplies the grocer with educational pamphlets and booklets on the growing, preparation, and merits of coffee in general, with an added fillip about the desirability of his particular brand. Through his salesmen the packer shows the grocer how to display the coffee on the counter and in the window, and often supplies him with placards and cut-outs featuring his brand. He cooperates in staging special coffee demonstrations in the store; instructs the retailer in the importance of teaching his clerks how to talk and to sell coffee intelligently; and how to prepare advertising copy for his local newspaper, so as to get the fullest measure of profit from the wholesaler's national or sectional advertising.

#### *Coffee Sampling*

The sampling method of creating a demand for merchandise has been tried in the wholesale coffee trade, only to be abandoned by the majority of packers. With other and more satisfactory ways of creating consumer interest, promiscuous sampling was found to be too expensive, in view of the comparatively small returns. One indictment against sampling is that it does not make any more impression on the average person than does an advertisement that appears only once, and is then abandoned. Wide-awake merchants have learned that the public's memory is exceedingly short; and that they must keep "hammering" with advertisements to establish and to maintain a demand for their products.

It would seem that the logical place for sampling is in the retailer's store, especially in connection with demonstrations. Many progressive grocers stimulate interest in their coffees by serving, on special demonstration days, small cups of freshly brewed coffee, giving the customer a small sample of the brand or blend used, to be taken home to see if the same pleasing results can be obtained there also. Generally this form of sampling, when properly conducted, has shown a larger percentage of returns than any other method.

#### *Premium Method of Sales Promotion*

For many years, the premium method of sales promotion has been an important factor in wholesale coffee merchandising, as well as in retail distribution. The premium system has been characterized as a form of advertising; and many coffee packers and wholesalers prefer to spend their advertising appropriations in that way rather than in transitory printed advertisements in newspapers and general magazines.

While certain forms of the system have been legislated out of existence in some states, friends of the plan claim that it is a true profit-sharing method which "blesses both him that gives and him that takes"; and that it is an advanced and legitimate means of promoting business, when properly conducted. They assert that it is a system of sales promotion whereby the advertising expense, plus a large percentage of the profits of the business stimulated thereby, is automatically returned to the dealer buyer, without increasing cost or



lowering the quality of the product so advertised; that it eliminates advertising waste by producing a given volume of sales for a given expenditure of money; that it reduces the cost of advertising by prompting a continuous series of purchases at one advertising expense; that it promotes cash payments and discourages credit business. Premium users claim that the force of a printed advertisement is often spent in stimulating the first purchase; while to secure a premium, the purchaser must continue to buy the commodity carrying the premium, or trade with the giver of the premium until merchandise of a stipulated value or quantity has been purchased.

In general practice, the premium-giving coffee packer or wholesaler may offer a household article to the consumer through the retailers.

In giving premiums to consumers, the wholesaler packs coupons with the coffee that are redeemable at the retailer's store. Sometimes, however, the consumer sends the coupons or certificates to the wholesaler, getting the premium direct from him. In another phase of the premium system, the retailer works independently of the wholesaler, buying and giving away his own premiums to promote or to hold trade for his store. This phase is explained in the chapter on retail coffee merchandising.

#### *Chain Stores and the Wholesalers*

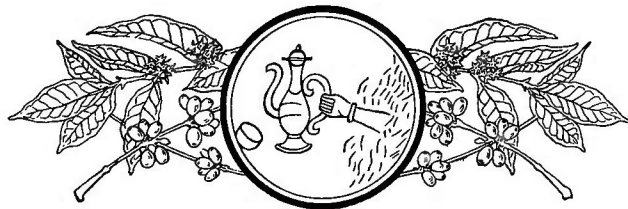
In the United States, the development of chain stores has revolutionized retail-grocery merchandising and has created a

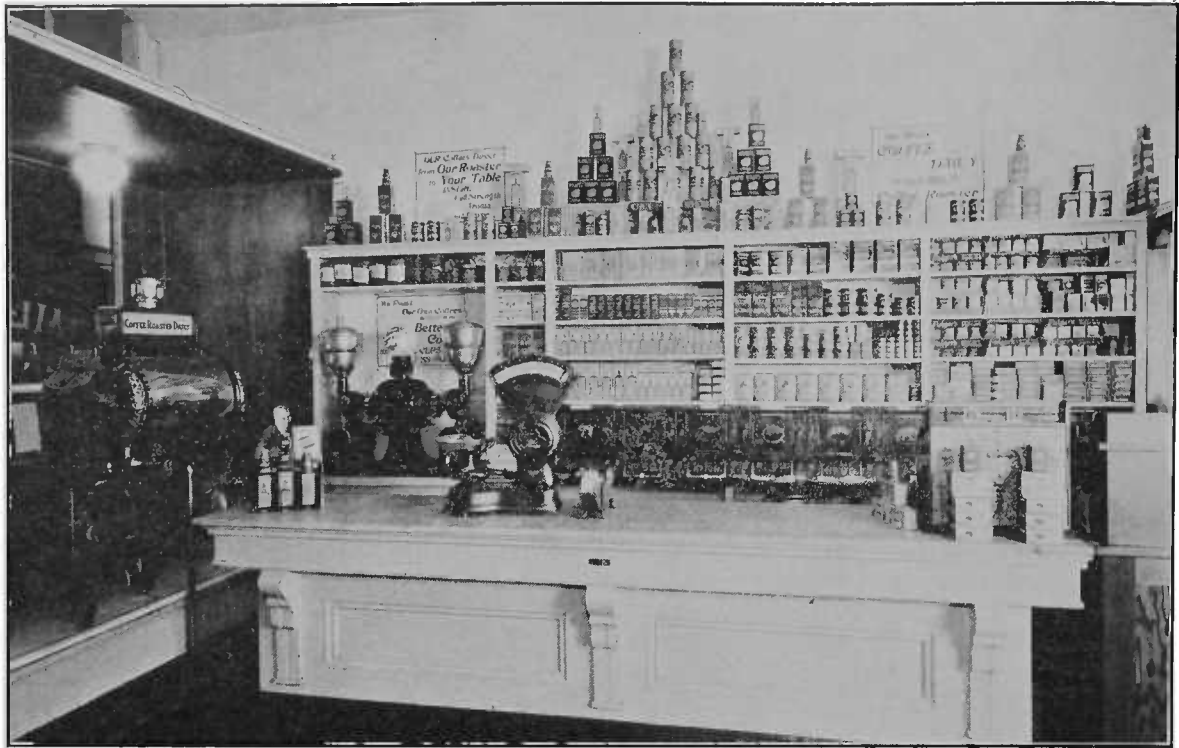
distinct problem for the wholesale coffee distributor. These chain store concerns, one of them having about 16,000 stores, and a number maintaining hundreds of units, have effected buying and operating economies which have made it increasingly difficult for the independent grocer to survive. As a consequence the number of independents has been materially cut down and this has curtailed the wholesaler's normal outlets for the sale of his coffee.

There are two distinct types of chain grocers in the United States; viz.: corporate chains, operating stores either nationally, sectionally, or locally; and so-called voluntary chains. The latter represent an effort on the part of wholesalers and retailers to combat the competition of the corporate, or regular chains.

Under the heading of voluntary chains there is the jobber-retailer type. In this case the wholesaler sponsors a group of independent merchants who buy and sell cooperatively. Under this plan, the retailer purchases much of his merchandise from the wholesaler operating the chain; the retail group thus obtaining the benefits of quantity buying and group merchandising.

There is also the retailer-owned type of voluntary chain. These buy cooperatively, maintaining their own buying organization and warehouses. Many chains of this character purchase their coffee from wholesale coffee-specialty firms, and this is one way in which the latter are overcoming the loss of business from independent retailers, brought about by the competition of the corporate chains.





THE INTERIOR OF RANDALL-MCMILLAN'S STORE, PALO ALTO, CALIFORNIA

The roasting machine is located in the show window where it attracts the attention of passersby, while the grinding mill is conveniently located nearby.



EXTERIOR OF A RETAIL STORE IN ALSACE, FRANCE

Note the array of coffee-dispensing canisters at the rear of the store and the samples of raw and roasted coffee in the window. The roaster is shown at the right.

RETAIL SPECIALTY STORES, FEATURING FRESHLY ROASTED COFFEE

## CHAPTER XXVIII

### RETAIL MERCHANDISING OF COFFEE

HOW COFFEES ARE SOLD AT RETAIL—THE PLACE OF THE CHAIN STORE, THE INDEPENDENT RETAILER, THE TEA AND COFFEE DEALER, AND THE DELIVERY-ROUTE RETAILER IN THE SCHEME OF DISTRIBUTION—PREMIUMS FOR CUSTOMERS—STARTING IN THE RETAIL COFFEE BUSINESS—SMALL ROASTERS FOR RETAIL DEALERS—MODEL COFFEE DEPARTMENTS—CREATING A COFFEE TRADE—MEETING COMPETITION—FIGURING COSTS AND PROFITS

COFFEE is sold at retail in the United States through ten distinct channels of trade: chain grocery stores; independent retailers, including grocers, delicatessen, super-food markets, etc.; home-service (door to door) distributors; tea and coffee specialty shops; department stores; drug stores; mail-order houses; co-operative stores; commissary stores; and restaurants selling their own branded coffee. However, the percentages of coffee sold outside of chain grocery stores, independent retailers, and tea and coffee specialty shops are so small, comparatively, as to become almost negligible where general statistics are concerned. A survey<sup>1</sup> conducted in various parts of the United States in 1932, showed that 55 per cent of the families bought coffee from the chain grocery stores; 27 per cent got theirs from independent retailers; while 7 per cent patronized coffee specialists, and 11 per cent was represented by purchases from all other sources. The survey also indicated that chain stores sell their largest share of coffee to medium- and low-income classes, while independent retailers have their principal business with high- and medium-income families, and the specialty stores make their best showing in sales to medium-income clientele.

Considering the methods of merchandising, the ten retail distributing agencies may be grouped into three distinct classes.

The first class would comprise the chains, the independent retailers, the department stores, the drug stores, the specialty shops (including premium stores), the co-operative stores, the commissary stores, and restaurants selling package coffee, all of which maintain places where the consumer comes to buy. The second class takes in the mail-order house, which solicits orders and delivers its coffee by mail, and sometimes by freight or express. The third class covers the home-service dealer, who goes from house to house seeking trade, and delivers his coffee on order at regular periods direct to the consumer in the home. As an inducement to contracting for large quantities to be delivered in weekly or bi-weekly periods, the house-to-house dealer generally gives household articles, or the like, as a premium to establish good-will and to retain the trade of his customers.

New impetus was given to the method of selling coffee by mail when the parcel post system was adopted by the Federal Government in 1912; and since then this plan has become an important factor in retail coffee-merchandising. Generally, the mail-order houses confine their sales efforts to agricultural districts and small towns, soliciting trade by catalogs, by circular letters, and by advertisements in local newspapers, and in magazines which circulate chiefly among dwellers in rural districts.

#### *Home-Service Merchants*

The majority of home-service distributors depend upon the appeal of their pre-

<sup>1</sup>"American Coffee Habits Survey, No. 2," by the Brazilian-Am. Coffee Prom. Comm. *Tea and Coffee Trade Journal*. April, 1932, p. 393.



A HOME-SERVICE MERCHANT'S PREMIUM DISPLAY ROOM

Most of the delivery-route dealers in the United States feature premiums in their sales of coffee and other products. The above is a section of the store of Geo. F. Hellick Co., Easton, Pa.

miums, and on personal calls, to develop and to hold their coffee trade. The leading companies, which are entirely distinct from so-called "premium houses," maintain offices and plants in large cities adjacent to the territories to which they confine their sales efforts. The premium stores are interested only in making single sales, while home-service firms try to attract and hold steady customers on standing orders. At strategic points, home-service district agents engage route men for the actual soliciting of orders and delivery of coffee. All delivery-route companies handle other products besides coffee, specializing in tea, spices, extracts, and such household goods as soap, perfumes, and other toilet requisites that promise a quick sale and frequent re-orders. Some of their competitors complain that they handle only the more profitable lines, leaving the independent local grocer to supply the housekeeper with items on which the margin of profit is comparatively small.

Home-service coffee-retailing began to make itself felt seriously about the year 1900. At first, the premiums usually consisted of a cup and saucer with the first order, the customer being led to continue

buying until at least a full set of dishes had been acquired. Later, the range of premiums was expanded; until today the home-service man offers several hundred different articles that can be used in the home or for personal wear or adornment. Practically all the leading delivery-route concerns favor the advance premium method; that is, a special canvasser induces a consumer to contract for a large quantity of coffee and other products in return for receiving the premium at once, though the coffee is delivered only as the customer wants it, generally two pounds every two weeks. The premium represents the home-service firm's advertising medium. The route man delivers the coffee, and is usually held responsible for the customer fulfilling the agreement, and is expected to secure repeat orders with other premiums.

The importance of the home-service plan of coffee-retailing is shown by the fact that in 1935 there were over five hundred houses of this kind in the United States; and it was estimated that they distributed eight per cent of the total amount of the coffee consumed in the country. The biggest company operated 1,462 routes. Most of the home-service concerns were operat-

ing in the central states, practically one-third of them covering the states of Illinois, Wisconsin, Indiana, and Iowa. Pennsylvania is also a delivery-route-dealer center.

The premium home-service distributors have an organization called the National Retail Tea and Coffee Merchants' Association. It is composed of 195 members—most of whom use premiums—who operate over five thousand delivery routes.

The largest home-service operator is the JEWEL TEA Co., INC., of Barrington, Ill., a suburb of Chicago. The company has 82 branches, 1,462 delivery routes, and 87 self-service stores (in Chicago area), serving a million families in 42 States and the District of Columbia. They sell 58 products in the grocery line, 32 of which—including coffee—are packed at the Barrington plant. Jewel specializes in the freshness and excellence of their coffee which constitutes 50 per cent of the company's total sales. Numerous premiums are provided as sales aids; also contests and campaigns at intervals throughout the year to stimulate the sales force. The regular annual dividend rate on the 280,000 shares of no-par common stock is \$3.00 per share. In 1934, the earnings per share were \$4.44. M. H. Karker is president and John M. Hancock is chairman of the board.

#### *Premiums for Customers*

House-to-house dealers are the largest users of premiums among coffee distributors. Most of them operate under the advance-premium method.

The plan followed by house-to-house dealers until about 1910 was to issue checks redeemable in premiums after a certain amount of tea, coffee, or other products had been purchased. This practice has not



EXTERIOR OF AN AUSTRIAN MULTIPLE COFFEE AND TEA SPECIALTY SHOP

been entirely abandoned; but in most instances, the premium is now handed to the consumer in advance of the initial purchase, in consideration of the buyer's promise to use a stipulated quantity of tea, coffee, or other merchandise. The driver of the wagon generally carries a portfolio illustrating numerous premium items redeemable through the purchase of varying amounts of merchandise.

It is significant that one of the largest chain-store organizations in the United States—the Great Atlantic & Pacific Tea Company—uses few premiums today, although its business was founded on the premium idea.

Trading stamps, which are sold to grocers and other merchants by firms making a specialty of this form of premium-giving are little used nowadays. The average retail grocer is antagonistic to trading stamps, as a result of the methods of certain unscrupulous stamp-dealers. Legislation against trading stamps is in effect in many states.

#### *Chain Stores*

In the chain-store system of merchandising we see the opposite extreme of coffee retailing. The delivery-route man features his delivery service; while in the chain-store plan, all customers must pay cash and carry home their parcels. Though the earliest established chain stores gave premiums, the practice has been generally abandoned. Roasting, blending, and packing coffee in a large central plant, the chain-store operator advertises that he can sell coffee at a price lower than his competitors. As a rule, chain stores carry three or more



WINDOW DISPLAY OF COFFEE IN A VIENNESE SPECIALTY SHOP





EXTERIOR OF AN AMERICAN CHAIN STORE  
Window display includes the firm's three principal coffee brands.

trade-marked brands of their own and the nationally advertised brands.

There are four types of food store chains now being operated in the United States. They are: (1) the regular chains, like the A. & P., etc., which do their own large-scale buying and sell through retail branch stores; (2) the so-called "voluntary" chains, conducted by wholesale grocers, but operated by individuals on a co-operative basis; (3) chains owned and operated by wholesale grocers, like the Royal Scarlet Stores, Inc., in New York, owned and operated by R. C. Williams & Co., wholesale grocers; and (4) groups of retail grocers like the Independent Grocers Alliance, purchasing from a single buying unit, such as Seeman Bros., wholesale grocers, New York, and many others. The stores operate under a distinguishing name, such as the United Grocers, in New Jersey.

There are approximately 750 chain food-store organizations in the United States, having four or more stores each.

THE GREAT ATLANTIC & PACIFIC TEA COMPANY of America is the largest distributor of coffee in the United States with 15,600 retail stores in thirty-five states and two Canadian provinces, the total annual coffee output averaging about 200,000,000 pounds, or 14 per cent of the total U. S. coffee imports. The company maintains eight roasting plants scattered over the United States.

The firm was founded in 1859, the original company, now a subsidiary, being known as the Great American Tea Company. The founders, Messrs. George F. Gilman and George H. Hartford, conceived

the idea of buying coffee, tea, and spices in large quantities and selling them to consumers at less than prevailing prices. Goods were shipped to agents who made up "club" or group orders and then delivered the merchandise for a premium or other compensation.

In 1869, a second company was organized to operate a chain of stores, being named the Great Atlantic & Pacific Tea Company. This separate company was created to segregate the store business from the original mail-order enterprise and the wagon-route business that grew out of it. Both were a success but the store business far outgrew the other.

The Great Atlantic & Pacific Tea Company is the recognized leader in chain-grocery merchandising in the United States. Coffee has always been a featured item with this concern and in its coffee publicity the firm has sought to develop consumption as well as sales. The company maintains its own buying organization in the principal coffee producing countries, operating under the name of the American Coffee Corporation. Berent Friele is president of this corporation.

Under Mr. Friele's direction the foreign organization has been developed on a large scale and in keeping with this firm's vast coffee requirements. In Brazil, the company has twelve offices at strategic points, one at Rio, another at Santos, and ten in the interior. In Colombia there are forty buying agents operating out of six main offices. To promote quality and uniformity the company has established a warehouse at Santos where the coffees are blended. In Colombia the coffees are processed in the firm's own mills.



EXTERIOR OF A NEIGHBORHOOD FOOD STORE  
This wholesaler-owned chain store in New York illustrates the size and attractiveness of this type of food shop.



INTERIOR OF A MODERN CHAIN FOOD STORE IN THE UNITED STATES

A Great Atlantic and Pacific Tea Company store in New Jersey. The present tendency in chain food store merchandising is to combine the sale of meats, groceries, etc., in one store. Coffee is a featured product with the chains.

Progressiveness characterizes all of the operations of the coffee department. The firm has developed its own automatic coffee-roasting equipment. It has perfected machinery for making special bags, in which most of its coffee is packed. The aim is to give the consumer fresh-roasted and freshly ground coffee. To this end, only coffee in the bean reaches the stores where it is ground as sold, to meet the customer's particular grind requirements, using a new type of coffee mill, which makes certain that the consumer gets a uniform grind of exactly the desired size without the risk of error on the part of the clerk.

The remarkable development of the Great Atlantic & Pacific Tea Company's coffee business is largely attributable, in the opinion of the management, to its efficient organization in the producing countries, making it possible for the firm to obtain the coffees that best meet its requirements under the most favorable conditions and to assure uniform quality.

Practically all the leading grocery chains and many of the smaller companies are affiliated with the FOOD AND GROCERY

CHAIN STORES OF AMERICA, INC., which has its headquarters in the National Press Building, Washington, D. C. This trade association is comprised of 160 members of the trade, representing 23,000 stores operating in all 48 states, the District of Columbia, and Hawaii.

The chain-store grocer turns his stock from 12 to 25 times a year, sells for cash, and in general makes no deliveries, thereby effecting operating economies variously estimated at from four to seven per cent. In addition to these economies chain grocers make other savings by means of quantity purchases negotiated by experts in each type of product.

Chain-store grocers operate on an average net margin of from 2 per cent to 3 per cent of sales. Their average gross cost of doing business has been stated as between 12½ per cent and 18 per cent with savings to consumers over a full line of purchases variously calculated as between 7½ per cent and 13½ per cent.

According to John A. Logan, executive vice-president of the Food and Grocery Chain Stores of America, "The consuming

public is becoming increasingly aware of the numerous advantages such as full stocks, cleanliness, quality standards, and courtesy, as well as the substantial money savings offered by food and grocery chain stores. Almost every chain organization, large and small, began as a single store unit but because of the ability and ambition of its owner was expanded. Consumer approval of mass distribution of food and grocery products is best exemplified by the growth of multiple unit grocers.

"Many prominent chain groups began as tea, coffee, and spice distributors and their success in this line led to expansion into a general grocery business. In almost all cases chain groups still place great emphasis on the quality of their tea and coffee products. Coffee has become such an important item with many chain grocers that special coffee reports are compiled weekly for each store in the system and, because of this special attention, sales of coffee by all chain stores have grown to be a major factor in the coffee industry of the country."

#### *Starting in the Retail Coffee Business*

It is estimated that more than 90 per cent of the roasted coffee sold by retailers today is in ready-weighed, trade-marked packages. Usually the coffee is ready-ground also, although some of the chains make a specialty of grinding it when sold. Bulk, roasted coffee is sold by retailers in ever-diminishing proportion to the sales of package coffee. It is purchased by the dealer in 132-pound or other-sized bags, and is ground as sold. Usually the roaster supplies the dealer with 1-pound paper bags imprinted with the dealers name and the brand name of the coffee. Still a smaller proportion of the coffee sold at retail is purchased green, and then is blended and roasted by the dealer. The larger chains follow the latter plan, packing their own trade-marked blends, while smaller chains and some independent dealers have their own private brands blended, roasted, and packed by custom roasters who specialize in this work.

When taking up the retail merchandising of coffee, the grocer who intends to do his own blending learns all he can about the popular grades to be had in the principal markets, and how the coffees are

grown, roasted, blended, and ground. He also ascertains the best methods of brewing, testing out each grade and kind on his own table, if he does not have testing facilities in his store. He studies the relative trade values of different varieties of coffee, and the requirements of his particular clientele.

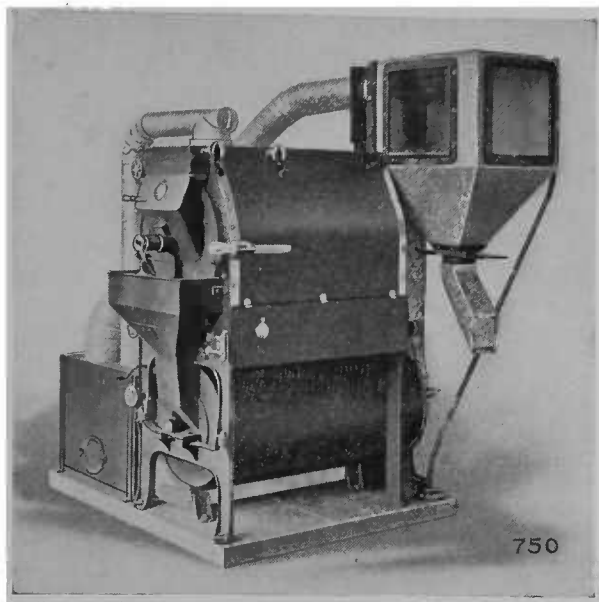
Beyond acquiring a general talking knowledge about coffees, the retailer buying his stocks roasted in bulk or package form does not generally need the intimate knowledge of his goods required by the grocer who roasts his own coffee. If he grinds the coffee for his customers he must know the type of grind best suited to the way the coffee is to be brewed, and must be able to tell the best brewing method.

The practical grocer who makes up his own blend must be acquainted with blending principles and methods. While he can not expect to be as expert as the large wholesale blender, he should know that green coffees are generally classified by blenders in five great divisions: (1) Brazils, including Santos Bourbon and flat-bean, Rios, Victorias, and Bahias; (2) Washed milds, embracing, as of the most commercial value, Colombians, Guatemalas, Mexicans, Costa Ricans, Maracaibos, and Meridas; (3) Unwashed milds, such as Maracaibos, Puerto Cabellos, Salvadors, and Mexicans; (4) Javas and Sumatras; (5) Mocha, and Harari.

It has been found by experience that a good assortment for the retailer who stocks bulk coffee consists of Santos, because of price; a natural unwashed Maracaibo or Cúcuta, because of full body and general blending values; and a washed coffee, preferably a Colombian, which gives quality and character to a blend. In stocking up with these coffees, the practical merchant avoids Santos with a strong or Rioy flavor, bitter or "hidey" Maracaibos, and acidy or thin Colombians.<sup>1</sup>

A grocer equipped with these coffees has the Santos for his low-priced seller. For his medium grade he blends Santos and Maracaibo, half-and-half. The next higher grade is made up of one-third each of the three coffees; while the best blend consists either of half-and-half Colombian and Maracaibo, or three-quarters Colombian and one-quarter Maracaibo.

<sup>2</sup> Duryee, P. S. *Tea and Coffee Trade Jour.*, (vol. xxi: no. 2: pp. 106-110).



BURNS HALF-BAG GAS ROASTING, COOLING, AND STONING OUTFIT

The chief advantage of these three coffees is that they blend well in any way they are mixed; and the dealer with a little experience, and working with the two necessary ideas in mind—satisfactory coffee and price—can make up various combinations.

In view of the fact that the United States imports coffee from more than a hundred different sections of the world, and that there are wide variations in flavor among the coffees produced in each of the hundred, it is easy to understand that the blender has an almost unlimited supply from which to make up a blend with a distinctive individuality. Practically all coffee importers, and most wholesalers, are thoroughly acquainted with the relative trade values of the different coffees, and help their customers make up desirable blends.

#### *Small Roasters for Retail Dealers*

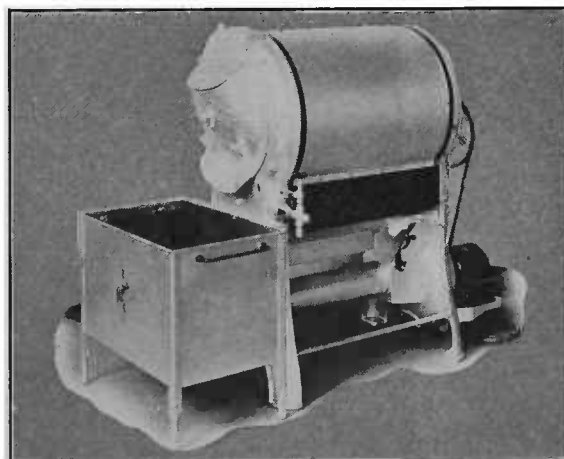
While the wholesale coffee roaster is obliged to install a large and somewhat complex equipment, the retailer must use a small, compact, self-contained unit that does not take up much space in his store, and is easily operated. Retail roasting machines are constructed on the same general principle as the wholesale roaster. The roasting cylinder is generally revolved by electric power, and the heat is derived from gas or gasoline fuel. Cooling is by air

suction in a box attached to the roaster. The capacities of the machines range from ten to three hundred pounds, the operating cost running from approximately eight cents per hundred pounds for gas fuel and ten cents for electric power. The roasters cost from two hundred forty-five dollars for the smaller sizes, to two thousand for the one-bag type; and to thirty-five hundred dollars for the two-bag type.

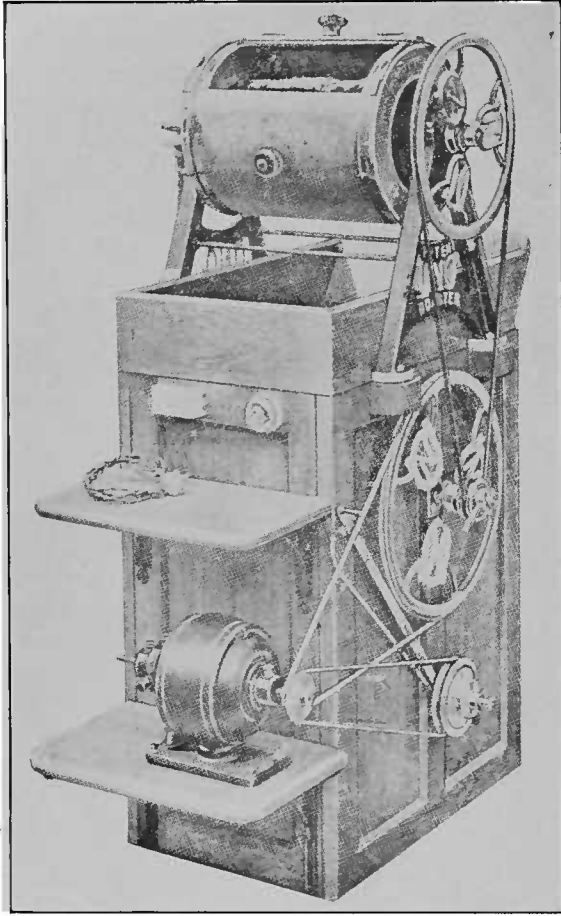
One U. S. coffee-roaster-machinery manufacturer has recently brought out a gas-fired, electrically operated twenty-five-pound miniature coffee-roasting plant designed for retail stores, which comprises a roaster, a cooler, and testing trier, that sells for four hundred seventy-five dollars.

A leading coffee-roasting machinery concern in Germany specializes in the manufacture of small but impressive installations of coffee roasters which are widely used in the stores and show windows of grocers in various parts of Europe. European grocers began to install gas roasters before the wholesalers did. Since 1900, especially in Germany, store installations increased largely in the pre-war years, and again since 1925 when electric-heated roasters also found some adherents, despite their higher operating cost. Even the smallest towns in Germany have retail grocer shops equipped with these roasters. They also are extensively used in Austria, Denmark, Spain and, latterly, in France. Their capacities commonly range from 3 to 12 kilograms, although a larger machine with 15 to 22 kilograms capacity is provided for use in large establishments.

In England there are several types of



THE "ROYAL" GAS COFFEE ROASTER FOR RETAIL STORES



POPULAR TYPE OF ENGLISH GAS COFFEE ROASTER  
The "Uno" seven-pound outfit roasts at a cost of  
12 cents per cwt.

gas and electric coffee roasters available for retailers' stores. They vary in capacity from  $\frac{1}{2}$  pound to 28 pounds.

Retail coffee roasting, whether in Europe or the United States, is similar to the wholesale operation. When the cylinder has become heated, the green coffee is run in and allowed to roast in the revolving cylinder for about half an hour. If the coffee is the average green kind, the full heat may be applied at once; but if old and dry, a lesser degree is used. When the roast begins to snap, the flame is turned lower to allow the beans to cook through evenly; and when nearly done, it is almost extinguished. During the operation, the roasterman, who may be the proprietor or a clerk delegated to the work, frequently "samples" the coffee by taking out a small quantity with his "trier" and comparing the color of the roast with a type sample. When the colors match exactly, the coffee is dumped automatically into the cooler

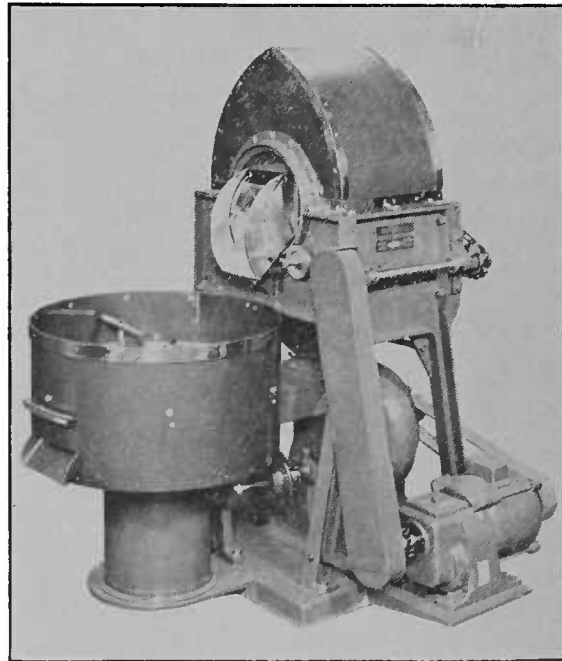
box just below the cylinder opening; and when sufficiently cooled, is ready for grinding to order.

The most successful retail coffee roasters find that besides being able to make a feature of freshly roasted coffee, they can save money and increase their sales. One progressive grocer found that he was able to get eighty-eight pounds of roasted coffee out of one hundred pounds of green coffee, as compared with the wholesaler's eighty-four pounds; that he could buy green coffee at a closer price than roasted; and that it cost him less for labor, fuel, overhead, and similar items, than it did the wholesale roaster to turn out a roast.<sup>3</sup>

#### *Model Coffee Departments*

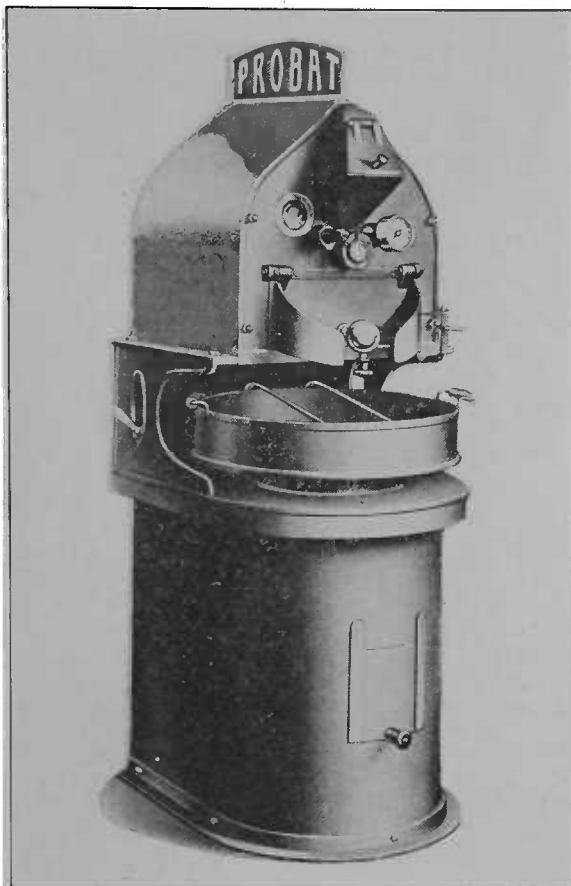
Authorities generally agree that a well laid out coffee department not only increases a grocer's coffee business, but speeds up sales in other departments as well. Coffee lovers, and they are legion in the United States, are inclined to "shop around" for a coffee that suits their taste; and when they have found the store that sells it, they buy their other groceries there

<sup>3</sup> Findlay, Paul. *Tea and Coffee Trade Jour.*, (vol. xxx: no. 1: pp. 72-74).



"SIMPLEX" ROASTING OUTFIT FOR RETAILERS  
An English machine often used for window demonstrations. It is self-contained, with an automatic rotary cooler. Its capacity is 14 pounds.





A GERMAN COFFEE ROASTER AND COOLER

Machines of this and similar types are widely used in Germany, Austria, Denmark, and Spain for display in retail grocer shops. The capacity of this machine is 11 pounds.

also. Another argument advanced in favor of a coffee department is that coffee pays more money into the retailer's cash drawer than any other grocery item.<sup>4</sup>

Most successful retail coffee merchandisers establish the coffee department near the entrance to the store, where it can be seen through a window by passers-by, especially if there is an ornamental roasting and grinding equipment. It has been found that a department situated at the left of the entrance is almost certain to draw attention because people are inclined to glance in that direction first. Some merchants, having the space, erect attractive booths, designed somewhat like the familiar food-show booths, directly in front of the door, after the fashion of department stores when holding a special sale on a certain article. Such a booth is generally used for demonstration purposes, and is decorated

<sup>4</sup>Atha, F. P. *Tea and Coffee Trade Jour.*, (vol. xxxvii: no. 1: p. 50).

with signs and possibly with bunting. A permanent department is usually less ornamental, but still attractive. In telling how he made a success of his department, one American grocer said that he was careful that his fixtures were not so ornamental as to draw attention from the goods. While the decorations were always attractive, they were subordinated sufficiently to form a background for his coffee display.

The most popular layout is the conventional counter system behind which the clerk stands to serve the customer on the other side. There are many advocates of the counter that is built into the shelving, believing that the closer the customers are brought to the coffee, the more they will be inclined to buy. This system also makes for cleanliness, doing away with the possibility of the runway behind the counter becoming a catch-all for dirt, torn paper, bits of wood, and the like.

#### *Modernized Coffee Display*

The modern coffee department has counters divided into compartments having glass fronts. This type serves both as a storage place for coffee and for display



A SEGREGATED STORE COFFEE DISPLAY

The above is an interesting example of a special department devoted to coffee in a retail establishment. The photograph was taken in an A. & P. Super-Food Shop in Brooklyn, New York.



A GOOD EXAMPLE OF A DEPARTMENTALIZED COFFEE DISPLAY, IN AN AMERICAN FOOD SHOP

Here in this segregated coffee section may be found all the equipment necessary for the demonstration and sale of coffee, including scales, coffee mills, and coffee makers, with an orderly display of packaged coffees.

purposes. The top of the counter is used for wrapping up parcels, etc., and for open displays of bulk and package coffees. In the well regulated store, the counter top is never used for storage, all stock being kept on shelves or in the counter's compartments. Good merchants find that cleanliness pays; and that a "littered up" store drives away desirable custom. The wise proprietor knows that few food products in his store will more quickly absorb undesirable odors and flavors than coffee; and consequently he is careful to protect it from contamination. In the better stores, the proprietor will either take charge of the coffee department himself, or will delegate a competent man to do so.

The wide-awake retail coffee roaster always features his roasting machine, which generally is highly ornamental and draws attention even when not in use. Some progressive merchants plan to roast coffee at noon time and at night, when homeward-

bound passers-by are hungry and are particularly susceptible to the pungent aroma. It is a common plan for the retail roaster to arrange the exhaust of the machine so that the full strength of the odor is blown into the street.

Recent developments in the merchandising of tea and coffee at retail in the United States indicate a return to the old-time policy of specializing these lines. Once the outstanding aristocrats of every grocery shop, tea and coffee have been submerged in a welter of other products since packaging became general. However, in every alert community throughout the country, a new type of food mart is springing into existence. These are the super-food markets, independently organized to challenge the food chains, and completely departmentalized. Usually they are huge establishments, many times the size of ordinary food shops, and are somewhat removed from the area of high business rents

as to location, but close to large concentrations of population. Here the housewife may conduct her entire pantry requisitioning under one roof, and here she finds each line impressively displayed.

Under the classification of the most profitable specialties is listed coffee, ranking high on the list because of the quantity used. Too many merchants regard coffee as an ordinary staple, and merchandise it in the same fashion as they do potatoes, meal, rice, beans, and the commonest commodities. But the past several years have seen coffee lifted from the staple classification to a high-grade specialty in many of the newer and more progressive food shops, and the prominence given it has been richly repaid in increased sales and profits.

#### *Creating a Coffee Trade*

Because of steady sales and quick profits, there is keener competition in retail coffee-merchandising than in other food products. But, all things being equal, any intelligent person can create and hold a profitable trade if he follows approved business methods—and works. The best practice among coffee merchants shows that the prime essential is good coffee, freshly roasted and ground. After that comes intelligent and unremitting sales-promotion work.

The many ingenious trade-building plans

worked out successfully by grocers in all parts of the country are too numerous to describe in a book of this character; but the methods cited in the following, all of which have been tested in actual working conditions, will serve to indicate the fundamentals of good retail coffee-sales promotion.

Among the chief sales-winning methods are demonstrations in the store, at local food shows, and at church socials, picnics or functions, judicious sampling either in person or by mail, personal canvassing from house to house, circularizing by mail, linking up window displays with current happenings, local newspaper and outdoor poster advertising, and selling coffee by telephone.

Coffee demonstrations in stores are easily arranged, in most cases. The main consideration is fresh coffee of good quality served daintily and hot. Lacking a coffee urn, some grocers make their brews in home-service coffee-making devices. Those most advanced in the correct method of brewing use the drip process. It is generally agreed that demonstrations should not be held too often. They not only cut into profits, but lose much of their advertising value. Food-show demonstrations require more elaborate equipment, consisting of a decorated booth, educational booklets, posters, and exhibits of different kinds



THE COFFEE DEPARTMENT IN AN AMERICAN SUPER-FOOD MARKET

In many of the larger food emporiums in the United States the various products are departmentalized. The illustration shows how coffee is featured by the Spray Coffee and Spice Company of Denver in a "drive in" market in that city.



FEATURING FRESHLY ROASTED COFFEE IN A SPANISH, OPEN-FRONT REFRESHMENT STAND

of coffee, both green and roasted, whole bean and ground. Generally, coffee packers cooperate with retail demonstrators by supplying gratis the coffee to be brewed, if the names of their brands are suitably displayed. They supply also posters, signs, samples, and booklets for free distribution.

Window displays form one of the best means of advertising at the command of the average grocer, and one of the least expensive. A popular coffee display consists of a series of educational "windows," starting with green beans in the bags in which they are shipped from the growing country. Generally the bags, mats, or bundles are obtained from the wholesale house, and are filled almost to the top with some inexpensive stuffing, the green coffee being spread over the top to give the appearance of a full bag. Pictures showing how the coffee is grown, harvested, prepared, and shipped, frequently are used in such a display. The next exhibit consists of whole roasted coffee spread thickly over the window floor to create the impression of bulk, accompanied by a few pans of green coffee by way of contrast, and with pictures showing scenes in coffee roasting plants. A barrel, lined with blue paper, and lying on its side with roasted coffee

beans spilling out, serves as a centerpiece for such a display. Following this, comes a coffee package window, accompanied by pictures showing how coffee is roasted, ground, and packed. This completes the series; but there are many variations that have proved successful as trade builders.

#### *Meeting Competition*

Since the advent of the delivery-route distributor and the chain store, the independent retail grocer has been faced with the problem of how to regain at least a fair measure of the coffee trade he has lost. The grocer is concerned not only about his profits on coffee sales, but on other goods as well; for a trade investigation has shown that a large percentage of the regular customers of the retailer are held to the store by their purchases of coffee and tea. This means that if coffees and teas are bought from the delivery-route distributor and the chain store, the balance of a family's order is "shopped around."

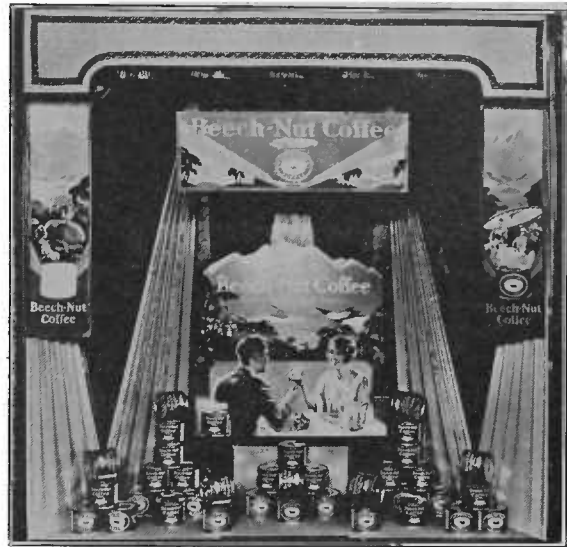
To meet this competition, the best authorities agree that the independent grocer should feature coffee in every practical way, such as soliciting coffee trade from each customer that enters the store; give



up offering coffee on a price basis, and make up his own blends from good quality growths; perhaps make up his own brand and push it at every opportunity; display coffee artistically, with frequent changes of layouts; and have occasional store demonstrations. He should see that the coffee is roasted properly, and that it is always fresh; that the selling effort is not expended on the lowest-priced blend, but on a grade that can be recommended for cup merit. This should be a leader, but a lower-price coffee could be carried to suit the trade that buys on price. Persistent efforts should be made to educate the last-named class of customers to use the better grades, which in the end are cheaper and give better satisfaction. In short, the grocers should work consistently to establish a vogue for his leader blend on the basis of merit.

*Profits and Costs*

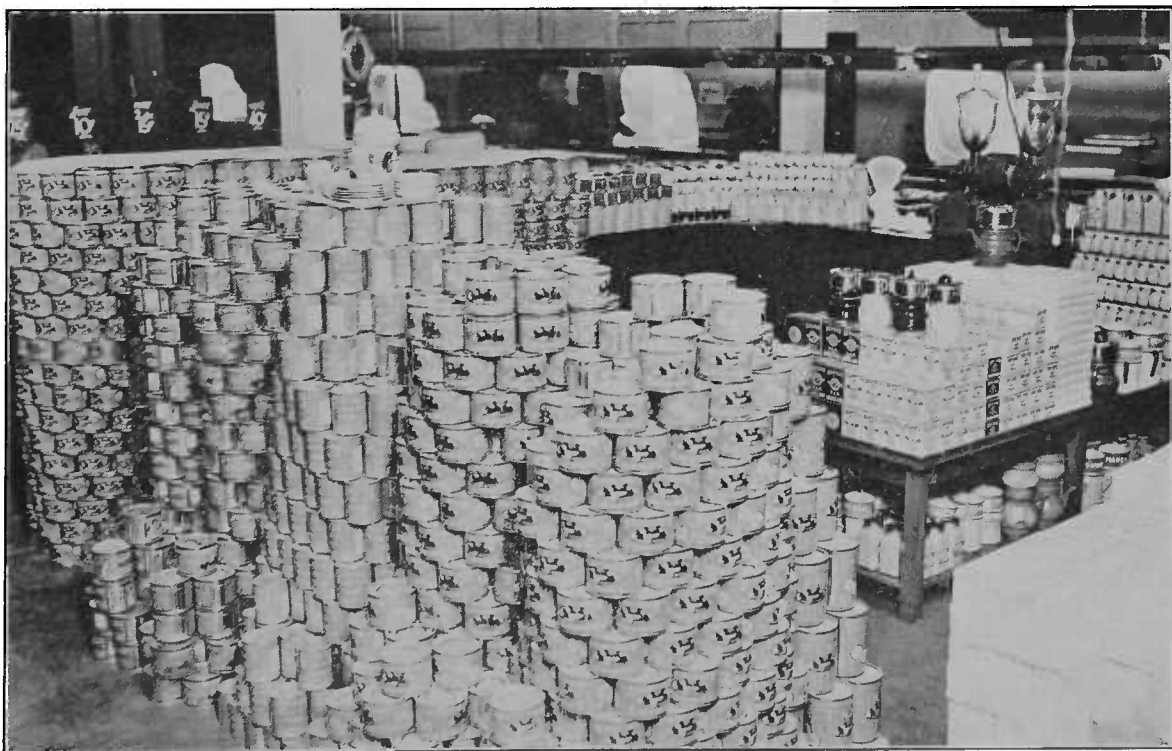
Because of its influence on other grocery items, coffee can often be sold at a close margin of profit, particularly if a competitor's store or wagons are cutting into a



A PACKAGE-COFFEE WINDOW DISPLAY

Many coffee roasters in the United States supply the dealer with ready-made window trims to tie-in with their other advertising, and as a service to the dealer.

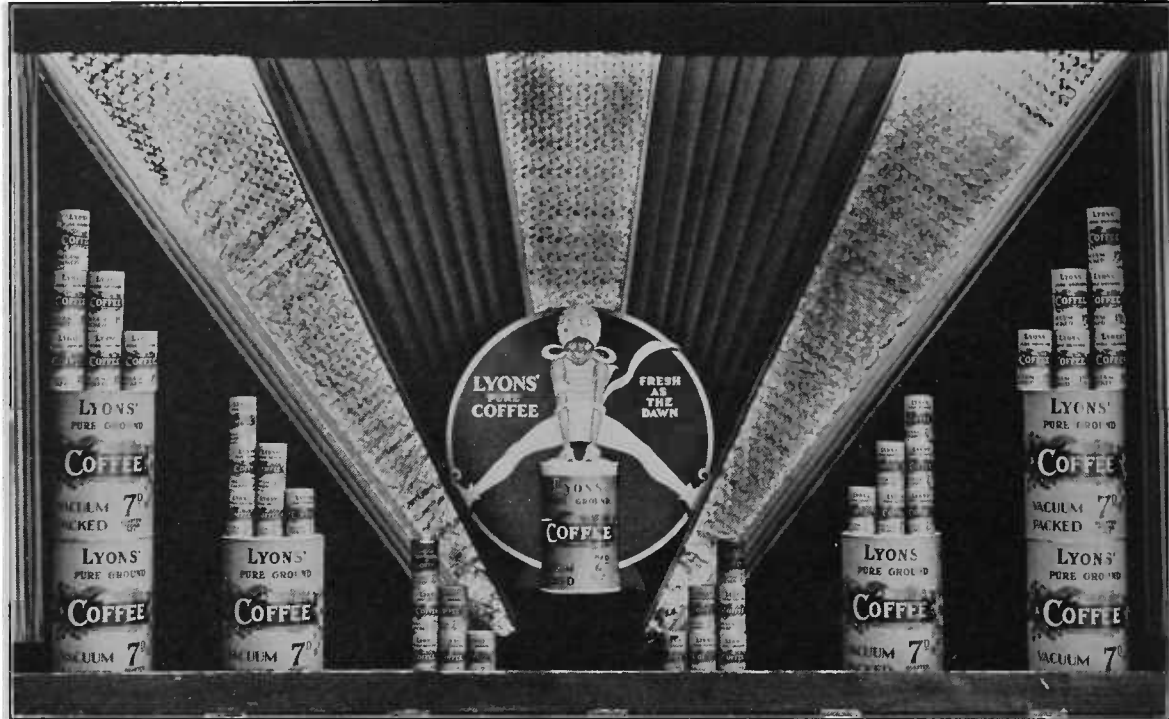
grocer's neighborhood trade. From ten to twenty-five per cent is recommended as a reasonable gross profit on coffee in most cases, although some grocers make less, and not a few make more. The independent



MASSED DISPLAY OF PACKAGE COFFEE IN AN AMERICAN SUPER MARKET

Retailers have learned that massing coffee or other products attracts special attention to them and increases sales. The above shows a segregated coffee department in a California food market. Note the display of coffee-making devices at the right, and coffee equipment in the background.





DEALERS' WINDOW DISPLAY, PROVIDED BY A BRITISH COFFEE PACKER  
 Showing how the Lyons tea and coffee firm cooperates with their dealer agents in the sale of package coffee.

dealer should meet chain-store competition in coffee on a price basis, making a special on a superior grade and figuring to get not more than three cents profit per pound, like his competitor. Under no conditions should he permit his coffee business to lag, and he must have satisfactory coffees at correct prices, which means a close margin of profit these days. A bag of roasted coffee will bring back three dollars gain, and the cash to pay for another—and the grocer has kept his customers, ninety per cent of whom, theoretically, will have bought their other food supplies from him. In recent years independent retailers have shown a tendency to demand cash on sales of all grocery items and to eliminate delivery either wholly or in part. These practices reduce the cost of operation and allow the storekeeper to reduce his prices. As a result, he has been able to meet chain-store competition. Collective buying also has been a factor in offsetting the inroads of the "chains."

One of the reasons formerly advanced for the loss of coffee trade by retail grocers was that they priced their blends in "round numbers," that is 20, 25, 30, or 40 cents; while their competitors "split nickels,"

selling their product at 18, 23, 28, or 38 cents. This is no longer true.

Most of the retail enterprises in other lines of trade built up their business on the penny-change plan; and most coffee men now agree that this should become the universal merchandising method among retail distributors of coffee.

One of the leading advocates of "splitting nickels" worked out the accompanying chart to show how coffee should be priced to make predetermined profits.<sup>5</sup>

TABLE SHOWING PROFIT PERCENTAGE ON SALES

If Your Coffee Costs	And You Sell At									
	25c.	26c.	27c.	28c.	29c.	30c.	31c.	32c.	33c.	33c.
20c.	20%	23%	26%	28%	31%	33%	35%	37%	39%	
20½c.	18%	21%	24%	26%	29%	31%	33%	35%	37%	
21c.	16%	19%	22%	25%	27%	30%	32%	34%	36%	
21½c.	14%	17%	20%	23%	25%	28%	30%	32%	34%	
22c.	12%	15%	18%	21%	24%	26%	29%	31%	33%	
22½c.	10%	13%	16%	19%	22%	25%	27%	29%	31%	
23c.	8%	11%	14%	17%	20%	23%	25%	28%	30%	
23½c.	6%	9%	13%	16%	19%	21%	24%	26%	28%	
24c.	4%	7%	11%	14%	17%	20%	22%	25%	27%	
24½c.	2%	5%	9%	12%	15%	18%	21%	23%	25%	
25c.	0%	3%	7%	10%	13%	16%	19%	21%	24%	
25½c.		2%	5%	8%	12%	15%	17%	20%	22%	
26c.		0%	3%	7%	10%	13%	16%	18%	21%	
26½c.			1%	5%	8%	11%	14%	17%	19%	
27c.				0%	3%	6%	10%	12%	15%	18%
27½c.					1%	5%	8%	11%	14%	16%
28c.						0%	3%	6%	9%	12%

<sup>5</sup> McCreery, R. W. *Tea and Coffee Trade Jour.*, (vol. xxv: no. 6: pp. 603-604).

*Figuring Costs and Profits*

According to advanced business practice the cost of doing business should be based on these fourteen points:

1. Charge interest on the net amount of the total investment at the beginning of the business year, exclusive of real estate.
2. Charge rental on real estate or buildings at a rate equal to that which would be received if renting or leasing to others.
3. Charge, in addition to what is paid for hired help, an amount equal to what the proprietor's services would be worth to others; also treat in like manner the services of any member of the family employed in the business and not on the regular payroll.
4. Charge depreciation on all goods carried over on which a less price may have to be made because of damage or any other cause.
5. Charge depreciation on buildings, tools, fixtures, or anything else suffering from age or wear and tear.
6. Charge donations and subscriptions paid.
7. Charge all fixed expenses, such as taxes, insurance, water, lights, fuel, etc.
8. Charge all incidental expenses, such as drayage, postage, office supplies, delivery, telegrams and telephones, advertising, canvassing, etc.
9. Charge losses of every character, including goods stolen, or sent out and not charged, allowances made customers, all debts, etc.
10. Charge collection expense.
11. Charge any other expense not enumerated above.
12. When it is ascertained what the sum of all the foregoing items amounts to, prove it by the books, which will give the total expense for the year; divide this figure by the total of sales, and it will show the per cent which it has cost to do business.
13. Take this per cent and deduct it from the price of any article sold, then subtract from the remainder what it cost (invoice price and freight), and the result

will show the net profit or loss on the article.

14. Go over the selling prices of the various articles and see what are profits; then put your selling figures on a profitable basis and talk it over with your competitor as well.

*Recent Trends in Retailing*

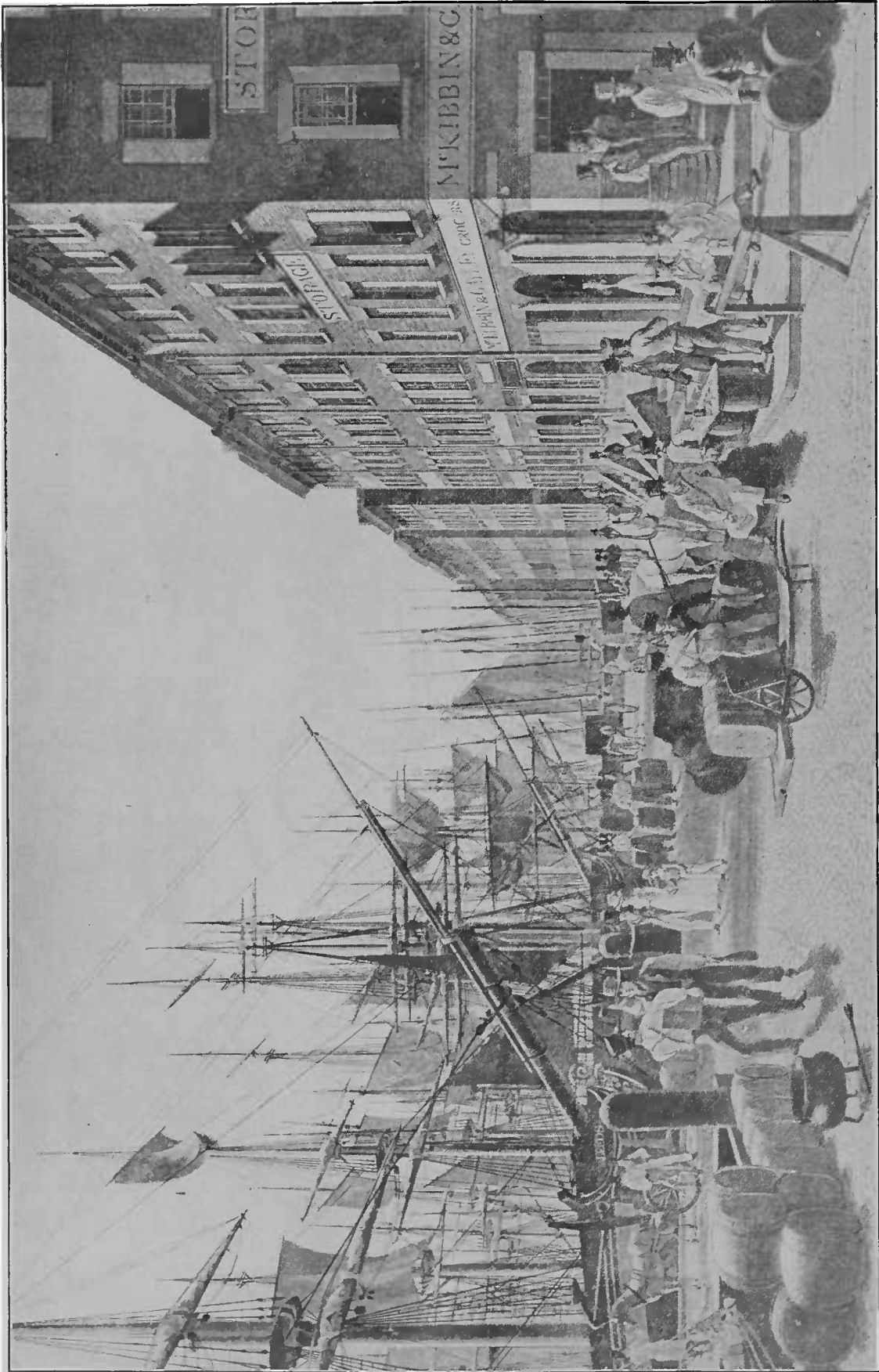
In recent years the tendency has been sharply away from the once-universal custom of extending credit to customers of retail food stores, and a survey published in 1934 disclosed that the independent cash stores had made a relatively better average showing than credit stores in maintaining their sales volume for several years. Limited credit stores, with short-term credits, well under control, made almost as good a record as cash stores. But long-time credit stores retrograded steadily, pointing to a deadly parallel between long-time credits and a decaying business. All indications point to a continuation of the trend toward short-time credits and cash in food retailing.

The same report showed that independent food stores did 50 per cent better than chain stores in maintaining their trade in 1933, a year in which the dollar-volume of all grocery sales declined. The independents lost only 3 per cent in total sales for the year while the chains lost 6 per cent. The decline in dollar volume for both chains and independents was partially accounted for by the average lower retail price level of 2.35 in 1933 as compared with 1932.

This portion of the report concluded as follows:

Several [other] factors contributed to the relatively better performance of independents than chains. Chain stores are more generally concentrated in urban communities than in rural sections. Recovery [from the depression] has been more pronounced in rural sections. As independents enjoy a larger percentage of the rural trade than chains, they naturally benefited to a greater extent, as agricultural conditions improved.<sup>6</sup>

<sup>6</sup> "Food and Grocery Facts," published by *The Progressive Grocer*, New York, January, 1934.



**THE NEW YORK DOCKS ALONG SOUTH STREET IN THE DAYS OF THE SQUARE RIGGER**  
The New York coffee trade was located then, as it is today, adjacent to these docks. From an aquatint in the Stokes Collection, New York Public Library.

## CHAPTER XXIX

### HISTORY OF THE COFFEE TRADE OF THE UNITED STATES

THE COFFEE TRADE STARTED BY DOROTHY JONES OF BOSTON—TRADE IN EARLY YEARS—CUSTOMS DUTIES—THE FIRST GROUND-COFFEE PACKAGE—THE CIVIL WAR CURTAILS TRADE—IMPORTANT INVENTIONS BY JABEZ BURNS AND JOHN ARBUCKLE—COFFEE FAILURES IN THE 'EIGHTIES—COFFEE LITIGATION—THE TRADE SINCE THE 'NINETIES—THE PURE FOOD LAW—ASSOCIATION ACTIVITIES AND OTHER RECENT EVENTS OF IMPORTANCE

IT appears from the best evidence obtainable that the coffee trade of the United States was started by a woman, Dorothy Jones, of Boston, to whom the first license to sell coffee in the colonies was issued in 1670. It is not clear whether she sold the product in the green bean, roasted, "garbled" (ground), or "ungarbled."

Soon after the introduction of the coffee drink into the New England, New York, and Pennsylvania colonies, trading began in the raw product. William Penn bought his green coffee supplies in the New York market in 1683, paying for them at the rate of \$4.68 a pound. Benjamin Franklin engaged in the retail coffee business in Philadelphia, in 1740, as a side line to his printing business.

"Tea, coffee, indigo, nutmegs, sugar etc." were advertised for sale in 1748 at a shop in Boston, "under the vendue-room in Dock-Square." Coffee was also to be had in that year at the shop of Ebenezer Lowell in King Street, and at the Sign of the Four Sugar Loaves near the head of Long Wharf.

The important part played by the coffee houses of colonial America, beginning with the establishment of the London Coffee House in Boston, in 1689, the King's Arms in New York in 1696, and Ye Coffee House in Philadelphia in 1700, has been related.

During the sway of the coffee houses, coffee fell from \$4.68 a pound to 40 cents a pound in 1750, and to 22 cents a pound just before the Revolution. As the war came on, however, dealers began to force

up prices on a dwindling market. The situation became so serious that in January, 1776, the Philadelphia Commission of Inspection issued a fair-price list, setting an arbitrary price of eleven pence per pound on coffee in bag lots. Persons found violating this price were to be "exposed to public view as sordid vultures preying on the vitals of the country."

Despite this threat J. Peters in Bethlehem, Pennsylvania, wrote to a Philadelphia friend, "I cannot purchase any coffee without taking, too, a tierce of Claret & Sour, and at £6.8 per gall. I have been trying day for day, & never could get a grain of Coffee so as to sell it at the limited price these six weeks. It may be bought, but at 25/ per lb."

In 1777, "females" of old Boston, staging a "coffee party" which rivaled in a small way the famous Tea Party in 1773, personally chastised a profiteer hoarder of foodstuffs, and confiscated some of his stock, according to a letter from Abigail Adams to her distinguished husband, later second president of the United States. Under date of July 31, of that year, she wrote:

There is a great scarcity of sugar and coffee, articles which the female part of the state is very loath to give up, especially whilst they consider the great scarcity occasioned by the merchants having secreted a large quantity. It is rumored that an eminent stingy merchant, who is a bachelor, had a hogshead of coffee in his store, which he refused to sell under 6 shillings per pound.

A number of females—some say a hundred, some say more—assembled with a cart and

trunk, marched down to the warehouse, and demanded the keys.

Upon his finding no quarter, he delivered the keys, and they then opened the warehouse, hoisted out the coffee themselves, put it into a trunk, and drove off. A large concourse of men stood amazed, silent spectators of the whole transaction.

In 1783-84 the Congress of the United States considered the imposition of a duty on "seven classes of goods consumed by the rich or in general use; liquors, sugars, teas, coffees, cocoa, molasses and pepper; the tax to be determined by the yearly imports."

At that time twelve times as much Bohea tea was being imported as of all other kinds, but tea consumption was only one-twelfth of a pound per capita. The total tea imports were 325,000 pounds. "Low as was the importation of tea," says John Bach McMaster, "that of coffee was lower still by a third. Indeed, it was scarcely used outside of the great cities." The average annual coffee imports in that period were 200,000 pounds.

Governor Bowdoin of Massachusetts introduced chicory into the United States in 1785.

The first import duty, of two and one-half cents a pound, was levied on coffee by the United States in 1789. The principal sources of supply up to that time were the Netherlands Indies, Arabia, Haiti, and Jamaica; and most of the business was in the hands of Dutch and English traders.

What is thought to have been the first wholesale coffee-roasting plant in America began operations at 4 Great Dock (now Pearl) Street, New York, early in 1790. In that same year the first American advertisement of coffee appeared in the *New York Daily Advertiser*. A second "coffee manufactory" started up at 232 Queen (also Pearl) Street, New York, late in 1790. In the same year, the government increased the import duty on coffee to four cents a pound. In 1794 the tax was raised to five cents a pound.

In George Washington's household account book for 1793 appears an entry showing a purchase of coffee from Benjamin Dorsay, a Philadelphia grocer, for eight dollars. The quantity is not given.

About 1804 Captain Joseph Ropes in the ship *Recovery*, of Salem, Mass., brought from Mocha the first cargo of coffee and other East Indian produce in an American bottom.

## Coffee Manufactory.

WHEREAS the burning and grinding of Coffee being found highly necessary in every large town in Europe for the convenience of its inhabitants, and for the supply of shipping. Seamen will not only find it exceedingly handy for their immediate use, but every part of the community, by applying to one well acquainted with that business, as it is often injured and spoiled for the want of experience or proper management, by wasteful and careless servants.— This has induced the undertaker to let it up on the European plan, with every necessary utensil at a considerable expense, so as to make it pure, good and pleasing to every unprejudiced person; and as it is the natural and prevailing motive of the human mind, to make use of every frugal method in saving their interest, by means most adapted to their own ease and satisfaction.— A few moments reflection must convince every judicious and liberal thinking person, that it can be made much better and cheaper by one making it his business to accommodate the citizen with that much consumed article on better principles than can possibly be done by families seldom having proper utensils. Although the manufacturing of coffee appears to be a very simple business, it requires a considerable deal of care & attention to burn it well, so as to make it retain its proper and genuine taste. This can be done only by burning it over a slow coal fire, making every grain of a copper colour, ridding it of all dust and chaff, so as to make it require but very little clearing; this will take five large quarters of unburnt grain, to make one pound well cleared, but it will go much farther and drink more inviting, being ground very even and light; and as the grain is chosen of the best ripe quality, it will always be superior to the rancid and green, being of a mellow and rich flavored taste, and always worth three-pence or fourpence more in the pound than the common green; this being sold at the small price of two shillings and threepence per pound, all under the half dozen weight. Allowance will be made to grocers at a distance, as it cannot fail of a ready sale. It may be had in any quantity, well packed down in narrow mouthed pots or jars of any size, so as to keep for six months, good, strong, and well flavoured, as the first hour it was put up, with care in keeping it well covered from the air.

### IN PRAISE OF COFFEE.

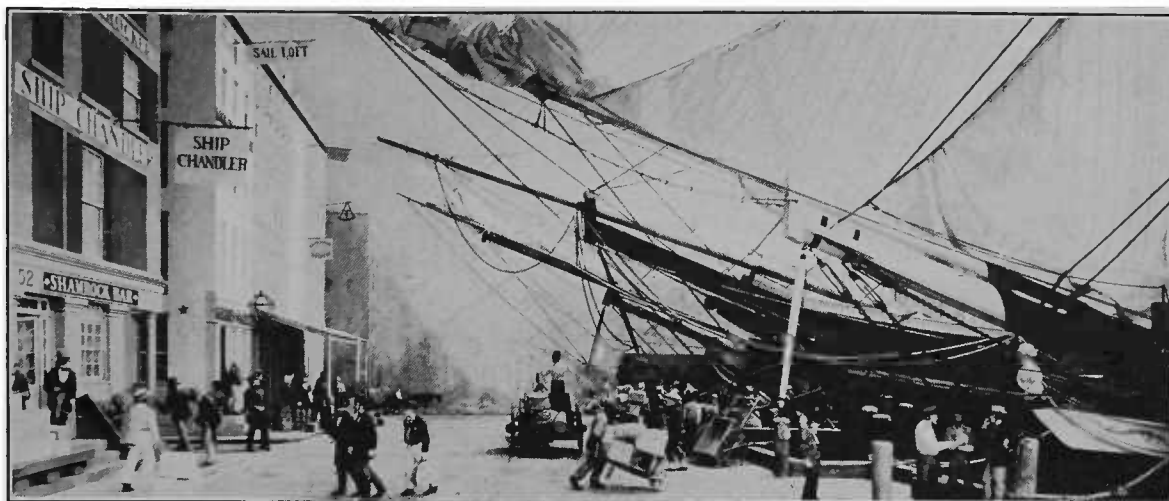
WHERE dwells the wratch, beneath what zone,  
To every elegance unknown;  
Whose soul ne'er felt the genial fire,  
That COFFEE'S subtle fumes inspire.  
When thou'rt infus'd with nicest art,  
New life to all thy streams impart,  
If Cynthia's hand the task assumes,  
Ambrosia yields to thy perfumes,  
Thy fragrant scent alone shall gain,  
Each REBEL to thy gentle REIGN.

☞ This may be always had at the FACTORY (warranted good) at No. 232, Queen Street, nearly opposite the Governor's.

New York, Dec. 21, 1790.

63





DURING THE CLIPPER SHIP ERA IN OLD NEW YORK  
South Street in the 1850's. From a miniature group by Dwight Franklin in the Museum of the City of New York.

The first cargo of Brazil coffee, consisting of 1,522 bags, was received at Salem, Mass., per ship "Marquis de Someruelas" in 1809.

Brazil's total production in 1809 was less than 30,000 bags; but by 1871 more than 2,000,000 bags were exported.

Java coffee could be bought on the Amsterdam market in 1810 for 42 to 46 cents. By 1812, there had been an advance to \$1.08 per pound. Holland ruled the world's coffee markets in those days.

#### *Customs Duties*

When the war of 1812 made necessary more revenue, imports of coffee were taxed ten cents a pound. A war-time fever of speculation in tea and coffee followed, and by 1814 prices to the consumer had advanced to such an extent—coffee was 45 cents a pound—that the citizens of Philadelphia formed a non-consumption association, each member pledging himself "not to pay more than 25 cents a pound for coffee and not to consume tea that wasn't already in the country."

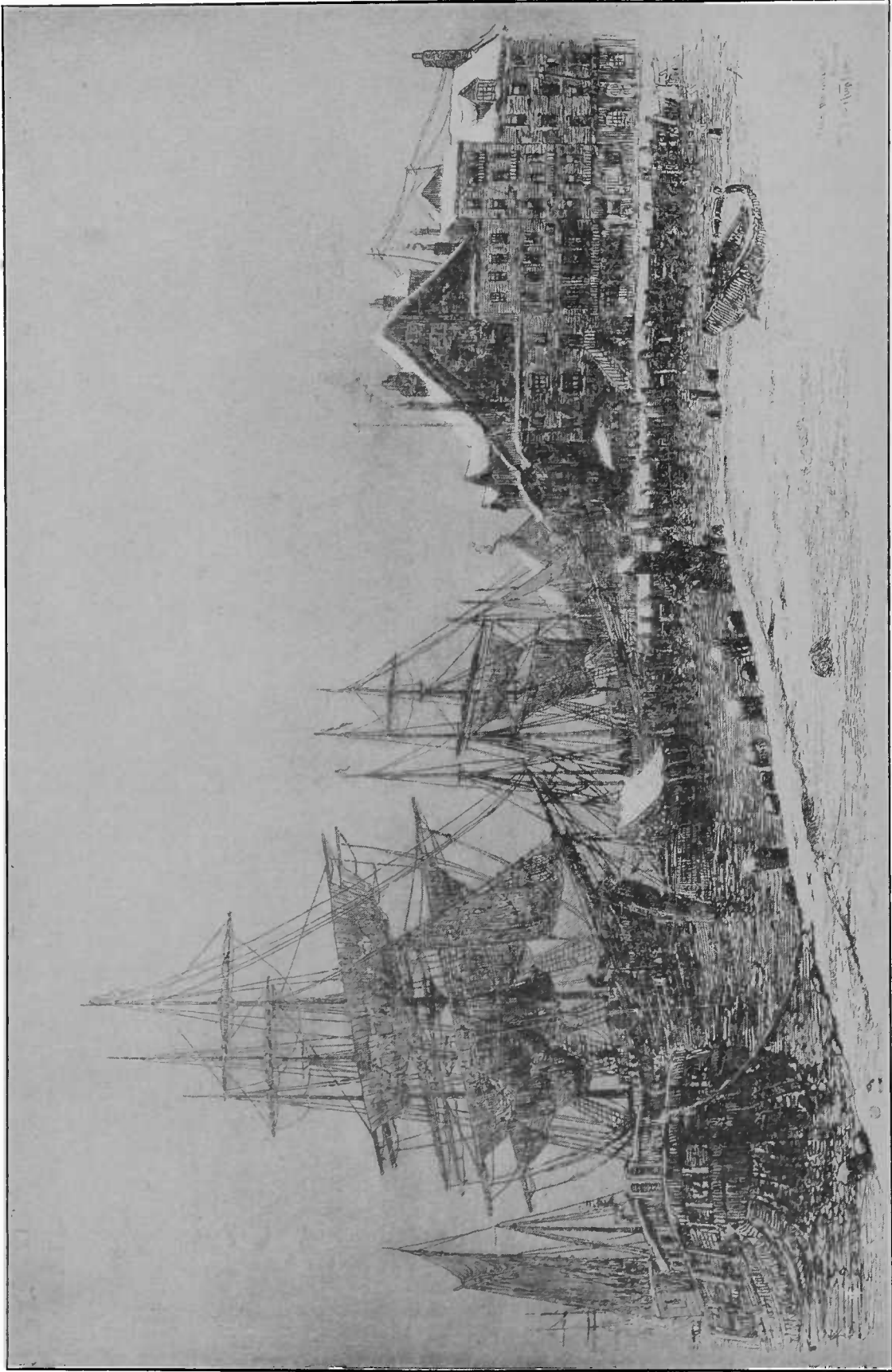
The coffee duty was reduced in 1816 to five cents a pound; in 1830, to two cents; in 1831, to one cent; and in 1832 coffee was placed on the free list. It remained there until 1861, when a duty of four cents a pound was again imposed as a war-revenue measure. This was increased to five cents in 1862. It was reduced to three cents in 1871; and the duty was repealed in 1872.

Coffee has since remained on the free list.

#### *The Trade in Early Years*

Following the American Revolution, coffee emerged from its preliminary stage as an exotic colonial luxury and became a commercial staple in the trade of the newly-born states. In this period, various firms established themselves in what has since become the tea and coffee district of New York City, to import coffee, principally from Haiti and Jamaica, which then produced over 1,000,000 bags annually, and to sell it as jobbers to the retail trade in contiguous territory. In 1795, the principal coffee importers were: Arnold & Ramsey, 53 Wall Street; D. Bethune & Co., 90 Murray's Wharf; John Brandish, 113 Water Street; Guerlain & Co., 27 Stone Street; Hall & Brasher, Pine Street Wharf; Joshua Jones, corner Front Street and Coffee House Slip; Latting & Deall, 263 Water Street; Charles P. Rogers, 115 Front Street; and John G. Warren, Swartout's Wharf.

At this time, Water and Front Streets had but recently emerged by filling-in process from the East River. Water Street was christened in 1750, but Front Street—the later water-front street—did not get its name until 1791. South Street, the third and last water-front thoroughfare to rise from the river, relegated Water and Front Streets to their present landward status. Meanwhile, a big fire, in 1804, destroyed the houses and water-front



**COENTIES SLIP, NEW YORK, IN THE DAYS OF SAILING VESSELS**

Many coffee ships from the West Indies, Arabia and the Netherlands Indies unloaded their cargoes here.—From a copper-plate etching by F. Lee Hunter.

structures on Front Street, and the new buildings that replaced them were all stores. This whole section of the city was wiped out by another big fire in 1835, so that none of the buildings now standing are more than 100 years old, although some of them, alternating with recently-built skyscrapers and tower buildings, are close to that age, and have housed many generations of tea and coffee firms.

In 1851, there were only three coffee importers in the New York tea and coffee district, according to Wakeman. They were: Henry W. Delafield, 79 Front Street; Foster, Elliott & Co., 60 South Street; and Masson & Thompson, 33 Pearl Street; while there were seventeen tea importers.<sup>1</sup>

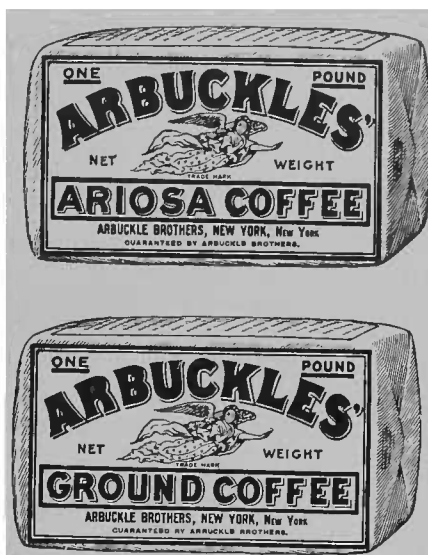
The first ground-coffee package was put on the New York market about 1860-63 by Lewis A. Osborn. It was known as "Osborn's Celebrated Prepared Java Coffee," and was later exploited by Thomas Reid as "Osborn's Old Government Java."

The first paper-bag factory in the United States to make bags for loose coffee, began operations in Brooklyn in 1862, but that year was chiefly notable for a big slump in the coffee trade attendant on the closing of ports by the Civil War. Brazil coffee sold down to 11 cents at the low point, although it advanced to 21 and 23 cents by the end of the year, and to 34 cents by June, 1863.

Following the war, the coffee trade gradually returned to normalcy, but the New York market began to feel the competition of Philadelphia, Baltimore, Charleston, Mobile, New Orleans, Savannah, and Texas ports, all importing coffee direct. Changes came quickly, however, for the Government's post-war need of increased revenues caused the placing of import duties on coffee, tea, and sugar, payable in gold. This resulted in bringing back to New York—where gold could be purchased—the supremacy as an import center.

In 1864, Jabez Burns was granted a patent on the Burns roaster which was to revolutionize the coffee-roasting business, and in 1865, John Arbuckle, of Pittsburgh, brought out his first coffee in an individual package, "like peanuts," which also was to prove revolutionary. Arbuckle's "Ariosa," the first successful national

<sup>1</sup> Wakeman, Abram. *Lower Wall Street and Vicinity*, New York, 1914.



THE ORIGINAL ARBUCKLE COFFEE PACKAGES

brand of package coffee, was launched in 1873.

The following firms were engaged in the coffee business at New York in 1878: B. G. Arnold & Co.; Hard & Rand; Sheldon, Banks & Co.; E. Wheeler & Co.; D. J. Ely & Co.; Mayer Bros. & Co.; Edwards & Maddux; Bowie Dash & Co.; Pupke & Reid; John O'Donohue's Sons; Rowland & Humphreys; Booth & Linsley; T. T. Barr & Co.; C. Risley & Co.; and Arbuckle Bros.

Until 1880-81, the leaders in the U. S. coffee trade were B. G. Arnold and Bowie Dash, of New York, and O. G. Kimball, of Boston. This trio, failing to correctly appraise the changes in facilities for doing business, such as increased production and improved distribution, found their control weakened and were obliged to fail, bringing a serious demoralization of the trade.

In order to restore confidence and re-establish an important article of commerce, the New York Coffee Exchange was incorporated in 1881 and opened for business March 7, 1882. The first president of the Exchange was Benjamin G. Arnold, but the credit for its formation goes largely to his son, Francis B. Arnold, who with James H. Taylor and Louis Seligsberg worked out the rules of the organization. The failures in 1887, 1889, and 1904 probably never would have occurred if the Exchange had enjoyed from the start a clearing system such as now exists; but that was a later creation (1917). The story of these failures is told in Chapter XXXI.

Coffee failures in the 'eighties brought an aftermath of lawsuits, and some of the decisions established precedents that remain unchanged today. A case in point, the Nevada Bank of San Francisco *vs.* Bowie Dash & Co., New York, was a test of trust receipts. The Bank alleged that between September 2 and December 1, 1880, the firm had received for account of the Bank 7,800 bags of coffee valued at \$136,000 for which they issued a trust receipt; that the firm had sold the coffee for \$123,003.17 over and above any payments made to the Bank for same; that the Bank duly demanded either payment from the firm or delivery of the coffee, but this had been refused; and that the coffee, supposedly held in trust, was disposed of by the firm in fraud of the rights of the bank and the proceeds diverted to the firm's own use. The court vacated the action, holding that a trust receipt is merely a credit given to the owner, and must be so regarded.

Another famous action was that of John O'Donohue's Sons *vs.* Francis H. Leggett & Co., New York. It seems that coffee delivered to Leggett & Co. as "Free Preanger" was actually another coffee generally accepted by the trade as such. The contract called for delivery of 1,700 piculs of Free Preanger coffee, but the tender, which Leggett & Co. refused, was for only 1,645.50 piculs. The O'Donohues sought to show that on sales of a round amount, like 1,700 piculs, even less quantities than 1,645.50 had been accepted, and that it was unusual for the exact amount named in the contract to be delivered. The lower court decided in favor of the O'Donohue firm, but on appeal the decision was reversed. The action and appeal were in the courts for five years. Contracts now read "about" the quantity named, in order to avoid this technicality.

#### *The Trade Since the 'Nineties*

Over-production of coffee became such a serious question by 1898, that J. D. Olavarria, a distinguished Venezuelan, proposed a plan for restriction of coffee cultivation, and regulation of coffee exports from countries suffering from over-production. In this same year the "bears" forced Rio 7s down to four and one-half cents on the New York Coffee Exchange.

Another revolutionary invention, destined to bring great changes to the coffee trade of the United States, was the patenting in 1898 by Edward Norton of a process for packing food products in vacuum, which was subsequently applied to coffee.

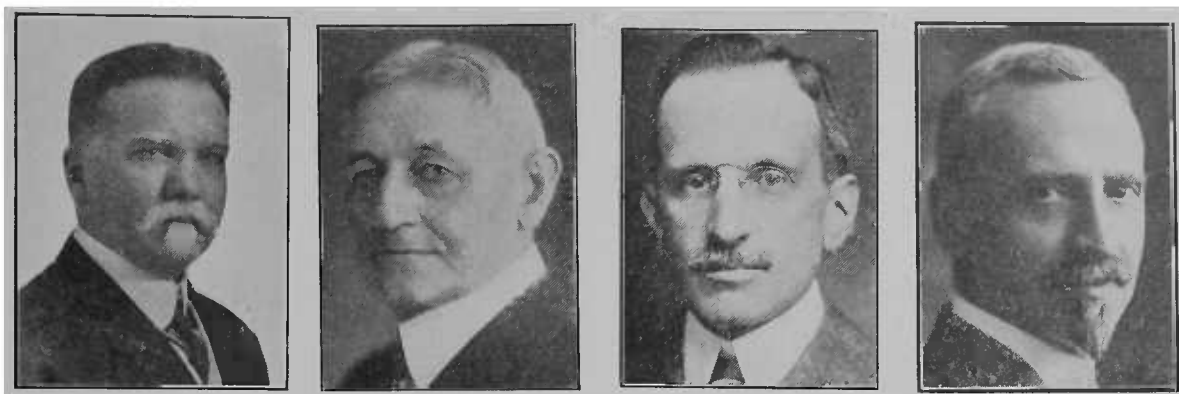
About 1899, Dr. Sartori Kato, of Tokyo, who had invented a soluble tea in Japan, came to Chicago and produced a soluble coffee, which was introduced to the consumer in 1901 and patented in 1903. In 1906, G. Washington, of New York, an American chemist living in Guatemala City, produced a refined soluble coffee, which was put on the United States market three years later. The complete story of soluble coffee is told in Chapter XXXI.

In 1901, there appeared in New York the first issue of the *Tea and Coffee Trade Journal*, devoted to the interests of the tea and coffee trades. In the same year the American Can Company began manufacturing and selling tin coffee cans in the United States. Also, in this year Landers, Frary & Clark's Universal Coffee Percolator was granted a U. S. Patent; and Joseph Lambert, of Marshall, Michigan, brought out one of the earliest machines employing gas as fuel for the indirect roasting of coffee. In 1901, also, F. T. Holmes joined the Huntley Manufacturing Company, of Silver Creek, New York, which began building the "Monitor" gas-fired, direct-flame coffee roasters.

In 1902, over-production in Brazil caused Santos 4s to drop to 3.55 cents a pound on the New York Coffee Exchange, the lowest price ever recorded for coffee. As a result of the agitation for some way to deal with over-production, the Pan-American Congress, which met in Mexico City that year, called an international coffee congress, which met in New York from October 1 to October 30, but arrived at no solution.

In 1904 the so-called "cotton crowd," headed by D. J. Sully, forced green-coffee prices up to 11.85 cents, and all records for business on the New York Coffee Exchange were smashed by the sale of 1,000,000 bags on February 5.

The A. J. Deer Company, Buffalo (later at Hornell, New York), began in 1905 the sale direct to dealers of electric coffee mills, succeeding the former practice of selling coffee mills through hardware jobbers.

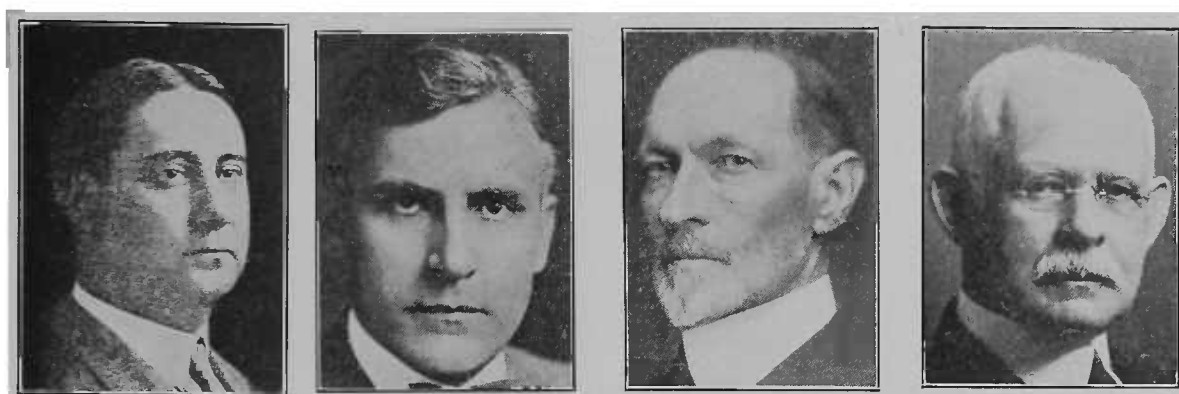


Mr. Julius J. Schotten  
1911-12

Mr. F. J. Ach  
1912-14

Mr. Ross W. Weir  
1914-16

Mr. Frank R. Seelye  
1916-17



Mr. Ben C. Casanas  
1917-18

Mr. Carl W. Brand  
1918-21

Mr. Joel O. Cheek  
1921-23

Mr. Frank O. Field  
1923-24

SOME EARLY PRESIDENTS OF THE NATIONAL COFFEE ROASTERS' ASSOCIATION

The year 1906 is memorable for the earthquake and fire which devastated San Francisco, wiping out the establishments of the tea and coffee trade with the exception of J. A. Folger & Co. The courageous manner in which the emergency was met and the trade rehoused in new and modern structures, many of which are models of their kind, is one of the brightest pages in American coffee trade history.

The first simple, fast, and accurate automatic machine for weighing coffee was patented in 1907 by Mrs. P. E. Edtbauer, giving an impetus to the packaging industry. Other patents followed in succeeding years. The event of the year which created the most stir and discussion, however, was the coming into force of the Pure Food and Drugs Act, making it obligatory to label coffee, and all other foods, truthfully. One of the earliest rulings under the Act forbade the then prevalent mislabeling of various coffees as "Mocha" and "Java," which were about the only names familiar to consumers before the ruling. This was

really "a break" for Santos and many other excellent coffees, formerly little known to consumers by their rightful names.

In 1908, Hermann Sielcken, of New York, saved Brazil's tottering coffee-valorization scheme from disaster by placing a loan of \$75,000,000 with banking houses in England, Germany, France, Belgium, and America. The story of this undertaking is told in Chapter XXXI.

Caffeine-free coffee, which for several years had been manufactured and sold in Bremen under the Myer, Roselius, and Wimmer patent was brought to America in 1909 by Ludwig Roselius; and in 1910 the product was first sold here by Merck & Company under the name of "Dekafa," later "Dekofa," and in 1914, by the Kaffee Hag Corporation as "Kaffee Hag." An event of much greater interest to the trade generally, in 1910, was a boom in coffee prices which carried Santos 4s to 13¾ cents on the New York Exchange, the highest price in twenty-three years.





Mr. Robert M. Forbes  
1924-25



Mr. Charles H. Hamilton  
1925-26



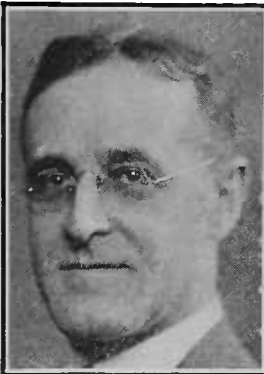
Mr. Lewis Sherman  
1926-27



Mr. Floyd E. Norwine  
1927-28



Mr. R. W. McCreery  
1928-29



Mr. R. L. Gerhart  
1929-30



Mr. Lot Boardman  
1930-32



Mr. Herbert Delafield  
1932-35

ANOTHER GROUP OF NATIONAL COFFEE ROASTERS' ASSOCIATION PRESIDENTS

Far-reaching in its effects was the organization at St. Louis, in 1911, of the National Coffee Roasters' Traffic and Pure Food Association, which resulted from preliminary meetings of Mississippi Valley coffee roasters, and was the forerunner of the later National Coffee Roasters' Association and the present Associated Coffee Industries of America.

The National Coffee Roasters' Traffic and Pure Food Association, Julius J. Schotten, St. Louis, president, held its first convention in Chicago, November 16-17, 1911, calling upon the U. S. Department of Justice to investigate coffee-market conditions, and listening to a remarkable address by Hermann Sielcken in defense of the coffee-valorization plan.

In 1912, the Department of Justice, after examining into the valorization enterprise, started suit against Hermann Sielcken, *et al.*, to force the sale of valorized coffee stocks held in this country, and Representative George W. Norris, of Nebraska,

introduced a bill in the House, at Washington, to bring coffee-valorization operations under the Interstate Commerce Law. In the same year, a delegation from the National Coffee Roasters' Traffic and Pure Food Association visited Brazil as guests of the Brazilian Government. The delegation was composed of the following: Julius J. Schotten, Carl H. Stoffregen, W. T. Jones, W. H. Harrison, Charles Lewis, John Witherspoon, Adam Kasper, and E. W. Hiscox.

Also in 1912 the Association changed its name to the National Coffee Roasters' Association. Ferdinand J. Ach, Dayton, Ohio, was elected president and a policy of scientific research was decided upon.

In 1913, the U. S. Senate passed without opposition the Norris Bill, designed to facilitate proceedings against operations in restraint of trade in coffee and other imported merchandise. Shortly thereafter the U. S. Circuit Court of Appeals dismissed the suit against Sielcken, *et al.*, be-

cause of official assurances from Brazil that the valorization coffee stored in the United States had been disposed of. The NCRA passed resolutions favoring a uniform cost and freight contract, and authorized the sending of an agent to Brazil to report on crop conditions.

The year 1914 brought the World War and its attendant evils. The New York Coffee Exchange suspended trading for several months, and the National Coffee Roasters' Association contributed a note of optimism by promoting a national "Coffee Week." Ross W. Weir was elected president of the Association.

*Merchants Coffee House Memorial*

On May 23, 1914, the Lower Wall Street Business Men's Association unveiled a bronze memorial tablet set in the wall of the nine-story office building on the southeast corner of Wall and Water Streets, the former site of the Merchants' coffee house. This is the building where *The Tea and Coffee Trade Journal* had its offices for nine years before moving to 79 Wall Street.

Seth Low, introduced by William Bayne, Jr., president of the Lower Wall Street Business Men's Association, gave an interesting sketch of the history of the coffee house. Abram Wakeman, secretary of the association, spoke, followed by Wilberforce Eames, of the American history division of the New York Public Library.

After the flag that veiled the memorial tablet had been drawn aside, attention was called to a bronze chest which was hermetically sealed, and in which had been placed papers and other documents reflecting the contemporary life of New York. The chest was given over to the keeping of the New York Historical Society, with the understanding that it was not to be opened until 1974, which will be the two-hundredth anniversary of the union of the Colonies.

*Later Activities*

A second national coffee week was held in October, 1915, under the auspices of the National Coffee Roasters' Association.

In 1916, the Coffee Exchange of the City of New York changed its name to the New York Coffee and Sugar Exchange, to admit of sugar trading. The NCRA elected Frank R. Seelye, of Chicago, president.

In 1917, the NCRA elected Benjamin C. Casanas, New Orleans, president, and the



MERCHANTS COFFEE HOUSE TABLET

Bronze marker, placed May 23, 1914, on the building occupying the site of the old coffee house.

New York Coffee and Sugar Exchange Clearing Association was incorporated to take over the clearing functions for the Exchange.

In 1918, the World War caused the United States government to place coffee importers, brokers, jobbers, roasters, and wholesalers under a war-time licensing system to control imports and prices.

At the 1918 convention of the NCRA Carl W. Brand of Cleveland was elected president and served three successive terms.

The most notable event of the year 1919 was the inauguration by the Brazil planters, in cooperation with an American Joint

Coffee Trade Publicity Committee, of a million-dollar campaign to advertise coffee in the United States.

In 1919, as a result of frost damage, and of an orgy of speculation in Brazil, prices for green coffee on the New York Exchange were forced to the highest levels since 1870; and a new high record was established for futures—24.65 cents for July contracts.

In the spring of 1920, the third national coffee week was held; this time under the auspices of the Joint Coffee Trade Publicity Committee.

In 1921, the NCRA elected Joel O. Cheek president and received a preliminary report from Prof. Samuel C. Prescott, Massachusetts Institute of Technology, on a scientific research into coffee he was conducting for the Association. Prof. Prescott said a better brew of coffee could be obtained at a temperature of 185 degrees than at the boiling point; that glass, china, or enameled-ware pots were to be preferred, and that the filtration method is superior to that employed in the pumping percolator.

In 1921 Boston received its first cargo of coffee direct from Brazil, as did also Houston, Texas.

The Green Coffee Association of New York City was organized in 1922, with William Bayne, Jr., as president. Later in the year a National Coffee Roasters' Association committee, known as the Brazil Coffee Mission and consisting of Manager Felix Coste, Webster Jones, Wallace T. Morley, and Robert Meyer, paid an official visit to Brazil. The Association elected Charles A. Clark president.

The first edition of *All About Coffee*, by William H. Ukers, was published in 1922.

In 1923, the NCRA elected Frank O. Field president and received its final report from Prof. Prescott on his coffee research, which endorsed coffee as a beverage, stating that it is a wholesome, helpful, satisfying drink for the great majority of people. In this year, also, the Brazilian Centennial Exposition awarded William H. Ukers a gold medal for his book, *All About Coffee*.

In 1924, Robert M. Forbes was elected president of the NCRA and it was proposed to organize a National Coffee Trade Council, to bring both the green-coffee men and the roasters into one guiding body to take care of problems that concern the two. The plan was approved by the green-coffee

associations of New York, San Francisco, and New Orleans. The Council consisted of the presidents of the NCRA and the three green-coffee associations, an extra member from each of the three green-coffee associations and five from the roasters, making an equal division of six green-coffee men and six roasters. The body was advisory, purely, with unanimous agreement necessary on all questions. The Council became a duly authorized body at the NCRA Convention held in 1925 at West Baden, Indiana.

An American delegation of coffee men, consisting of Felix Coste, F. J. Ach, and Berent Friele visited São Paulo in June, 1925, to study the Permanent Defense of Coffee scheme. In the same year the NCRA elected Charles H. Hamilton, New Orleans, president. Lewis Sherman succeeded to the presidency of the NCRA in 1926, and the *Tea and Coffee Trade Journal* celebrated its silver anniversary the same year.

In 1927, Floyd E. Norwine, St. Louis, was elected to the presidency of the NCRA, and the American-Brazilian Association was founded in New York to promote commercial and cultural relations between Brazil and the U. S. A.

The NCRA convention at Chicago, in 1928, elected R. Worthington McCreery, Davenport, Iowa, president, and he was re-elected, but resigned the following year, being succeeded by R. L. Gerhart, of Lancaster, Pa. Mr. Gerhart was succeeded as president by Lot Boardman, Camden, New Jersey, who was elected in 1930.

In 1931, the United States Grain Stabilization Corporation (Farm Board marketing organization) made its now historic and widely-protested exchange of 25 million bushels of wheat for 1,050,000 bags (138,600,000 lbs.) of Brazil coffee. In order to cause as little disturbance as possible, and in response to protests by the NCRA, the Grain Stabilization Board agreed to sell the exchange coffee in lots of 62,500 bags per month, which, with a few exceptions, they did. The first sale occurred on September 1, 1932, and the last on May 3, 1934. The average price obtained on all sales was slightly above 10 cents a pound.

Lot Boardman was re-elected to the presidency of the NCRA in 1931, and plans were launched for a "bigger and better" coffee trade organization to represent every U. S. coffee interest.



DELEGATION OF AMERICAN COFFEE MEN THAT VISITED BRAZIL IN 1934

Standing, left to right: Berent Friele, New York; J. M. O'Connor, New York; William H. Ukers, New York; G. M. Skinker, Denver; G. C. Thierbach, San Francisco; W. F. Williamson, New York; James S. Carson, New York; David Fromm, New York; E. G. Yonker, Washington, D. C.; W. H. Hickerson, Jr., New Orleans; Paul Nortz, New York. Seated, left to right: George G. Westfeldt, New Orleans; David Moretzsohn, Acting Consul General of Brazil at New York; Herbert Delafield, Chicago; Dr. Cyro de Freitas Valle, Minister Plenipotentiary of Brazil at Washington; Roger Holman, Omaha; D. B. Foster, Boston; R. V. McKay, Dubuque, Ia. Traver Smith, New York, and E. C. Joannes, Los Angeles, two members who sailed with the delegation, were not present when the photograph was taken at the Waldorf-Astoria, July 20, the night before sailing.

March 7, 1932, marked the fiftieth anniversary of the New York Coffee and Sugar Exchange. A jubilee dinner was held at the Waldorf-Astoria, and *The Tea and Coffee Trade Journal* got out a special Coffee Exchange Jubilee issue (March).

Preliminary steps were taken at New York in June, 1932, looking to the formation of the new national coffee trade organization along the lines suggested at the NCRA convention the preceding year. At the NCRA convention in Denver, September, 1932, the NCRA and the National Coffee Trade Council went out of existence and were succeeded by the Associated Coffee Industries of America. Mr. Herbert Delafield, of Chicago, was elected president, and has been re-elected each year since.

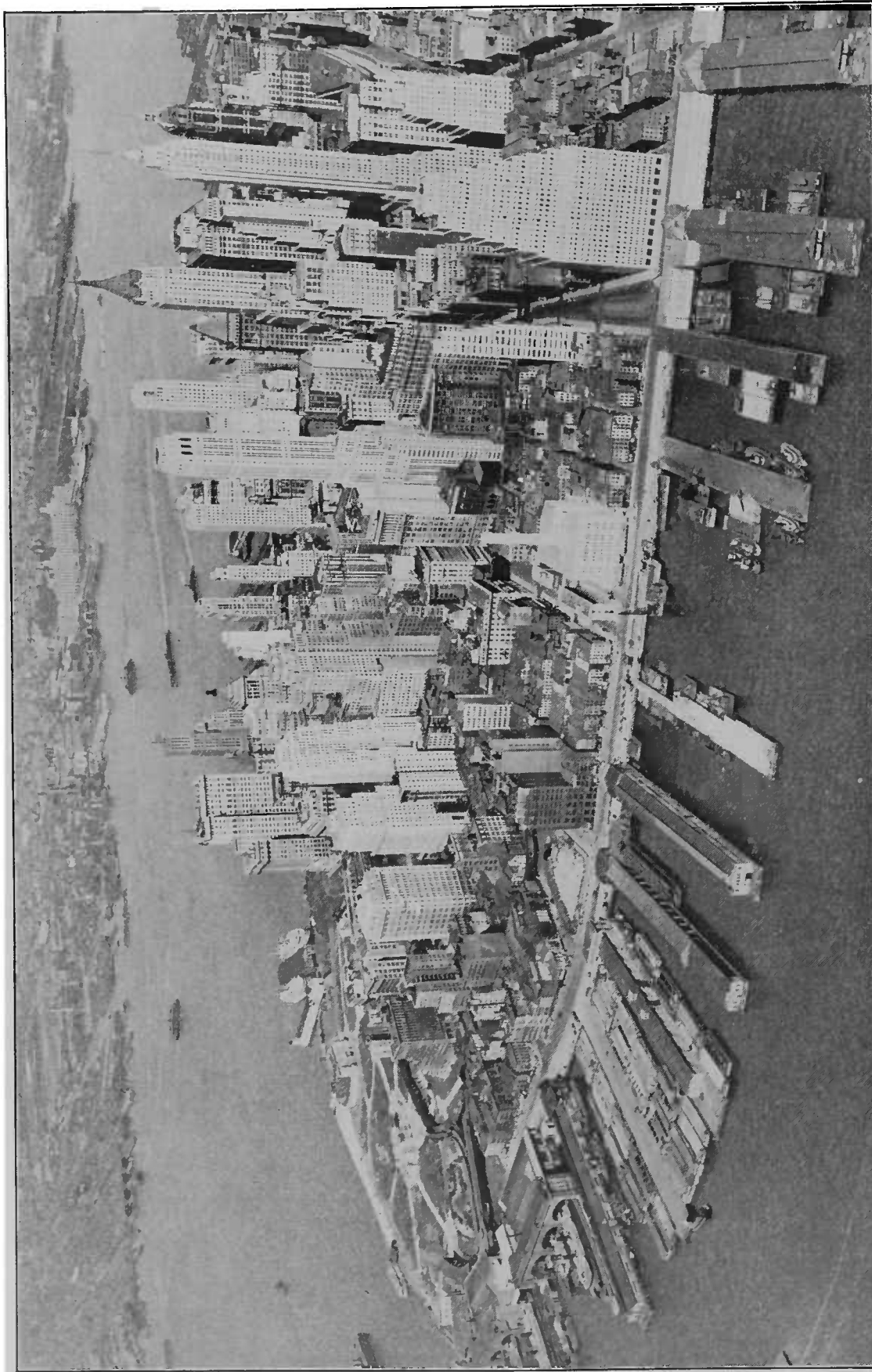
In February, 1934, the National Code Authority approved the Code of Fair Competition for the coffee trade, under the National Recovery Act (NRA). A Coffee Industries Committee of nine was selected by members of the industry to supervise

the provisions of the Code, and sixteen regional administrators were elected locally by the trade in each section. Following the decision by the U. S. Supreme Court, in 1935, that the National Recovery Act was unconstitutional, a code of fair competition was adopted by the Associated Coffee Industries of America at its annual convention.

At the invitation of the Departamento Nacional do Café, Rio de Janeiro, a delegation representing the coffee trade of the U.S.A. visited Brazil, leaving New York July 21st, 1934, and spent three weeks in the coffee districts and cities of Brazil.

The delegation was composed of the following: Herbert Delafield, William F. Williamson, Berent Friele, Traver Smith, David E. Fromm, Edward G. Yonker, James M. O'Connor, D. B. Foster, G. M. Skinker, Eugene C. Joannes, George C. Thierbach, George G. Westfeldt, William H. Hickerson, Jr., Roger P. Holman, R. V. McKay, James S. Carson and William H. Ukers.





*Fairchild Aerial Surveys, Inc.*

**AIR VIEW OF LOWER NEW YORK, WHERE THE COFFEE AND TEA DISTRICT IS LOCATED**

At the lower right (to the left of the water-front skyscraper) is Wall Street. There are many coffee firms on Front, Water, and Pearl Streets, adjacent to Wall Street. South Street runs along the water's edge.



## CHAPTER XXX

### DEVELOPMENT OF THE GREEN AND ROASTED COFFEE BUSINESS IN THE UNITED STATES

A BRIEF HISTORY OF THE GROWTH OF COFFEE TRADING—NOTABLE FIRMS AND PERSONALITIES THAT HAVE PLAYED IMPORTANT PARTS IN GREEN COFFEE IN THE PRINCIPAL COFFEE CENTERS—GREEN-COFFEE TRADE ORGANIZATIONS—GROWTH OF THE WHOLESALE COFFEE-ROASTING TRADE, AND NAMES OF THOSE WHO HAVE MADE HISTORY IN IT—STATISTICS OF DISTRIBUTION OF COFFEE-ROASTING ESTABLISHMENTS IN THE UNITED STATES

COFFEE trading in the American colonies probably had its beginnings about the middle of the seventeenth century. Tea seems to have preceded coffee as an article of merchandise. Several merchants in the New England and New York settlements imported small quantities of coffee with other foodstuffs toward the close of the seventeenth century.

The early supplies of the green bean were brought from the Dutch East Indies, Arabia, Haiti, and Jamaica. About 1787, the French opened Mauritius and Bourbon to American ships, which then began to bring back coffee and tea to the Atlantic-coast cities. Mocha coffee was being imported direct in American bottoms about 1804. Coffee from Brazil was first imported by the United States in 1809. Central America began shipping coffee to the United States in 1840. The total coffee imports in 1876 were 339,789,246 pounds, valued at \$56,788,997, and received chiefly from Brazil, Haiti, British and Netherlands Indies, the West Indies, and Mexico.

New York early became the leading green-coffee market of the country.

There were several large importing merchants in New York in 1760, nearly all of whom brought in coffee. Among them were Isaac and Nicholas Gouverneur, Robert Murray, Walter and Samuel Franklin, John and Henry Cruger, the Livingstons, the Beekmans, Lott & Low, Philip Cuyler, Anthony van Dam, Hugh and Alexander Wallace, Leonard and Anthony

Lispénard, Theophylact Bache, and William Walton.

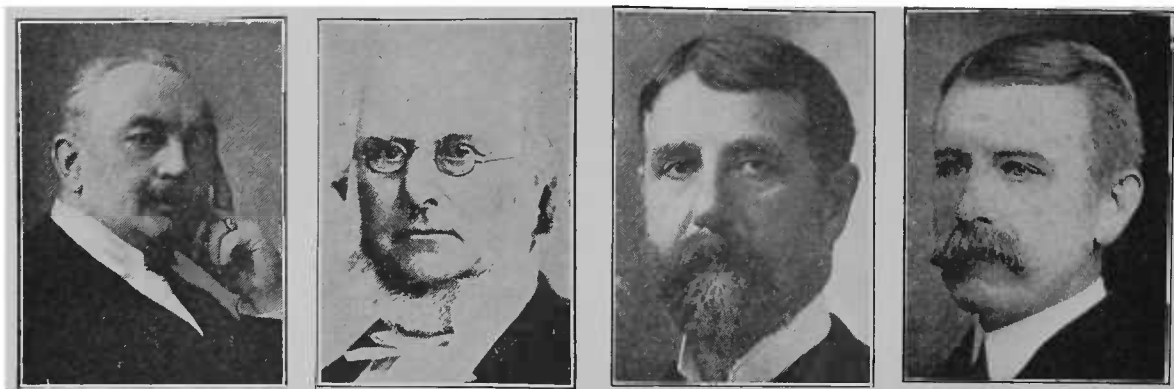
Some early green-coffee prices per pound were as follows:

1683—18s. 9d.; 1743—5s.; 1746—5s.; 1774—9s.; 1781<sup>1</sup>—96s. O. T.; 1782—2s. 1d. O. T.; 1783—1s.; 1789—10 cents.

Leading New York coffee importers in 1786 were Henry Sheaff, on the dock between Burling Slip and the Fly Market; John Rooney, 26 Cherry Street; William Eccles, 10 Hunters Key; Ludlow & Gould, 47 Wall Street; Scriba, Schroppe & Starmer, 17 Queen Street; and William Taylor, Crane Wharf.

The wholesale coffee roaster appeared about 1790; and from that time the separation between the green-coffee trader and the coffee roaster became more marked. In 1794 the principal green-coffee importers in New York were: Lawrence & Van Zandt; D. Smith & Co., 323 Pearl Street; Gilchrist Dickinson, 17 Taylor's Wharf; Armstrong & Barnewall, 129 Water Street; William Bowne, 265 Pearl Street; Stephen Cole & Son, 26 Ferry Street; J. S. De Lessert & Co., 123 Front Street; Joseph Thebaud, 262 Pearl Street; Nathaniel Cooper & Co., 38 Little Dock Street; Coll. M'Gregor, 28 Wall Street; David Wagstaff, 137 Front Street; Conkling & Lloyd, 15 Taylor's Wharf; and S. B. Garrick, Westphal & Co., 43 Cherry Street.

<sup>1</sup> About this time, the country was flooded with paper money, worth about 1 to 75, forcing the price of commodities to unheard-of heights, shoes for instance, being sold at £20 per pair.



Mr. Hermann Stielcken

Mr. B. G. Arnold

Mr. F. B. Arnold

Mr. Joseph Purcell

## SOME DEPARTED DOMINANT FIGURES IN THE NEW YORK GREEN-COFFEE TRADE

The leading New York coffee importers in 1848 were Henry and William Delafield, 108 Front Street; and Des Arts & Henser, 78 Water Street.

There were seven leading New York coffee importers in 1854, as follows: Aymar & Co., 34 South Street; Henry Coit & Son, 43 South Street; Henry Delafield, 129 Pearl Street; Howland & Aspinwall, 54 South Street; Mason & Thompson, 33 Pearl Street; J. L. Phipps & Co., 19 Cliff Street; and Moses Taylor & Co., 44 South Street.

Following the so-called "consortium" of 1868, the ramifications of which centered in Frankfort-on-the-Main—its speculations finally ending in disaster to many,—the green-coffee trade was in a precarious condition until well into the 'eighties. "Previously," says a contemporary writer, "it had been the safest and prettiest of all colonial produce."

About 1868, "iron steamers began to be freely availed of as carriers of coffee; and later on, the telegraph became a factor, rendering the business more exciting and expensive."

Coffee consumption in the United States had increased, moreover, from one pound per capita in 1790 to nine pounds per capita in 1882.

In 1892 the biggest figure in the world's coffee trade was George Kaltenbach, a German living in Paris, whose resources were estimated at twelve million to fifteen million dollars, and whose holdings at one time were said to be one million bags. He was reported to have made \$1,500,000 on his coffee corner. In September, 1892, he bested a bull clique and forced prices down to twelve cents. Aided by three other European operators, he then started a bull syndicate, and put the price up to seven-

teen cents. The story of this corner, and of other notable coffee booms and panics, is told in more detail in chapter XXXI.

*Early Days of the Green-Coffee Business*

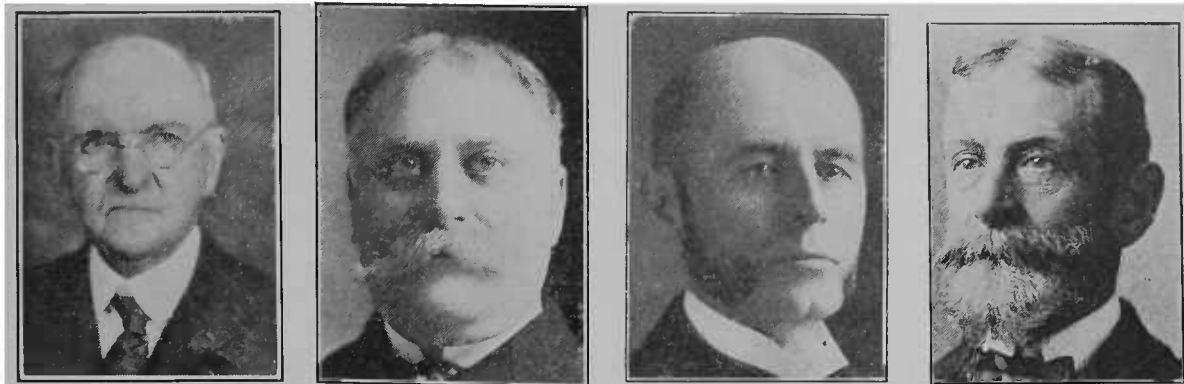
For a long time New York was the only important entry port for green coffee. Before the rise of New Orleans and San Francisco, many inland coffee roasters and grocers had their own buyers in the New York market. The coffee district that still clings about lower Wall Street is rich in memories of by-gone merchants who once were big factors in the trade, and whose names, in many instances, have been handed down from generation to generation in the businesses that have survived them.

Any reference to the early days of the green-coffee importing, jobbing, and brokerage business in New York would not be complete without mention of a few of the pioneers:

P. C. Meehan was the dean of the New York green-coffee trade at the time of his death in 1925. With James H. Briggs he formed the firm of Briggs & Meehan. This later became Meehan & Schramm, with Arnold Schramm. The latter withdrew, and the firm became Creighton, Morrison & Meehan. Finally, Mr. Meehan established the firm of P. C. Meehan & Co.

When Mr. Schramm withdrew from the firm of Meehan & Schramm he founded the house of Arnold Schramm, Inc. Upon his retirement, this was succeeded by Sprague & Rhodes, the firm being composed of Benjamin Rhodes and Irvin A. Sprague.

Clarence Creighton started with Youngs & Amman, later C. Amman & Co., then



Mr. James H. Taylor

Mr. H. Simmonds

Mr. Edwin H. Peck

Mr. P. C. Meehan

## OTHER FORMER DOMINANT FIGURES IN THE NEW YORK GREEN COFFEE TRADE

Waite, Creighton & Morrison, then Creighton, Morrison & Meehan. Upon the breaking up of this firm, Mr. Creighton formed a partnership with James Ashland, under the name of Creighton & Ashland. He later operated alone, and died August 15, 1922.

James H. Taylor was another "old-timer." He began with T. T. Barr & Co. Later, with F. T. Sherman, he formed the firm of Sherman & Taylor. When Mr. Sherman withdrew, the firm became James H. Taylor & Co. Mr. Taylor was later with Minford, Lueder & Co. He died in 1934. He was five years president, two years vice-president, nine years treasurer, and twenty-six years on the board of governors of the New York Coffee Exchange.

One of the most honored names in the green coffee trade of New York is that of Peck. Edwin H. Peck began, at the age of seventeen years, with Hart & Howell, butter and cheese merchants. He then went in the same business for himself. Four years later, he abandoned this to go into the coffee brokerage business with his brother, Walter J. Peck. In about five years, the brothers branched into the coffee importing and jobbing business under the firm name of Edwin H. Peck & Co. Later it was changed to the present style of E. H. & W. J. Peck. Walter J. Peck died in 1909 and Edwin H. Peck in 1929. The latter was a member of the board of governors of the New York Coffee Exchange for twelve years, and was an important factor in the upbuilding of that institution.

William D. Mackey began with Small Bros. & Co. He then went into partnership with C. K. Small as Mackey & Small. Later, he formed the firm of Arnold,

Mackey & Co. with Francis B. Arnold. The latter dropped out, and the firm became Mackey & Co. He died in 1931. Mr. Mackey was one of the incorporators of the New York Coffee Exchange.

Alexander H. Purcell, a brother of Joseph Purcell, entered the employ of Bowie Dash & Co. as a boy. From there he went to Williams, Russell & Co., then to the Union Coffee Co., and after to Hard & Rand. Later he headed the firm of Alex. H. Purcell & Co.

Robert C. Stewart first became known with Booth & Linsley. He later went with Joseph J. O'Donohue & Sons, leaving there to establish the firm of R. C. Stewart & Co. He died in 1933.

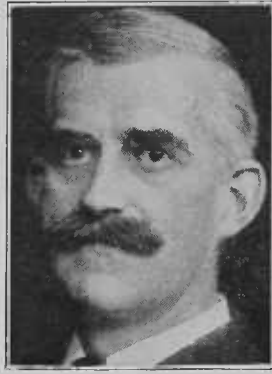
Another old-timer, Joseph D. Picksly, was a partner in the former firm of Williams, Russell & Co. He died in 1926 after fifty years in the coffee business. Frank Williams, who began with Winthrop G. Ray & Co., and James C. Russell, both of Williams, Chapin & Russell, and then of Williams, Russell & Co., also have passed on. Fred P. Gordon, now head of Fred P. Gordon & Co., was formerly with Williams, Russell & Co.

The Mitchell brothers, William L. and George, forming the firm of Mitchell Bros., have been familiar Front Street figures for many years. William L. Mitchell died in 1935.

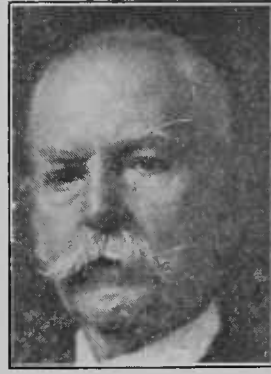
A. Wakeman, "the historian of the coffee trade," as he was sometimes called, began with Olendorf, Case & Gillespie. Later he went with Thompson & Bowers, then became a member of the firm of Baiz & Wakeman. Next he was in business alone. He died in 1928. For thirty-eight years Mr. Wakeman was secretary of the Lower Wall Street Business Men's Asso-



Mr. O. G. Kimball  
Boston



Mr. James C. Russell  
New York



Mr. James W. Phyfe  
New York



Mr. C. E. Bickford  
San Francisco

GREEN COFFEE TRADE BUILDERS WHO HAVE JOINED THE GREAT MAJORITY

ciation, and was the author of *History and Reminiscences of Lower Wall Street and Vicinity*.

H. Simmonds, of Simmonds & Bayne; later, of Simmonds & Newton; then, of the Brazil Coffee Co.; and finally, of H. Simmonds & Co., retired in 1919. He died in 1934, having been in business in Baltimore and New York for more than fifty years.

Bayne is another well known Front Street name. The firm of William Bayne & Co. was established by William Bayne, Sr., in Baltimore. The business was moved to New York about 1885. The founder's three sons, William, Jr., Daniel K., and L. P., entered the employ of the firm in Baltimore, and moved with it to New York. Daniel K. Bayne became associated with Henry Sheldon & Co., and later was a member of Simmonds & Bayne. He then returned to William Bayne & Co. and was senior partner at the time of his death in 1915. William Bayne, Jr., for many years one of the governors and a past-president and vice-president of the New York Coffee Exchange, died in 1931, and his brother, L. P. Bayne, in 1927.

Joshua Walker formed a partnership with James Stewart as Stewart & Walker. Mr. Stewart retired previous to 1922, and Mr. Walker carried on the business alone until his retirement a few years before his death, which occurred in 1930. Two other veterans of the trade were: Louis Seligsberg, formerly of Wolf & Seligsberg, who died in 1929, and Col. William P. Roome, who operated for some time as Wm. P. Roome & Co., then was head of the coffee department of Acker, Merrall & Condit Co., and died in 1925.

Gregory B. Livierato, who founded the business of Livierato Bros. at Port Said, with branches at Aden and Marseilles, and later at Hodeida and Harar, entered the green coffee trade of New York in 1855, although his L F Mocha marks had been introduced here many years before. He remained here for eighteen years, returned to his home in Cephalonia, Greece, in 1904, and died there in 1905. His nephew, B. A. Livierato, then assumed charge of the New York coffee business, which in 1913 became the Livierato-Kidde Co., with B. A. Livierato and Frank Kidde as partners. B. A. Livierato withdrew from the firm of Livierato-Kidde Co. in 1925, and resumed the business of Livierato Bros., which had been discontinued in 1913, when he went into the Livierato-Kidde partnership.

Benjamin Green Arnold, one-time "coffee king," first became well known as a member of Arnold, Sturgess & Co., afterward B. G. Arnold & Co. Mr. Arnold was one of the incorporators, and the first president, of the New York Coffee Exchange. Francis B. Arnold, with Arnold, Sturgess & Co., later of Arnold, Mackey & Co., afterward Arnold, Dorr & Co., was a son of Benjamin Greene Arnold; and to him and to Major John R. McNulty belongs a great part of the credit for the organization of the New York Coffee Exchange. Major McNulty was with Minford, Thompson & Co., and then formed the firm of J. R. McNulty & Co.

Bowie Dash, a member of the famous Arnold-Kimball-Dash triumvirate, began with Scott & Meiser, later Scott, Meiser & Co., then Scott & Dash, afterward Scott, Dash & Co., and finally Bowie Dash & Co. Other well known men with this last com-



Mr. William Bayne  
New York

Mr. George W. Crossman  
New York

Mr. George Westfeldt  
New Orleans

Mr. Wm. H. Bennett  
New York

THEIR RACE IS RUN, THEIR COURSE IS DONE

pany were L. F. Mason, A. C. Foster, S. L. Swazey, L. J. Purdy, and John B. Overton.

Then there were: Rufus G. Story; Thomas Minford, Francis Skiddy, and George J. Nevers, of Skiddy, Minford & Co.; W. D. Thompson, of Minford, Thompson & Co., later L. W. Minford & Co., afterward Minford, Lueder & Co.; Thompson, Shortridge & Co., later Thompson Bros., then Thompson & Davis; John Randall, with L. W. Minford & Co., later with J. C. Runkle & Co.; Eugene and James O'Sullivan of Eugene O'Sullivan & Co.

Steinwender, Stoffregen & Company, Inc., green coffee merchants, New York, were established in 1886. But the foundation of the business really dates back to 1876, in St. Louis, where Julius Steinwender and Charles Stoffregen formed a partnership as green coffee distributors and roasters, spice grinders, and manufacturers of extracts, etc. Mr. Julius Steinwender remained in St. Louis until 1886, when he opened the green coffee business in New York. He died in 1912. Mr. Charles Stoffregen continued in St. Louis until his death in 1930, after which the St. Louis business was discontinued. Steinwender, Stoffregen & Company, Inc., New York, operate in Colombia, South America, through a wholly owned subsidiary, Steinwender, Stoffregen Corporation, which maintains seven branches in the principal coffee growing regions of Colombia, and operates its own cleaning mills. Besides their offices in New York, Steinwender Stoffregen & Company, Inc., have a branch in New Orleans. The officers are: Carl H. Stoffregen, president; C. M. Moore and A. C. Poth, vice-presidents; B. L. Bartlett, treasurer; H. H. Snider, secretary and

assistant treasurer; John Unkles, director; and O. B. Plumly, director and manager in New Orleans.

The following names figured prominently in the trade's early history: Charles Maguire, of James H. Taylor & Co.; George F. Gilman, one of the organizers of the Great American Tea Co. and of the Great Atlantic & Pacific Tea Co.; H. W. Banks, of Reeve, Case & Banks, afterward of Stanton, Sheldon & Co., later Sheldon, Banks & Co., and then of H. W. Banks & Co.; Henry Sheldon, of Stanton, Sheldon & Co., later Sheldon, Banks & Co.; and then Henry Sheldon & Co.; William McCready, with Small Bros. & Co., later with H. W. Banks & Co., and then with B. H. Howell, Son & Co., C. R. Blakeman, with Gross, March & Co., afterward with Wm. Scott's Sons & Co.; William Scott, of William Scott & Sons, later Wm. Scott's Sons & Co., including George W. Vanderhoef, who later succeeded to the business under the name of George W. Vanderhoef & Co.; Christopher and Leander S. Risley, of C.



Mr. Julius Steinwender

Mr. Charles Stoffregen

FOUNDERS OF STEINWENDER, STOFFREGEN & Co.





AN OLD-TIME FRONT STREET PICTURE

This photograph shows a group of New York green-coffee men as they appeared nearly fifty years ago. From left to right they are: Harry Harreus, R. V. Kern, the late John J. Enright, John Unkies, and Chris Arndt.

Risley & Co.; and Charles Naphew, with C. Risley & Co., later with Edwin H. Peck & Co.

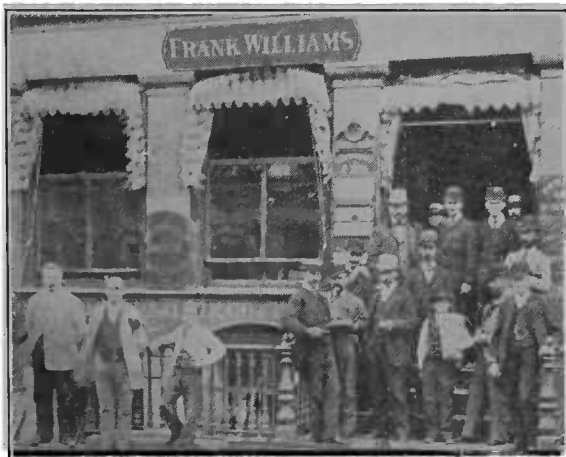
Another group of old-timers includes: William Newbold, with Ezra Wheeler & Co., later alone; Augustus Ireland, with Ezra Wheeler & Co.; J. M. Edwards, of Edwards & Maddux, later of J. M. Edwards & Co.; Frank M. Anthony, of J. M. Edwards & Co.; H. Clay Maddux, one of the incorporators of the New York Coffee Exchange, of Edwards & Maddux; Baron Thomsen, of Thomsen & Co.; Gustave Amsinck, of G. Amsinck & Co.; James N. Jarvie, with Small Bros. & Co., later of Arbuckle Bros.; John C. Lloyd, of John C. Lloyd & Co., afterward with Arbuckle Bros.; John Small, of Smalls & Bacon, later Small Bros. & Co.; Williamson Bacon, of Smalls & Bacon, afterward of Williamson Bacon & Co.; C. K. Small, of Mackey & Small, Anson Wales Hard and George Rand, of Hard & Rand; Joseph Purcell, first of W. J. Porter & Co., and then of Hard & Rand; Henry F. McCreery, with

O'Shaughnessy & Sorley, later of Hard & Rand; William Sorley and John W. O'Shaughnessy, of O'Shaughnessy & Sorley, Mr. O'Shaughnessy later forming John W. O'Shaughnessy & Co., and Mr. Sorley going to Hard & Rand. Mr. Sorley was one of the incorporators of the New York Coffee Exchange.

Special mention should be made of: Kirkland & von Sacks; A. Kirkland, one of the incorporators of the New York Coffee Exchange, with Small Bros. & Co., then with W. J. Kirkland as Kirkland Bros., and, upon the dissolution of that firm, with F. H. Leggett & Co.; Thomas Rutter & Co.; Teacle Wallace Lewis, with Rowland, Humphreys & Co., later head of the coffee department of Carter, Macy & Co., and still later, head of T. W. Lewis & Co.; Abraham Sanger, of Sanger, Beers & Fisher, later Sanger & Wells; J. W. Wilson & Co.; Dykes & Wilson; Peter John, and Joseph J. O'Donohue, of John O'Donohue's Sons; Joseph J. O'Donohue & Sons; Otis W. Booth, of Booth & Linsley; A. G. Hildreth; James H. Kirby, of B. G. Arnold & Co., later of Kirby, Halstead & Chapin, afterward Kirby & Halstead; Major Henry D. Tyler; Thomas H. Messenger & Co.; Harvey H. Palmer, of H. H. Palmer & Co.; B. O. Bowers, of Wilson & Bowers, later Thompson & Bowers; and August Haeussler, first with C. Risley & Co., then with J. H. Labaree & Co., and finally with the green coffee department of Geo. H. McFadden & Brother.

John Hanley, with Carey & Co., later of Hanley & Kinsella, St. Louis; Robert C. Hewitt, Jr., who wrote one of the early books on coffee (*Coffee, its History, Cultivation, and Uses*, 1872), of Hewitt & Phyfe, later Jas. W. Phyfe & Co.; James W. Phyfe of Hewitt & Phyfe, later Jas. W. Phyfe & Co.; Daniel A. Shaw, of Jas. W. Phyfe & Co.; B. Lahey, of Jas. W. Phyfe & Co.; and Winthrop G. Ray & Co.

These names, too, will live long in green coffee history: Reid, Murdoch & Fischer, New York and Chicago; Charles A. and Watts Miller, and David Palmer, of D. J. Ely & Co., formerly D. J. & Z. S. Ely Co., New York and Baltimore; Harry Miller, with D. J. Ely & Co., later of Miller & Walbridge; Augustus Walbridge, of Smith & Walbridge, afterward Augustus M. Walbridge, Inc.; Clarence Smith, of M. V. R. Smith's Sons, later of Smith & Walbridge; Stevens, Armstrong & Hartshorn, later



112 FRONT STREET, NEW YORK, IN 1879

A group of old-time green coffee men, including R. C. Stewart, J. D. Pickslay, Frank Williams, Charles P. Chapin, and Fred P. Gordon.

Stevens & Armstrong, then Stevens Bros. & Co., and finally Reamer, Turner & Co., including Abraham Reamer, Sr., and William F. Turner.

Other familiar old-time names were: George W. Pritchard, of George W. Pritchard & Sons; Dayton & Co.; Dimond & Lally, later Dimond & Gardes; Arthur W. Brown; Robert Russell, of Russell & Co.; J. F. Pupke and Thomas Reid, of Pupke & Reid, later Eppens, Smith & Wiemann, Eppens, Smith & Co., and Eppens Smith Co., with William H. and Frederick P. Eppens; Joseph A. O'Brien, with Pupke & Reid, and later in business for himself; R. P. McBride, of the Union Pacific Tea Co.; Ripley Ropes; Saportas Bros.; Mayer Bros. Co. of Hamburg, with Moses G. Hanauer, manager, and D. K. Young and Herman Hanauer, salesmen; H. M. Humphreys, with J. W. Doane & Co., later with Arbuckle Bros.; Henry Nordlinger, of Henry Nordlinger & Co.; Charles Campbell, of W. R. Grace & Co.; D. A. DeLima, of D. A. & J. DeLima, later D. A. DeLima & Co.; Henry Kunhardt and George F. Kuhlke, of Kunhardt & Co.; Boulton, Bliss & Dallett, later Bliss, Dallett & Co., general managers of the Red D line of steamships; Prendergast Bros.; W. H. and George W. Crossman, of W. H. Crossman & Bros., later Crossman & Sielcken, with Hermann Sielcken, afterward Sorenson & Nielson; F. Probst & Co.; H. H. Swift & Co.; J. L. Phipps & Co.; James Bennett and Joseph Becker, of Bennett & Becker; and Arnold, Hines & Co. (Diamond A Mocha), later Arnold, Cheney & Company.

Honorable mention should be accorded: Samuel Wilde (Old Dutch Mills); John Phoenix, with Husted, Ferguson & Titus, later of J. W. Phoenix & Co.; H. K. Thurber, of H. K. & F. B. Thurber & Co.; Michael Barnicle, with Walter Storm, later Storm, Smith & Co., then Abbey, Freeman & Co., then with Husted, Wetmore & Titus, and finally alone; August Stumpp, of August Stumpp & Co.; J. K. and E. B. Place; Beard & Cummings, later Beards & Cottrell, and S. S. Beard & Co.; Philip and Henry Dater, of Philip Dater & Co.; Hugh Edwards, of Edwards & Raworth; William Bennett, of Wm. Hosmer Bennett & Son; Kalman Haas, of Haas Bros.; J. C. Runkle & Co.; Thomas T. Barr and Fred T. Sherman, of Barr, Lally & Co., later T. T. Barr & Co.; Henry Hentz & Co.; Elmenhorst & Co.; A. S. Lascelles & Co.; D. Henderson (Harry) and John Wells, of Wells Bros.; G. Weyl & Co., later Norton, Weyl & Beven, and then Weyl & Norton; Warren & Co.; J. H. Labaree & Co.; Schultz & Ruckgaber; Henry Eyre; Rowland, Terry & Humphreys, later Rowland & Humphreys; Bentley, Benton & Co.; Winter & Smilie; Weston & Gray; John S. Wright, of Wright, Hard & Co., and one of the incorporators of the New York Coffee Exchange; Watjen, Toel & Co.; A. Behrens & Co.; "Steve" Matheson, of S. Matheson, Jr., & Co.; C. Wessels & Bros., later Wessels, Kulenkampff & Co., and finally Fromm & Co.; Charles Stoffregen and Julius Steinwender, of Steinwender, Stoffregen & Co.; Leon Israel, of Leon Israel & Bros.; Herklotz, Corn & Co.; Ponfold, Schuyler & Co.; Maitland, Phelps & Co., later Maitland, Coppell & Co.; F. H. Leggett, of F. H. Leggett & Co.; Carhart &



AT 87 WALL STREET, N. Y., YEARS AGO

Among the green coffee men in this picture are Clarence Creighton, John Enright, Chris Arndt, W. Lee Simmonds, John Ashlin, F. Loderose, Julius Steinwender, and Clinton Whiting.

NOTABLE FIGURES IN THE GREEN-COFFEE TRADE OF AMERICA



Mr. Daniel M. Enright  
New York



Mr. W. H. Aborn  
New York



Mr. William Bayne, Jr.  
New York



Mr. John W. Edmonds  
New York



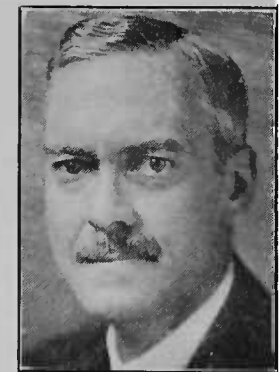
Mr. T. S. B. Nielsen  
New York



Mr. E. A. Kahl  
San Francisco



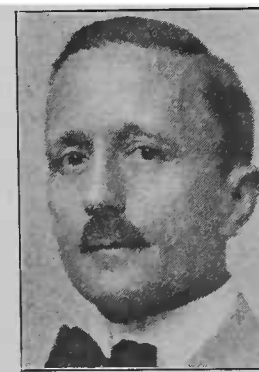
Mr. Walter F. Blake  
New York



Mr. L. D. McDowell  
Chicago



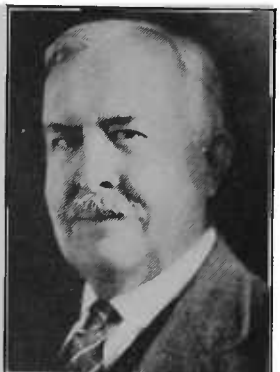
Mr. W. D. Mackey  
New York



Mr. W. R. Ruffner  
Chicago



Mr. J. D. Picketslay  
New York



Mr. Julius A. Eppens  
New York

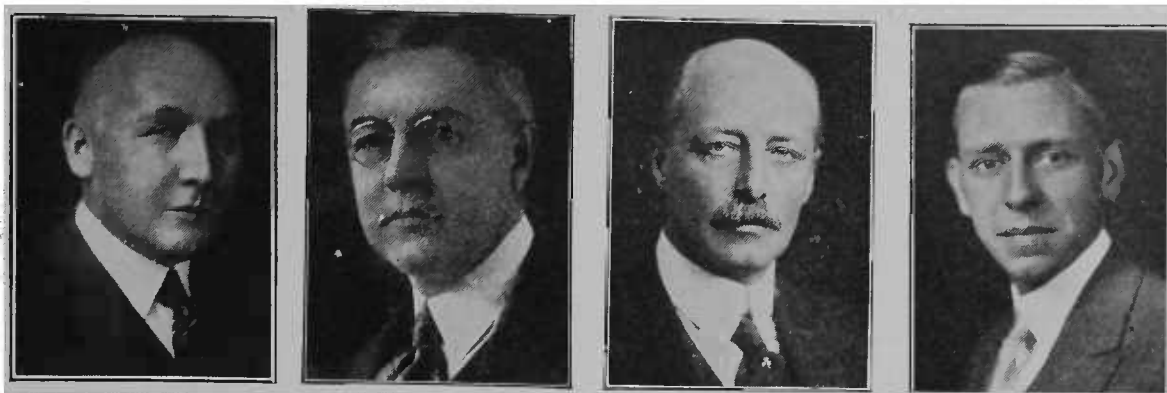
MEN WHO HELPED BUILD THE GREEN COFFEE BUSINESS OF THE UNITED STATES

The majority of those pictured in this group contributed to the more recent development of the green coffee trade in this country.

Brother; George W. Flanders, of George W. Flanders & Co.; Jonas P. O'Brien; George S. Wallen, of George S. Wallen & Co.; Charles F. Blake, of Blake & Bullard; and Martin J. Glynn, of McDonald & Glynn, later Martin J. Glynn & Co., who

had their office at Front Street and Old Slip for twenty-five years.

Three other names closely associated with the early days of the New York green-coffee trade were: Glover, Force & Co., later Waterbury & Force, then W. H.



Mr. C. H. Stoffregen    Mr. George W. Lawrence    Mr. Stephen H. Dorr    Mr. Chandler A. Mackey

NEW YORK GREEN COFFEE MEN PROMINENT IN COFFEE-EXCHANGE ACTIVITIES

Force & Co., and finally W. S. Force & Co., weighers and forwarders; Daniel Reeve, of Reeve & Van Riper, mixers and hullers; and John H. Draper & Co., auctioneers.

Thirty-five years ago, when the century opened, New York passed over her docks a total of 676,000,000 pounds of coffee, which represented eighty-six per cent of the total for the country. In 1934, she imported 745,437,000 pounds, which was forty-nine per cent of the total. While she was thus practically marking time, she watched New Orleans run wild with an increase from 44,000,000 pounds to 405,669,000 pounds, or 822 per cent gain; this meaning also the supplying of twenty-seven per cent of the country's demands instead of five per cent, while San Francisco in the same time jumped from 24,000,000 pounds to 172,584,000 pounds, or 619 per cent gain, her share of the total trade now being ten per cent instead of three per cent as in 1900. These gains, however, have not all been made at the expense of the city on the Hudson. In 1900, Baltimore was a close rival of New Orleans and was far ahead of all other ports except New York; but a decline in her imports began about 1903, and was so swift, that five years later her imports were almost negligible, but in recent years her coffee imports have been gaining again.

New Orleans began her advance at about the time that Baltimore began to fall off, so that her rise to a place of importance as a coffee port has been practically coincident with the twentieth century. Her first big step upward was in 1901, from 44,000,000 to 72,000,000 pounds, and was followed by another the next year to 115,000,000. Thereafter there was a steady gain to 213,-

000,000 pounds in 1906 and to 301,000,000 pounds in 1910, and after that wide fluctuations, especially during the war. In 1918, doubtless because of the draining of shipping to the North Atlantic service, there was a heavy slump; but immediately after the war, in the year 1919, there was a big jump to a record mark, up to that time, of 356,000,000 pounds. This was followed by 380,000,000 pounds in the year 1920, and was 405,669,000 pounds in 1934.

San Francisco's growth, on the other hand, is of recent occurrence. The story is told farther along in this chapter, how the city was definitely placed on the coffee map by the provision of adequate shipping facilities to Central America. The outbreak of the war in Europe, however, which loosened the grip of European nations on the coffee crops of Central America, was the prime cause of San Francisco's rise in the coffee world, affording her an opportunity of which she had the enterprise to take full advantage. In 1913, her imports were only about 36,000,000 pounds, at which mark they had stood for many years. There was only a slight gain until 1916, when 71,000,000 pounds were recorded; but this increased to 97,000,000 pounds in 1917, to 134,000,000 pounds in 1918 (fiscal year), and to 160,000,000 pounds in the calendar year 1919. In 1920, there was a falling off to 137,000,000 pounds, and by 1934 this had increased to 172,584,000 pounds.

*Green Coffee in New Orleans*

The history of New Orleans as a coffee port may be considered as beginning with the transfer of Louisiana by Napoleon Bon-



A SECTION OF THE GREEN COFFEE DISTRICT OF NEW ORLEANS

Most of the buildings shown here are occupied by green coffee importing houses. The one on the right with the balconies is the old Board of Trade Building.

aparte to the United States in 1803. In this year, according to Martin's *History of Louisiana*, New Orleans imported 1438 bags of coffee of 132 pounds each. In the latter part of the eighteenth century, settlers in large numbers had crossed the Allegheny Mountains from the Atlantic states into the valley of the Ohio River; and their crops of grain and provisions were exported by means of cheaply constructed rafts and boats, which were floated down the river to New Orleans, where they were generally broken up and sold for use as lumber and firewood; there being, at that time, no power available for propelling them back against the current of the river.

From 1803 until 1820, on account of the difficulty of navigating upstream, New Orleans imports did not increase as rapidly as exports. In 1814, however, the first crude steamboat began to carry freight on the river; and by 1820, the supremacy of New Orleans as the gateway of the Mississippi Valley had been established for the time by this new means of transportation. The coffee-importing business flourished; and, from its modest beginning in 1803, grew to 531,236 bags in 1857.

By this time, however, New Orleans had begun to feel the competition of the Erie Canal, and of the systems of east and west

railroad lines which had been in the course of active construction during the preceding fifteen years. The railroad systems which had as their ports Boston, New York, Philadelphia, and Baltimore, entered upon a desperate war of freight rates, each in the endeavor to establish the supremacy of its own port. As the building of railroads had been entirely east and west, and no large amount of capital had been invested in north and south lines, much of the business of the valley was diverted to the Atlantic ports, apparently never to return to New Orleans.

In 1862, on account of the blockade of the port, not a bag of coffee was imported through New Orleans, and practically none came in until the year 1866, when the small amount of 55,000 bags was the total for the year. At about this time, Boston and Philadelphia became negligible importers; the business of Baltimore continued to be quite prosperous; and New York rapidly increased her imports and took the commanding position.

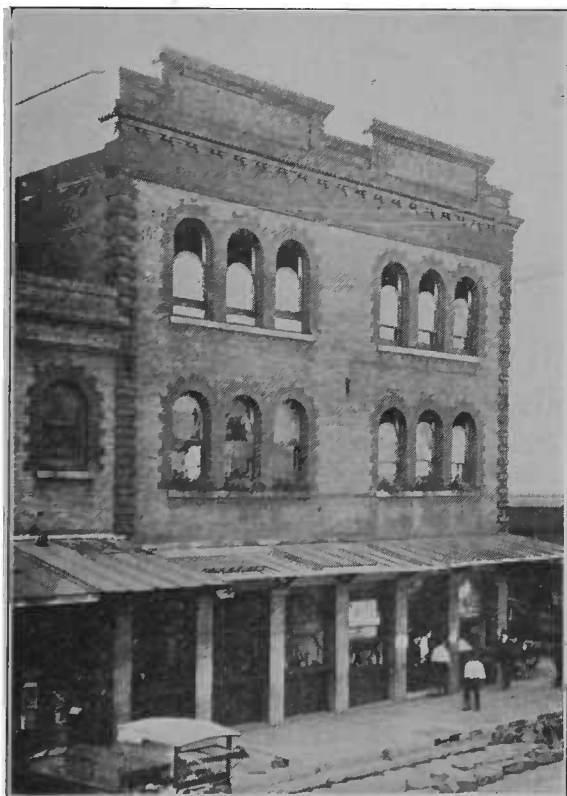
New Orleans had increased her coffee imports to 250,000 bags by 1871, and the yearly imports continued at about this figure until the last decade of the century, when the business began to expand. The imports had reached a total of 337,000 bags in 1893-



94; and of 373,000 in 1896-97. This was the beginning of a new era, and the coffee business of New Orleans entered upon the period of its greatest growth. Imports were 514,000 bags in 1900-01, and were slightly more than twice that by 1903-04. In 1909-10 the imports had again doubled, and had reached a total for the twelve months ending July 1, 1909, of slightly more than 2,000,000 bags; while the figures for the calendar year 1909 totaled 2,500,000 bags.

Borino & Bro., 77 Gravier Street, were the largest importers of coffee in New Orleans in 1869. The principal importers in 1880 were P. Poursine & Co., Westfeldt Bros., Dimond & Gardes, Schmidt & Ziegler, J. L. Phipps & Co., Geo. O. Gordon & Co., and Smith Bros.

Shipments were by sailing vessels, a full cargo being about 5,000 bags. Fancy grades, like Golden Rios, washed and peaberries, were shipped in double bags. Musty coffees were common, and every bag in a cargo was sampled for must. S. Jackson was first to issue regular manifests. With the entry of steamers into the coffee transport business, New Orleans was placed at a disadvantage as steamer rates were about



IN THE NEW ORLEANS COFFEE DISTRICT

twenty cents a bag higher to New Orleans than to New York, and imports were limited. The subsequent revival of the business was due largely to Hard & Rand. Being unable to obtain steamer rates equal to those quoted in New York, Hard & Rand chartered steamers for New Orleans; and soon the trade began to offer cost and freight to New Orleans, and the business grew from about 350,000 bags of green coffee per annum to the present figure of 3,000,000 bags.

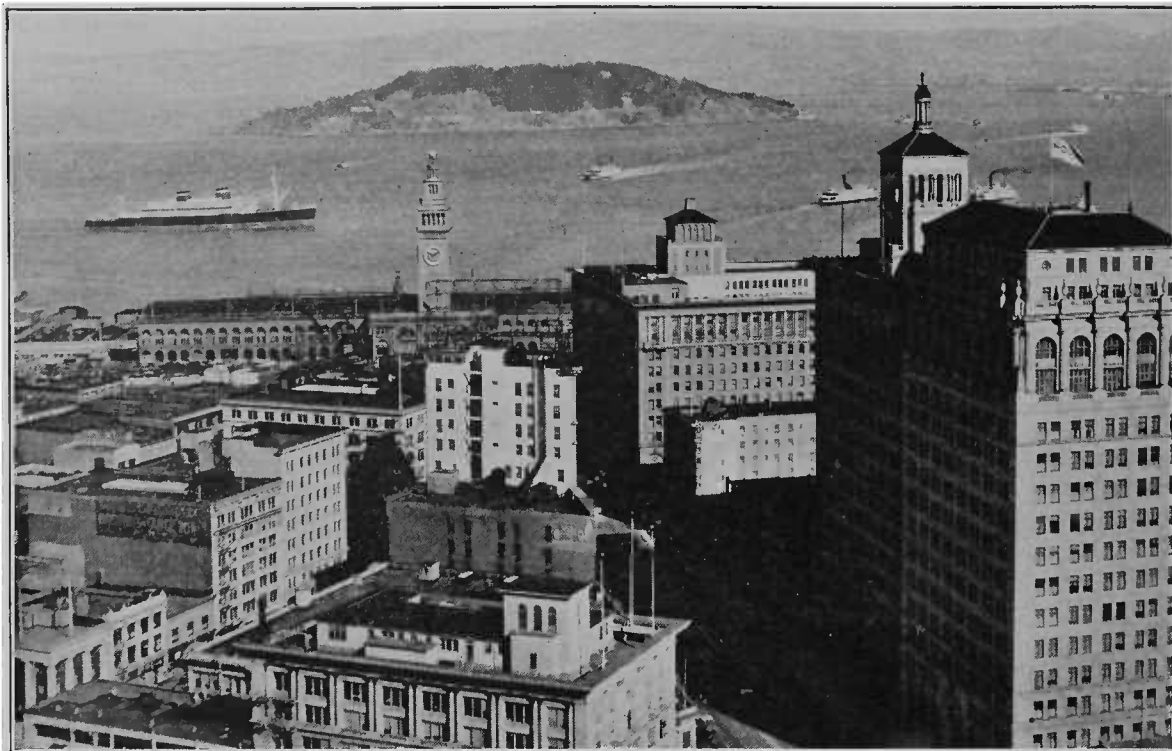
One of the best remembered names in the green coffee trade of New Orleans is that of Charles Dittmann (1848-1920), who for nearly fifty years was one of the leading coffee commission merchants of the country. Mr. Dittmann entered the coffee business with Napier & Co., representing E. Johnston & Co., of Rio de Janeiro. In 1875, upon the death of Mr. Napier, the firm changed to Johnston, Gordon & Co., later to G. O. Gordon, and in 1886 to the Charles Dittmann Co. Mr. Dittmann died in 1920, and the business was later liquidated.

#### *Green Coffee in San Francisco*

The importation of coffee into San Francisco began simultaneously with the gold discovery in California and the beginning of San Francisco. The first of the imports was sold green to hotel keepers and restaurant owners, and to private families that roasted their own coffee. Commercial roasters were installed in the 1850's.

Present-day San Francisco coffee men give the trade pioneers a large measure of credit for the prominent position of the port today. They were merchants of the highest type and laid the best sort of foundation upon which to build an enduring business.

From 1849 to 1857 no one in San Francisco seemed to specialize in coffee. In 1858 there were eight firms advertising themselves as coffee factors, featuring "chartres" coffee, among whom was W. H. Bovee & Co.'s Pioneer Mill at 125 Front Street. D. Ghirardelli, at 123 Jackson Street, bought his coffee business from L. F. Lastreto of the present Lastreto & Co. S. H. Tyler, who had been in the coffee-roasting business in Boston, went to San Francisco in the '50's and started business at 78 Davis Street. G. Vernard was at Kearney and Sacramento Streets. In 1849 M. P. Jones (father of Webster Jones of



MARKET STREET, SAN FRANCISCO, IN THE NEIGHBORHOOD OF THE COFFEE DISTRICT

The trade is located mostly on Pine and California Streets, which approach Market Street diagonally in the foreground. Part of San Francisco Bay and the cities of Berkeley, Oakland, and Alameda (left to right) are in the background.

the Jones-Thierbach Co.) went to San Francisco and in 1854 started in the wholesale grocery business. J. A. Folger began business on Front Street between California and Sacramento, next to M. P. Jones.

In the early '50's Rodolfo Hockhoffer went to San Francisco from Chile, acting as Chilean consul and afterward became the pioneer coffee, rice, and tea broker of the city. He was succeeded by C. E. Bickford.

Between 1850 and 1852 L. F. Lastreto (father of Carlos B. Lastreto) was in business with Nicholas Larco, and brought up most of the coffee from Central America on a line of small sailing vessels, touching at ports not covered by the Pacific Mail.

C. Adolphe Low & Co. started in San Francisco in 1856 and ran until 1886, when the business was transferred to E. L. G. Steele, Edward Polhemus (father of J. H. Polhemus of Hamberger-Polhemus Co.), and George Moore. In 1897, Mr. Polhemus and Mr. Steele having died, the firm changed the name to G. A. Moore & Co., who are still in the importing business.

Urruella & Urioste were established in San Francisco in the early 1870's and

operated extensively in Central American mild coffee until the early '90's, when the partners returned to Spain to live.

Cabrera, Roma & Co. started in business in San Francisco in the late 1880's and operated until 1895, when they liquidated their affairs, due to unstable conditions in Spanish countries, where they were importing and exporting.

J. T. Wright & Co. were also established in the early 1860's and carried on a large importing and exporting business with Central America, dealing extensively in coffee. The passing of the founder and his son influenced the partners owning capital in the firm to withdraw, and it ceased to operate about 17 years ago.

In 1850-60 considerable coffee came to San Francisco from Java via Hong Kong on sailing vessels, as Java coffee at that time was very popular. Later (in the '80's) coffee from the Kona district of the Hawaiian Islands was brought to San Francisco by sailing and steam vessels. It had qualities that made it a fine beverage without blending. Coffee from the Hawaiian Islands still comes to San Francisco.

All coffee in the early days had already been cleaned when it arrived in San Francisco, and from the vessels went to warehouse, importers' individual stores, or direct to auction houses. A great deal of coffee in 1850 was sold by the 30 auction houses then in business.

In early days coffee was discharged from the vessels largely by passing the bags from man to man, some of them into lighters, and from the docks was taken to warehouse or store in carts or drays the same as are still used in China.

Previous to 1870 the market for coffee in San Francisco was very small, as consumption was limited to the Pacific Coast. In 1870, on completion of the Union Pacific and Central Pacific Railroads, the markets were extended, and since then imports have steadily increased. Some time in the late 1870's or early '80's it was found necessary to ship some coffee in the hull and a number of roasters and handlers installed hulling plants, notably Jones-Paddock, Castle Bros., and J. A. Folger & Co. In the 1890's the importers of San Francisco induced the Haslett Warehouse Co. to buy out these plants, wishing a disinterested concern to do this work. The Haslett company installed one of the plants at the Gibraltar Warehouse at the north end of the city and another in the Southern Pacific Warehouse on the south side to take care of coffees landed at both sides of the city at minimum cost.

As demand arose, the public warehouses installed plants for mixing, separating, hand picking and drying, and generally caring for coffee in every way, so that now the port is without a superior in equipment for handling coffee in all respects.

The history of the ascendancy of San Francisco as a coffee-receiving port shows that for 13 years, from 1900 to 1912, the average coffee imports at San Francisco remained somewhat below 300,000 bags, but, beginning with 1913, San Francisco started to get its real coffee stride, and the increases have been progressive and extraordinary.

To climb as a market accustomed to handling 300,000 bags a year to over 1,000,000 and yet find outlets for the increase, as well as creating facilities for handling it, have been a constructive undertaking that constitutes one of the business epochs of San Francisco.

Prior to 1914 this port served only the



CALIFORNIA STREET, THE COFFEE-TRADING CENTER OF SAN FRANCISCO

small territory of states directly located on the Pacific Ocean, owing to the difficulty of obtaining supplies that could economically be brought for distribution farther than the Rocky Mountains. Geographically, San Francisco could draw coffee for this purpose only from Mexico and the four small Central American republics, and prior to 1914 the European competition encountered in those territories forced this market to content itself with a relatively unimportant position and exclusively on consignment.

The European countries, particularly Germany, had a strong grip on Central America. They had acquired a technical knowledge during their many years' experience, and their system of financing the planters, which left their product under their absolute control, precluded any serious competition from the less well-established merchants of San Francisco. German merchants and their retinues had settled in Central America, had in many instances acquired plantations, had married into some of the leading planters' families, and had thoroughly established

themselves in Central American coffee business before San Francisco merchants reached out for the industry.

Meantime exports to Central America had been growing, and San Francisco importers sent experts to Guatemala to see if something could not be done with coffee to bring the trade to a more normal balance. They soon found that the only way to do this was to meet European competition with its own methods. The native planters were loath and skeptical, however, and it was only after arduous effort, with trip after trip through the country by indomitable San Franciscans, that there was progress of importance along toward the end of 1913. This was an increase of some 100,000 bags a year which remained about stationary through the first two years of the World War.

But during all this time the San Francisco merchants had been learning the trade, and were ready to take care of the sudden jump to imports of 600,000, 870,000, 930,000, and more than 1,000,000 that followed in the next four years; thus forestalling the diversion of these shipments to New York and New Orleans. In 1934, 1,300,000 bags were imported.

A marked change in the coffee business of San Francisco was brought about by the discovery that the differences in the taste of coffees could not be accurately detected from their color or from the size of bean. To the late Clarence E. Bickford belongs the credit of having discovered the cup qualities of high-grown Central American coffees. He was employed at the time by a broker named Hockhofer, and probably did not realize what far-reaching effect his discovery would have on the future of San Francisco's coffee trade; but no other factor has contributed so much to its growth. When the roasters began to examine coffees for their taste, values were of course revolutionized. Antiguas, and other high-grown coffees, that had theretofore been penalized for the small size of bean, soon brought a premium, and have been in great demand ever since. The new classification was of material assistance to the roasters in bettering their output, as blending was put on a scientific basis.

About the middle of the nineties San Francisco began to function as a distributing center, and shipments were made from there as far east as St. Louis and Cincinnati. The selection of coffees on their cup

merit was undoubtedly a factor of considerable importance in creating new outlets. When C. E. Bickford died in 1908, the business he founded was continued by E. H. O'Brien under the name of C. E. Bickford & Co. Mr. O'Brien retired in October, 1930, and was succeeded by L. A. Wetzelberger as president of the company.

The origin of San Francisco's fight for control of Central American coffee dates back to the years 1908 to 1910, when the German Kosmos Line was fighting the Pacific Mail for the Central and South American shipping business. W. R. Grace & Co. were the heaviest shippers of American merchandise to the Latin American countries; and while their own steamers were not touching at Central American ports, they were handling merchandise from the United States and nitrates from the South American countries in their own bottoms, and were also engaged as general carriers for that trade. The fight directed by the Kosmos Line against the Pacific Mail, which at that time was under the control of the Southern Pacific Company, was accordingly directed against the Grace interests also, so far as South American countries were concerned. The fight was long, bitter, and costly to both sides. At times, the contenders offered to take freight, not only without charge, but to pay the shipper a premium for the privilege of carrying his freight.

Differences were finally settled in conference; but the experience taught the American interests that they could survive in any territory only if at all times they were able to provide their own cargoes for their own boats, as had been accomplished with nitrate in South America. J. H. Rosseter, the Grace manager, who later became well known as director of operations of the United States Shipping Board during the war, undertook an extended trip to Central America in 1912 to study the situation at close range. Coffee was the only product of Central America that was available in cargo quantities, and naturally Mr. Rosseter's attention was drawn to the possibility of carrying coffee to San Francisco to provide return cargoes for ships of the Pacific Mail, or associated lines, carrying merchandise to Central American countries.

While in Guatemala, Mr. Rosseter outlined a future policy in regard to Central American coffees; the basis being his firm

determination that coffees grown in Central America, and logically and geographically tributary to San Francisco distribution, should come to San Francisco in largely increasing quantities.

As a result of his investigation and the subsequent establishment of preferential steamer service to San Francisco, this port obtained rates which gave merchants in that city the chance to build up a steady trade, and prevented other ports in the United States from entering into serious competition with San Francisco as a distributing point for Central American coffees.

The first year open to European competition after the war showed that San Francisco was well able to maintain its lead in Central American coffees. The years of the war brought the product of virtually all plantations in Central America to the intimate knowledge of expert coffee departments; and today the advantage that Europe formerly had—of knowing exactly what a specific plantation produced—is possessed by San Francisco merchants.

This is no small advantage when we consider that in Guatemala and Costa Rica, qualities vary from plantation to plantation, and that often on adjoining plantations there is from three to five cents a pound difference in quality, from the standpoint of cup merit.

Distribution of the coffee after it has been brought to San Francisco involves many difficulties, notwithstanding that the demand is good. This will be better realized when we consider that the Pacific coast, from Alaska to Mexico, and eastward as far as the Rocky Mountains, embraces a population of about 8,000,000, whose annual consumption is estimated at 400,000 bags; and that, as already stated, treble that quantity was imported to San Francisco in 1934.

#### *Green Coffee in Various Cities*

In 1900, ninety-nine firms were engaged in the green coffee importing business (some were roasters also) in New York; six in Philadelphia; twenty-eight in San Francisco; twelve in New Orleans. In 1935, there were seventy-five in New York; thirty in San Francisco; twenty-five in New Orleans.

Among those now actively engaged in the green coffee business who have made im-

portant contributions to coffee trade history in various cities of the U. S. A. are the following:

**NEW YORK.** *Importers and jobbers*—J. Aron & Co., Balzac Bros. & Co.; J. E. Carret & Co.; Davison & Murphy; Echavarria, Inc.; W. R. Grace & Co.; Hard & Rand; Hewlett & Co.; Huth & Co.; Leon Israel & Bros., Inc.; Jones Bros. Tea Co.; S. A. Levy & Co., Inc.; J. M. Lopez & Co.; C. A. Mackey; Mecke & Co.; J. A. Medina Co.; Mitchell Bros.; E. H. & W. J. Peck; A. Rosenthal & Sons, Inc.; Russell & Co.; Schaefer Klausmann Co.; Steinwender, Stoffregen & Co.; and Taffae & Bellion. *Green coffee brokers*—Aborn & Cushman; Arnold, Dorr & Co.; W. H. Bennett & Son; C. E. Bickford & Co.; Edward Bleecker & Co.; T. Barbour Brown & Co.; Ray Deining & Co.; Fred P. Gordon & Co.; Wm. L. Korbin & Co.; Geo. W. Lawrence & Co.; P. C. Meehan & Co.; Nortz & Co.; Reamer, Turner & Co.; Sprague & Rhodes; R. C. Stewart & Co.; F. G. Varrelman & Co.; and Woods, Ehrhard & Co.

**NEW ORLEANS.** *Importers and jobbers*—J. Aron & Co.; Louis J. Bright; Goodman & Beer Co., Inc.; Hickerson Importing Co.; Stewart, Carnal & Co., Ltd.; Westfeldt Bros.; F. D. Wilcox Co.; and Zander & Co., Inc. *Green-coffee brokers*—Adolph Berkson; J. H. Edwards; F. W. Kunz Co.; A. C. Ricks & Co.; and Westfeldt Bros.

**SAN FRANCISCO.** *Importers and jobbers*—J. Aron & Co.; Balfour, Guthrie & Co.; Donald Lindo & Co.; B. J. Older & Co.; Ortega & Emigh, Inc.; Otis, McAllister & Co.; Parrott & Co.; and S. F. Pellas. *Green coffee brokers*—C. E. Bickford & Co.; C. G. Cambron; G. S. Haly Co.; and B. C. Ireland, Inc.

**BOSTON.** *Green-coffee brokers*—Philip H. Coleman; W. M. Gifford Co.; Gerard La Centra & Co.; and James D. Thumith & Co.

**PHILADELPHIA.** *Importer and jobber*—Sorver, McEvoy & Co. *Green-coffee brokers*—Granda & Rawlins and McEvoy & Smith.

**CHICAGO.** *Green-coffee brokers*—W. T. Bown & Co.; T. Barbour Brown & Co.; De Courcy Lloyd; and Teller Brokerage Co.

**ST. LOUIS.** *Green-coffee brokers*—M. S. Good & Co.; George J. Johnson; McKenna Co., Inc.; H. H. Miller & Co.; Nolte Brokerage Co.; and Schmidt & Ryan.

**KANSAS CITY.** *Green-coffee brokers*—T.



E. Leonard & Co.; Marshall & Willey; and Clark A. McCarthy.

**MILWAUKEE.** *Green-coffee brokers*—Charles L. W. Crosby; A. F. O'Brien; and R. J. Thompson.

**OTHER CITIES.** *Importer and broker*—I. A. Wood & Co., Los Angeles. *Green-coffee brokers*—John H. Blake and Smith Bros. Brokerage Co., Denver; Frank J. Ogle, Omaha; Henry van Rooy, Cleveland; and Norman Kemmler, Pittsburgh.

#### *Green Coffee Trade Organizations*

Previous to the organization of the roasters, the only kind of coffee organization in this country of more than local importance was the New York Coffee Exchange, which came into existence in 1881, the organization meeting being held in the offices of B. G. Arnold & Co., at 166 Pearl Street, New York. The Exchange was incorporated December 7, 1881, the incorporators being Benjamin Green Arnold, Francis B. Arnold, William D. Mackey, John S. Wright, William Sorley, Joseph A. O'Brien, H. Clay Maddux, C. McCulloch Beecher, Geo. W. Flanders, and John R. McNulty. B. G. Arnold was the first president. Soon afterward, rooms were rented and fitted up for trading purposes at 135 Pearl Street, at the junction of Beaver and Pearl Streets, and only two blocks away from the more pretentious structure now housing the Coffee Exchange. Actual trading operations did not begin until March 7, 1882.

The New York Coffee Exchange was the world's first coffee-trade organization of national proportions. Havre's exchange was inaugurated in 1882, under the name of the Coffee Terminal Market. Five years later, coffee exchanges were opened in Amsterdam and Hamburg; while the exchanges of London, Antwerp, and Rotterdam did not come into existence until the year 1890. The exchange in Trieste, Italy, was organized in 1905; while the Coffee Trade Association of London was started in 1916. The first exchange in Santos was started in 1914.

The success of the New York Coffee Exchange led to its imitation in other coffee ports of the United States. Baltimore started a similar organization, early in 1883, under the name of the Baltimore Coffee Exchange; but after a short existence,

it petered out. New Orleans organized a green coffee trading association in 1889, as a coffee committee of the Board of Trade. The Green Coffee Association of New Orleans, Inc., which is distinct from the Coffee Committee, was established January 7, 1920. San Francisco did not have a trading exchange until 1918, in which year the Green Coffee Association of the San Francisco Chamber of Commerce began operations.

#### *Growth of the Coffee-Roasting Trade*

The wholesale coffee-roasting business in the United States seems to have started in the closing years of the eighteenth century. In February, 1790, a "new coffee manufactory" began business at 4 Great Dock Street, New York, and the proprietor announced that he had provided himself at considerable expense with the proper utensils "to burn, grind and classify coffee on the European plan." He sold the freshly roasted product "in pots of various sizes from one to twenty weight, well packed down, either for sea or family use so as to keep good for twelve months."

A second roasting plant started at 232 Queen Street, New York, nearly opposite the governor's house, toward the close of 1790. This second coffee roasting plant was known in 1794 as the City Coffee Works. James Thompson operated a "coffee manufactory" at 25 Thames Street in 1795. In this year there was also the "Old Ground Coffee Works" in Pearl Street, formerly Hanover Square, "three doors below the bank at number 110," operating "two mills, one pair French burr stones," but no orders were accepted here for less than six pounds, at "two pence advanced from the roasting loss."

Other coffee manufactories followed in the large towns of the new states; and, always, the coffee was treated "on the European plan." This meant that it was "burnt over a slow coal fire, making every grain a copper color and ridding it of all dust and chaff." There was usually a difference in price of three to four pence a pound between the green and roasted product. Packages of roasted coffee under the half-dozen weight were sold in New York in 1791 for two shillings and three pence per pound, allowance being made for grocers at a distance. In those days, the favorite container was a narrow-mouthed pot or jar of

any size. This was the first crude coffee package. In retailing the product, cornucopias made of newspapers, or any other convenient wrapping, were first employed; but, with the introduction of paper bags in the early 'sixties, the housekeeper soon became educated to this more sanitary form of carry package, and its permanence was quickly assured.

The following were listed in Longworth's *Almanack* as coffee roasters in New York in 1805: John Applegate; Cornelius Cooper; Benjamin Cutler, 104 Division Street; George Defendorf, 83 Chapel Street; William Green; Cornelius Hassey, 14 Augustus Street; Joseph M'Ginley, 28 Moore Street; John W. Shaw, 43 Oliver Street; John Sweeney, Mulberry Street; Patience Thompson, 23 Thames Street.

Elijah Withington came from Boston to New York in 1814. He set up a coffee roaster in an alley behind the City Hall and engaged a big, raw-boned Irishman to run it. This was the beginning of a coffee roasting business that has continued until the present day. Withington dealt in Padang interiors, Jamaica, and West Indian coffees, and numbered many society folk among his customers. Withington's business removed to 7 Dutch Street in 1829; and the firm became Withington & Pine in 1830.

The roasted coffee business in New York had grown to such proportions in 1833 and gave such promise, that James Wild considered it a good investment to bring over from England complete power machinery equipment for roasting and grinding coffee. There was also an engine to run it. It was set up in Wooster Street opposite the present Washington Square.

Samuel Wilde, son of Joseph Wilde, of Dorchester, Mass., came to New York about 1840 to make his fortune. He was a young man with vision; and first applied himself with diligence to the hardware and looking-glass business. When he found that most of his customers were theaters and saloons, his religious scruples bade him abandon it, which he did.

Meanwhile, in 1844, Withington's pioneer roasting enterprise had admitted Norman Francis and Amos S. Welch as general partners, and Samuel and Charles C. Colgate as special partners, under the style of Withington, Francis & Welch. It so continued until 1848, when Samuel Wilde—who had selected the coffee business as

more honorable than the one in which he started—was admitted, and the firm became Withington & Wilde.

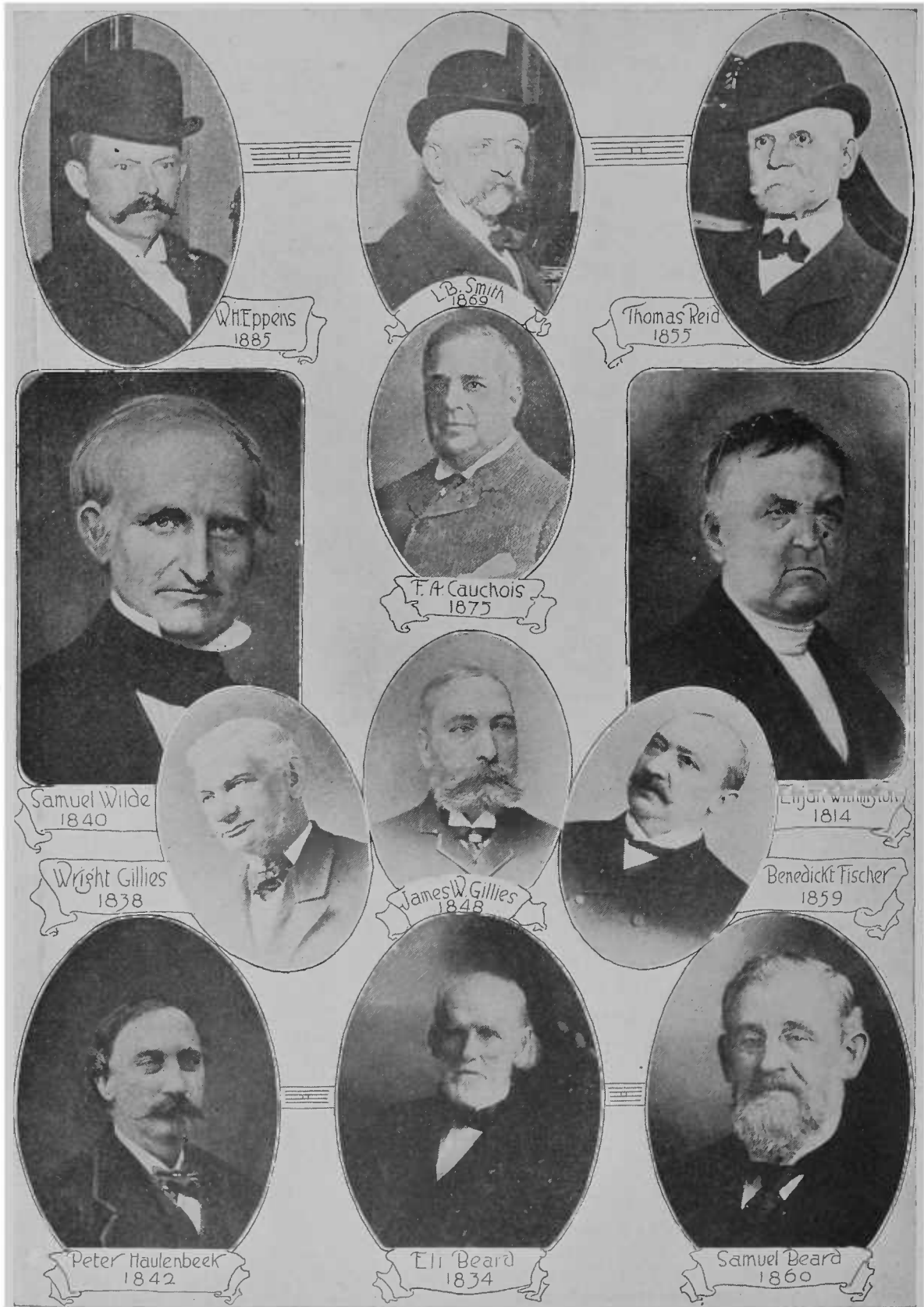
Mr. Withington retired in 1851, and Samuel Wilde associated with him in the business his sons Joseph and Samuel, Jr., the title becoming Samuel Wilde & Sons. Samuel Wilde, Sr., died in 1862. The title then became Samuel Wilde's Sons. Joseph Wilde died in 1878, and Samuel Wilde, Jr., in 1890, the business being left to and continuing with a younger brother, John, from 1878 to 1894, when John's son, Herbert W. Wilde, became a member of the firm, which continues the old title at 466 Greenwich Street, as Samuel Wilde's Sons Company, having been incorporated in 1902. John Wilde died in 1914.

Another grandson of Samuel Wilde is William B. Harris, who engaged in the coffee roasting business in Front Street from 1904 to 1917. From 1908 to 1918 he acted as coffee expert for the United States Department of Agriculture. William B. Harris is a son of Samuel L. Harris, who married a daughter of Samuel Wilde, and who for a number of years was connected with Samuel Wilde's Sons.

Although a number of roasters and grinders for family use were patented in the United States in the first half of the nineteenth century, the coffee merchants depended almost entirely on English manufacturers for their equipment until 1846, when James W. Carter of Boston introduced his "pull-out" roaster. This machine, and others like it, encouraged the development of the coffee-roasting business, so that when the Civil War came, coffee manufactories were well scattered over the country. The demand for something better in coffee-machinery equipment was answered by Jabez Burns with his machine for filling and discharging without moving the roasting cylinder from the fire.

Among the early grocery concerns in New York that were also coffee roasters were: R. C. Williams & Co., starting as Mott & Williams in 1811, changing to R. S. Williams & Co. in 1821, to Williams & Potter in 1851, and to its present title in 1882; Acker, Merrall & Condit Co., founded in 1820; Park and Tilford, founded in 1840; Austin, Nichols & Co., founded in 1855; and Francis H. Leggett & Co., founded in 1870.

There were twenty-one "coffee roasters and spice factors" in New York in 1848.



**PIONEERS IN THE ROASTED COFFEE BUSINESS OF NEW YORK CITY**

With approximate dates of their entry into the trade.

Among them were: Beard & Cummings, 281 Front Street; Henry B. Blair, 129 Washington Street; Colgate Gilbert, 93 Fulton Street; Wright Gillies, 236 Washington Street; and Withington, Wilde & Welch, 7 Dutch Street. In this year, two coffee importers, fourteen tea importers, and forty-one tea dealers were listed in the *City Directory*.

The *Directory* for 1854 listed twenty-seven coffee roasters and spice factors, among them, in addition to the above, being Peter Haulenbeek, 328 Washington Street; Levi Rowley, 102 West Street; William J. Stitt, 159 Washington Street; and George W. Wright, 79 Front Street. In those days not all the wholesale coffee factors were roasters; there was much trade roasting by a few large plants.

While the coffee-roasting business of Samuel Wilde's Sons appears to be the oldest in New York, having descended in a practically unbroken line from 1814, several others continued considerably past the half-century mark, and among them special mention should be accorded to: Levi Rowley's Star Mills, dating back to 1823; Beard & Cummings, 1834; Wright Gillies & Bro., 1840; Loudon & Son, the Metropolitan Mills, 1853; and the Eppens Smith Co., present day successors of Thomas Reid's Globe Mills of 1855.

The Star Mills in Duane Street became a real factor in the wholesale coffee-roasting business on Manhattan Island about 1823. At a later date, Levi Rowley secured control, and under his able direction the business flourished. Benedict & Gaffney bought the Star Mills from Rowley in 1885. A few years later the firm became Benedict & Thomas, then Thomas & Turner, and finally the R. G. Thomas Co. R. G. Thomas sold the equipment in 1920, ending the manufacturing end of the business just about a century from the time it started. Subsequently, Mr. Thomas was with Russell & Co. He died in 1929. Before being identified with the Star Mills, he was for twenty years with Packard & James, 123 Maiden Lane.

While still a lad of nineteen, Wright Gillies came from a Newburgh farm in 1838, and obtained a clerkship in a tea store in Chatham Street, now Chambers, and Duane Street. He branched out for himself in the tea and coffee business at 232 Washington Street in 1840, removing in 1843 to 236, which had a courtyard

where he installed a horse-power coffee roaster. The coffee business started by Wright Gillies is still conducted as the Gillies Coffee Co., by the same family and at practically the same location. James W. Gillies, a younger brother, came from Newburgh in 1848 to assist in the enterprise. Young Gillies superintended the horse-power roaster and drove the light spring delivery cart. Soon the firm became Wright Gillies & Bro. Fires visited the business in 1849 and in 1858; but each time it arose the stronger for the experience. Wright Gillies retired in 1884, and James W. Gillies assumed entire charge under the name of the Gillies Coffee Co. He continued active until his death in 1899. The business was incorporated by his children under the same name in 1906.

Edwin J. Gillies, son of James W. Gillies, started a separate coffee business at 245 Washington Street, in 1882. In 1883 he admitted as a partner James H. Schmelzel, a fellow Columbia alumnus. The enterprise was successful for many years, being incorporated under the title of Edwin J. Gillies & Co., Inc. It was consolidated in 1915 with the business of Ross W. Weir & Co., 60 Front Street. Edwin J. Gillies died in 1922, and James H. Schmelzel, in 1926.

Burns & Brown started in the coffee roasting business in 1853 in an old building at the corner of Washington and Chambers Streets for which they paid an annual rental of one thousand dollars. This was the beginning of the Metropolitan Mills, later operated by Loudon & Son, 181 Chambers Street. Burns & Brown continued for two years, when they failed, and Wright Gillies & Bro. succeeded, and put in Ebenezer Welsh as manager. Later, Wright Gillies & Co. sold out the plant to Capt. Edward C. Russell, who associated with him his son-in-law, Edward A. Phelps, Jr. At the dissolution of this partnership in 1870, the firm became Trusdell & Phelps. Mr. Phelps succeeded Trusdell, and sold out to Loudon & Stellwag in 1877. They were succeeded by Loudon & Johnson in 1879, and this firm continued until 1910, when James D. Johnson retired, and the firm of Loudon & Son took charge. These were J. Carlyle Loudon, who died in 1927, and his son, Howard C. Loudon, who died in 1911.

One of the most vigorous personalities of the sixties, and one whose influence ex-



**PIONEER COFFEE ROASTERS OF THE NORTHERN AND EASTERN UNITED STATES**

1—W. F. McLaughlin, Chicago; 2—J. G. Flint, Milwaukee; 3—Frank J. Geiger, Indianapolis; 4—Samuel Mahood, Pittsburgh; 5—Henry A. Stephens, Cleveland; 6—W. H. Harrison, Cincinnati; 7—Albert A. Sprague, Chicago; 8—D. Y. Harrison, Cincinnati; 9—William Grossman, Milwaukee; 10—Edward Canby, Dayton; 11—Thomas J. Boardman, Hartford; 12—Francis Widlar, Cleveland; 13—O. W. Pierce, Sr., Lafayette, Ind.; 14—A. M. Thomson, Chicago; 15—Samuel Young, Pittsburgh; 16—Alvin M. Woolson, Toledo; 17—Martin Hayward, Boston; 18—George C. Wright, Boston; 19—William Boardman, Hartford; 20—James S. Sanborn, Boston; 21—James Heekin, Cincinnati; 22—James F. Dwinell, Boston; 23—Caleb Chase, Boston.



tended well into this generation, was Thomas Reid. Born in Bridgeport, England, he came to the United States as a boy, and started his business career as a grocer's clerk in Brooklyn. Within three months after landing, he bought out his employer. He entered the wholesale coffee-roasting business at 105 Murray Street, New York, in 1855, in partnership with a Mr. Townsend under the style of the Globe Mills, which were the predecessors of the Eppens Smith Co. now in Warren Street. Jabez Burns, inventor of the Burns coffee roaster, before this a teamster for Henry Blair, was at one time bookkeeper for the Globe Mills. In 1864, Mr. Burns sold to the Globe Mills the first roasters of his manufacture; two one-bag, four-foot machines that were given a place alongside of four of the old-style Carter pull-outs.

Mr. Townsend died the first year of the Globe Mills' existence; and Thomas Reid continued without a partner until 1863, when he became associated with John F. Pupke, as Pupke & Reid. The business was then at 269 Washington Street. Thomas Reid was resourceful and enterprising; also he had vision. He saw the day of package coffee coming, and nearly "beat" John Arbuckle to it. As early as 1861 we find him advertising in the *City Directory*, "spices put up in every variety of package."

Lewis A. Osborn, 69 Warren Street, New York, and 81-83 South Water Street, Chicago, was advertising "Osborn's Celebrated Prepared Java Coffee—put up only by Lewis A. Osborn" in 1863-64. Thomas Reid acquired this brand and began its exploitation as "Osborn's Old Government Java," a ground package coffee, and certainly one of the earliest package coffees. However, this brand never attained the national vogue achieved by John Arbuckle's package coffee, which first appeared in 1865, although the name *Ariosa* was not given it until 1873.

Between 1855 and 1865 there were only half-a-dozen wholesale coffee roasters on Manhattan Island, and Thomas Reid was their leader. Much of his work was roasting for the trade, and this undoubtedly interfered with the logical development of his package-coffee ideas.

The firm became Pupke, Reid & Phelps in 1882. In 1885, it became Eppens-Smith Co.; later, the Eppens, Smith & Wiemann Co., and lastly, the Eppens, Smith Co.,

Inc. Thomas Reid was vice-president of the Eppens, Smith & Wiemann Co., until his death in 1902. Julius A. Eppens was president from 1914 to his death in 1935, when T. W. Dennison succeeded.

Other package coffees of the sixties were: "Government" coffee put out by Taber & Place's Rubia Mills, 353-355 Washington Street, in "tin foil pound papers," and L. Bruckmann & Co.'s "London Club," packed at 107 Warren Street.

Another old-time New York coffee-roasting business is that of Samuel S. Beard & Co. This business was founded in 1834 on Front Street by Eli Beard (father of Samuel S. Beard,) and W. A. Cummings as Beard & Cummings. In 1872, the firm moved to Duane Street, where it was joined by Messrs. S. S. Beard and Cottrell, and the new firm became Beards & Cottrell. Mr. Cottrell retired in 1883, and the firm became Samuel S. Beard & Co. Upon the death of S. S. Beard in 1905, James H. Murray, who had been with the concern for many years, became head of the house. Mr. Murray died six months later. The business moved in 1913 to 92 Front Street, where it continued as a stock company, with J. R. Westfal as manager. In 1925, the business was merged with S. A. Schonbrunn & Co., but continues to operate under its own name.

Austin C. Fitzpatrick, well known among New York coffee roasters, was a graduate of the Thomas Reid school, having entered the business of this pioneer roaster in 1865. He was western salesman for Pupke & Reid until 1871, when he became associated with Rufus G. Story under the firm name of R. G. Story & Co. Later, he formed a partnership with Howard E. Case, buying out the old house of Beard & Howell. When Mr. Case retired in 1887, the firm became A. C. Fitzpatrick & Co. This title continued for twelve years, when the Knickerbocker Mills were taken over, and the business was incorporated as the Knickerbocker Mills Co., with Mr. Fitzpatrick as president. The Knickerbocker Mills, acquired by the corporation, had been founded in 1842 and were for more than forty years at 154-156 Chambers Street. The business is now at 601 W. 26th Street. A. C. Fitzpatrick retired in 1923 and was succeeded by his son, Irving Fitzpatrick. The senior Mr. Fitzpatrick died in 1928.

Many of the pioneers in the coffee roasting business of this country were men who



**PIONEER COFFEE ROASTERS OF THE SOUTHERN AND WESTERN UNITED STATES**

1—J. B. Sinnott, New Orleans; 2—Julius J. Schotten, St. Louis; 3—Charles Stoffregen, St. Louis; 4—W. T. Jones, New Orleans; 5—J. A. Folger, Jr., San Francisco; 6—M. E. Smith, St. Louis; 7—A. E. Forbes, St. Louis; 8—David G. Evans, St. Louis; 9—W. J. Kinsella, St. Louis; 10—James H. Forbes, St. Louis; 11—J. A. Folger, Sr., San Francisco; 12—Joseph Closset, Portland, Ore.; 13—J. Zinsmeister, Louisville; 14—Wm. Schotten, St. Louis; 15—A. Schilling, San Francisco; 16—M. J. Brandenstein, San Francisco; 17—J. O. Cheek, Nashville; 18—A. H. Devers, Portland, Ore.

came from the British Isles and Germany. A notable figure from the latter country was Benedickt Fischer, who knew coffee in Germany before coming to New York in his nineteenth year. He started at 323-329 Greenwich Street, near Duane Street, in 1859. His first roaster was a primitive affair built under the E. J. Hyde patent by the Coffee Roaster & Mill Manufacturing Co. of Philadelphia. It was turned by hand by Fischer and his helper. This was about 1862. In 1864, the business required larger quarters, and was removed to the corner of Duane and Greenwich Streets. A new plant was erected at the corner of Beach and Greenwich Streets in 1894, and the present plant was erected at the corner of Franklin and Greenwich Streets in 1906. Upon the death of Benedickt Fischer in 1903, the business passed under the control of William H. Fischer, son of Benedickt, and Benedickt's son-in-law, Charles E. Diefenthaler, for many years associated with the house. At present, B. Fischer & Co., Inc., is a corporation, with G. E. Diefenthaler, president, and C. E. Diefenthaler, vice-president.

Bowie Dash, a commanding figure in the New York green coffee trade, founded the Holland Coffee Co., roasters, in 1885. He placed H. Bartow in charge. Mr. Dash himself was never active in the affairs of the company. J. Bowie Dash, son of Bowie Dash, entered the Holland Coffee Co. as a boy. Bowie Dash died in 1894. Mr. Bartow left the Holland Coffee Co. in 1897, and J. Bowie Dash became president. He sold the company in 1917 to S. B. Morrison, who consolidated it with his Esperanza Coffee Co.

George Fisher was a well known coffee roaster of the 'sixties. He began in the old Hope Mills, 71 Fulton Street, and, at the age of thirty, entered into partnership with D. C. Ripley, establishing the Hudson Mills. The firm became Sanger, Beers & Fisher in 1868; Mr. Fisher retired in 1882; and died in 1896.

Peter Haulenbeek began work as delivery boy in a grocery store. He entered the coffee business in the 'sixties in the employ of Wright Gillies, and went into the wholesale coffee-roasting trade under his own name at 170 Duane Street in 1876. His son, John W. Haulenbeek, Sr., came into his father's business in 1887. Peter Haulenbeek died January 15, 1894, and the firm name was changed to John W. Hau-

lenbeek & Co. The business remained in the same building up to 1916, when it was moved to its present location at 393 Greenwich Street. John W. Haulenbeek, Jr., of the third generation, is now active in the business.

A leading figure in the 'sixties was James Brown, who started as an engineer, rose to a partnership, and retired after the Civil War, a wealthy man. He was a partner with Thomas Reid in the old Globe Mills. He was also associated with B. Fischer in the firm of Fischer, Kirby & Brown, and established the firm of Brown & Scott in Duane Street, where Peter Haulenbeek succeeded to the business. Afterward, he continued in the firms of Brown & Jones and Bisland & Brown, and died in 1898.

Van Loan, Maguire & Gaffney was a formidable combination in the coffee-roasting business in its day. Thomas Van Loan was for thirty years a partner in the firm of W. J. Stitt & Co. (William J. Stitt was in business at 173 Washington Street in the fifties). Joseph Maguire was a practical spice grinder. Hugh Gaffney was with Brown & Scott until the firm retired in 1879, and for ten years thereafter he traveled for B. Fischer & Co. Then he became a member of the firm of Benedict & Gaffney. Ill health caused his temporary retirement; but he returned to the business in 1897 when he organized the firm of Van Loan, Maguire & Gaffney. Joseph Maguire died in 1904.

Mr. Gaffney died on March 20, 1912, and the name of the business was changed to Van Loan & Co., under which name and management it still continues at 64 North Moore Street.

O'Donohue is a well known name in the development of both the green and roasted coffee trade of New York City. John O'Donohue was a leader in the green coffee business in 1830. It was John O'Donohue's Sons in 1873. John B. O'Donohue, son of Peter O'Donohue and grandson of the original John, after leaving John O'Donohue's Sons, formed a partnership with Robert C. Stewart to engage in the green coffee jobbing business as O'Donohue & Stewart. This partnership was dissolved in 1893. For a few years, John O'Donohue was associated with the coffee-roasting firm of Wing Bros. & Hart. About 1898, he formed the O'Donohue Coffee Co. at 284 Front Street. In 1910, this was consolidated with the Potter Coffee Co. and Ben-

nett, Sloan & Co. to form the Potter, Sloan, O'Donohue Co. The firm dissolved in 1915. Ellis M. Potter came to New York from the Potter-Parlin Spice Mills in Cincinnati. Mr. O'Donohue died in 1918.

In the 'seventies Frederick Akers was proprietor of the oldest and best known trade roasting establishment in New York. The plant was known as the Atlas Mills, and was at 17 Jay Street. Mr. Akers died in 1901. The same year, William J. Morrison and Walter B. Boinest, former employees of Akers, formed a partnership to carry on the same kind of business at 413 Greenwich Street.

Col. William P. Roome, a Chesterfieldian figure among New York coffee roasters, came into the trade in 1876, when he established the firm of William P. Roome & Co., with T. L. Vickers as partner. In the Civil War that had preceded, young Roome—he was then nineteen—had distinguished himself as a conspicuous hero of the Sixth Army Corps, having entered the service as a second lieutenant in the Sixty-fifth New York Volunteers.

William P. Roome & Co. first engaged in the importation of tea, but they added coffee to the business in 1889. Col. Roome disposed of it in 1903 to assume charge of the tea and coffee department of the Acker, Merrall & Condit Company, remaining there till 1923, when he established a business of his own, packing and distributing tea balls. He died in 1925.

Frederick A. Cauchois, another picturesque figure among New York coffee roasters, entered the trade as a clerk in the New York office of Chase & Sanborn in 1875. After further tutelage under Frank Williams in the coffee brokerage business, he bought the old Fulton Mills (Colgate Gilbert & Co., 1848), in Fulton Street, where he did some of the most original advertising for coffee that the trade has seen. His Private Estate coffee in little burlap bags, his donkey train that carried the bags of green coffee through the streets of the metropolis, his system of delivering fresh, dated, coffee daily to grocers, and his Japanese paper filter device to insure the proper making of the coffee, made him famous. He brought something of the spirit of the old English coffee house to New York, and incorporated it in Keen's Chop House. He died in 1918.

The business of Russell & Co. was founded by Robert S. Russell and Frank

Smith at 107 Water Street in 1875. In 1895, S. L. Davis, formerly with Merrit & Ronaldson, became a partner. In 1900, Frank C. Russell, son of the senior member, was admitted to a partnership; and upon the death of his father in 1904, he and Mr. Davis became owners of the business. Mr. Frank C. Russell became the sole proprietor following Mr. Davis's death in 1929.

Ross W. Weir, who, in addition to being a successful New York coffee roaster, also attained prominence as president of the National Coffee Roasters Association and chairman of the Joint Coffee Trade Publicity Committee, handling the million dollar coffee advertising campaign, was born in New York in 1859, the son of J. B. Weir, one of the pioneer forty-niners, who at one time was engaged in the export commission business in San Francisco.

Mr. Weir began his business career as a general utility boy in the jobbing grocery house of S. H. Williamson, 36 Broadway, New York, in 1875. Then he was a clerk for Park & Tilford, office man with Arbuckle Bros. and with Geo. C. Chase & Co., tea importers, for two years, afterward being admitted to a junior partnership. In 1886, the firm of Ross W. Weir & Co. was formed to engage in the roasting of coffee and importing and jobbing of teas at 105 Front Street. In 1887, the business was removed to 58-60 Front Street. When the corporation of Ross W. Weir, Inc., was formed in 1915 to take over the business of E. J. Gillies & Co., Inc., Mr. Weir became president and treasurer of the combined organization. In 1929, the brands, good will, and stock on hand of Ross Weir & Co., Inc., were purchased by Arnold & Aborn. Mr. Weir died in 1932.

#### *Pioneer Wholesale Coffee Roasters*

A reference to other pioneers in the wholesale coffee-roasting trade may not be amiss here, even though it involves a repetition of some names that have been given special mention in the case of New York. In the list that follows are included the most prominent firms and the best known names that helped make roasted coffee history in the United States in the nineteenth century, particularly from 1845 to 1900:

NEW YORK. The most prominent firms in the business in New York in the 'sixties were: Thomas Reid & Co., Globe Mills; Geo. A. Merwin & Co.; Levi Rowley, Star



GROUP OF OLD-TIME NEW YORK COFFEE ROASTERS, 1892

Standing, left to right, W. H. Eppens, Fred Reid, unknown, Julius A. Eppens, Fred Eppens. Seated, left to right, John F. Pupke, Thomas Reid, Henry Mayo, Fred Akers, Alexander Kirkland.

Mills; A. B. Thorn; Fischer & Lehmann, later Fischer & Thurber, and Fischer, Kirby & Brown; Knickerbocker & Cooke; A. D. Thurber; Wm. J. Stitt & Co.; Samuel Wilde's Sons.

In the 'seventies, in addition to most of the above list, there were: Pupke & Reid; Arbuckle Bros.; Edward A. Phelps, Jr.; Bonnett, Schenck & Earle; Fischer & Lansing; J. G. Worth; Jackson & Co.; Charles Conway; Neidlinger & Schmidt; James L. Arcularius; S. M. Beard, Sons & Co.; H. K. Thurber & Co.; Wright Gillies & Bro.; Bennett & Becker; Great American Tea Co.; Brown & Scott.

Between 1876 and 1900 the following well known names appeared in the trade: Frederick Akers; Eppens-Smith Co., afterward Eppens, Smith & Wiemann Co., and later Eppens Smith Co., Inc.; B. Fischer & Co.; R. P. McBride; Fitzpatrick & Case, afterward A. C. Fitzpatrick & Co.; Great Atlantic & Pacific Tea Co.; Loudon & Johnson; Edwin Scott; Peter Haulenbeek, afterward Haulenbeek & Mitchell, and Haulenbeek Roasting & Milling Co.; Jo-

seph Stiner & Co.; Austin, Nichols & Co.; Bennett, Sloan & Co.; Gillies Coffee Co.; Benedict & Gaffney, afterward Van Loan, Maguire & Gaffney; Ross W. Weir & Co.; Union Pacific Tea Co.; Hillis Plantation Co.; Edwin J. Gillies & Co.; Jones Bros.; Holland Coffee Co.; Samuel Crooks & Co.; Benedict & Thomas.

Seeman Bros., Inc., packers of "White Rose" coffee, tea, and food products, New York, was established in 1886 by Joseph Seeman, Sigel Seeman, and George W. Doremus under the firm name of Seeman Bros. & Doremus. In 1889, the name was changed to Seeman Bros. Carl Seeman and Sylvan L. Stix were taken into the firm in 1896 and, later, in 1919, the late Frederick R. Seeman was admitted. The business was incorporated in 1921. Mr. Sigel W. Seeman died in 1931. The present officers are: Messrs. Joseph Seeman, president; Sylvan L. Stix, vice-president, sales, and advertising manager; Carl Seeman, treasurer; and Max L. Masius, secretary.

Among the present day New York roast-





Mr. Thomas J. Webb  
Chicago



Mr. George S. Wright  
Boston



Mr. Reuben W. Hills  
San Francisco



Mr. Edward Aborn  
New York

PROMINENT AMERICAN COFFEE ROASTERS WHO HAVE PASSED ON

ers, not previously mentioned, who have made important contributions to coffee-trade history are: Joseph Martinson; Old Dutch Mills; and Private Estate Coffee Company.

BOSTON. Among the pioneers in the coffee-roasting business in Boston were: N. Berry & Sons; Blanchard & Bro.; Carter, Mann & Co.; Noah Davis & Co.; Dyer & Co.; E. Emerson; Flint Bros. & Co.; J. T. & N. Glines; Hayward & Co.; Geo. W. Higgins & Co.; Hill, Dwinell & Co.; H. B. Newhall; Richardson & Lane; N. Robinson & Co.; Russell & Fessenden; Stickney & Poor; E. H. Swett; the Tremont Coffee & Spice Mills; Swain, Earle & Co.; and the Martin L. Hall Co.

Between 1876 and 1900 these names were among those added: Shapleigh Coffee Co.; Gilman L. Parker; W. S. Quimby & Co.; Thomas Wood & Co.

Dwinell & Co. and Hayward & Co. both engaged in the coffee roasting business about 1845. In 1876, they, James F. Dwinell, Martin Hayward, and his brother-in-law George C. Wright, joined hands under the name of Dwinell, Hayward & Co. In 1894, Mr. Hayward having previously retired, the name of the firm was changed to Dwinell, Wright & Co. Mr. Dwinell died in 1898; and in 1899, Mr. Wright formed a Massachusetts corporation under the present name, Dwinell-Wright Co. George C. Wright died, 1910, and his son, George S. Wright, who had been treasurer, became president. He died in 1930 at the age of 73. The third generation of descendants of Mr. George C. Wright now conduct the business. Branches are maintained in Portsmouth, Va., and Chicago.

Caleb Chase with Messrs. Carr and Ray-

mond founded the firm of Carr, Chase & Raymond at 32 Broad Street in 1864. The name was changed to Chase, Raymond & Ayer in 1871. James S. Sanborn, formerly in the coffee and spice trade at Lewiston, Me., with a branch office in Boston, combined with Caleb Chase to form Chase & Sanborn in 1878. Charles D. Sias was admitted to the firm in 1882. A Montreal office was opened in 1884. Charles E. Sanborn, son of James S., was admitted in 1888. James S. Sanborn died in 1903, and Charles E. Sanborn died two years later. Charles D. Sias died in 1913. In 1929, Chase & Sanborn became a unit of Standard Brands, Inc., of New York. Mr. Joseph Wilshire is president and Mr. Traver Smith is vice-president of Standard Brands, Inc., which also owns and distributes Fleischmann's Yeast and other well-known products.

Swain, Earle & Co. were established about 1868. In the same year, Byron T. Thayer entered the employ of the firm as a bookkeeper. He was taken into partnership in 1884, and upon the death of Mr. Earle, became managing partner. In 1915, he was the sole surviving partner of the company. He died in the latter part of 1921; and the business was absorbed by Alexander H. Bill & Co. (now Alexander H. Bill Co.) in January, 1922.

PHILADELPHIA. The following were the most prominent Philadelphia coffee roasters in 1861: Grever & Bro.; Henry Hinkle; William Johnston; George Kelly; Thornley & Ryan; Thornley & Bro.; Vankorn, Guggenheimer & Co.; D. J. Chapman; Bohler & Weikel; Charles Kroberger; and James R. Webb & Son.

Later came: Robert J. Rule & Bro.; G.

Boyd & Co.; Nutrio Mfg. Co.; C. J. Fell & Bro.; R. R. & A. Deverall; C. Thomas; William H. Cheetham, Jr.; Hill & Thornley; George Ogden & Co.; Weikel & Smith; and Alexander Sheppard, founder of Alexander Sheppard & Sons.

Between 1876 and 1900 these names appear: Henry A. Fry & Co.; Robert Smith & Sons; B. S. Janney, Jr. & Co.; and Weikel & Smith Spice Co.

Robert Smith came as a country lad to Philadelphia, and drove a wagon for Jesse Thornley, a coffee roaster. In a few years, he secured an interest in the firm; and in 1860, the name was changed to Thornley & Smith. Mr. Thornley died in 1872, and Mr. Smith bought out the Thornley interests and traded as Robert Smith until 1889. In that year, he admitted his eldest son, Robert A. Smith, into the firm, which became Robert Smith & Son. William T., another son, was admitted in 1889, the firm name being changed again to Robert Smith & Sons. Robert Smith, Sr., retired in 1902. In the same year his youngest son, George H. Smith, was admitted to the firm, and it became Robert Smith's Sons.

James R. Webb established the coffee roasting business of James R. Webb & Son in 1833. It was taken over by Alexander Sheppard in 1870. Later it became Alex. Sheppard & Sons, Inc. Mr. Sheppard died in 1916, and the business has been conducted by a corporation in which his children are the principal stockholders.

Other present-day Philadelphia roasters who have made important contributions to coffee trade history are: C. F. Bonsor & Co.; Lowry Coffee Co.; L. H. Parke & Co.; and Sorver, McEvoy & Co.

CHICAGO. Some pioneers in the Chicago trade were: Alfred H. Blackall; Excelsior Mills (Downer & Co.); Huntoon & Towner; W. F. McLaughlin; Knowles, Cloyes & Co.; Thomson & Taylor; H. F. Griswold; G. M. Hall; John L. Davies & Co.; Bell, Conrad & Webster; Sprague, Warner & Co.; Lee & Murbach; A. Stephens & Co.; and Whiting, Goeble & Co.

In the period between 1876 and 1900 the following became well known: Sprague, Warner & Griswold; Reid, Murdoch & Fischer; E. B. Millar Spice Co.; Wm. M. Hoyt Co.; Franklin MacVeagh & Co.; Sherman Bros. & Co.; H. C. & C. Durand; A. H. Pratt; McNeil & Higgins Co.; J. H. Bell & Co.; J. H. Conrad & Co.; Steele-Wedeles Co.; Krag-Reynolds Co.; Arbuckle

Bros., Puhl-Webb Co. (Thos. J. Webb Co.).

The firm of Durand-McNeil-Horner Company is a consolidation of the following firms: Henry Horner & Co., founded in 1842; Durand & Kasper Co., 1851; and McNeil-Higgins Co., 1865. These firms were merged in 1921 into the Wholesale Grocers Corporation, and in 1922 the name was changed to Durand-McNeil-Horner Company. The officers are: Maurice L. Horner, Jr., president; William R. Thele, vice-president; and Herbert Delafield, secretary and treasurer.

Samuel A. Downer founded the Excelsior Mills (Downer & Co.) in 1853. Sidney O. Blair entered the employ of the company in 1871. E. B. Millar & Co. took over the business in 1878, incorporating under that name in 1882. Mr. Blair retired in 1913, and W. S. Rice was elected president. He died in 1918, and Mr. Blair was re-elected president; with W. C. Shope, vice-president; and C. S. Mauran, secretary and treasurer.

In the spring of 1862, Albert A. Sprague came to Chicago from Vermont. With Z. B. Stetson he formed the firm of Sprague & Stetson, wholesale grocers. Mr. Stetson retired the following year, and a new partnership was formed with Ezra J. Warner, under the name of Sprague & Warner. In 1864, O. S. A. Sprague, a young brother of the senior partner was admitted to the firm, which was reorganized under its present style of Sprague, Warner & Co. About the year 1876, machinery was installed, and the roasting of coffee began. O. S. A. Sprague died in 1909, Ezra J. Warner, Sr., in 1910, and Albert A. Sprague in 1915. Frank C. Thomas is manager of the coffee department.

In 1865, A. M. Thomson, at that time a salesman for A. H. Blackall, owner of the American Mills, arranged with a Mr. Berg and a Mr. Davis to go in the coffee-roasting business with him as Berg, Thomson & Davis. After a year, however, the name became A. M. Thomson. James Thomson, a brother, came into the firm in 1868, and it was then called A. M. & James Thomson. A year later, it became A. M. Thomson again. In 1872, immediately after the fire, Mr. Taylor, a member of the firm of Whiting & Taylor, joined Mr. Thomson under the firm name of Thomson & Taylor. They continued the business under this name about ten years, until it was incorporated in 1883 under the name of Thomson &

Taylor Spice Co. Among the wholesale grocers who became stockholders at that time was W. S. Warfield, of Quincy, Ill., who, in 1901, with his son, John D. Warfield, bought most of Mr. Thomson's holdings and obtained a controlling interest. The name was changed in 1920 to Thomson & Taylor Co.

William F. McLaughlin founded the firm of W. F. McLaughlin & Co. in 1865. He died in 1905; and the business was incorporated with his son, George D., as president, and another son, Frederick, as secretary and treasurer. George D. McLaughlin was killed in an automobile accident in 1931.

The Puhl-Webb Company, founded, 1882, as a partnership by Thomas J. Webb and John Puhl, was incorporated in 1896. In 1922, the name was changed to Thomas J. Webb Company. Mr. Webb died in 1934. The business continues with Mary F. Webb, president; J. E. Carney, vice-president and treasurer; and Aplin Anderson, secretary.

Other Chicago roasters who have made important contributions to coffee trade history are: Biedermann Bros.; A. J. Kasper Co.; E. B. Millar & Co.; W. S. Quinby-Bell Conrad Co.; Steele-Wedeles Co.; and Stewart & Ashby Coffee Co.

ST. LOUIS. The following were among the pioneer coffee firms of St. Louis, dating back to the 1860-70 decade: James H. Forbes; Flint, Evans & Co.; Wm. Schotten & Co.; Fred W. Meyer; H. & J. Menown; Cavanaugh, Rearick & Co.; and Frederick A. Churchill & Co.

From 1876 to 1900 there were added: Nash, Smith & Co.; Fink & Nasse Co.; Hanley & Kinsella Coffee & Spice Co.; Flugel & Popp; C. F. Blanke Tea & Coffee Co.; Steinwender, Stoffregen & Co.; David G. Evans & Co.; and the Aroma Coffee & Spice Co.

David Nicholson established a tea and coffee business, in St. Louis, under the name of the Franklin Tea Warehouse in 1853. A year later, James H. Forbes, born in Kinross, Scotland, bought out Nicholson. In 1857, A. E. Forbes, his son, came into the store after school hours, and was admitted to partnership in 1870. Robert M. Forbes, younger son of James H. Forbes, joined the firm in 1878, and the name of the business was changed to its present style, James H. Forbes Tea and Coffee Company. The retail end of the business

was terminated in 1880. James H. Forbes died in 1890. He installed the first Burns roaster in St. Louis, and claimed to have been the first commercial coffee roaster in the middle west. The company has branches in Kansas City and Omaha. On the death of Robert M. Forbes, in 1928, Mr. James H. Forbes, grandson of the founder, was elected president and the late C. P. Forbes, brother of James H., vice-president. Other officers and directors are: A. E. Forbes, chairman of the board; F. E. Stillman, vice-president; and H. H. Droste, secretary and treasurer.

William Schotten began his roasting business at St. Louis in 1862, although he had been in the grocery business since 1847. A short time later, a brother, Christian Schotten, came to the United States from Germany and was admitted to partnership, the firm becoming William Schotten & Bro. Christian died in 1866, and a brother-in-law, Henry Verborg, was admitted, the name being changed to William Schotten & Co. William died in 1874, and the business devolved upon his eldest son, Hubertus. In 1878, another son, Julius J., was taken in at the age of 17. Hubertus died in 1897, and Julius became manager and sole proprietor. He died in 1919. Since that time, his son, Jerome J., has carried on the business, which continues under the name of the Wm. Schotten Coffee Co.

The firm of David G. Evans & Co., St. Louis, was founded in 1858 by David G. Evans under the style of Flint, Evans & Co., changed in 1870 to David G. Evans & Co. David G. Evans died in 1916, and the name of the company was changed in 1917, to the David G. Evans Coffee Co., with Gwynne Evans, a son of David G., as president of the corporation.

The George Nash Grocery Co. bought the Eagle Coffee and Spice Mills from the estate of Mathew Hunt in 1870. About this time Michael E. Smith, who had been with the concern for a number of years, was made a partner. The firm was incorporated in 1887 as the Nash-Smith Tea & Coffee Co. In 1890, they opened a branch—Nash Coffee and Spice Co.—in Denver, under the management of Mr. Nash and his son, George A. The establishment in St. Louis continued under the management of Michael E. Smith, until his death in 1925. He was succeeded by his son, Walter M. Smith.

C. F. Blanke Tea & Coffee Co., import-

ing and jobbing house, St. Louis, was founded in 1889 by Messrs. C. F. Blanke, R. H. Blanke, A. J. Vogler, and Ed. Jerald. In 1894, Mr. William Fisher joined the company, taking charge of the tea and coffee department. In 1935, the C. F. Blanke Tea & Coffee Co. was discontinued and the Blanke Coffee Co. took its place, headed by William Fisher.

Other prominent St. Louis coffee roasting concerns that have made important contributions to coffee trade history are: the HP Coffee Co.; Norwine Coffee Co.; and St. Louis Coffee and Spice Mills.

**CINCINNATI.** Among the pioneer coffee roasters in Cincinnati were: John C. Appenzeller; Blook & Varwig; J. Brock; Cincinnati Spice Mills; Eagle Spice Mills; Harrison & Wilson; Parker & Dixon; Kilgour & Taylor; J. M. Krout; Succop & Lips; and H. R. Droste.

After the centennial year and previous to 1900, the following names were added: Potter & Parlin; James Heekin & Co.; Flugel & Popp; Utter, Adams & Ellen; J. Henry Koenig & Co.; F. W. Hinz; and the Woolson Spice Co.

D. Y. Harrison, then thirty-five years old, came from Newark, N. J., and settled in Cincinnati in 1843, opening a coffee roasting business as Harrison & Wilson. He used an old pull-out roaster with first a negro, and then a horse-power tread-mill, for power. A few years later, W. H. Harrison, a son of the founder, was admitted to the firm, the name at that time being Parker & Harrison. D. Y. Harrison died in 1872. Fire totally destroyed the plant in 1875. W. H. Harrison then formed a partnership with J. W. Utter, and started in again. He sold out to his partner in 1883 and went in business for himself as W. H. Harrison & Co. D. Y. Harrison is said to have been the first man to roast coffee west of Pittsburg.

The Heekin Company was established in 1869 by James Heekin and Barney Corbett as a partnership under the name of Corbett & Heekin. In a short time, Corbett died; and the name of the firm was then changed to James Heekin & Co. Alexander Stuart was admitted to the partnership about 1883, and retired four years later. James J. Heekin, older son of James Heekin, was admitted to partnership in 1892. Charles Lewis, after twenty years' experience in the coffee trade in Louisville, Cincinnati, and New York, was admitted to

the firm in 1895. James Heekin died in 1904. Upon his death a corporation was formed under the name of the James Heekin Company, with Charles Lewis as president, continuing until he retired in 1919. In this year a new corporation, called the Heekin Company, was formed, taking over the business of the James Heekin Co. and the Heekin Spice Co., the latter having been organized in 1899. James J. Heekin is chairman of the board, and Robert E. Heekin is president. Charles E. Lewis died in 1930.

Other present-day Cincinnati roasters that have made important contributions to coffee-trade history are: the Boat House Coffee & Tea Co.; F. W. Hinz & Sons Co.; The Janszen Co.; and J. Henry Koenig Co.

**KANSAS CITY.** Ennis-Hanly-Blackburn Coffee Co., coffee roasters and tea packers, succeeded the Gordon Coffee & Spice Co., which was formed in 1898 by Frank Ennis, E. D. Hanly, and G. S. Gordon. The officers of the firm are Frank Ennis, president; George A. Ennis, vice-president; and F. Robert Ennis, secretary.

J. A. Folger & Company's Kansas City branch was opened in 1907 by F. P. Atha, who began work as a coffee salesman for Holman & Co., Terra Haute, Ind. He went to San Francisco in 1899 and entered the employ of J. A. Folger & Co., of that city, and introduced their products east of the Rockies. In 1908, he was admitted to the firm and made vice-president and general manager.

Other Kansas City firms that have made important contributions to coffee trade history are the H. D. Lee Mercantile Co. and Ridenour-Baker Grocery Company.

**DULUTH.** Andresen-Ryan Coffee Co.; Rust-Parker Co.; and Stone, Ordean Wells Co.—the two latter, wholesale grocers—have contributed in a large way to the history of the coffee trade in territory north and west of the head of the lakes.

**ST. PAUL.** Griggs, Cooper & Co., wholesale grocer and coffee roaster, was established in 1882 by Col. C. W. Griggs, under the name of Glidden, Griggs & Co. He gave an interest in the firm to his eldest son, C. Milton Griggs. At the end of the first year there was an amalgamation with Yantz & Howes, also established in 1882. J. W. Cooper came into the firm in 1890 and the name was changed to Griggs, Cooper & Co. In 1900, the business was

incorporated. In the early 'nineties, Clark E. Wyman became manager of the tea and coffee department, succeeding T. C. White. From 1900 until his death in 1931, Mr. Wyman was a director of the company. The present officers are: E. G. Griggs, chairman of the board; M. W. Griggs, president; and B. G. Griggs, vice-president in charge of the tea and coffee department.

MINNEAPOLIS. In 1901, S. Holstad became a member of the firm of Atwood & Holstad. He withdrew in 1908 to form the firm of S. Holstad & Co., with Charles Ekelund and Alexander W. Kreiser as partners. After the withdrawal of Mr. Holstad from Atwood & Holstad, Mr. Atwood continued as Atwood & Co.

The Baker Importing Co., packers of "Barrington Hall" coffee is another old-established Minneapolis coffee-roasting concern.

LOUISVILLE. Pioneers in this early center of coffee roasting in the south were: Thornton & Hawkins; Charles J. Bouche; H. N. Gage; A. Engelhard; and Jacob Zinsmeister.

R. J. Thornton & Co. were founded in 1837 by Richard J. Thornton and Thomas Hawkins, as Thornton & Hawkins. Thornton died in 1860. His interests remained, but the firm changed to Hawkins & Thornton. Hawkins died in 1877, and Mrs. Thornton, having purchased the Hawkins interest, ran the business as R. J. Thornton & Co., the present style of the firm, until her death in 1885. John Hayes, her son-in-law, then bought the company; and when he died in 1904, his widow ran the business with Thomas A. Crawford as manager. Mrs. Hayes, the last of the Thornton family, died in 1919, and her interests were sold to Crawford and R. H. Dorn, an old employee. The firm first roasted coffee about 1846. It is interesting to note that the plant has occupied the present site since its founding, ninety-eight years ago.

Albert Engelhard, Sr., founded in 1855 a wholesale grocery house which later became A. Engelhard & Sons, Inc. In 1879, George, in 1882, Victor H., and in 1883, Albert, Jr., all sons of the founder, entered the business. Upon moving into larger quarters in 1890, all of the sons were taken in as partners. Albert Engelhard, Sr., retired in 1892, and the management was assumed by Victor H. The business

was incorporated in 1901 and the wholesale grocery end was abandoned in 1903; the concern becoming a strictly coffee, tea, and spice house. Victor H. Engelhard died in 1918, and his sons, Victor, Jr., and R. W. Engelhard, who had been in the business for several years, assumed active management. Victor Engelhard, Sr., was prominent in coffee affairs and in the early work of the National Coffee Roasters Association. The business was liquidated in 1928.

Jacob Zinsmeister, of J. Zinsmeister & Sons, was another old-time Louisville coffee man. Before he started roasting, he was a big factor in the green coffee trade. The business was established in 1866 at New Albany, Ind., by Frank Zinsmeister, Sr., but was later moved to Louisville. Jacob Zinsmeister was taken into the business in 1872, and the name was changed to Frank Zinsmeister & Son.

NEW ORLEANS. Men and firms active in early coffee roasting in New Orleans were: Shaw's Louisiana Coffee and Spice Mills; Ruliff, Clark & Co.; R. Poursini & Co.; and Smith & McKenna.

Between 1876 and 1900 were added: New Orleans Coffee Co.; Smith Bros. & Co.; Southern Coffee Polishing Mills; and Cage & Drew.

Smith Bros. & Co. were organized in 1863 as Smith & McKenna. Mr. McKenna died in 1872, and the firm name was changed to Smith Bros. & Co. The two Smith brothers died in 1891 and 1892. About 1900, the name became Smith Bros. & Co., Ltd., and J. B. Sinnot, who had been employed for a number of years by the firm, gained control. The company failed in 1913. Mr. Sinnot then entered the coffee brokerage business, in which he remained until his death in 1917.

Born in New Orleans in 1865, the late Daniel H. Hoffman started work as a sample clerk in the office of E. P. Cottraux, who was at that time the only coffee broker in New Orleans. In 1887, Mr. Hoffman started in business for himself. In 1894, he opened the Southern Coffee Polishing Mills, which have since become the Southern Coffee Mills, Inc.

W. T. Jones, for many years in business as a coffee broker in Keokuk, Iowa, founded the New Orleans Coffee Co. in 1890. He died in 1919.

R. H. Cage and J. C. Drew organized in 1898 the firm of Cage & Drew. In 1900,



they established the Louisiana Coffee Mills under the name and style of Cage, Drew & Co., Ltd.

Ben C. Casanas joined the New Orleans Coffee Co. as a city salesman, and later became a road salesman. He withdrew in 1901 to organize the Merchants Coffee Co. of New Orleans, Ltd.

William B. Reily and Co., Inc., tea and coffee packing house, was founded in 1903 by William Boatner Reily. In 1906, the name was changed to the Reily Taylor Co., Inc.; and in 1919, to Wm. B. Reily, Inc. Mr. William B. Reily, the founder, is president. Associated with him are his two sons; one of whom, William B. Reily, Jr., is vice-president, and the other, James W. Reily, is secretary.

**SAN FRANCISCO.** Pioneer coffee roasters in San Francisco were: J. A. Folger & Co.; Charles Berhard; H. Gates; D. Ghirardelli & Co.; E. Loeven & Co.; Marden & Myrick; Maine & Eckerenkotter; G. Venard; and Charles Zwick.

Between 1876 and 1900 the following were added: A. Schilling & Co.; W. H. Miner; Siegfried & Brandenstein; George W. Caswell.

J. A. Folger & Co. were established in 1850 as Wm. H. Bovee & Co. A few years later, the name became Marden & Folger, Mr. Folger having been connected with the old firm. In the early 'sixties the name was changed to J. A. Folger & Co. Two employees were taken into the firm in 1878. These were A. Schilling and a Mr. Lamb. The company was then called Folger, Schilling & Co. This partnership was dissolved in 1881, and the business continued as J. A. Folger & Co. Mr. Folger died in 1890, and the firm was then incorporated under the same name. Mr. J. A. Folger, Jr., son of the founder, who entered the business in 1889, died in 1921.

Shortly after Folger, Schilling & Co. was dissolved, A. Schilling and George Volkmann formed the firm of A. Schilling & Co. Mr. Schilling began his career as an office boy with J. A. Folger in 1871. He died in 1934. The company has fourteen branch warehouses, where stocks are carried. The directors are: George F. Volkmann, Rudolf Schilling, William G. Volkmann, and Daniel G. Volkmann.

M. J. Brandenstein and John C. Siegfried formed a co-partnership under the name of Siegfried & Brandenstein in 1881. Mr. Brandenstein bought out his partner

in 1890, and took in his brothers, Manfred and Edward, the firm name becoming M. J. Brandenstein & Co. M. J. Brandenstein died in 1925, and in the following year the business was incorporated under its present style as the M.J.B. Co.

George W. Caswell started in the retail tea and coffee business in San Francisco under his own name in 1884. In 1898, the business became wholesale only. It was incorporated in 1901 as the George W. Caswell Co. The company took over the brands and traveling organization of Lievre, Frick & Co. in 1902. George W. Caswell died in 1935.

The Jones-Thierbach Company, tea, coffee, and spice packer, San Francisco, was founded by Frank Randal and M. P. Jones in 1856 under the name of Randal & Jones. Mr. Webster Jones, president of the company, is the son of M. P. Jones. Mr. Charles F. Thierbach entered the business in 1881 and died in 1931. George C. Thierbach is vice president. Norman H. Wear is general manager.

Hills Brothers was founded in 1878 by A. H. and R. W. Hills, and are now one of the country's largest coffee roasting firms. They were the first to pack coffee in vacuum cans, in 1900. Both of the brothers have since died, the business continuing under the same name.

Other San Francisco firms that have made important contributions to coffee-trade history are: Alexander-Balart Co.; and California Packing Corporation.

**MILWAUKEE.** Prominent among early coffee roasters of Milwaukee were: W. & J. G. Flint; James Ryan & Co.; J. B. Reynolds; Jewett & Sherman; and C. E. Andrews & Co. Later there was added the Wm. Grossman Co.

J. G. Flint and Wyman Flint founded the business known as W. & J. G. Flint in 1858. J. G. Flint bought out his brother in 1880 and continued as the J. G. Flint Co., owner of the Star Coffee and Spice Mills. He died in 1896. The business was incorporated in 1901 as the J. G. Flint Co., with W. K. Flint, a son of J. G., as president. The Jewett & Sherman Co. took control in 1911.

Professor Milo P. Jewett, Professor S. S. Sherman, and his brother, William Sherman, founded the firm of Jewett, Sherman & Co. in 1867, and continued under that name until 1875, when it was incorporated as Jewett & Sherman Co., with Milo P.

Jewett as president, and Henry B. Sherman, secretary and treasurer. Professor S. S. Sherman and his sons, Fred and Henry B., sold out their interests in 1878 and formed a new business in Chicago under the name of Sherman Bros. & Co. William M. Sherman then became president of Jewett & Sherman Co., and Charles A. Murdock, a nephew of S. S. and William Sherman, was made secretary and treasurer. Mr. Murdock withdrew in 1881 and established the C. A. Murdock Mfg. Co. in Kansas City. In that same year, William H. Sherman, another nephew, became a stockholder and one of the directors of Jewett & Sherman Co. Dr. Lewis Sherman succeeded his father as president of the company in 1891, and served in that capacity until his death in 1915, when he was succeeded by his son, Lewis Sherman. John Horter, who joined the business in 1877, is now president, and Lewis Sherman is chairman of the board.

William Grossman started in the wholesale grocery business in 1886. John and Henry Dahlman were admitted to partnership in 1889. About three years later, the latter closed out his interests to J. F. W. Imbusch. The present corporation was established in 1892 as Wm. Grossman & Co. The firm was incorporated August 1, 1916, as the Wm. Grossman Co., with Wm. Grossman as president, George A. Grossman as vice-president, and Paul E. Apel as secretary and treasurer.

Another old-time coffee man of Milwaukee was Charles A. Clark, who had been in the coffee business for nearly twenty years before he organized the present business of Clark & Host Co.

Roundy, Peckham & Dexter Co., wholesale grocers, importers, and packers, Milwaukee, was founded in 1872 under the name of Smith, Roundy & Co., by the then governor, William Smith, and J. A. Roundy and Sidney Hauxhurst. In 1878, Governor Smith retired and the name was changed to Roundy, Peckham & Co. The business was incorporated in 1903 under the present style of Roundy, Peckham & Dexter Co. Mr. Hauxhurst died in 1902. Mr. C. J. Dexter is now president.

Other Milwaukee coffee roasting concerns that have made important contributions to coffee trade history are: E. R. Godfrey & Sons Co.; John Hoffmann & Sons Co.; O. R. Pieper Co.; and Tindall, Kolbe & McDowell Co.

TOLEDO. The pioneer roasting firms here seem to have been: Warren & Bedwell; and J. B. Baldy & Co. Later, after 1876, we find added the Bour Company, and the Woolson Spice Co.

The latter company was founded in 1882 by A. M. Woolson, who up to that time had conducted a successful retail grocery business for several years. The Woolson Spice Co. was sold to H. O. Havemeyer of New York in 1896, the reputed sale price being \$2,000,000. A. M. Woolson retired from business at that time, and died in 1925. Upon the death of Mr. Havemeyer, the company passed into the hands of Hermann Sielcken, who in turn sold it to the present Woolson Spice Co. in 1917. J. W. Koehran is president.

The Bour Company was incorporated in 1892, following a partnership which had succeeded to a small business concern under the name of the Eagle Spice Company. The principal stockholders were: J. M. Bour, F. G. Kendrick, and Albro Blodgett. Mr. Blodgett bought the Bour interests in 1909 and with S. W. Beckley, who had been sales manager for a number of years, acquired practically all the other outside interests. The name was changed in 1921 to the Blodgett-Beckley Co., the officers being Albro Blodgett, president, S. W. Beckley, vice-president and manager, and Henry P. Blodgett, secretary and treasurer. In 1934 the business was purchased by the Weideman Co., Cleveland.

Other Toledo coffee roasting concerns that have made important contributions to coffee trade history are: the Berdan Co.; Harnit & Hewitt Co.; and Karavan Coffee Co.

CLEVELAND. Pioneers in Cleveland were: Smith & Curtis; A. Stephens & Sons; John H. Ganse; and W. D. Drake & Co. In 1870, we find Edwards, Townsend & Co.; Knight, Eberman & Co.; Talbot, Winslow & Co.; Williams & Tait; and Lemmon & Sons, added.

Beards & Cummings, coffee roasters of New York City, established a branch in Cleveland under the management of Alvan Stephens in 1855. Later, Stephens took over the business for himself and changed the name to Frisbie & Stephens. In 1861 Alvan's sons, Henry A. and Samuel R., were admitted and the firm became A. Stephens & Sons. Alvan Stephens died in 1873, and Samuel moved to Chicago to open a branch. He died in 1878. Henry A.

continued the business until 1881, when Francis Widlar was admitted to partnership, and the name was changed to Stephens & Widlar. Henry A. Stephens died in 1897, and A. L. Somers, H. H. Hewitt, and D. D. Hudson, all old employees, were admitted, and the firm name was changed to F. Widlar & Co. Carl W. Brand, a nephew of Francis Widlar, joined the company in 1898. Upon the death of his uncle, the business was incorporated as the Widlar Co., and Mr. Brand became president in 1910. By a re-organization, in 1928, the company became the Widlar Food Products Co., which, in 1929, was taken over as a unit of Standard Brands, Inc., New York.

Other Cleveland coffee roasting concerns that have made important contributions to coffee-trade history are: Wm. Edwards Co. and the Weideman Co.

**PITTSBURGH.** Next to New York, Pittsburgh was one of the first cities to forge to the front as a coffee-roasting center. These are the firms that were among the leaders in the period between 1860 and 1870: Arbuckles & Co.; W. T. Bown & Bro.; Dilworth Bros.; Rinehart & Stevens; T. C. Jenkins & Bro.; Carter Bros. & Co.; J. S. Dilworth & Co.; Jesse H. Lippincott; Shields & Boucher; and Haworth & Dewhurst.

Samuel Young, Samuel Mahood, and E. B. Mahood formed a partnership as Young, Mahood & Co. in 1879. E. B. Mahood withdrew in 1890. Samuel Mahood retired in 1906, and the company was incorporated as the Young-Mahood Company, with Samuel Young as president, and W. James Mahood as vice-president and general manager.

**PORTLAND, OREGON.** Early roasters in the trade of this city were: J. F. Jones; H. C. Hudson & Co.; Marden & Folger; Verdier & Closset; and Closset & Devers.

Joseph and Emile Closset formed a partnership as Closset Bros. in 1880. A. H. Devers, who had been a salesman with Folger, Schilling & Co., San Francisco, and later with A. Schilling & Co., bought out Emile Closset in 1883, and the firm took its present name as Closset & Devers. Joseph Closset died in 1915.

The General Grocery Company, Inc., wholesale grocers and packers, Portland, Oregon, is a merger, effected in 1928, of Allen & Lewis, Lang & Company, and Mason, Ehrman & Co., together with the purchase of T. W. Jenkins & Co. The

## Office of Forest City Coffee & Spice Mills,

No. 20 MERWIN STREET,

CLEVELAND, OHIO.

GREEN COFFEES having advanced largely the past week, we quote our prices of GROUND COFFEE, until further notice, as follows:

Best Mocha.....	Coffee, 29	cts. $\frac{1}{2}$ lb.
Best Old Gov't Java....	" 27	" "
Pure Java.....	" 24	" "
Fresh Java.....	" 22	" "
Best Rio .....	21	
Pure Rio.....	19	
Dandilon.....	16	" "
Pure West India.....	16	" "
No. 1 West India.....	" 14	" "
Union.....	12	" "

Hoping to be favored with your further orders, we remain,

Yours Respectfully,

A. Stephens & Son.

Cleveland, Oct. 14th, 1892.

### GROUND COFFEE PRICE LIST OF 1862

constituent companies were old-established wholesale grocers that had been competing for approximately sixty years. They also were roasters and packers of coffee. The officers are: J. W. Stuchell, president; William Heller Ehrman; vice-president; S. Mason Ehrman, vice-president; and H. F. Bragg, secretary-treasurer.

Other Portland concerns that have made important contributions to coffee trade history are Dwight Edwards & Co., and Wadhams & Co., Inc.

**BALTIMORE.** Pioneer roasters in Baltimore were: Joseph Braas; Daniel Many; George Pearson; Sylvester Ruth; and John G. Siegman. These were quickly followed by Barclay & Hasson; Zoller & Little; Benjamin Berry; Jesse Lazear; and others.

Later, after 1876, came: E. Levering & Co.; the Enterprise Coffee Co.; C. D. Kenny; J. W. Laughlin & Co., later Le Morgan Coffee Co.; and the Saxon Coffee Company.

Other Baltimore concerns that have made important contributions to coffee trade history are: C. H. Kroneberger & Co.; Levering Coffee Co.; and Merchants Coffee Co.

**DETROIT.** In Detroit in 1860-70 were: Evans & Walker; Farrington Campbell & Co.; A. R. & W. F. Linn; J. H. Riggs; and Palmer, Warner & Co. After 1876 were added Sinclair, Evans & Elliot; Huber & Stendel; and J. A. Parent & Co.

Present-day Detroit coffee-roasting firms that have made important contributions to coffee-trade history are: R. S. Gehlert & Co.; John E. King Coffee Co.; Lee & Cady; Phelps, Krag & Co.; and the Telfer Coffee Co.

**OTHER CITIES.** Names of pioneer roasters of other towns in 1860 and 1870 were: George Boardman, Albany, N. Y.; Chubbuck & Saunders, Binghamton, N. Y.; George W. Hayward, and P. J. Ferris, Buffalo, N. Y.; Lorimer Bros., and George R. Forrester, Elmira, N. Y.; Hatch & Jenks, Jamestown, N. Y.; N. B. Beede, Newburgh, N. Y.; A. F. Booth, Poughkeepsie, N. Y.; Ethridge, Tuller & Co., Rome, N. Y.; M. N. Van Zandt & Co., L. B. Eddy & Co., and C. T. Moore, Rochester, N. Y.; Ostrander, Loomis & Co., and Jacob Crouse & Co., Syracuse, N. Y.; C. H. Garrison, Troy, N. Y.; Hinchman & Howard, and J. Griffiths & Co., Utica, N. Y.; B. F. Hoopes, Bloomington, Ill.; C. P. Farrell, and Charles Richards, Peoria, Ill.; Slemmons & Conkling, Springfield, Ill.; Henry Wales, Bridgeport, Conn.; A. B. Gillett, Wm. Boardman & Sons, Hartford Steam Coffee & Spice Mills, and Park, Fellowes & Co., Hartford, Conn.; Benj. Peck & Kellum, and Steele & Emery, New Haven, Conn.; W. S. Scull & Co., Camden, N. J.; Theo. F. Johnson & Co., and the Pioneer Mills, Newark, N. J.; Charles A. Dunham, New Brunswick, N. J.; James Ronan and Wm. Dolton & Co., Trenton, N. J.; Butler, Earhart & Co., Columbus, Ohio; C. A. Trentman & Bro., and J. D. Beach & Co., Dayton, Ohio; W. & S. Stevens, and F. C. Dietz, Zanesville, Ohio; J. E. Tone, Des Moines, Iowa; H. P. Hess, Cornell & Smith, and E. Warne, Easton, Pa.; E. S. Forster, Erie, Pa.; Haehnlen Bros., Harrisburg, Pa.; D. G. Yuengling, Pottsville, Pa.; A. G. Zilmore & Co., Scranton, Pa.; Granger & Co., Titusville, Pa.; Huestis & Hamilton, and B. Trentman & Son, Ft. Wayne, Ind.; S. Hamill & Co., Keokuk, Ia.; H. H. Lee, and Maguire & Gillespie, Indianapolis, Ind.; Joseph Strong, Terre Haute, Ind.; Curtis & Burnham, Leavenworth, Kan.; Yates & Dudley, Lexington, Ky.; A. Turner, Wheeling, W. Va.; Granger &

Hodge, and Nathaniel Crocker, St. Paul, Minn.; W. W. Totten & Bro., Nashville, Tenn.; Henry Burns, Savannah, Ga.; A. McFarland, Springfield, Mass.; Alexander Wills & Co., Montreal, Canada; and Peter Hendershot, St. Catherine, Canada.

Between 1876 and 1900, many other names came into prominence, and among them mention should be made of: H. Hulman, Terre Haute, Ind.; A. B. Gates & Co., and Schnull & Krag, Indianapolis, Ind.; O. W. Pierce Co., and Geiger-Tinney Co., Lafayette, Ind.; Twitchell, Champlin & Co., Portland, Me.; Nave-McCord Mfg. Co., Mokaska Mfg. Co., and the Midland Spice Co., St. Joseph, Mo.; Beaham-Moffatt Mfg. Co., and C. A. Murdock & Co., Kansas City, Mo.; Clarke Bros. & Co., T. S. Grigor & Co., Consolidated Coffee Co., and McCord, Brady Co., Omaha, Neb.; Dayton Spice Mills Co., and Canby, Ach & Canby, Dayton, Ohio; Ohio Coffee & Spice Co., and Butler, Crawford & Co., Columbus, Ohio; Bacon, Stickney & Co., Albany, N. Y.; Charles R. Groff Co., St. Paul, Minn.; John G. Schuler, Covington, Ky.; J. W. Thomas & Son, Nashville, Tenn.; Geo. F. Hanley & Co., Los Angeles, Cal.; C. S. Morey Mercantile Co., Denver, Col.; and W. G. Lown Coffee Co., Washington, D. C.

William Boardman, founder of Wm. Boardman & Sons Co., Hartford, Conn., began roasting coffee at Wethersfield in 1841 with a hand-power roaster, using wood for fuel. He moved his plant to Hartford in 1850. In the same year, his son Thomas J., after serving a fifteen-year apprenticeship in a country store, entered his father's employ. Three years later, he and his brother, William F. J. Boardman, were admitted to the firm, the name being changed to Wm. Boardman & Sons. Howard F. Boardman, a son of Thomas J., began working in the business in 1880, and was admitted to partnership in 1888. The same year, the founder died and William F. J. retired. In 1898, the concern was incorporated under its present style as The William Boardman & Sons Co. Mr. Thomas J. Boardman died in 1923 at the age of ninety-one. Mr. John Pepion entered the employ of the firm as a young man, and was taken into the company in 1898. The present directors are: John Pepion, president; John Pepion, Jr., vice president and treasurer; and Gordon B. Pepion, secretary.

The O. W. Pierce Company, Lafayette, Ind., was founded in 1847 by Oliver Webster Pierce, Sr. Except for three years in the fifties, when the firm was known as Reynolds, Hatcher & Pierce, it has been known as the O. W. Pierce Company. The company was incorporated in 1905 with O. W. Pierce, Jr., as its head. The senior Mr. Pierce died in 1921. The firm first roasted coffee in 1891. Prior to that time it had been in the wholesale grocery business.

The William S. Scull Co., Camden, N. J., was established in 1831 by William S. Scull, who conducted the business under his own name until 1858. In that year, he was succeeded by his son, William S. Scull, under whose name the business was conducted until 1871, when the style was changed to Wm. S. Scull & Co. The business was incorporated as the Wm. S. Scull Co. in 1908. Mr. William S. Scull died in 1916. In recent years the company has acquired by purchase the businesses of Geo. C. Buell & Co., Rochester, and the Canby, Ach & Canby Co., Dayton. Previous to its merger with the Scull Co., the Canby, Ach & Canby Co. acquired the business of E. R. Webster Co., Cincinnati. The 104-year-old Scull enterprise starts its second century with the third generation of the family carrying on the business; William C. Scull, grandson of the founder, is president; J. Carl de la Cour, first vice president; and Lot Boardman, second vice president and general manager.

H. Newmark founded H. Newmark & Co. in Los Angeles in 1865. He retired in 1886, and Maurice H. Newmark was made a full partner. He retired from the business in 1926, and died in 1929.

In 1868, Major David B. Hamill entered, as junior partner, the firm of S. Hamill & Co., Keokuk, Iowa, of which his father, Smith Hamill, was the head. Smith Hamill died in 1890, and David B. became head of the firm. He died in 1916.

William Tackaberry was a junior partner in the firm of S. Hamill & Co., Keokuk Iowa. He began a business of his own in the same city in 1868. Ten years later, he moved the company to Sioux City, and continued there as the Wm. Tackaberry Co.

Joel O. Cheek began traveling for the wholesale grocery house of Webb, Hughes & Co., Nashville, Tenn., in 1873. Later, he was admitted to partnership, the firm becoming Webb, Cheek & Co., and then Cheek,

Norton & Neal. He formed the Nashville Coffee & Mfg. Co., in 1899. It was merged in 1905 into the Cheek-Neal Coffee Co. In 1928, the Postum Company acquired the business and changed its name to Maxwell House Products Company, Inc., with headquarters in New York. In 1929 the name of the Postum Company was changed to General Foods Corporation.

Jekiel and Isaac E. Tone began the business of Tone Bros. at Des Moines, Iowa, in March, 1873, with one roaster and one spice mill. The business was incorporated in 1897. Jekiel Tone died in 1900, and Isaac E. Tone in 1916. The business continues under the same name.

Edward Canby began business in Dayton, Ohio, in 1875, succeeding the firm of J. D. Beach & Co. He retired in 1886, and the business was left in charge of Frank L. Canby and F. J. Ach. The latter had entered the employ of Canby in 1877. He secured an interest in the business in 1882, and became a partner in 1890. When the company was incorporated as Canby, Ach & Canby in 1904, he was elected president. Mr. Ach was prominent in the affairs of the National Coffee Roasters Association. In recent years the business was sold to Wm. S. Scull Co., Camden, N. J., and continues as their Dayton branch under the style of Wm. S. Scull Co., Canby, Ach & Canby Division. F. J. Ach died in 1935.

Frank J. Geiger began in the tea, coffee, and spice business in Lafayette, Ind., under the name of Culver & Geiger. Mr. Culver, who had never been active, died in 1889, and in 1892 the Geiger-Tinney Company was formed with F. J. Geiger as president. The plant was moved to Indianapolis in 1901 with William L. Horn as vice-president, and Henry C. Tinney as secretary and treasurer. The name was changed to the Geiger-Fishback Co. in 1912, and Mr. Geiger retired. Frank S. Fishback acquired all the stock of the company in 1918, and the name was changed to the Fishback Co., now the Virginia Sweet Foods, Inc.

Paxton & Gallagher Co., wholesale grocers, Omaha, succeeded Paxton & Gallagher, founded in 1864 by Ben Gallagher and William A. Paxton. The firm has branches in Lincoln, Des Moines, Sioux City, Cedar Rapids, Waterloo, Denver, Cheyenne, Casper, Deadwood, and Sioux Falls. The officers of the company are:



Paul C. Gallagher, president and treasurer; F. E. Pearce and R. K. Gallagher, vice-presidents; T. J. Jenkins, secretary and assistant treasurer. T. J. Prettyman is coffee buyer for the firm and Roger P. Holman, coffee sales and advertising manager.

Other roasters in various cities who have made important contributions to coffee-trade history include: Coffee Products of America, Inc., Haas Baruch & Co., and Huggins-Young Co., Los Angeles; the Dern Co., Colorado Springs; Morey Mercantile Co., Denver; Jno. H. Wilkins Co., Washington; Oakford & Fahnestock, Peoria; Virginia Sweet Foods Co., Indianapolis; Western Grocer Co., Marshalltown; Black Hawk Coffee & Spice Co.; American Coffee Co., New Orleans; F. B. Price, Butte; Holbrook Grocery Co., Keene, N. H.; Bacon, Stickney & Co., Albany; Beech-Nut Packing Co., Canajoharie; Franklin Coffee Co., Columbus; Dayton Spice Mills Co., Dayton; Ohio Valley Coffee Corp., Portsmouth, O.; Campbell & Woods Co., Pittsburgh; Brownell & Field Co., Providence; F. W. Wagener Co., Charleston, S. S.; Maury-Cole Co., Memphis; Dal-Tex Coffee Co., Dallas; Duncan Coffee Co., Houston; Shear Coffee Co., Waco; Hewlett Bros., Salt Lake City; Jas G. Bill Co., Norfolk, Va.; C. W. Antrim & Sons, Richmond; Commercial Importing Co. and Crescent Manufacturing Co., Seattle; and Sehon, Stevenson & Co., Huntington, W. Va.

#### Coffee Roaster Statistics

As might be expected, considering the leading place that New York holds as a port of entry for coffee, the roasting and grinding of coffee is more important in the eastern section of the country than in any other. But there are many establishments for preparing coffee scattered throughout the south and the middle west, and the business has grown to considerable proportions on the Pacific coast. As shown by the accompanying table, New York state leads in the number of establishments and is followed by California, Pennsylvania, Illinois, Texas, Ohio, Missouri, Louisiana, Massachusetts, Michigan, etc., in the order given.

#### COFFEE AND SPICE ROASTING AND GRINDING ESTABLISHMENTS

States	CENSUS OF 1931		Value of Products
	No. of Establishments	Average No. of Wage Earners	
Alabama	9	61	\$1,361,693
Arkansas	11	39	757,599
California	75	813	37,809,393
Colorado	13	85	2,041,875
Connecticut	6	23	464,904
Dist. of Columbia	7	56	2,529,576
Florida	23	96	2,685,109
Georgia	14	44	1,049,026
Illinois	59	941	35,410,196
Indiana	15	76	1,719,819
Iowa	13	130	2,286,399
Kansas	15	42	956,671
Kentucky	14	69	1,436,079
Louisiana	36	239	6,023,986
Maryland	21	181	5,547,155
Massachusetts	31	467	12,857,390
Michigan	27	123	3,848,579
Minnesota	20	205	6,657,379
Mississippi	13	32	534,674
Missouri	45	673	18,992,996
Montana	4	8	152,599
Nebraska	8	233	3,453,085
New Jersey	15	166	7,457,077
New York	120	1,529	53,507,715
North Carolina	6	10	182,348
Ohio	51	851	18,019,123
Oklahoma	15	72	1,894,309
Oregon	9	69	2,551,640
Pennsylvania	60	393	13,974,921
South Carolina	8	8	205,198
Tennessee	22	201	5,213,657
Texas	59	376	9,861,819
Utah	4	12	216,061
Virginia	13	79	1,672,799
Washington	20	165	4,179,163
West Virginia	5	37	695,342
Wisconsin	16	83	2,564,242
Other states*	15	32	722,985
<b>Total</b>	<b>917</b>	<b>8,719</b>	<b>\$271,494,581</b>

\* Delaware, 1 establishment; Idaho, 3; Maine, 3; New Hampshire, 3; Rhode Island, 1; South Dakota, 3; Vermont, 1.

The industry, as defined for census purposes, covers in general the roasting and grinding of coffee and the grinding of spices for the trade. This joint classification was found necessary because most establishments handle both coffee and spices. A comparison of the 1931 census figures with the pre-war census, in 1914, shows increases of approximately 25 per cent in the number of establishments; 2 per cent in the average number of employees; and 44 per cent in the value of the products.

## CHAPTER XXXI

### SOME BIG MEN AND NOTABLE ACHIEVEMENTS

B. G. ARNOLD, THE FIRST, AND HERMANN SIELCKEN, THE LAST OF THE AMERICAN "COFFEE KINGS"—JOHN ARBUCKLE, THE ORIGINAL PACKAGE-COFFEE MAN—JABEZ BURNS, THE MAN WHO REVOLUTIONIZED THE ROASTED COFFEE BUSINESS BY HIS CONTRIBUTIONS AS INVENTOR, MANUFACTURER, AND WRITER—ALEXIOUS VAN GÜLPEN AND THEODOR VON GIMBORN—COFFEE-TRADE BOOMS AND PANICS—BRAZIL'S FIRST VALORIZATION ENTERPRISE—WAR-TIME GOVERNMENT CONTROL OF COFFEE—THE STORY OF SOLUBLE COFFEE

IN THE history of the coffee trade of Europe and the United States, several names stand out because of notable contributions made to the development of the industry. In green coffee, we have B. G. Arnold, the first, and Hermann Sieleken the last, of the "coffee kings"; in the roasting business, there was John Arbuckle, the original national-package-coffee man; and in the coffee-roasting machinery business, Jabez Burns, inventor, manufacturer, and writer, in the United States; and Alexius van Gülpen and Theodor von Gimborn in Germany.

#### *The First "Coffee King"*

Benjamin Green Arnold came to New York from Rhode Island in 1836 and took



a job as accountant with an east-side grocer. He was thrifty, industrious, and kept his own counsel. He was a born financial leader. Fifteen years later he was made a junior partner in the firm. By 1868, the bookkeeper of 1836 was the head of the business, with a line of credit amounting to half a million dollars—a notable achievement in those days.

Mr. Arnold embarked upon his big specu-

lation in coffee in 1869. For ten years he maintained his mastery of the market, and in that time amassed a fortune. It is related that one year's operations of this daring trader yielded his firm a profit of a million and a quarter dollars.

B. G. Arnold was the first president of the New York Coffee Exchange. He was one of the founders of the Down Town Association in 1878. The president of the United States was his friend, and a guest at his luxurious home. But the high-price levels to which Arnold had forced the coffee market started a coffee-planting fever in the countries of production. Almost before he knew it, there was an overproduction that swamped the market and forced down prices with such amazing rapidity that panic seized upon the traders. Few that were caught in that memorable coffee maelstrom survived financially.

Arnold himself was a victim, but such was the man's character that his failure was regarded by many as a public misfortune. Some men differed with him as to the wisdom of promoting a coffee corner, and protested that it was against public policy; but Arnold's personal integrity was never questioned, and his mercantile ability and honorable business dealings won for him an affectionate regard that continued after his fortune had been swept away.

After the collapse of the coffee corner, Mr. Arnold resumed business with his son, F. B. Arnold. He died in New York, December 10, 1894, in his eighty-second year.

The son died in Rome in 1906. The business which the father founded, however, continues today as Arnold, Dorr & Co., one of the most honored and respected names in Front Street.

*Hermann Sielcken, the Last Coffee King*

If B. G. Arnold was the first coffee king, Hermann Sielcken was the last, for it is unlikely that ever again, in the United States, will it be possible for one man to achieve absolute dictatorship of the green coffee business.

There never was a coffee romance like that of Hermann Sielcken's. Coming to



Mr. Hermann Sielcken

America a poor boy in 1869, forty-five years later, he left it many times a millionaire. For a time, he ruled the coffee markets of the world with a kind of autocracy such as the trade had never seen before and probably will not see again. And when, just before the outbreak of the World War, he returned to Germany for the annual visit to his Baden-Baden estate, from which he was destined never again to sally forth to deeds of financial prowess, his subsequent involuntary retirement found him a huge commercial success, where B. G. Arnold was a colossal failure. It was the World War and a lingering illness that, in the end, stopped Hermann Sielcken. But, though he had to admit himself bested by the fortunes of war, he was still undefeated in the world of commerce. He died in his native Germany in 1917, the most commanding, and the most cordially disliked, figure ever produced by the coffee trade.

Hermann Sielcken was born in Hamburg in 1847, and so was seventy years old when he died at Baden-Baden, October 8, 1917. He was the son of a small baker in Hamburg; and before he was twenty-one, he went to Costa Rica to work for a German firm there. He did not like Costa Rica, and within a year he went to San Francisco, where, with a knowledge of English already acquired, he got a job as a shipping clerk. This was in 1869. A wool concern engaged him as buyer, and for about six years he covered the territory between the Rockies

and the Pacific, buying wool. On one of these trips he was in a stage-coach wreck in Oregon and nearly lost his life. He received injuries affecting his back from which he never fully recovered, and which caused the stooped posture which marked his carriage through life thereafter. When he recovered, he came to New York seeking employment, and obtained a clerical position with L. Strauss & Sons, importers of crockery and glassware. In 1880, he married Josephine Chabert, whose father kept a restaurant in Park Place.

Sielcken had learned Spanish in Costa Rica, and this knowledge aided him to a place with W. H. Crossman & Bro. (W. H. and George W. Crossman) merchandise commission merchants in New York. He was sent to South America to solicit consignments for the Crossman's and was surprisingly successful. For six or eight months every South American mail brought orders to the house. Then, as the story goes, his reports suddenly ceased. Weeks and months passed, and the firm heard nothing from him.

The Crossmans speculated concerning his fate. It was thought he might have caught a fever and died. It was almost impossible to trace him; at the same time it distressed them to lose so promising a representative. Giving up all hope of hearing from him again, they began to look around for some one to take his place. Then, one morning, he walked into the office and said, "How do you do?" just as if he had left them only the evening before. The members of the firm questioned him eagerly. He answered some of their questions; but most of them he did not. Then he laid a package on the table.

"Gentlemen," he said, "I have given a large amount of business to you, far more than you expected, as the result of my trip. I have a lot more business which I can give to you. It's all in black and white in the papers in this package. I think any person who has worked as hard as I have, and so well, deserves a partnership in this firm. If you want these orders, you may have them. They represent a big profit to you. Good work deserves proper reward. Look these papers over, and then tell me if you want me to continue with you as a member of this firm."

After the Crossmans had looked the papers over they had no doubt of the advisability of taking Sielcken into partner-

ship. He was admitted as a junior in 1881-82 and became a full partner in 1885. For more than twenty years Hermann Sielcken was the human dynamo that pushed the firm forward into a place of world prominence. He was the best informed man on coffee in two continents; and when, in 1904, the firm name was changed to Crossman & Sielcken—W. H. Crossman having died ten years before—he was well prepared to assert his rights as king of the trade. He proved his kingship by his masterful handling of valorization three years later.

Sielcken was many times credited with working "corners" in coffee; but he would never admit that a corner was possible in anything that came out of the ground; and to the end, he was insistent in his denials of ever having cornered coffee. As a daring trader, he won his spurs in a sensational tilt with the Arbuckles in the bull campaign of 1887. Because of this, he became one of the most feared and hated men in the Coffee Exchange. For a while, coffee did not offer enough play for his tremendous energy and ambition. He embarked in various enterprises—among them, the steel industry and railroads. No one was too big for Sielcken to cross lances with. He bested John W. Gates in a titanic fight in American Steel and Wire. He quarreled with E. H. Harriman and George J. Gould over the possession of the Kansas City, Pittsburgh, and Gulf Railroad, now known as the Kansas City Southern, and, backed by a syndicate of Hollanders, obtained control. While still busy with the Kansas City Southern enterprise Sielcken began work on the coffee valorization scheme that he carried to a successful conclusion in spite of the law of supply and demand and the interference of the Congress of the United States. Valorization by the São Paulo government, and by coffee merchants, having proved a failure, Sielcken showed how it could be done with all the American coffee merchants eliminated—except himself. In this way, he secured for himself the opportunity he had long been seeking—the chance to bestride the coffee trade like a colossus.

When his partner, George W. Crossman, died in 1913, it was discovered that the two men had a remarkable contract. Each had made a will giving one million dollars to the other. Then Sielcken bought his late partner's interest in the firm for \$5,166,991.

His first wife having died at Maria-

halden, his home in Baden-Baden, seven years before, Sielcken married at Tessin, Germany, in 1913, Mrs. Clara Wendroth, a widow with two children, and the daughter of the late Paul Isenberg, a wealthy sugar planter of the Hawaiian Islands. At that time the coffee king was dividing his time between the Waldorf-Astoria, New York, which he called his American home, and his "show" estate in the fatherland. The latter was a two-hundred-acre private park containing four villas and a gorgeous bath-house for guests besides the main villa; a rose-garden in which were cultivated one hundred sixty-eight varieties on some twenty thousand bushes; a special greenhouse for orchids; and landscaped grounds calling for the service of six professional gardeners and forty assistants. Here he delighted to entertain his friends. Frequently, there were fifteen to twenty of them for dinner on the garden terrace; and, as the moon came up through the tall hemlocks and shone through the majestic pines brought from Oregon, a full military band from Heidelberg, adown the hillside among the rose trees, mingled its music with the dinner discussions. There was nothing at that dinner table but peace and harmony, although every language in Europe was spoken; for Sielcken knew them all from his youth. Sometimes he entertained his guests with stories of his California life, and sometimes with those of shipwrecks in South America.

All the post-telegraph boys in Baden knew every foot of the sharply winding road up the Yburg Strasse to Villa Mariahalden; and the guests therein have counted more than eighty cables received, and more than thirty sent in a single day. And those daily cable messages were to and from all quarters of the globe, and to and from the master, who handled them all, without even a secretary or typewriter. Nowhere in the entire establishment was there even an appearance of business, except as the messages came and went on the highway. Sielcken found his greatest delight in showing his friends his orchids, his roses, his pigeons, his trout, and his trees.

Like Napoleon, this merchant prince required only five hours sleep. It was his custom to go to bed at one and to be up at six. Did he wish to know anything that the cables did not bring him, he jumped into his eighty-horse-power Mercedes with a party of guests and was off with the sun-

rise, down the Rhine Valley, on his way to Paris or Hamburg; and before one realized that he was gone, he was back again.

In 1913, Sielcken admitted to partnership in his firm two employees of long service, John S. Sorenson and Thorlief S. B. Nielsen. He went to Germany in 1914, shortly before the beginning of the World War, and remained at Mariahalden until he died in 1917. Sielcken never would believe that war was possible until it had actually started. Up to the last moment in July, 1914, he was cabling his New York partner that there would probably be no hostilities. He lost a bet of a thousand pounds made with a visiting Brazilian friend a few days before war was declared. The guest believed war inevitable and won. A few days before Sielcken's death the old firm was dissolved under the Trading with the Enemy Act, being succeeded by the firm of Sorenson & Nielsen. The former had been with the business thirty-four years, and the latter thirty-two years. The alien property custodian took over Sielcken's interest for the duration of the war.

Rumors in 1915 that the German government was extorting large sums of money from Sielcken brought denials from his associates here. After the war, it was confirmed that no such extortions took place.

Sielcken always claimed American citizenship. There was a widely circulated story, never proved, that he tore up his citizenship papers in 1912 when the United States government began its suit to force the sale of coffee stocks held here under the valorization agreement. The Supreme Court of California in 1921 decided that he *was* a citizen, and his interests and those of his widow, amounting to \$4,000,000, held by the alien property custodian, were thereupon released to his heirs. It appeared in evidence that he took out his citizenship papers in San Francisco in 1873-74, but lost them in a shipwreck off the coast of Brazil in 1876. The San Francisco fire destroyed the other records; but under an act of legislature re-establishing them, the citizenship claim was declared valid.

Hermann Sielcken never liked the title of "coffee king." He was once asked about this appellation, and turned smartly upon the interviewer.

"Nonsense," he said. "I am no king. I don't like the term, because I never heard of a 'king' who did not fail."

Sielcken had no use for titles. T. S. B.

Nielsen once told of a dinner party in Germany in 1915 at which he heard Sielcken explain to a large number of guests that the United States was the best country because there a man was appraised at his real value. What he did, and how he lived, counted—not birth or titles.

While his greatest achievement was, of course, the valorization enterprise, he played a not unimportant rôle in the Havemeyer-Arbuckle sugar-trust fight. He aided the late Henry O. Havemeyer to secure control of the Woolson Spice Co. of Toledo in 1896, so as to enable the Havemeyer's to retaliate with Lion brand coffee for the Arbuckles' entrance into the sugar business. The Woolson Spice Co. sold the Lion brand in the middle west, and the American Coffee Co. sold it in the east. That was the beginning of a losing price-war that lasted ten years. At the end, Sielcken took over the Woolson property at a price considerably lower than originally paid for it. In 1919, the Woolson Spice Co. brought suit against the Sielcken estate, alleging a loss of \$932,000 on valorization coffee sold to it by Sielcken just after the Federal Government began its suit in 1912 to break up the valorization pool in the United States. The Woolson Spice Co. paid the "market price," as did the rest of the buyers of valorization coffee; but it was charged that Sielcken, as managing partner of Crossman & Sielcken, sold the coffee to the Woolson Spice Co., of which he was president, "at artificially enhanced prices and in quantities far in excess of its legitimate needs, concealing his knowledge that before the plaintiff could use the coffee, the price would decline." Sielcken collected \$3,218,666 for the coffee sold.

When the United States government crossed lances with Sielcken in 1912 over the valorization scheme, it looked for a time as if he would be unhorsed. But men and governments were all the same to Sielcken; and at the end of the fight it was discovered that not only was he undefeated—for the Government never pressed its suit to conclusion—but that his prestige as king and master mind of the coffee trade had gained immeasurably by the adventure.

Hermann Sielcken typified German efficiency raised to the nth power. He was a colossus of commerce with the military alertness of a Bismarck. His mental processes were profound, and his vision was far-reaching. He was a resourceful trader,



an austere friend, a shrewd and uncompromising foe. Physically, he was a big man with a bull neck and black, piercing eyes. His policy in coffee was one of blood and iron. He brooked no interference with his plans, and he was ruthless in his methods of dealing with men and governments. Usually silent and uncommunicative, occasionally he exploded under stress; and when he did so, there was no mincing of words. He knew no fear. Newspaper criticism annoyed him but little; and he had a kind of contempt for the fourth estate as a whole, although he knew how to use it when it suited his purpose. He avoided the limelight, and never courted publicity for himself. Socially he was a princely host; but few knew him intimately, except perhaps in his native Germany.

Sielcken's widow was married in New York, February 11, 1922, to Joseph M. Schwartz, the Russian baritone of the Chicago Opera Company.

#### *The Story of John Arbuckle*

John Arbuckle, for nearly fifty years the honored dean of the American coffee trade, pioneer package-coffee man, some time coffee king, sugar merchant, philanthropist, and typical American, came from fine, rugged Scotch stock. He was the son of a well-to-do Scottish woolen-mill owner in Allegheny, Pa., where he was born, July 11, 1839. He



Mr. John Arbuckle

often said he was raised on skim milk. He received a common school education in Pittsburgh and Allegheny. He and Henry Phipps, the coke and steel head, are said to have occupied adjoining desks in one of the public schools, Andrew Carnegie being at that time in another grade of the same school. He had a strong bent for science and machinery; and, although he chose the coffee instead of the steel business for his career, the basis of his success was invention. He also attended Washington and Jefferson College at Washington, Pennsylvania.<sup>1</sup>

<sup>1</sup> Much of the information that follows is from an article by M. E. Goetzinger in the *Percolator*, February, 1921.

The Arbuckle business was founded at Pittsburgh, in 1859, when Charles Arbuckle, his uncle Duncan McDonald, and their friend William Roseburg, organized the wholesale grocery firm of McDonald & Arbuckle. One year later John Arbuckle, the younger brother of Charles Arbuckle, was admitted to the firm, and the firm name was changed to McDonald & Arbuckles. McDonald and Roseburg retired from the firm a few years later, leaving the business in the hands of the two youthful, hopeful, and energetic brothers, who under the firm name of Arbuckles & Co., soon made their firm one of the important wholesale grocery houses in Pennsylvania. Although little thinking at the time that their greatest success was to be achieved in coffee, and that a new idea of one of the partners—that of marketing roasted coffee in packages—would make their name familiar in every hamlet in the country, yet the first two entries in the original day-book of McDonald & Arbuckles record purchases of coffee.

Prior to the 'sixties, coffee was not generally sold roasted or ground, ready for the coffee pot. Except in the big cities, most housewives bought their coffee green, and roasted it in their kitchen stoves as needed. John Arbuckle, having become impressed with the wasteful methods and unsatisfactory results of this kitchen roasting, had already begun his studies of roasting and packaging problems, studies that he never gave up. How first to roast coffee scientifically, and then to preserve its freshness in the interval between the roaster and the coffee pot, continued to be an absorbing study until his death. The range of his work may be illustrated by reference to his first and his last patents. In 1868, he patented a process of glazing coffee, which had for its object the preservation of the flavor and aroma of coffee by sealing the pores of the coffee bean. Thirty-five years later, he patented a huge coffee roaster in which, more closely than in any other roaster, he felt he could approach his ideal of roasting coffee—that ideal being to hold the coffee beans in suspension in super-heated air during the entire roasting process, and not to allow them to come in contact with a heated iron surface.

By 1865, John Arbuckle had satisfied himself that a carefully roasted coffee, packed while still warm in small individual containers, would measurably overcome the

objections to selling loose coffee in a roasted state. So in that year (1865), although not without the misgivings of his elder brother, and even in the face of the ridicule of competitors, who derided the plan of selling roasted coffee "in little paper bags like peanuts," Arbuckles & Co. introduced the new idea, namely, roasted coffee in original packages. The story of the development of that simple idea, which soon spread from coast to coast, and of how it laid the foundations of a great fortune, is one of the romances of American business.

Although Osborn's Celebrated Prepared Java Coffee, a ground-coffee package, first put on the New York market by Lewis A. Osborn, and later exploited by Thomas Reid in the early 'sixties, appears to have been the original package coffee, much of the fame attached to the name of Arbuckle comes from its association with the Ariosa coffee package, which was the first successful national brand of package coffee. It was launched in 1873. The Ariosa premium list (premiums have been a feature of the Arbuckle business since 1895) includes a hundred articles. Almost anything from a pair of suspenders or a toothbrush, to clocks, wringers, and jewelry may be obtained in exchange for Ariosa coupons.

The name "Ariosa" is said to have been arbitrarily coined, though it is not known what considerations prompted it. One story has it that the "A" stands for Arbuckle, the "rio" for Rio, and the "sa" for South America or Santos; Rio and Santos coffees having formed component parts of the original blend.

Early in the 'seventies, the great business opportunities of New York City had attracted the two brothers, and a branch was established in New York in charge of John Arbuckle, the main business in Pittsburgh being left in the care of his brother Charles. The growth of the New York branch soon made it necessary for Charles Arbuckle to leave the Pittsburgh business in charge of trusted employees, and to come to New York. In time, the coffee business of the New York house overshadowed the grocery lines; and the latter were abandoned there, so that the entire energy of the firm in New York might be devoted to the coffee business, which thenceforth was operated under the firm name of Arbuckle Bros. The Arbuckle coffee business, which began with a single roaster in 1865, had eighty-

five machines running in Pittsburgh and New York in 1881.

Charles Arbuckle died in 1891, and John Arbuckle admitted as partners his nephew, William Arbuckle Jamison, and two employees, William V. R. Smith and James N. Jarvie, the business continuing under the former name of Arbuckle Bros. The most important step taken by the firm while thus constituted was its entrance into the sugar refining business in 1896. That entrance had to be forced against the bitterest opposition of a so-called sugar trust, and brought on a "war" signalized by the most ruthless cutting of prices of both coffee and sugar. This war was costly to both sides; but when it had ended, Arbuckle Bros. remained unshaken in the pre-eminence of their package-coffee business and had acquired also great publicity and a fine trade in refined sugar.

Arbuckles were always large consumers of sugar in connection with their coffee glaze, and having introduced the package sugar idea with their customers some years before, they at last made up their minds to refine for their own needs and thus to save the profits paid to "the Havemeyers." It is generally conceded that John Arbuckle's shrewdness and business sagacity in having previously acquired the Smyser patents on a weighing and packing machine, and his control of it, really led to the coffee-sugar war. "This packing machine," said Jabez Burns's *Spice Mill*, when Henry E. Smyser died in 1899, "puts him [Smyser] with the greatest inventors of our day."

The sugar trust met the Arbuckle challenge by invading the coffee-roasting field. This they accomplished by securing a controlling interest for \$2,000,000 in one of the largest competing roasting plants in the country, that of the Woolson Spice Co., of Toledo, Ohio, that had in the Lion brand, a ready-made package coffee wherewith to fight Ariosa. The re-organization of the Woolson Spice Co. in 1897, when A. M. Woolson was relieved of the office of president, disclosed, among others, the name of Hermann Sielcken in close juxtaposition to that of H. O. Havemeyer on the board of directors. Both men helped to make coffee-trade history.

The trade found the coffee-sugar war the all-absorbing topic for several years. Hot debates were held on the question as to whether, on one hand, the Arbuckles had the right to enter the sugar-refining busi-

ness and, on the other, as to whether the sugar-trust had a right to retaliate. The answer seemed to be "yes" in both instances.

In two years, John Arbuckle's model sugar refinery in Brooklyn was turning out package sugar at the rate of five thousand barrels a day. The Woolson Spice Co. was credited with spending unheard-of sums of money in advertising Lion brand coffee. The eastern newspaper displays alone exceeded anything ever before attempted in this line. However, many people are of the opinion that it was a tactical error on the part of the sugar interests to spend so much money advertising a Rio coffee in the central and New England states, while John Arbuckle was confining his activities to the south and the west, where there already existed a Rio taste among consumers.

The legal fight which the Arbuckles carried on with the Havemeyers for the control of the sugar business in this celebrated coffee-sugar war is said to have cost millions on both sides.

Eventually, the Havemeyers were glad to be relieved of their coffee interests, but John Arbuckle continued to sell both coffee and sugar.

Mr. Arbuckle married Miss Mary Alice Kerr in Pittsburgh, in 1868. She died in 1907. His many charities included boat trips for children, luxurious farm vacations for tired wage-earners, boat-raising and life-saving schemes, a low-priced home for working girls and men on an old full-rigged ship lying off a New York dock, which he called his "Deep Sea Hotel," and a vacation enterprise for young men and young women at New Paltz, Ulster County, N. Y., which was known as the "Mary and John Arbuckle Farm." A magazine for children, called *Sunshine*, was another benevolent enterprise of his.

When John Arbuckle died at his Brooklyn home, March 27, 1912, he had been ill only four days. The New York Coffee Exchange closed at two o'clock the day following, after adopting appropriate resolutions and appointing a committee to attend the funeral. His estate in New York was valued at \$33,000,000.

W. V. R. Smith and James N. Jarvie retired from the firm in 1906; and John Arbuckle and his nephew W. A. Jamison continued as sole owners and partners until Mr. Arbuckle's death in 1912. Mr. Arbuckle died childless and a widower, leav-

ing as his only heirs his two sisters, Mrs. Catherine Arbuckle Jamison and Miss Christina Arbuckle. Mrs. Jamison was the widow of the late Robert Jamison, who had been a prominent drygoods merchant in Pittsburgh. William A. Jamison was her eldest son. Following the death of John Arbuckle, a new partnership was formed in which Mrs. Jamison, Miss Arbuckle, and Mr. Jamison became the partners and owners. Since the subsequent deaths of Mrs. Jamison, Miss Arbuckle and Mr. Jamison, the partnership has been continued by the Misses Jamison, nieces of Mr. Arbuckle. Probably there is no other mercantile establishment of similar size in the country that is carried on as a partnership, and none which after more than seventy-five years is so exclusively owned by members of the immediate family of its founders.

The Arbuckle business, as it is today, is John Arbuckle's best monument. All that it is he foresaw; for behind those keen, penetrating eyes, there was wonderful vision. Simple in his tastes; democratic in his dress, in his habits and his speech; he was one of the most approachable of our first captains of industry. Many of the younger generation in the coffee business have found inspiration in contemplating John Arbuckle's achievements. As represented in what has been called "the world's greatest coffee business," these include other package coffees, such as Yuban, Arbuckle's Breakfast, Arbuckle's Drinksum, Arbuckle's Certified Java and Mocha, Arbuckle's Vacuum and Seven Day brands.

*Jabez Burns, Inventor, Manufacturer, and Writer*

Jabez Burns was a person of real importance to the American coffee trade from 1864, when he began manufacturing his improved roaster, until his death, at the age of sixty-two, in 1888. His success depended more on unusual character than unusual ability, although he was really gifted as regards mechanical invention. He loved to acquire practical information, and arrived confidently at common-sense conclusions; and he exercised a wide and helpful influence, because he liked to give expression to opinions that he considered sound and useful.

Mr. Burns was born in London in 1826. The family moved soon after to Dundee, Scotland, and came to New York in 1844. They were people of small means and in-

dependent thinking. The father, William G. Burns, had been more interested in the Chartist social movement than in any settled business activity. An uncle, also named Jabez Burns, became a popular Baptist preacher in London.

The first winter in America found youthful Jabez teaching a country school at Summit, N. J. Then he began in New York (1844-45) as teamster for Henry Blair, a prosperous coffee merchant who attended a little "Disciples" church in lower Sixth Avenue where many Scottish families congregated. There Burns met Agnes Brown, daughter of a Paisley weaver, and married her in 1847. A brave young pair they were, who found all sorts of odd riches—



Mr. Jabez Burns

just as if a fast-growing family could somehow make up for a slow-growing income. There were hopes, too, that the contrivances Burns kept inventing might bring wealth; and some extra money did come from the sale of early patents, including one in 1858 for the Burns

Addometer, a primitive adding machine.

But Mr. Burns had continued regularly in the employ of coffee and spice firms, and at one time he was bookkeeper for Thomas Reid's Globe Mills. He advanced slowly, because he lacked real trading talent; but he was learning all about the handling of goods, from purchase to final delivery; and when he quit bookkeeping for the old Globe Mills, and began to build his patent roaster, he could advise clients reliably about every factory detail.

He was soon looked on as an authority. He wrote some articles for the *American Grocer*, a series on "Food Adulteration" being reprinted; and in 1878, he began the quarterly publication of his thirty-two-page *Spice Mill*, which soon became a monthly, and gained the interested attention of practically the entire coffee and spice trade.

Through the columns of this paper, in circulars, by letters, and in a pocket volume called the *Spice Mill Companion*, he distributed information on coffee, spices, and baking powder, and gave valuable advice to beginners in the coffee-roasting business.

Not a few coffee roasters were started on the way to fortune by the counsel of Jabez Burns. He died in New York, September 16, 1888.

Jabez Burns entered the machinery business in 1864, beginning the manufacture of his patent coffee roaster, at 107 Warren Street, New York, the street sign reading "Jabez Burns, Inventor." Since then, the growth of the business has required four removals. In December, 1908, the business moved to its present uptown location, at the northwest corner of Eleventh Avenue and Forty-third Street, occupying a six-story building which was doubled in size in 1917. This Burns factory has been referred to as "the unique coffee-machinery workshop," the greatest establishment of its kind in the United States.

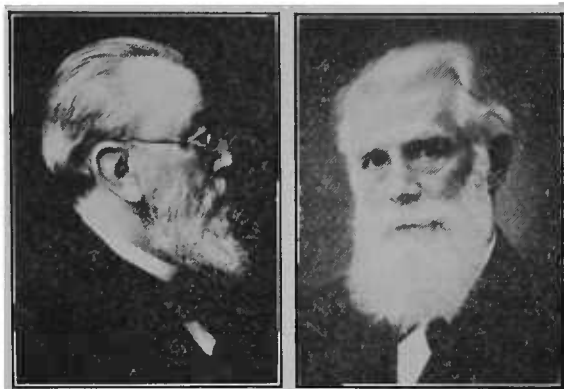
Upon the death of its founder the business was continued; first, as the firm of Jabez Burns & Sons, composed of his sons, Jabez, Robert, and A. Lincoln Burns; and later, in 1906, incorporated as Jabez Burns & Sons, Inc., with Robert Burns as president, Jabez Burns as vice-president, and A. Lincoln Burns as secretary and treasurer. Jabez Burns died August 6, 1908. Robert Burns died November 8, 1929. The present officers are: William G. Burns, president; J. L. Kopf, vice-president; Kenneth Burns, vice-president; Payson MacKaye, secretary, and J. F. Biehl, treasurer.

A. Lincoln Burns succeeded his father as editor of the *Spice Mill*. William H. Ukers was made editor in 1902, and he continued until 1904, when he left to assume editorial direction of *The Tea and Coffee Trade Journal*.

#### *Alexius van Gülpen and Theodor von Gimborn*

In Europe two German names stand out among the pioneers of the coffee machinery business. They are Alexius van Gülpen (1839-1921), a coffee roaster, and Theodor von Gimborn (1840-1916), an engineer. Together they began the manufacture of coffee roasting machines at Emmerich in 1868. Since then some 100,000 machines have been turned out by the Emmericher Maschinenfabrik & Eisengiesserei, about 10,000 of them of one bag or more capacity. The firm's name is best known in connection with the manufacture of the Probat machine.

Numerous patents were taken out by Mr. van Gülpen and Mr. von Gimborn.



Mr. Alexius van Gülpen    Mr. Theodor von Gimborn  
TWO GERMAN COFFEE MACHINERY PIONEERS

Among them was one for the first sample tester introduced in the axle of the rotating drum; another was for a round cooling sieve, equipped with automatic mixers, and still others for a round tip-over cooling sieve, exhaust sieves in ball roasters, and improvements in rapid roasting by coke, gas, or electricity.

In later years Mr. van Gülpen returned to his original trade of coffee roasting but Mr. von Gimborn remained as president of the Emmericher Maschinenfabrik & Eisen-giesserei until his death in 1916. The business is continued by Mr. Carl von Gimborn, son of Mr. Theodor von Gimborn.

#### *Coffee-Trade Booms and Panics*

In the last fifty years there have been many spectacular attempts to corner the coffee markets in Europe and the United States. The first notable occurrence of this kind did not originate in the trade itself. It took place in 1873, and was known as the "Jay Cooke panic," being brought about by the famous panic of that name in the stock market.

As a result of the Jay Cooke failure, it was impossible to obtain money from the banks. Hence buyers were forced to keep out of the coffee market; and as a consequence, the price of Rios dropped from twenty-four cents to fifteen cents in the course of the trading period of one day.<sup>2</sup>

Another interesting development during that year was of foreign origin. A coffee syndicate was organized in Europe, financed by the powerful German Trading

Company of Frankfort, with agencies in London, Rotterdam, Antwerp, and Brazil. For more than eight years this proved to be a highly successful undertaking, largely controlling the principal producing and consuming markets.

As far as the American coffee trade is concerned, the first sensational upheaval took place in 1880-81. This period witnessed the collapse of the first great coffee trade combination in this country—the so-called "syndicate," comprising O. G. Kimball, B. G. Arnold, and Bowie Dash, sometimes known as the "trinity."

The period of high coffee prices, commencing in 1870, had greatly stimulated production in many Mild-coffee producing countries, as well as in Brazil, and as a consequence the syndicate found its burden becoming extremely heavy early in 1880. In January of that year our visible supply amounted roughly to 767,000 bags. While this was reduced to about 740,000 bags in July, the latter likewise proved to be decidedly burdensome, especially as another liberal crop was beginning to move in producing countries. The excessive volume of supplies was especially marked, because distributing trade during the summer was strikingly dull, as the majority of buyers were holding off, in view of the prospective liberal new crops. At that time Java coffee was a big item in American markets, whereas Santos was just about beginning to be a factor.

The syndicate found that it had its hands full supporting the Brazil grades, and hence had to let the Javas go. As a result, the latter, which had sold at twenty-four and three-quarters cents in January, 1880, fell to nineteen and one-half cents in July, to eighteen cents in November and to sixteen cents in December. As a matter of fact, the syndicate was practically the only buyer of Brazil coffee during the fall of 1880; and as a consequence, Rios, which had started the year at fourteen and one-half to sixteen and one-quarter cents, were down to twelve and three-quarters cents in December, 1880, and had dropped nine and one-half cents when the break in the market culminated in June, 1881.

The first whispers of financial troubles growing out of these adverse conditions were heard in October, 1880; and on the 27th of that month the first failure was announced—that of C. Risley & Co., with liabilities placed at \$800,000 and assets at

<sup>2</sup> What follows on "Trade Booms and Panics" is from an article prepared, under the author's direction, by C. K. Trafton, and published in *The Tea and Coffee Trade Journal*, Nov., 1920 (Vol. XXXIX: No. 5: p. 563).



\$400,000. This firm had been doing business in the local market for about thirty years. The efforts of the receivers to dispose of this company's large stock naturally served to accelerate the decline; and the final impetus came on December 6, when the New York trade heard of the death, two days previously, of O. G. Kimball, of Boston, one of the most prominent merchants there. This precipitated the big crash of December 7, when B. G. Arnold & Co., the largest New York firm, suspended with estimated liabilities of \$750,000 to \$1,000,000. The official statement later placed the liabilities at \$2,157,914, and assets at \$1,400,000, of which \$884,198 were secured. Within three days this failure was followed by the suspension of Bowie Dash & Co., with liabilities estimated at \$1,400,000.

For weeks thereafter there was virtually no market. With all of these distress holdings pressing for liquidation, buyers, as was natural, were extremely timid. In the meantime, the import arrivals showed further enlargement at various southern ports, as well as at New York. Total arrivals at this port during 1881 were almost 12,400,000 pounds heavier than for the preceding year. The growing importance of Santos as a market factor was demonstrated by the fact that shipments from there in 1881 were 1,198,625 bags, compared with about 628,900 bags in 1876-77. According to the best informed members of the trade at that time, the losses sustained by the various firms that were forced to the wall aggregated between \$5,000,000 and \$7,000,000.

The utterly demoralized conditions prevailing while this collapse was in progress, and the practical elimination of a market in the true sense of the word, furnished the principal impetus for the organization of the New York Coffee Exchange. At that time, the Havre market was the only one with an exchange. The local body was organized in December, 1881, and started business in March, 1882.

#### *The Cable Break of 1884*

The second noteworthy movement, embracing an advance of four to four and one-half cents and a recession of slightly more than three cents, covered a period of about eight months shortly after the Exchange was organized. Various local and out-of-town firms were interested in the bulge

which carried Rio coffee in this market from about seven cents in July, 1883, up to eleven and one-half cents late in November. By the middle of December, the price had fallen to nine and one-quarter cents, the final break to eight and one-quarter cents occurring late in March of the following year. At that time, there was no direct cable communication with Brazil; and as a result of a temporary break in the roundabout service by way of Portugal, the New York and Baltimore agents of the Brazilian syndicate were unable to put up additional margins in this market, and their accounts were closed out. This happened on a Saturday; and by the following Monday, partial cable remittances arrived and all accounts were settled in full with interest from Saturday to Monday.

#### *The Great Boom*

What is generally described as "the great boom" of the coffee trade occurred in 1886-87, and had its inception in unsatisfactory crop news from Brazil. The crop of 1887-88, it was estimated, would be extremely small; and it turned out to be only 3,033,000 bags. These advices and low estimates led to the formation of a "bull" clique, comprising operators in New York, Chicago, New Orleans, Brazil, and Europe, who set a price of twenty-five cents for December contracts as their goal. Toward the end of June, 1886, when this campaign started, No. 7 Rio in New York was worth about seven and one-half cents, with June contracts on the Exchange quoted at seven and sixty-five hundredths cents. With Brazilian crop news still more discouraging, the advance thereafter was almost continuous, and on June 1, 1887, December contracts sold at twenty-two and one-quarter cents—a new high-price record, that was not exceeded for thirty-two years, when twenty-four and sixty-five hundredths cents were paid for July contracts in June, 1919. After reaching twenty-two and one-quarter cents, prices suffered an abrupt reversal. Ten days later the closing price for December was twenty-one and four-tenths cents. Then the real crash began. On Saturday, June 11, the panic started with another claim of cable trouble; and in the short session, December coffee broke from twenty and fifteen-hundredths to eighteen and sixty-five hundredths cents, closing at a loss for the day of 275 points. The first

sale of December on Monday was at seventeen and four-tenths cents, or 125 points lower; and after numerous erratic variations, the price broke to sixteen cents, a drop of six and one-quarter cents in less than two weeks. Business on that day was of enormous volume, in round numbers 412,000 bags; and approximately \$1,500,000 was put up in margins. For the next three days the decline was temporarily halted, and December, at one time, was up three and one-quarter cents from the bottom (nineteen and one-quarter cents.) On June 17, another battle commenced, December dropping back to seventeen cents. Then came a rally to eighteen and one-tenth cents, a drop to sixteen and one-half cents; another rally to eighteen and one-tenth, and, on June 24, another break to the previous low level of sixteen cents for December. This sharp reversal in less than a month was traceable largely to more favorable news from Brazil, the 1888-89 crop being estimated at 6,827,000 bags.

Following a rally to nineteen and six-tenths cents during the next month (July, 1887), the pendulum again swung downward. The climax came with the culmination of the "European fiasco" of the spring of 1888. Reports were received that various European coffee firms had failed; and future contracts in the American market sold as low as nine cents in March.

#### *A Famous European Bull Campaign*

The next campaign of interest lasted more than two and a half years. In September, 1891, there was a corner in the local market which forced the September price up to seventeen and one-quarter cents. George Kaltenbach, a wealthy speculator living in Paris, combining with three operators in Havre, Hamburg, and Antwerp, succeeded in breaking the corner, forcing the price down to ten and eight-tenths cents. They then changed to the bull side, buying heavily in all markets of the world. This was continued until early in 1893, bringing the price back to fifteen cents. Although his associates then returned to the bear side, Kaltenbach kept on buying; and aided by bad crop reports from Brazil, he worked the price up as high as seventeen and seven-tenths cents. At one time it was said that his profits were more than one million dollars. The collapse of this deal occurred in May, 1893, involving

thirty firms in Hamburg, Havre, and Rotterdam. As Kaltenbach could not keep his large New York holdings margined, they were thrown on the market, bringing about a sharp break, and causing the failure of his New York agents, T. M. Barr & Co.

The present era of large crops began in 1894, Brazil's production for 1894-95 being placed at 6,695,000 bags. Nevertheless, Guzman Blanco, a former president of Venezuela, then living in Paris, and said to be worth about \$20,000,000, attempted to run a corner in April, 1895. He bought 200,000 bags of spot coffee in Havre warehouses and accumulated a big line of futures in various markets. Assisted by reports of cholera in Rio and some reduction in Brazilian crops, he enjoyed temporary success, the price of Rio 7s in New York rising to fifteen and one-half cents in October, 1895. Thereafter, there was an almost continuous decline. In the spring of 1898, a vigorous bear campaign was conducted, largely in the form of market letters; and by November, Rio 7s here had dropped to four and one-half cents.

#### *The Bubonic Plague Boom*

The so-called "bubonic plague boom" halted this prolonged downward movement for a time in 1899-1900. The boom derived its name from the outbreak of bubonic plague in Brazil, as a result of which the ports of that country were quarantined. In addition, Brazilian steamers arriving at New York were placed in quarantine; and the impossibility of unloading their cargoes caused a temporary shortage. As a result, prices rose from four and one-quarter cents in September, 1899, to eight and one-quarter cents in July, 1900. The quarantine being lifted, the bears again became aggressive; and by April, 1901, they had forced the price back to five cents.

There was another short-lived attempt to establish a corner in September, 1901. Receipts at Rio and Santos had been running light, encouraging a local clique embracing Skiddy, Minford & Company; W. H. Crossman & Bro.; and Gruner & Company, to endeavor to gain control. The arrivals at Brazilian ports suddenly increased to the largest volume ever known up to that time; and, with vigorous opposition from operators in Havre, the corner here was speedily broken.

The opening of the new century witnessed the beginning of another new coffee era, Santos permanently displacing Rio as the world's largest source of supply. The figures for 1900-01 were: Santos, 2,945,000 bags; Rio, 2,413,000 bags.

Huge crops then became a regular thing in Brazil. That of 1901-02 was far in excess of estimates, being 15,000,000 bags; while 20,000,000 bags were produced in 1902-03. As a result, the world's coffee trade became completely demoralized for the time being. In August, 1902, contracts for July, 1903, delivery sold at six and one-tenth cents. By June, 1903, they had fallen to three and fifty-five hundredths cents, the lowest price ever recorded for coffee.

#### *The Southern Boom*

As is invariably the case when prices reach extreme levels, either high or low, the pendulum swung back rapidly in the other direction. Based on the unprecedentedly low prices, the so-called "cotton crowd" started what was generally known as "the southern boom." Various cotton traders in New York and the South, under the leadership of D. J. Sully, the one-time "cotton king," and ably assisted by prominent local coffee firms, became extremely active on the buying side; and by February, 1904, they had forced the price up to eleven and eighty-five hundredths cents. This figure, the highest since 1896, was reached on February 2, which proved to be another day of enormous speculative dealings, involving roundly 462,000 bags. This marked another turning point; the three succeeding days of record-breaking operations on the Exchange witnessing a break of roughly two cents. Mr. Sully went on a vacation on February 3, and the Sielcken interests sold on a large scale. Business for that day was placed at 555,000 bags, closing prices being about one-half cent lower. This brought on enormous liquidation by western bulls on the following day, approximately 500,000 bags. As a result, prices lost twenty-five to sixty-five points on a turn-over of about 642,000 bags. All records for business were smashed on the following day, February 5. The official record was 689,000 bags, but trade estimates made it more than 1,000,000 bags. On that day, southern interests liquidated heavily, causing net losses of eighty to ninety points. Doubtless the break would

have been more severe had it not been for buying by the Sielcken people and several other strong interests at and below seven and one-quarter cents for September contracts.

#### *The Story of Valorization*

The valorization, or equalization, of coffee originated in Brazil. When the original plan was threatened with disaster, Hermann Sielcken stepped in and saved the Brazil planters from ruin; the Brazil government from possible revolution; and, incidentally, won for himself and those who were his partners in the enterprise much unenviable notoriety.

The principle of valorization is generally conceded to be economically unsound, because it encourages overproduction. And valorization in Brazil would have been a failure, had it not been for a fortuitous combination of short crops, Hermann Sielcken's genius, and the World War. Because of the lessons learned in this experience, Brazil's subsequent valorization enterprises ran more smoothly.

A rapidly increasing world demand, a wonderfully fertile soil, and cheap labor kept the Brazil coffee industry in a flourishing condition nearly to the close of 1889. Coffee consumption was increasing, especially in the United States. By April, 1890, the average import price per pound of Rio No. 7 in this country was nineteen cents; and Brazil was supplying only about half our needs. Virgin soil was still available in Brazil, and immigration furnished all the needful labor. Easy profits led to increased investment and careless methods. Her planters were drunk with prosperity. For six years, nearly all the three million inhabitants of São Paulo, Brazil's largest coffee producing state, "entirely gave up planting corn, rice, beans, everything they needed. They bought them because coffee was so immensely profitable that they put all their labor in coffee."

Brazil had been going through a period of low exchange. Paper money fell below par. The exaggerated issues of it, which provoked the collapse of exchange, suddenly endowed Brazil with an abundant circulation of money. Production was enormously stimulated. New undertakings sprang up on every hand. Armies of agricultural laborers were recruited in Europe and shipped into the coffee districts. And then, to make the story short, supply passed

demand, surplus stocks began to appear, prices began to fall, and fell until they dropped below the cost of production.

It was in 1896-97, when the new trees came into bearing by the tens and hundreds of thousands, that São Paulo's folly began to tell. By October of that year the price of Rio No. 7 in New York had fallen to about seven cents. The decline continued, until, in 1903, it hung around five cents. Then began the winter of São Paulo's discontent. Too late, the state government tried by taxing new coffee estates, to force the planters to raise crops to supply their own necessities. The times grew harder.

Mortgages held by large coffee houses and bankers were being foreclosed. The industry was passing into European hands. The smaller planters were becoming desperate; and desperation is only a step from revolution. The government of the state of São Paulo knew this; and to save the state, it finally promised it would buy the next coffee crop, and would hold it for the planters at such a price as would be necessary to continue the industry. The protagonists of this plan to valorize coffee were Dr. Jorge Tibiriçá, Dr. Augusto Ramos, and Dr. Albuquerque Lins.

During all the period covering São Paulo's rise and fall in coffee, the financial genius who was to lead her again into the land of plenty had been quietly acquiring a knowledge of her problems—also, the ability to make money out of their solution.

Valorization was undertaken to save the coffee industry. Its intent was good, even if the theory was bad. The scheme was not new, and there were no encouraging precedents to augur its success. The situation was desperate and seemed to justify the trial of a desperate remedy. São Paulo attempted to carry the load; but her resources were insufficient.

The bumper world crop of 19,090,000 bags in 1901-02 was followed, in 1906-07, with another extraordinary yield of 24,307,000 bags, of which Brazil alone produced 20,192,000 bags. To make good its promise to the planters, ready cash was needed; and so the São Paulo government sent a special commissioner to Europe to get it. For sixty years the Rothschilds had acted as Brazil's bankers. The commissioner went to the Rothschilds first. He was flatly refused. After that, he was turned down by practically every bank on the continent. It looked as if the bankers had entered into

a gentlemen's agreement to make it unanimous. Then the commissioner bethought himself of the coffee merchants; and that thought naturally suggested Hermann Sielcken, who, singularly enough, happened to be conveniently resting at nearby Baden-Baden. In August, 1906, the commissioner waited upon Mr. Sielcken and begged his aid.

It was Sielcken's hour of triumph. For years he had been soliciting Brazil. Now the tables were turned, and Brazil was asking favors of Sielcken.

The rest of the story is best told by Robert Sloss, who wrote it for *World's Work* from information furnished by trade authorities—and even by Mr. Sielcken, himself, in various speeches, newspaper articles, and on the witness stand. It is presented here with certain minor corrections by the author:

"Well, what do you want me to do?" asked Hermann Sielcken of the commissioner from the state of São Paulo.

"We want you to finance for us five to eight million bags of coffee," said the commissioner blandly.

Here was an adventure. Here was a proposition to lift bodily out of the market half as much coffee as the world's total production had averaged for the ten preceding years when prices had been so low. Presumably, if this were done, prices would be doubled. But Hermann Sielcken shook his head.

"No," he said, "there is not the slightest chance for it, not the slightest." And then he pointed out that there would be "no financial assistance coming from anywhere" if the São Paulo planters kept on raising such ridiculously large crops of coffee.

The commissioner assured him that the prospect was for smaller crops in future. Hermann Sielcken was not so sure about it. "At a price low enough," he mused, "I might be able to raise funds to pay eighty per cent on a value of seven cents a pound for Rio No. 5."

The commissioner was dismayed. His government had already promised to take coffee from the planters at about a cent a pound above the market, and the market then stood at nearly eight cents. The government would have to dig to make up the difference. Hermann Sielcken's terms were the best that could be got, however, and the commissioner accepted them.

From that time forth Hermann Sielcken was the head of the movement. He approached a few large coffee merchants, including his former rivals, Arbuckle Brothers, and drew up a contract. The merchants agreed to advance eighty per cent of the sum required to buy two million bags of coffee at seven cents a pound. If the market went above seven cents, the government was to make no purchases. If it fell below seven cents, the government was to make good the difference to the merchants by cable.

Before the season was well advanced the unexpected happened. Brazil was reaping the larg-

est coffee harvest in the history of the world. The two million bags of coffee purchased by the government were as a drop in a bucket. Financed by Hermann Sielcken, Schroeder, the great London banker, and a few prominent European merchants, the government was forced to buy almost nine million bags. Toward the end of 1907, the government had lifted half of the world's visible supply of coffee, but the market stood only a trifle above six cents a pound. The government was practically bankrupt.

Hermann Sielcken now enlisted the Rothschilds on his side, and shifted the financial burden from the shoulders of the coffee merchants to those of the Paris bankers and their American associates. Then the Rothschilds imposed their conditions on the government of Brazil. A national law was passed determining a heavy penalty for any one who planted a new coffee tree in Brazil. The government guaranteed that not more than nine million bags of the next coffee crop and not more than ten million bags of any succeeding crop should be exported.

By the end of 1911, the coffee market stood well above thirteen cents. Here was a rise of more than one hundred per cent in two years, more than sixty per cent in six months. Evidently, valorization coffee in the hands of the bankers' committee had become a gilt-edged security. But how?

During the five crop years since the "plan" was launched on the heights above Baden, nearly 90,000,000 bags of coffee had been raised in the world. The bankers' committee still held 5,108,000 bags of this. At the highest estimate, consumption had exceeded production by only 4,000,000 bags. Here was a shortage of only a little more than ten per cent in supply as against demand, so far as crops go. Yet there had been a rise of more than one hundred per cent in two years in the price of coffee on the New York Coffee Exchange. . . Upon the merchant's ability to deliver coffee on the New York Coffee Exchange depends the price of coffee in the world. That explains why the bankers' committee from the beginning refused absolutely to sell valorization coffee on the public exchanges of the world. In Europe, they put it up at auction; and when it didn't go, it was bought in for them. In America, they announced in a printed circular that valorization coffee would be sold only on condition that the purchaser would not deliver it on the New York Coffee Exchange.

Hermann Sielcken absolutely refused to sell coffee to the merchants on the Exchange. Arbuckle Brothers kept on buying coffee heavily, as if they would corner the market. They resold the coffee, however, at private sales, exacting a written contract from the buyer that he would not deliver the coffee on the New York Coffee Exchange, or resell it to any one that would so deliver it. The Coffee Exchange began an investigation, but nothing ever came of it.

Shortly after the valorization committee had apparently cleared up \$25,000,000 in one year, the restriction as to the delivery of valorization coffee on the New York Coffee Exchange was officially removed. Yet neither from Hermann Sielcken nor from Arbuckle Brothers, it is charged, could one buy any coffee to

deliver for that purpose. In 1911, coffee rose to sixteen cents per pound.

At the end, it was found that the committee's holdings had been marketed at the various sales on a basis, for Santos 4s, from eight and five-eighths cents minimum, to the final sale here forced by the United States government, at which time the price realized was sixteen and three-quarter cents for Santos 4s, and fourteen cents for Rio 7s.

The one fly in the valorization ointment was Senator G. W. Norris, of Nebraska, who early in 1911 called for a congressional investigation of the operations of the valorization syndicate, which he said was costing the American people \$35,000,000 a year. The attorney-general was instructed to report as to whether or not there was a coffee trust. It was a leisurely investigation, which encountered many snags placed in its way by those who believed it would be against international policy to question too closely the participation of the Brazil government in the enterprise. Politics played no inconsiderable part in the investigation, which dragged along until May 18, 1912, when an action was begun in the Federal District Court for the southern district of New York, alleging conspiracy in restraint of trade on the part of Hermann Sielcken; Bruno Schroeder, of J. Henry Schroeder & Co.; Edouard Bunge; the Vicomte des Touches; Dr. Paulo da Silva Prado; Theodor Wille; the Société Generale; and the New York Dock Co.; also praying for injunction and receivership of the valorization coffee then stored in the United States, and amounting to 746,539 bags. The injunction was denied.

Immediately thereafter, rumors began to circulate that the government's coffee suit would never be tried. The Brazilian ambassador threatened diplomatic interference, and Attorney-General Wickersham let it be known that a friendly settlement might be effected. Sielcken boldly challenged the authorities to prosecute the case, and even seemed to invite criminal proceedings against himself. Saving the government's face, and Brazil's face, at one and the same time, proved to be a long and tedious process.

Meanwhile, Senator Norris introduced in Congress a bill designed to give the government power to seize importations of coffee when restraint of trade was proved. It was vigorously opposed by many prominent



green-coffee men and roasters; but in February, 1913, it became enacted into a law. It effectively killed all future valorization schemes in so far as direct participation by this country is concerned.

About December 1, 1912, Attorney-General Wickersham accepted good-faith assurances from Mr. Sielcken's attorney—who represented also the Brazil government—and agreed that if the valorization coffee stored here was sold to bona-fide purchasers before April 1, 1913, the government's suit would be dismissed. In May, 1913, the attorney-general of the new Wilson administration, which came into office in March of that year, issued a statement saying that, good-faith assurances having been received from the Brazil government that the understanding was fulfilled in letter and spirit before the date set by the previous attorney-general, and the entire amount of coffee disposed of to eighty dealers in thirty-three cities, the suit would be dismissed.

In the United States Senate about the same time, Senator Norris renewed his attack on "the international coffee trust." He charged that the coffee sale was not as represented, but merely a transfer, and called upon the Department of Justice for the facts, with names of the alleged purchasers.

Attorney-General McReynolds, on May 7, 1913, declined to send to the Senate the official correspondence in regard to the Brazil coffee-valorization matter, because it was "incompatible with the public interests." He did, however, send other papers on the subject. The secretary of state sent copies of some correspondence; but the documents were not made public. This ended the matter, although Senator Norris called for a congressional investigation, charging that the attorney-general had been handed a "gold brick."

Sielcken contented himself with remarking that the suit was a mistake in the first place, and that it was a foregone conclusion the Government would be defeated. Also, he offered \$5,000 to any one who could explain the Norris bill.

Valorization, then, was started by the state of São Paulo in 1905, when a law was passed authorizing the state to enter into an agreement with the other Brazil states and the federal government for the adoption of measures which would assure the valorization of coffee and facilitate a propaganda abroad for increased consumption.

The states of São Paulo, Minas Geraes, and Rio de Janeiro proposed, early in 1906, to withdraw from the markets such quantities of coffee as would keep down exports and maintain profitable prices. The plan comprehended the interested states borrowing about \$75,000,000 from European and United States bankers with which to buy up the surplus coffee. To take care of interest and amortization, a tax of three francs per bag of 132 pounds (about 57 cents) was to be levied on all coffee exports, collectable at Santos and Rio de Janeiro. Further coffee-planting was to be checked by enforcing the law which carried a tax sufficiently high to operate toward restriction.

When it was understood that Brazil's federal government would not endorse the plan *in toto*, it was abandoned by Rio de Janeiro and Minas Geraes. However, the state of São Paulo in the course of the next two years borrowed some \$30,000,000 on its own account for valorization purposes, obtaining half the amount direct from foreign banking interests, and the remainder through the Brazilian federal government, from London sources.

This first valorization was abandoned in favor of the Sielcken plan, which the federal government ratified in July, 1908. By this new plan São Paulo borrowed \$75,000,000 from the syndicate composed of American, English, German, French, and Belgian bankers. Out of this it repaid the \$30,000,000 loan. The 1908 loan was to expire in ten years, in 1919. Under the plan of the new loan, it was agreed that certain amounts of the valorized coffee should be stored as collateral in warehouses in New York and Europe in charge of a committee of seven, who were authorized to sell the coffee in the market in specified quantities and at prices that would not disturb the price of other coffees. The composition of the committee was as follows: Dr. Francisco Ferreira Ramos, of São Paulo and Antwerp; who was succeeded by Dr. Paulo da Silva Prado; the Vicomte des Touches, of Havre; the Société Generale, of Paris; the firm of Theodor Wille, of Hamburg; Hermann Sielcken, of New York; Edouard Bunge, of Antwerp; and Baron Bruno Schroeder, of J. Henry Schroeder & Co., of London.

Brazil agreed to purchase 10,000,000 bags and to hold them off the market until conditions warranted their sale. It was also

agreed that the total exports of unvalorized stocks from Brazil would be restricted to 10,000,000 bags for 1907-08, and to 10,500,000 bags for 1909-10. In addition, a surtax of five francs gold per bag (96¼ cents) was placed on every bag exported to pay carrying charges. The management of the Government's holdings was placed in the hands of the international committee. This committee issued bonds which were quickly subscribed for; and because of its efficient handling of its huge holdings, prices held steady in spite of the record-breaking Brazilian crop of nearly 20,192,000 bags in 1906-07, and a later one in 1909-10 of about 15,000,000 bags. Indeed, there was an advance of about ten dollars a bag between 1904 and 1911.

Valorization had the effect of stabilizing the Brazil market, and giving the planters and allied interests the assistance they needed to ward off the disaster that threatened them through overproduction. The United States government action in 1912 forced the sale of the valorized stocks held in this country, and the Congress passed the law making it impossible again to offer for sale in America stocks of coffee held under similar valorization agreements.

The coffee situation became so serious in 1913, that São Paulo again entered the money market for another loan, borrowing \$37,500,000 through the good offices of the Brazilian federal government, following this up two years later with another loan of \$21,000,000. According to a semi-official statement issued in Brazil early in 1919, the status of valorization at that time was that the first loan of \$75,000,000 of 1908, had been entirely liquidated, and the two later loans were greatly reduced. At the same time, it was announced by the president of the state of São Paulo that the surtax of five francs would be withdrawn as soon as the liquidation of the loans had been completed. This surtax, however, is still in effect. In 1919, the São Paulo government proposed advancing the *pauta*, or export duty, very materially. A strong protest was made by all the exporters; and a compromise was at last effected by which the proposed increase in the *pauta* was canceled, and the existing surtax of five francs per bag continued as an offset.

The valorization project just described was the second of its kind, a former attempt having proved a failure. At that time

(1870), the Brazilian government had been a large purchaser of Rio coffee, buying it in lieu of exchange, as it had large remittances to make. The coffee was sold through G. Amsinck & Co., and it is believed that heavy losses were sustained.

Since the Sielcken valorization enterprise, the Brazilian government has promoted two more valorizations, one in 1918, another early in 1922. During the latter the Federal Government established a permanent defense of coffee by retaining stocks in interior warehouses. This program was taken over by the state of São Paulo in 1924, but again reverted to the Federal Government in 1930. In 1933 the DNC (Departamento Nacional do Café) assumed control of all coffee in Brazil.

#### *War-Time Government Control of Coffee*

The board of managers of the New York Coffee and Sugar Exchange, Inc., realized, late in 1917, that war-time government control of coffee trading was likely in view of the government's activities in other commodities. To guard against the danger of a sudden announcement of such action, the president of the Exchange was empowered from month to month, at each meeting of the board, to suspend trading at any time that conditions warranted; so that, when President Wilson announced, on January 31, 1918, that all dealers in green coffees were to be licensed, the Exchange was fully prepared. Trading was suspended pending further information, and, owing to the far-sightedness of the board of managers, all danger of a panic in the market was averted.

By 1917, the allies had stopped shipments of coffee to Germany through neighbors who had been her sole source of supply. Stocks in all the producing countries were accumulating, and São Paulo had embarked on another valorization scheme to protect her planters. The markets of Europe were entirely controlled by the governments; and the United States was practically the only free and open market. The market here was steady and without particular animation, and showed none until the end of November, 1917. At that time, speculation activities, steamer scarcity, and the steady advance in freights, became decided influences in the market; and prices began to advance.

Freights on shipments from Brazil had advanced from one dollar and twenty

cents per bag early in the year to unheard-of prices; and, before the bubble burst, had reached as high as four dollars per bag. With this steadily advancing freight, speculation in coffee became more active; and prices naturally began to rise. The relative cheapness of coffee compared with all other commodities; the fact that coffee here had shown very little advance; the prospect of an early peace; the large European demand to follow; were favorite bull arguments. The market became excited; speculative buying was general; every one, apparently, wanted to buy coffee; and twenty cents per pound for Santos 4s in the near future was a common prediction.

The United States food administrator had shown his antipathy to uncontrolled exchange operations by his action on sugar, wheat, corn, and other commodities, dealt in on the exchanges; consequently, the proclamation of President Wilson regarding coffee was not a surprise to those who had been watching the situation closely, especially as on January 30, 1918, the day before the proclamation, the president of the Coffee Exchange was summoned by telegraph to appear in Washington to discuss ways for a proper control of the article, and the best means to bring about such control. As a result of this summons, a committee of the entire trade, representing the Exchange, the green-coffee dealers and importers, the roasters, and the brokers, was appointed by the Exchange to confer with the food administrator at once, in order to work out a plan whereby the business could be kept going. After a long conference, rules agreed upon were approved that became the basis on which business was conducted until the withdrawal of all regulations regarding coffee in January, 1919. Much trade criticism followed the publication of some of these rules.

George W. Lawrence, president of the New York Coffee and Sugar Exchange, was called to Washington on February 28, 1918, to take charge of a newly created coffee division under Theodore F. Whitmarsh, chief of the distribution division of the food administration. In this position he rendered a signal service to the trade and to his country. Although subjected to a cross-fire of criticism from many green and roasted coffee interests, he never wavered in the performance of his full duty; and his good judgment, tact, and loyalty to Amer-

ican ideals, won for him a high place in the regard of all those who had the best interests of the country at heart. He was ably assisted in his work by Walter F. Blake, of Williams, Russell & Company, New York; and by F. T. Nutt, Jr., treasurer of the New York Coffee and Sugar Exchange. A coffee advisory board was appointed in June 1918, to serve as a go-between for the trade and the food administration.

The visible supply of coffee for the United States on January 1, 1918, was 2,887,308 bags. The world's visible supply was given as 10,012,000 bags; but to be added to this were more than 3,000,000 bags held by the São Paulo government. Thus there was little reason to fear a coffee shortage. That coffee should be permitted, (with this large amount in view) to run wild as to price, was certainly not the intention of the food administrator, whose purpose was to keep foods moving to the United States forces and allies, and as far as possible, to keep reasonable prices for the United States consumers. Steadily advancing prices of foods meant increasing cost of labor, general unrest, and a difficult situation to meet at a period when the situation as a whole was most critical.

Trouble for the coffee trade was imminent early in 1918, when the U. S. Shipping Board, backed by experts, decided, or attempted to decide, that coffee was not a food product; that no vessels could be had for its transportation; and that it must be put on the list of prohibited or restricted commodities. Secretary of Commerce Hoover, however, insisted that coffee was a very necessary essential, and that tonnage must be provided for an amount sufficient at all times to keep the visible supply for the United States up to at least 1,500,000 bags of Brazil coffee; and this figure was ultimately accepted by the Shipping Board.

The last week in June brought very cold weather in São Paulo, and cables reported heavy frost. The news was not taken seriously by the trade at large. "Frost news" from Brazil was no novelty, and in the past always had been looked upon as a regular and seasonable method of bulling the market. This year, however, the frost was a fact, and the market began to move upward with surprising speed. Reports of the damage to the trees varied from forty to eighty per cent. Quotations from Santos advanced two cents per pound in as many

days. United States buyers were not disposed to follow the advance; offerings of steamer room were declined; and boats booked for coffee, owing to the lack of cargoes, were transferred elsewhere. Meanwhile the market continued to advance rapidly. The allies were holding the enemy, and peace prospects were brighter. From September 1 to November 15, the records of the Food Administration showed very small purchases. The buyers did not believe in the frost. With the news of the armistice, Brazil markets went wild; and Santos 4s, which had sold at eight and one-quarter cents in May, were quoted at twenty and one-half cents by December 10.

The Food Administration had decided, on February 6, 1918, after consulting the committee appointed by the Exchange, and on their advice and recommendation, to permit trading in futures on the following plan: a fixed maximum price of eight and one-half cents per pound for the spot month, with a carrying charge not to exceed fifteen points per pound for delivery for each succeeding month. Thus the price for March delivery was fixed at eight and one-half cents, while July delivery could be sold at nine and one-tenths cents; but when July arrived, it became the spot month, and eight and one-half cents was the maximum at which it could be sold.

This rule effectively stopped speculation, but failed to work out satisfactorily for the trade. Experience proved that a maximum fixed price at which coffee could be traded in would have produced much better results. Business on the Exchange followed its usual course, and the customary hedging of purchases was done by dealers. The indifference of buyers, already referred to, had resulted in a heavy decrease of the United States visible supply; and it had shrunk to 2,445,000 bags on September 1; to 2,173,098 bags on October 1; to 1,857,260 bags on November 1. Included in these amounts were at least 500,000 bags, held in New York by foreign owners, which could not be sold; and of the balance left, there was undoubtedly a liberal amount sold against on the Exchange for future delivery. By October, the situation had become acute. Dealers who had classified themselves as jobbers or importers had gone into the retail classification in order to evade the limitations of profit allowed jobbers, and were limiting their sales to lots of twenty-five bags or fewer. Dealers who

had legitimately hedged their holdings were unable to buy in.

The Exchange officials showed no disposition to relieve the situation; and as all prices had reached the maximum price permitted each month, the Food Administration, on November 1, 1918, ordered the liquidation of all contracts outstanding, bought or sold, by not later than November 9. This was done; and the coffee covered by such contracts was released to the trade.

The regulations governing transactions on the Exchange were withdrawn on December 5, 1918; and, after a long argument, the Exchange decided to reopen for trading on December 26, 1918. Opening transactions amounted to 25,000 bags on a basis of seventeen and one-half cents per pound or nine cents over the prices at which contracts had been liquidated. On December 28 the price had declined to fifteen and one-half cents. In the opinion of many of our best merchants, the Exchange should have been closed during the war, as it failed to be of any real service. That it was operating at a fixed price for the spot month only, made it of no value to the trade during this period. Of its loyalty to the government, and its evident desire to assist there can be no question; but its cheerful acceptance of the burdens laid upon it proved largely futile.

The action of the Food Administration in confining the coffee business solely to licensed dealers and to a fixed profit on actual cost; in limiting dealers to ninety days stock; and in prohibiting resales, was the cause of much unjust criticism. The regulations were based on the general rules of the Food Administration, and applied to coffee quite as equitably as did the regulations governing other food commodities under control and license. As a matter of fact, they were much less rigorous in some ways than the regulations applying to many other articles. For example, ninety-days stock based on sales for 1916-17 was allowed on coffee. There was no other article on the food list to which this liberality was permitted. A forty to sixty-days stock of other food products would probably be found to be the maximum permitted to be carried.

The general proclamation of the Food Administration of November 1, 1917, declared:

These general and special rules and regulations are promulgated by the President to ac-

comply with three principal objects, viz.: 1st, to limit the prices charged by every licensee "to a reasonable amount over expenses and forbid the acquisition of speculative profits from a rising market"; 2d, to keep all food commodities moving in as direct a line as possible and with as little delay as practicable to the consumer; 3d, to limit as far as practicable contracts for future delivery and dealing in future contracts.

From the foregoing it will be apparent that a profit to be allowed based on "market value" for coffees was an impossibility, unless this law had been altered to allow all licensees of other commodities to share. Coffee profits were fixed by the food administration on the advice of, and with acceptance by, the coffee committee. They started too low; and were made more liberal, when the first figures were shown to be impossible. George W. Lawrence reports a conversation he had with the Food Administrator on this particular subject, which was characteristic of his broadness. Mr. Hoover said, "The coffee dealers are complaining of the profits permitted them. I want them satisfied; and if the profits are not reasonable, I shall put them where they will be. This war is not going to last always; and at its conclusion I want every American merchant in a position to be able to continue his business and be no worse off than when the war started."

Resales were prohibited, or limited to one transaction, in order to prevent an accumulation of profits, that, added to each transfer, would result ultimately in higher prices to the consumer.

The fixing of profit based on cost, and not on market or replacement value, is a thing that is impossible in normal times. Carried to the last degree, it would mean ruination; for no provision is made for declines in the market, and resulting losses. As a war measure it was inevitable, and so endured. In normal times it is like trying to make water run uphill. With a united people, it worked; but one cannot have a World War always to unite the people. It has been said that government regulation of coffees caused a large increase in price to the consumer. This would be hard to prove. The trade, generally, that refused to buy at ten to twelve cents per pound because it did not, or would not believe the reports of frost damage, and thought prices too high, was frantically bidding up to twenty and twenty-two cents for 4s in March and April, 1919. According to the ideas of some enthusiasts, fifty cents was

not an impossibility. Naturally, such a bubble must burst eventually. Government control had nothing to do with such natural conditions as frost, or as the buyers' indifference. Expansion and inflation were in the air, and had to run their course. The year 1920 brought the aftermath; and in the deflation, coffee, with all other commodities, went down to prices far below its intrinsic value. The expected European demand did not materialize; the interior buyer was overloaded with stock; and the losses of the coffee trade in 1920 will, it is to be hoped, never be repeated.

#### *The Story of Soluble Coffee*

Since the early 'nineties, many coffee men and chemists have been seeking a soluble coffee or dried extract that would simplify the preparation of the beverage. Although numerous companies have put such products on the market, only two of them have met with any commercial success. The success of these, however, has been considered enough to warrant telling here, though briefly, the story of soluble coffee.

Dr. Sartori Kato, a Japanese chemist of Tokyo, brought a soluble tea to Chicago about 1899. It was not a success, but it served to bring him in touch with some coffee men and chemists for whom he produced a soluble coffee in the same year. A company was organized to promote the product. It was called the Kato Coffee Company and included, in addition to Dr. Kato, Phillip Kreissel, a chemist; W. R. Ruffner, a green-coffee broker; and I. D. Richheimer, a coffee roaster. Kato's soluble coffee was first sold to the public at the Pan-American Exposition in 1901. The first quantity order was received from Captain Baldwin and was used by him with satisfaction on the Ziegler Arctic Expedition. United States patents on a coffee concentrate, and process for making the same (soluble coffee), were granted to Sartori Kato of Chicago, assignor to the Kato Coffee Co., of the same place, on August 11, 1903.

G. Washington, who was born in Belgium of English parents, and who was living temporarily in Guatemala City, invented about 1906, a soluble coffee that was made ready for the market in 1909.

It so happened one day that Mr. Washington, following his usual custom, was



dining in the open air beneath the shade of his orange trees. His coffee, in a silver pot, was set upon the table and while waiting for Mrs. Washington to join him, he noticed that a brown powder had formed below the spout of the coffee pot. He tasted it and found it had real coffee flavor. This set him thinking. Why wouldn't it be possible to prepare large amounts of coffee in this manner and ship it to all countries. It took Mr. Washington several years to perfect a process which would reproduce the rich-flavored, brown powder he had found on his coffee pot.

The G. Washington Coffee Refining Company was organized in 1910 to put the G. Washington product on the market, which it did first under the name "Red E Coffee." This was later changed to "G. Washington's Prepared Coffee," and was finally called "G. Washington's Instant Coffee." Associated with Mr. Washington at the start of the enterprise were E. Van Etten, former vice-president of the New York Central Railroad; W. J. Arkell; Bartlett Arkell, of the Beechnut Packing Company; C. M. Warner, of the Warner Sugar Refining Company, and Charles E. Proctor, of the Singer Sewing Machine Company.

The G. Washington Coffee Refining Company had its first coffee roasting and preparing plant in the Bush Terminal in Brooklyn, but in 1927 moved to its modern coffee refining plant in Morris Plains, New Jersey. The process is a secret one and has never been patented.

F. Lehnhoff Wyld, who was the Washington's family physician when they lived in Guatemala and with whom Mr. Washington had discussed his work in soluble coffee, attempted to duplicate the Washington product in 1913, and to put on the European market a soluble coffee under the name of "Belna." This undertaking, however, did not prove a successful commercial venture. A number of United States patents have been granted on soluble coffee that have never been applied commercially. Nowhere has soluble coffee met with such success as in the United States and Canada.

It was the World War that brought soluble coffee to the front. E. F. Holbrook, formerly in charge of the coffee section, subsistence division, United States War Department, called it "one of the most important articles of subsistence used by the army." Early in the war, soluble coffee was added to the reserve ration,

three-quarters of an ounce being considered at first the proper amount per ration. After trying to put it up in sticks, tablets, capsules, and other forms, it was determined that the best method was to pack it in envelopes. The whole output of the G. Washington Coffee Refining Company and other manufacturers was taken for army use. It was at this time that the Baker Importing Co., of Minneapolis, started the manufacture of "Barrington Hall" brand soluble coffee and they have remained in the market ever since.

Since the war, the G. Washington Coffee Refining Company has again established its distribution throughout the United States and Canada, and most foreign countries. Rival products have sprung up in many places, but most of them have been short-lived. The nearest to obtaining any degree of success was the soluble coffee put out by the Baker Importing Company. The C. F. Blanke Tea and Coffee Co., St. Louis, have always made a soluble coffee, changing the name frequently; the names varying from "Magic Cup," "Fairy Cup" to "Faust Brand," and later still, "Blanke's Health Coffee." Charles G. Hires Co., Philadelphia, put an instant coffee on the market, but it did not last long. The Soluble Coffee Co. of America put out the "Ev-Ry-Da Brand." Borden's Farm Products Co., New York, manufactured a coffee, combined with condensed milk and sugar. Alice Foote MacDougall Products Corp., New York, distributed the "Mansion Brand Instant Coffee." The Dearborn Coffee Co., Chicago, put out the "Dearborn Soluble Coffee." Fine Arts Coffee Co., Inc., New York, put out "Fine Arts Coffee," and the Allied Grocers, Inc., New York, put out "Kitchenet Coffee." None of them, however, were profitable ventures.

William A. Hamor and Charles W. Trigg, Pittsburgh, assignors to John E. King, Detroit, were granted a United States patent in 1919 on a process for making a new soluble coffee. Their process consists in bringing the volatilized caffeol in contact with a petrolatum, or absorbing medium, where it is held until needed for combination with the evaporated coffee extract. The King Coffee Products Corp. of Detroit was organized in 1920 to manufacture this product, known as "Minute Coffee," and a coffee base for soft drinks, the latter being marketed under the name of

"Coffee Pep." Both products were discontinued in 1928.

*Berent Friele, the World's Largest  
Coffee Buyer*

A name that stands out among present-day coffee men is that of Berent Friele, whose influence in the coffee industry is world-wide. As buyer for the Great Atlantic & Pacific Tea Co., New York, his annual coffee purchases total over 200,000,000 pounds, making him the largest buyer of coffee in the world. He buys approxi-



Mr. Berent Friele

mately 14 per cent of the annual imports of coffee into the United States. It is not, however, mere volume of coffee purchases that entitles Berent Friele to a place of prominence in the coffee business. He has a keen appreciation of the interdependence of all factors in the coffee industry and is usually identified with any movement designed to help the industry as a whole and to promote coffee consumption in general. He is largely responsible for the development of the Great Atlantic & Pacific Tea Company's present comprehensive buying organization in the producing countries. This has brought him in close contact with growers and government officials in those countries and through them he continually seeks to promote better understandings between producers and distributors and to assist the growers in the improvement of their product.

In the United States Mr. Friele has long been active in the promotion of cooperative effort to stimulate coffee consumption. He has taken a leading part in the furtherance of publicity efforts in the United States sponsored by Brazil, Colombia, and other producing countries. Any movement

that is calculated to help the coffee trade always finds in Mr. Friele an able supporter. His efforts to foster good-will between the United States and the producing countries extends well beyond the coffee business. In 1934 he was elected president of the American Brazilian Association of New York, which organization aims to develop and conserve a mutual knowledge and understanding between the two republics.

Mr. Friele's progress in coffee is the story of diligence, perseverance and innate ability coupled with a thorough schooling in the coffee business. He was born in Bergen, Norway, March 29, 1895, and is descended from a family of coffee merchants. Although his father died when Mr. Friele was quite young, he was given a college education in Norway and Germany under the guidance of his grandfather and uncle, in order that he might be prepared to continue the coffee business of B. Friele & Sons, Bergen, founded in 1800, which has been in the family for five generations, and of which his father had been a partner.

Mr. Friele started his business career in 1916 as a coffee buyer for the Bergen firm in Brazil after preliminary study of the coffee business in Germany, France, and England. He was in Brazil for a number of years, engaged in the selection and purchase of coffee, and there he was attracted by the great possibilities for enlarging the market for coffee in the United States.

His unusual qualifications as an organizer and buyer had, meanwhile, come under the observation of important American coffee interests and, in 1919, he was asked to take charge of the American Coffee Corporation, the newly-formed subsidiary of the Great Atlantic and Pacific Tea Company, organized for the purpose of establishing buying offices to select and buy coffee in the producing countries.

It is believed that the foreign organization developed under Mr. Friele's direction has been the greatest factor in the remarkable growth of the Great Atlantic & Pacific Tea Company's coffee business.

PACKAGE DESIGN AND LABELLING PROMOTE COFFEE SALES



SOME COFFEE BRANDS ADVERTISED IN THE UNITED STATES

These are but a few out of the hundreds of package coffees that are advertised and distributed in the United States. This group exemplifies the number of types and the variety and attractiveness of their label designs.

## CHAPTER XXXII

### A SHORT HISTORY OF COFFEE ADVERTISING

EARLY COFFEE ADVERTISING—THE FIRST PRINTED ADVERTISEMENT IN ENGLISH—THE FIRST NEWSPAPER ADVERTISEMENT—EARLY ADVERTISEMENTS IN COLONIAL AMERICA—EVOLUTION OF ADVERTISING—PACKAGE COFFEE ADVERTISING—ADVERTISING TO THE TRADE—ADVERTISING BY MEANS OF NEWSPAPERS, MAGAZINES, BILL-BOARDS, ELECTRIC SIGNS, MOTION PICTURES, RADIO, DEMONSTRATIONS, AND SAMPLES—ADVERTISING BY RETAILERS—GOVERNMENT PROPAGANDA—COFFEE ADVERTISING EFFICIENCY—PROGRESS OF COFFEE ADVERTISING

**I**N A work of this character the chapter on advertising must of necessity be in story form. It may tell what has been accomplished in advertising coffee, and perhaps point the way to greater achievement. In so far as possible, the story is supplemented by illustrations, which tell the story even better than words.

Advertising to the trade or the consumer calls for expert advice. There are successful trade journalists who are competent to supply such advertising counsel; and newcomers in the field should consult them first. These men are in the best position to suggest the means for successful accomplishment. They know the men who are best qualified to render assistance for all media, and are glad to recommend those who can be most helpful.

Jarvis A. Wood has said that advertising is causing another to know, to remember, and to do. If we agree with this excellent definition, then the first coffee advertisers were the early physicians and writers who told their fellows something about the berry and the beverage made from it.

Rhazes and Avicenna told the story in Latin, and appear to have recommended a coffee decoction as a stomachic, as far back as the tenth century. Many other early physicians refer to it. Thus it was that coffee was solemnly introduced to the consumer as a medicine. The first step made by the berry from the cabinets of the curious, where it was known as an exotic seed, was into the apothecaries' shops, where it

was sold and advertised as a drug. Next, the coffee drink was advertised and sold by lemonade venders; then by the proprietors of the coffee houses and cafés; and finally the coffee merchant sold and advertised the green and roasted bean.

Rauwolf told the Germans about it in 1582; Abd-al-Kadir wrote his famous *Argument in favor of the legitimate use of coffee* in Arabic about 1587; Alpini carried the news to Italy in 1592; English travelers wrote about the beverage in the sixteenth and seventeenth centuries; French Orientalists described it about the same time; and America learned about it long before the green beans were offered for sale in Boston in 1670.

Because of its frank propaganda character, Abd-al-Kadir's manuscript may rightly be called the earliest advertisement for coffee. The author was a lawyer-theologian, a follower of Mahomet, and as such was eager to convince his contemporaries that coffee drinking was not incompatible with the prophet's law.

Soon the news of the day became the advertising of the morrow. In 1652, the first printed advertisement of coffee in English appeared. It was in the form of a shop-bill, or handbill, issued by Pasqua Rosée from the first London coffee house in St. Michael's Alley, Cornhill. The original is preserved in the British Museum.

It is pictured on page 50, chapter IX, and is worthy of close examination. It reads:

The Vertue of the *COFFEE* Drink

First publicly made and sold in England by *Pasque Rosee*.

The Grain or Berry called *Coffee*, groweth upon little Trees, only in the *Deserts of Arabia*.

It is brought from thence, and drunk generally throughout all the Grand Seigniors Dominions.

It is a simple innocent thing, composed into a Drink, by being dried in an Oven, and ground to Powder, and boiled up with Spring water, and about half a pint of it to be drunk, fasting an hour before, and not Eating an hour after, and to be taken as hot as possibly can be endured; the which will never fetch the skin off the mouth, or raise any Blisters, by reason of that Heat.

The Turks drink at meals and other times, is usually *Water*, and their Dyet consists much of *Fruit*, the *Crudities* whereof are very much corrected by this Drink.

The quality of this Drink is cold and Dry; and though it be a Dryer, yet it neither *heats*, nor *inflames* more then *hot Posset*.

It so closeth the Orifice of the Stomack, and fortifies the heat within, that it's very good to help digestion, and therefore of great use to be taken about 3 or 4 a Clock afternoon, as well as in the morning.

It much quickens the *Spirits*, and makes the Heart *Lightsome*. It is good against sore Eys, and the better if you hold your Head over it, and take in the Steem that way.

It suppresseth Fumes exceedingly, and therefore good against the *Head-ach*, and will very much stop any *Defluacion of Rheums*, that distil from the *Head* upon the *Stomach*, and so prevent and help *Consumptions*; and the *Cough of the Lungs*.

It is excellent to prevent and cure the *Dropsy*, *Gout*, and *Scurvy*.

It is known by experience to be better than any other Drying Drink for *People in years*, or *Children* that have any *running humors* upon them, as the *Kings Evil*, &c.

It is very good to prevent *Mis-carryings* in *Child-bearing Women*.

It is a most excellent Remedy against the *Spleen*, *Hypocondriack Winds*, or the like.

It will prevent *Drowsiness*, and make one fit for business, if one have occasion to *Watch*; and therefore you are not to Drink of it *after Supper*, unless you intend to be watchful, for it will hinder sleep for 3 or 4 hours.

*It is observed that in Turkey, where this is generally drunk, that they are not troubled with the Stone, Gout, Dropsie, or Scurvey, and that their Skins are exceedingly cleer and white.*

It is neither *Laxative* nor *Restrington*.

Made and sold in *St. Michaels Alley* in *Cornhill*, by *Pasque Rosée*, at the Signe of his own Head.

The noteworthy thing about this advertisement is, that even in comparison with the best copy of today, it has high merit. For this early advertisement seems to have embodied in it superbly well those qualifications which modern advertising experts agree are essential requirements for suc-

cess—measured in terms of sales to the consumer. We shall return to it later.

The first newspaper advertisement for coffee appeared in the form of a "reader" in the issue of *The Publick Adviser*, London, for the week of Tuesday, May 19, to Tuesday, May 26, 1657. *The Publick Adviser* was a weekly commercial news-letter. The advertisement was sandwiched between a reader, advertising a doctor of physick, and one for an "artificer," the latter being a ladies' hair-dresser. It was as follows:

In *Bartholomew Lane* on the back side of the Old Exchange, the drink called *Coffee*, (which is a very wholesom and Physical drink, having many excellent vertues, closes the Orifice of the Stomack, fortifies the heat within, helpeth Digestion, quickneth the Spirits, maketh the heart lightsom, is good against Eye-sores, Coughs, or Colds, Rhumes, Consumptions, Head-ach, Dropsie, Gout, Scurvy, Kings Evil, and many others is to be sold both in the morning, and at three of the clock in the afternoon.

About the time that Pascal opened the first coffee house in Paris in 1672, the Paris shopkeepers began to advertise coffee by broadsides. A good example is the following, the text of which closely resembles the original by *Pasqua Rosée*:

*The most excellent Virtue of the Berry called Coffee.*

*Coffee* is a Berry which only grows in the desert of *Arabia*, from whence it is transported into all the Dominions of the Grand Seigniour, which being drunk dries up all the cold and moist humours, disperses the wind, fortifies the Liver, eases the dropsie by its purifying quality, 'tis a Sovereign medicine against the itch, and corruptions of the blood, refreshes the heart, and the vital beating thereof, it relieves those that have pains in their Stomach, and cannot eat; It is good also against the indispositions of the brain, cold, moist, and heavy, the steam which rises out of it is good against the *Rheums* of the eyes, and drumming in the ears: 'Tis excellent also against the shortness of the breath, against *Rheums* which trouble the Liver, and the pains of the Spleen; It is an extraordinary ease against the Worms: After having eat or drunk too much: Nothing is better for those that eat much Fruit.

The daily use hereof in a little while will manifest the aforesaid effect to those, that being indisposed shall use it from time to time.<sup>1</sup>

The following are typical London trade advertisements of 1662 and 1663. The first is from the *Kingdom's Intelligencer* of June 5, 1662, and reads as follows:

<sup>1</sup> Chamberlaine, John, translation, London, 1685, from *Dufour's Traitez Nouveaux et Curieux du Café, du Thé, et du Chocolat*.



At the Exchange Alley from Cornhill into Lumber Street near the Conduit, at the Musick-Room belonging to the Palsgrave's Hall, is sold by retayle the right coffee powder; likewise that termed the Turkey Berry, well cleansed at 30d. per pound. the East India berry (so called) of the best sorts at 20d. per pound, of which at present in divers places there is very bad, which the ignorant for cheapness do buy, and is the chief cause of the now bad coffee drunk in many plaies (sic.).

The *Intelligencer* for December 21, 1663, contained the following advertisement:

There is a Parcel of Coffee-Berry to be put to publique sale upon Wednesday, the 23. instant, at 6 a clock in the evening at the Globe Coffee house at the end of St. Bartholomew Lane, over against the North Gate of the Royall Exchange. . . And if any desire to be further informed they may repair to Mr. Brigg, Publique Notary at the said Globe Coffee-house.

Dufour's treatise on *The Manner of Making Coffee, Tea, and Chocolate*, published in Lyons, 1671, was generally regarded as propaganda for the beverage; and, indeed, it proved an excellent advertisement, being translated into English in 1685.

In 1691 we find advertised in the *Livre Commode* of Paris a portable coffee-making outfit to fit the pocket.

The first coffee periodical, *The New and Curious Coffee House*, was issued at Leipzig by Theophile Georgi in 1707, being a kind of house organ for what was, perhaps, the first kaffee-klatsch; the publisher-proprietor, however, admitted that the idea of making his coffee salon a resort for the literati was obtained from Italy.

In chapter IX we have described a number of broadsides, handbills, and pamphlets having to do with the introduction of the coffee drink into London between 1652 and 1675. The advertising student would do well to refer to them because they serve to show how completely the true merits of the beverage were lost sight of by those who urged its more fantastic claims. It is interesting to note, however, that this early copy was of a high order of typographical excellence; indeed, the display letter used for the word coffee is often like that found in copy in the United States two hundred and seventy years after. Also, it should be noted that "apt 'illustrations's' artful aid" was first employed in 1674. Again, note this curious contrast. Two hundred and eighty-three years ago all the resources of advertising were being laid under contribution to make propaganda for coffee as the great cure for many ail-

### New Coffee Manufactory.

Highly necessary in this City,

THE subscriber informs the public that he has provided himself with proper utensils at a considerable expence, to burn, grind and clarify Coffee on the European plan, so as to give general satisfaction; this useful Manufactory would save the inhabitants, on reflection, considerable, in that article, as it is often thro' want of knowledge or wrong management injured and spoiled by trusting to careless servants; whereas one making it his business to serve the citizens with coffee ready prepared would be able to make it better and sell it cheaper than it could be bought in the grain, besides loss of time, waste and expence. This undertaking invites the public to try the experiment, as it may be had in pots of various sizes, from one to twenty weight, well pack'd down either for sea or family use, so as to keep good for twelve months, and be clear, strong and well tasted, from a proper receipt. Apply at No. 4, Great Dock Street. Feb. 9.

FIRST NEWSPAPER ADVERTISEMENT SOLELY FOR  
COFFEE IN THE UNITED STATES

*New York Daily Advertiser*, February 9, 1790

ments of which nowadays the enemies of coffee would have us believe coffee is the cause! Those who have possessed themselves of the facts about coffee know that both arguments are equally fantastic.

Coffee was mentioned in shop-keepers' announcements appearing in the *Boston News Letter* as early as 1714, and in other newspapers of the American colonies during the eighteenth century, usually being offered for sale at retail with strange companions. In 1748, "tea, coffee, indigo, nutmegs, sugar, etc.," were advertised for sale at a shop in Dock Square, Boston. The following advertisement from the *Columbian Centinel*, Boston, April 26, 1794, is typical:

GROCERIES AT NO. 44 CORNHILL

Norton and Holyoke

Respectfully inform their friends and the publick, that they have for sale, at their Shop, No. 44 Cornhill, formerly the Post-Office,

A GENERAL ASSORTMENT  
OF GROCERIES

among which are the following articles: Teas, Spices, Coffee, Cotton, Indigo, Starch, Chocolate, Raisins, Figs, Almonds, and Olives; West India Rum, best French Brandy, excellent Cherry Wine, pure as imported, etc., etc., all which they will sell as low as any store in Boston.

Any article not liked will be taken again, and the money returned.

**FRANKLIN**  
**TEA & COFFEE WAREHOUSE,**  
No. 29 FRANKLIN AVENUE, near 4th St.,  
**SAINT LOUIS.**  
**ESTABLISHED 1853.**

THE FRANKLIN TEA AND COFFEE WAREHOUSE was opened for the supply of Families with those prime necessities, Tea and Coffee, and each month has witnessed a great accession to the number of purchasers. The increasing amount of patronage with which I have been favored, is a satisfactory testimonial to the soundness of the principles upon which the undertaking was founded. Those principles were scrupulous care in selecting those qualities of Tea and Coffee most suitable to family use, an economical system of management, and such moderate charges as can only be guaranteed by a rigid adherence to the system of Cash payments. It may be necessary to remind my friends and the public, that in the Tea department of my business, a very critical judgment, the result of practical experience, is indispensably necessary in order to ascertain the different qualities.

The same principle is rigidly adhered to in the Coffee department. An equal amount of tact and skill is required in order to secure for the customer a full, rich, mellow, fine flavored Berry, from which alone a good cup of this delicious beverage can be extracted. It is a matter of importance that the Roasting process should be so conducted as to prevent the escape of that volatile oil with which the Berry is impregnated, and to which it principally owes its tone and other medicinal qualities. My arrangements by Steam-power for roasting and grinding Coffee, cannot be surpassed by any establishment west of New York, and my knowledge practical, I therefore pledge myself no please in all cases, or the packages may be returned.

I am now receiving a large assortment of all the different grades of GREEN AND BLACK TEAS, selected with care from the principal dealers in New York, which I am enabled to sell for Cash at such prices as must give satisfaction to every one who will favor me with a trial.

**JAMES FORBES.**

NO. 29 FRANKLIN AV.,  
NEAR FOURTH STREET, A FEW DOORS WEST OF BROADWAY, WITH STEAM  
ENGINE AND COFFEE MILLS IN THE WINDOW.

Fresh Parched and Ground Coffee always on hand—Warranted.

#### A ST. LOUIS HANDBILL OF 1854

It appears that the first advertisement dealing with coffee alone was published in the *New York Daily Advertiser* for February 9, 1790; and this was primarily an advertisement of a wholesale coffee roasting factory rather than an advertisement of coffee per se. This advertisement is reproduced on page 471.

Not until package coffee began to come into vogue in the sixties was there any change in the stereotyped business-card form followed by all dealers in coffee. And even then the monotony was varied only by inserting the brand name, such as "Osborn's Celebrated Prepared Java Coffee. Put up only by Lewis A. Osborn"; "Government coffee in tin foil pound papers put out by Taber & Place's Rubia Mills."

#### Evolution of Coffee Advertising

Real progress in coffee advertising, as in publicity for other lines of trade and industry, began in the United States. Here too, it has been brought to its lowest degradation and to its highest efficiency. The entire process has taken something less than seventy-five years.

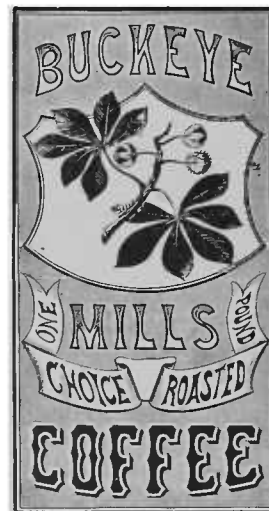
The first step forward was the picture handbill. The handbill, or dodger, had

been common enough in England and on the Continent, where, for upward of two hundred years it had served as an advertising medium, in company with the more robust broadside, and in competition with the pamphlet and newspaper. It remained for America, however, to glorify the handbill by means of colored pictures; and one of the earliest and best specimens of the picture handbill is the Arbuckle circular here illustrated.

Soon the handbill copy began to appear in the newspapers, but mostly without the illustrations. Later newspaper developments were to introduce more of the picture element, decorative border, and design. The ideas of European artists were borrowed freely, but were put to such utilitarian uses that their originators would scarcely have recognized them.

In the *Ladies Home Journal* for December, 1888, the Great London Tea Company, Boston, an early mail-order house, advertised, "We have made a specialty since 1877 of giving premiums to those who buy tea and coffee in large quantities." In the same issue, there was an advertisement of Seal Brand and Crusade Brand coffee by Chase & Sanborn, Boston. Dilworth Bros., Pittsburgh, were also among the early users of magazine space.

The menace of the cereal coffee-substitute evil had grown to such proportions at the beginning of the twentieth century, that the coffee men began to be concerned about it. Misleading and untruthful "substitute" copy was freely accepted by nearly all media. The package labels were as misleading, if not more so. With the advent of the pure food law of 1906, the cereal label was reformed; but not until the "truth in advertising" movement became a power to be reckoned with, nearly ten years later, were the coffee men granted a substantial measure of protection in the magazines and newspapers. Meanwhile, many coffee men, lacking or-



First Registered Trade  
Mark for Coffee, 1871



IT IS CHEAPER TO BUY  
**ARBUCKLES'**  
**ROASTED COFFEE**  
In One Pound Air-Tight Packages,  
Than to Buy Green Coffee and Roast it yourself.

**WHY?**

Because four pounds of ARBUCKLES' ROASTED COFFEE will go as far as five pounds of green Coffee, as Coffee loses one fifth in roasting by hand. Arbuckles' Roasted Coffee is much better, as every grain is evenly roasted, thus bringing out the full strength and aroma of the Coffee. You cannot roast Coffee properly yourself.

FIRST HANDBILL IN COLORS FOR PACKAGE COFFEE,  
ABOUT 1872

ganization and a knowledge of the facts about coffee, unwittingly played into the hands of the substitute-fakers by publishing unfortunate defensive copy which made confusion worse confounded in the consumer's mind.

At one time there were nearly one hundred coffee-substitute concerns engaged in a bitter, untruthful campaign directed against coffee. The most conspicuous offender employed the principle of auto-suggestion and found a goodly number of pseudo-physicians and bright advertising minds that were quite willing to prostitute their finest talents to aid him in attacking an honorable business.

In one year \$1,765,000 was spent in traducing the national beverage. The burden of the cereal-faker's song was that coffee was the cause of all the ills that flesh is heir to, and that by stopping its use for ten days and substituting his panacea, these ills would vanish.

Of course, there were many people—but they were the minority—who knew that the caffeine content of coffee was a pure, safe

stimulant that did not destroy the nerve cells like such false stimulants as alcohol, morphine, etc.; and that while too much could be ingested from abuse of any beverage containing it, nature always effected a cure when the abuse was stopped.

However, there was undoubtedly created in the minds of otherwise sane and normal people a suspicion that perhaps coffee was not good for them.

Then came the winter of the coffee men's discontent. Floundering about in a veritable slough of cereal slush, without secure foothold or a true sense of direction, coffee advertising went miserably astray when its writers began to assure the public that *their* brands were guiltless of the crimes charged in the cereal men's indictment. In this, of course, they unwittingly aided and abetted the cereal fakers. For example, one roaster-packer advertised, "The harmful ingredient in coffee is the tannin-bearing chaff, which our roasting and grinding process completely removes." Scientific research has since proved the fallacy of this idea.

Another roaster said, "if coffee works havoc with your nerves and digestion, it is because you are not using a fresh roasted, thoroughly cleaned, correctly cured coffee. Our method of preparing gives you the strength and aroma without its nerve-destroying qualities." A well known coffee packer advertised, "Our coffee is free from the dust and bitter tannin—the only injurious property in coffee." Still another packer informed the consumer that "by a very special steel cutting process" he sliced the coffee beans "so that the little cells containing the volatile oil (the food product) are not broken."

A prominent Chicago packer put out a new brand of coffee which he claimed was "non-intoxicating," "poisonless," and the "only pure coffee." A New Yorker, not to be out-done, brought out a coffee that he said contained all the stimulative properties of the original coffee berries, but with every trace of acid removed, every undesirable element eliminated. "Also," he added for good measure, "this coffee may be used freely without harming the digestive organs or impairing the nervous system."

And one package-coffee man became so exercised over cereal competition that he brought out a *grain* "coffee" of his own, which he actually advertised as "the near-

## The Case For Coffee

### Number Six

What experienced physician can or will deny the power and influence of suggestion—auto or extra—upon the mind and body of his patients—or himself? Such suggestion influences the action and effect of foods as well as drugs—one patient cannot eat this; another can. Certain patients, provided suggestion is sufficiently potent, ascribe benefit to medicine taken that is purely placebo. Herein may be found the explanation of the harmful effects ascribed to coffee, by the exceedingly small number of people who claim to be injuriously affected by it—as well as the efforts of those who are selfishly interested in the exploitation of coffee substitutes. Those who are susceptible to the power of suggestion, respond quickly to oft-repeated fallacy or distorted statement. Eas-

ily convinced themselves, they succeed in influencing others. The result of this is a collection of so-called clinical evidence that is apt to influence the careless physician who does not analyze carefully, who overlooks the importance of *post non propter hoc* in the Science and Art of Medicine. "He gets not far in medicine who takes anything for granted." Hence, the conscientious and the wise doctor should not accept without analysis, nor condemn without reason.

He should differentiate between fallacy and fact, in order that he may most efficiently practice the art which above all other arts, demands accurate and exact estimation of the relation between cause and effect. Eschew suggestions—hold fast to facts. See next issue.

Copyright 1920 by the Joint Coffee Trade  
Publicity Committee of the United States

## The Case For Coffee

### Number Seven

We owe to Pavlov, and other eminent seekers after physiological truth, the knowledge of the value of mental stimulation in producing the so-called "appetite juice" without which gastric digestion cannot be efficiently performed. Hence we can understand why and how, to most individuals, the thought, anticipation and odor of the morning cup of coffee is of practical value in bringing about the proper enjoyment and digestion of what is or should be the most important of the daily meals.

"Without coffee," wrote a wise doctor, "breakfast is a meal instead of an institution." The craving for the matutinal cup of coffee is not a cry of the body for a stimulating drug, not the prompting of a bad habit. It is a physiological demand for aid in the performance of normal digestion.

Nature is wise in her provision of coffee to begin the first meal of the day, to awaken and activate digestive processes made dormant during the period of the body's lowest vitality. Also of coffee after dinner to assist in the digestion of the heaviest meal when functions are depressed as a result of the day's struggle. If coffee be a habit—so is appetite. One is almost as helpful and as necessary to the average individual as is the other.

Realizing these facts, physicians will be slow to condemn or to forbid the use of coffee—in moderation—because of certain fallacies or half-truths, promulgated by those who neither analyze nor weigh the evidence, or who are influenced by prejudice, selfish interest or exploitation of substitutes for "Nature's most prized beverage." More anon.

Copyright 1920 by the Joint Coffee Trade  
Publicity Committee of the United States

## The Case For Coffee

### Number Eight

"Science," wrote a great scientist, "has neither reason nor excuse for jumping at conclusions."

Yet, "jumping at conclusions"—or the assumption of fact from insufficiently analyzed evidence—has more than anything else retarded the progress of practical medicine.

Assumption, for example, that uric acid is the cause of rheumatism, gout and many other functional or organic disturbance or disorder of body organs or tissues, prevented for years the recognition of the true cause of such conditions and the real nature of uric acid, indican, etc.

Attempts therefore to condemn coffee as a source of uric acid or metabolic waste products, while given credence in the past, lose all force in the light of present knowledge. Old-

fangled dietaries used to proscribe coffee—modern ones allow it or prescribe it. We formerly forbade sugar and carbohydrates in diabetes mellitus. Today, knowing the patient can tolerate these in moderation, we allow them to be so taken. There was a time, when all water or liquid was forbidden during fevers. We used to bleed or purge *secundum artem* for so-called "reasons" arrived at by "jumping at conclusions." As for coffee, accused upon hearsay and prejudice of being a "dangerous drug" capable of doing considerable harm, we now realize and recognize it as possessing definitely beneficial therapeutic properties. Let no physician condemn or forbid coffee unjustly or as a result of "jumping at conclusions."

See next issue.

Copyright 1920 by the Joint Coffee Trade  
Publicity Committee of the United States

## The Case For Coffee

### Number Nine

Hippocrates recognized the influence of temperament in the production of symptoms. It is often said that "as a nation we live and work and play upon our nerves." To "nervousness" is ascribed much of the functional disturbance that provides physicians with many patients. Why deny the fact? But on the other hand, why attempt to saddle upon certain articles of food or drink the onus of inducing "nervousness?"

Take coffee for example, accused of producing nervousness by over-stimulation of cardiac or cerebral functions. Nervousness is a mental phenomenon mostly. Excessive fatigue, overuse of muscles or mind, overwork of digestive organs, increased mental strain, worry, insistence upon brain effort in spite of Nature's effort to rest and to recuperate, impaired nutrition favored by impure or

anemic blood, laden with toxins absorbed as a result of intestinal stasis, deficient oxidation or exercise, excessive use of vital forces, all these are upon analysis the causes of "nervousness." Yet how often patient and physician make or attempt to make coffee a scapegoat for symptoms complained of!

Analysis of symptoms, of secretions, and excretions, of habits, will, almost without exception, point away from coffee and toward some more rational and direct exciting cause. Withdrawal of coffee does not often remedy the condition. Removal of the real causes, usually permits of resumption of the use of coffee. Forbid coffee if you can convince your reason that it is in part responsible. But do not make it a scapegoat to excuse or avoid getting at the real cause. See next issue.

Copyright 1920 by the Joint Coffee Trade  
Publicity Committee of the United States

TELLING THE DOCTORS THE TRUTH ABOUT COFFEE, 1920

est approach to coffee ever put on the market, having all the merits without any objectionable features, strengthening without stimulating, satisfying without shattering the nerves."

And so history again repeated itself in America. Five hundred years after the first religious persecution of the drink in Arabia, we find it being persecuted by commercial zealots in the United States. And even in the house of its friends, coffee was being stabbed in the back. The coffee merchants themselves presented the spectacle of "knocking" it by inference and innuendo.

Something had to be done. As cereal drinks, standing on their own feet, the coffee "substitutes" would have attracted little notice. It was only by trading on the allegation that they were *substitutes for coffee* that they made any headway. The original offender sold his product as "coffee," which was an untruth, as he later admitted there was not a bean of coffee in it. He boldly advertised: "Blank coffee for persons who can't digest ordinary coffee."

When it became no longer possible to perpetrate an untruth on the package label, there still remained the newspapers and

billboards. For years before fake-advertising laws and an outraged public opinion made recourse to these no longer possible, it was a common practice to use the newspapers and billboards to promote the idea that here was a different coffee; and in this way to create a demand for a package, which, when purchased, was found to tell a different story.

As late as 1911, one of our most respected New York dailies was carrying an advertisement calling the product "coffee," although fairness demands it be recorded that the coffee part of the announcement was stricken out when *The Tea and Coffee Trade Journal* called the attention of the publisher to its misleading character. This trade paper, from its start, had been urging the coffee men to organize for defense. The agitation bore fruit at last, first in the starting of the National Coffee Roasters Association, and later in the inception of the movement that resulted in a cooperative advertising campaign for coffee under the auspices of the coffee growers of Brazil and the National Coffee Roasters Association.

Meanwhile, the cereal coffee-substitute had been thoroughly discredited by governmental analysis, although even today news-

### How to make GOOD COFFEE



**THE** greatest of coffee experts say to get a hot cup of coffee, use the best coffee available. Buy the best. Read the label. See the roaster's name. They may not be the same, but they are better coffee than you are now enjoying.

**Keep Your Coffee Air-tight**

- 1 Roasted coffee loses its flavor rapidly, especially if it is ground. All coffee and especially ground coffee, should be kept in a container that is airtight and in a dark, cool place, if possible.
- 2 Measure Carefully The amount of coffee to use depends upon the strength you like. If you want a weak cup, use less coffee. If you want a strong cup, use more. Measure proportions carefully, both coffee and water.
- 3 Use Grounds Only Once Do not reuse the coffee grounds in the pot and re-brew for the next meal. Used coffee grounds are full of oil and other substances which are bad for you. They also make good coffee taste when in boiling water.
- 4 Use Boiling Water The water used in making coffee should come to a full boil before it is poured from the pot over the coffee grounds. Do not get the water and the grounds heated together otherwise all mixed, but your coffee, too, will not be good.
- 5 Serve at Once Mix up a pot of perfect coffee has been ruined by waiting around. If you must wait, keep the coffee hot, but do not let it boil. Re-boiling injures the flavor.
- 6 Scour the Coffee Pot If it has enough to give the pot a heated clean and set it away in dry. Scour it even more carefully than after cooking vessels.

If you use a percolator, pay particular attention to the little side stream which has water over the coffee. It is the cause of the "stale" taste. Wash the side stream thoroughly with hot water for the pot.

If you use a filter pot with a filter bag, wash the bag and the pot thoroughly with hot water. Keep the bag clean by washing it in hot water when not in use. Remove filter bags frequently.

This advertisement is part of an educational campaign for the better coffee. It is published in cooperation with the National Coffee Roasters Association, Inc., 11 Wall Street, New York City.

Week Ending April 1st



### Serve COFFEE when you entertain

At the afternoon card party or in the evening when good friends call, there is nothing quite so sure to please—as coffee. It is a beverage that every one likes.

For there is warmth and good cheer as well as good fellowship in a cup of coffee.

Moreover, it may be served with equal propriety with the lowliest sandwich or the daintiest sweets. And it is always in good taste!

The phrase, "I certainly did have a good time," has a familiar ring to the hostess who serves—

**COFFEE - the universal drink**

This advertisement is part of an educational campaign for the better coffee. It is published in cooperation with the National Coffee Roasters Association, Inc., 11 Wall Street, New York City.

Week Ending April 8th

### Any Time is COFFEE-time



MEAL time, work time, play time—any time of coffee is its independence! It's breakfast, it's a good dinner. A simple sandwich and a piece of pie become a satisfying luncheon when you add a steaming cup of coffee.

Between meals—in mid-afternoon, perhaps, when mind and body begin to lag, it is the all the coffee hour in which it comes in the way from the middle of the afternoon when you are tired at home—in the day's hours after a stirring round of golf or an exhausting tennis match.

Whenever the occasion, the hour or the place—Coffee! No other beverage pleases so every one of people all the time.



**COFFEE - the universal drink**

This advertisement is part of an educational campaign for the better coffee. It is published in cooperation with the National Coffee Roasters Association, Inc., 11 Wall Street, New York City.

Week Ending March 11th

### COFFEE - the universal drink



"I drink it every afternoon"

"Started about five weeks ago. Friend of mine suggested it. Greatest thing in the world for business men, he said. 'Coffee you over the same hour of mid-afternoon'."

"Thought I'd humor him. Ordered a cup of coffee that afternoon at the soda fountain. Great stuff. I do more work now from three to five than I used to do all afternoon."

"Recommended it to my wife. She thinks it's great, too. Particularly on cold days. Always serves it when company comes. Better try it!"

"Believe me, it's a good suggestion to get down on your knees and under the head of Agrad—what new word which means 'strong' is 'coffee'."

After all, why not a mid-afternoon cup of coffee? Coffee helps you to start the day right. Why not appear on it strong about three or four o'clock?

This advertisement is part of an educational campaign for the better coffee. It is published in cooperation with the National Coffee Roasters Association, Inc., 11 Wall Street, New York City.

**COFFEE - the universal drink**

Week Ending March 25th





## On bended knees the black slaves served COFFEE


The story of coffee was not told in the past of America. It was told in the past of the world. It was told in the past of the East. It was told in the past of the West. It was told in the past of the South. It was told in the past of the North. It was told in the past of the East. It was told in the past of the West. It was told in the past of the South. It was told in the past of the North.

## He saved the last COFFEE plant-




The story of 200 years ago, he saved the coffee plant. It was the story of a man who saved the coffee plant. It was the story of a man who saved the coffee plant. It was the story of a man who saved the coffee plant. It was the story of a man who saved the coffee plant.

## The glory of Cornhill's Alley— COFFEE




In 1652, Cornhill's Alley was the glory of the city. It was the glory of the city. It was the glory of the city. It was the glory of the city. It was the glory of the city. It was the glory of the city. It was the glory of the city. It was the glory of the city.

## "The sovereign drink of pleasure and of health" COFFEE



Coffee has become the most popular beverage in the world. It is the sovereign drink of pleasure and of health. It is the sovereign drink of pleasure and of health. It is the sovereign drink of pleasure and of health. It is the sovereign drink of pleasure and of health.

## The drink of intellectuals COFFEE




Universal drink. The drink of intellectuals. It is the drink of intellectuals. It is the drink of intellectuals. It is the drink of intellectuals. It is the drink of intellectuals. It is the drink of intellectuals. It is the drink of intellectuals.

## The COFFEE House is coming back




The Coffee House is coming back. It is the coming back of the Coffee House. It is the coming back of the Coffee House. It is the coming back of the Coffee House. It is the coming back of the Coffee House. It is the coming back of the Coffee House.

## Café-Cawfee COFFEE




Café-Cawfee. The fighting man's drink. It is the fighting man's drink. It is the fighting man's drink. It is the fighting man's drink. It is the fighting man's drink. It is the fighting man's drink. It is the fighting man's drink.

## Eight bells in the mid-watch— COFFEE for the wheel & lookouts



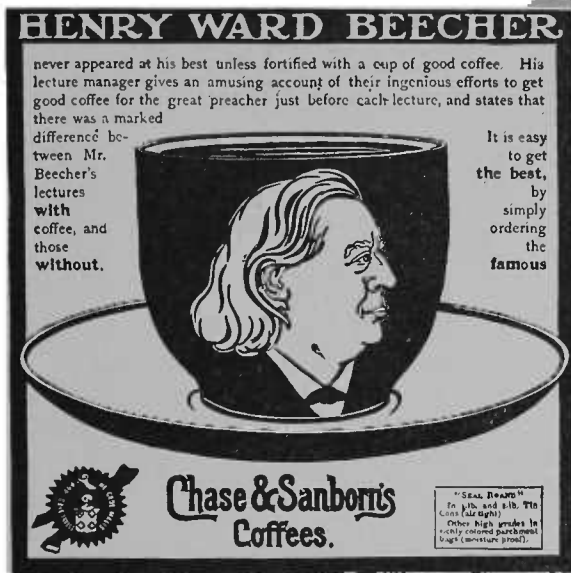
Eight bells in the mid-watch. Coffee for the wheel and lookouts. It is the coffee for the wheel and lookouts. It is the coffee for the wheel and lookouts. It is the coffee for the wheel and lookouts. It is the coffee for the wheel and lookouts.

## Your Uncle Sam provided his boys with COFFEE



Your Uncle Sam provided his boys with coffee. It is the coffee provided by Uncle Sam. It is the coffee provided by Uncle Sam. It is the coffee provided by Uncle Sam. It is the coffee provided by Uncle Sam. It is the coffee provided by Uncle Sam.

JOINT COFFEE PUBLICITY COMMITTEE MAGAZINE AND NEWSPAPER COPY, 1919



CHASE & SANBORN COPY, ABOUT 1900

paper publishers are to be found here and there who are willing to "take a chance" with public opinion and who will admit to their advertising columns such misleading statements for the substitute, as "it has a coffee-like flavor."

In the United States today, coffee advertising has reached a high plane of copy excellence. Our coffee advertisers lead all nations. The educational work started by *The Tea and Coffee Trade Journal*, fostered by the National Coffee Roasters Association, and developed by the Joint Coffee Trade Publicity Committee, the Brazilian-American Coffee Promotion Committee, and the Associated Coffee Industries of America, has laid low, many of the bugaboos raised by the cereal sinners. The coffee men, however, have left considerable room for improvement. There are still some who are given to making exaggerated claims in their publicity, who make reflections upon competitors in a way to destroy public confidence in coffee, and who display an ignorance of, or a lack of confidence in, their product by continuing to claim that their brands do not contain what they assert are injurious or worthless constituents. It is to be hoped that in time these abuses will yield to the further enlightening influence of the trade press, and of the organizations that are continually working for trade betterment.

Before the international coffee campaign started in 1919, the National Coffee Roasters Association promoted two national coffee

weeks, one in 1914 and another in 1915, wherein an excellent foundation was laid for the big joint coffee-trade propaganda that followed. Some original research also was done along lines of proper grinding and correct coffee brewing. A Better-Coffee-Making Committee, under the direction of Edward Aborn of New York, rendered yeoman's service to the cause. Much educational work was done in schools and colleges, among newspaper editors, and in the trade. This campaign was the first cooperative publicity for coffee. Among other things, it put a nation-wide emphasis on iced coffee as a delectable summer drink and, for the first time, stressed the correct making of the beverage by drip and filtration methods instead of by boiling, which had long been one of the most crying evils of the business.

*Package Coffee Advertising*

Coffee advertising began to take on a distinctive character with the introduction of "Ariosa" by John Arbuckle in 1873. Some of the early publicity for this pioneer package coffee appears typographically crude, judged by modern standards, but the copy itself has all the needful punch,



SPECIMEN OF EARLY YUBAN COPY



HOW TWO WELL-KNOWN COFFEE BRANDS HAVE BEEN ADVERTISED OUTDOORS

and many of the arguments are just as applicable today as they were a half-century ago. Take the handbill on page 473. It was done in three colors, and the argument was new and most convincing. The reverse side copy was also extremely effective.

Most of the original Arbuckle advertising was by means of circulars or broadsides, although some newspaper space was employed. Premiums were first used by John Arbuckle as an advertising sales adjunct, and they proved a big factor in putting "Ariosa" on the map. Mr. Arbuckle created the kind of word-of-mouth publicity for his goods that is the most difficult achievement in the business of advertising. It caused so deep and lasting an impression, that in some sections it has persisted through at least six decades. The adver-

tising moral is: Get people to *talk* your brand.

The evolution of the Arbuckle and other notable package coffees is shown by illustrations. Several concerns blazed new trails that have since been picked up and followed by competing brands.

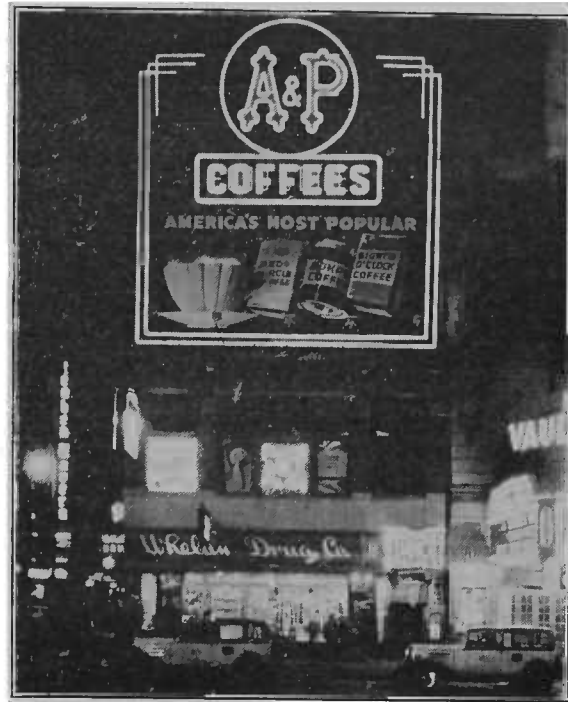
Among the many long-established advertised package-coffee successes may be mentioned:

Arbuckle's "Yuban" and "Ariosa"; McLaughlin's "XXXX"; Chase & Sanborn's "Seal Brand"; Dwinell-Wright's "White House"; B. Fischer & Company's "Hotel Astor"; Brownell & Field's "Autocrat"; Scull's "Boscul"; Seeman Brothers' "White Rose"; Blanke's "Faust"; Baker's "Barrington Hall"; Woolson Spice Company's "Golden Sun"; Kroneberger's "Old Reserve"; Leggett's "Na-

bob"; Clossett & Dever's "Golden West"; R. C. Williams' "Royal Scarlet"; Merchants Coffee Company's "Alameda"; Nash-Smith Tea and Coffee Company's "Wedding Breakfast"; J. A. Folger & Company's "Golden Gate"; Ennis Hanley Blackburn Coffee Company's "Golden Wedding"; M. J. Brandenstein & Company's "M. J. B."; Hills Brothers' "Red Can," and the General Foods Corporation's "Maxwell House."

It was estimated that the amount of money spent by the larger coffee roasters upon all forms of publicity in the United States in 1933 was about \$6,000,000.

Experience has proven that a package coffee, to be successful, must have back of it expert knowledge of buying, blending, roasting, and packing, as well as an efficient sales force. These things are essential: (1) a quality product; (2) a good trade-mark name and label; (3) an efficient package. With these, an intelligently planned and carefully executed advertising and sales campaign will spell success. Such a campaign comprehends advertising directed to the dealer and to the consumer. It may include all the approved forms of publicity, such as newspapers, magazines,



A & P "SPECTACULAR" NIGHT DISPLAY, BROADWAY AND 47TH STREET, NEW YORK

billboards, electric signs, motion pictures, radio, demonstrations, and samples. One phase of trade advertising which must not



A GROUP OF TRADE PAPER COFFEE ADVERTISEMENTS

**This Time** « « «  
**Try Coffees From Central America**

Twice the richness  
 ... twice the flavor  
 Never "thin" or "flat"  
 or bitter



**FOLGER'S COFFEE**



*Why That Coffee Taste Like This*

A SAN FRANCISCO PACKER'S "ATMOSPHERE" COPY

be overlooked is dealer helps. The extent to which the roaster-packer, or the promoter of a new package coffee, should utilize the various advertising media or go into dealer helps must, of course, depend upon the size of the advertising appropriation.

Many roaster-packers supply grocers handling their coffee with dealer helps in the shape of weather-proof metal signs for outside display, display racks, store and window display signs, cut-outs, blotters, consumer booklets, newspaper electros, motion pictures, demonstrations, samples, etc. Dealer-selling schemes based on points have also been found helpful in promoting sales.

*Advertising to the Trade*

Until a comparatively recent date, the green coffee importer, selling the roasting trade, has not realized the need of advertising. He has inclined to the belief that he did not need to advertise, because, in most instances, green coffee is not sold by the mark; and, to a certain extent, price has been the determining factor.

During late years, however, many green coffee firms have come to realize that there

is a good-will element that enters into the equation which can be fostered by the intelligent use of advertising space in the coffee roaster's trade journal. Also, a few importers are now featuring trade marks in their advertising, thus building up a tangible trade mark asset in addition to good will.

For a number of years the green coffee trade used the business card type of advertisement; but some are now utilizing a more up-to-date style of copy, as typified by the reproduction of trade paper advertisements on page 479.

Advertising campaigns in behalf of package coffees can not be fully effective without the proper use of trade publications. Advertising in the dealer's paper has many advantages. It is good missionary work for the salesman. It creates confidence in the mind of the dealer. It is an excellent means for demonstrating to the retailer that he is being considered in the scheme of distribution—that no attempt is being made to force the goods upon him through consumer advertising alone. Trade paper advertising also offers the packer the opportunity to acquaint the dealer with



*She's been coming to coffee headquarters for 75 years*

"Men America" long ago discovered that the finest coffee at the lowest possible prices were to be found at A & P. And since 1871, more and more people have been buying, drinking, and enjoying A & P Coffee until today A & P is the world's largest coffee roaster.

**JUST PEOPLE DRINK A & P COFFEE BECAUSE THERE IS NO BETTER COFFEE AT ANY PRICE.**



Day by day new recruits join this great army of coffee lovers... come to coffee headquarters for A & P's fine Coffees at money-saving prices... for A & P Coffees freshly roasted and ground correctly at the moment of purchase to save any method of making... here is a personal coffee service... you are still in search of the perfect cup of coffee—come to A & P.

**A & P FOOD STORES** 

A & P INSTITUTIONAL TYPE COPY



## The Maintenance of Quality. Industry's Unavoidable Obligation

ANY BUSINESS THAT PERMANENTLY SUCCEEDS MUST BE FOUNDED ON PRINCIPLE, HONESTY, FAIR DEALING, AND FULL VALUE FOR THE PRICE ASKED. FROM THESE PRINCIPLES NO DEVIATION OR UNWISDOM CAN EVER BE EXPECTED.

In such a period as the one through which we are passing, manufacturers and merchants are confronted with many problems. In solving the solution there is often strong pressure to mean the expenditure that in normal times never could be considered. That sense of this competition in the appearance on the market of unretained products, put out by means of "inferior substitution."

Every successful business in America in the times that have produced even after care and from generations in generations—retained from a small beginning, and built on an ideal. That ideal has always included a self-imposed obligation to keep faith with the public by maintaining quality regardless of conditions. To reduce an established quality, without notice to the public, is to violate that obligation to the consumer.

The coffee business of Hills Bros. started with an ideal. Through good times and bad that ideal has never been violated. To it, all subsequent success must be credited.



**GROUND RIGHT TO TASTE RIGHT**

The coffee, beans or granules for coffee are selected and blended in the best of the world's coffee-growing countries. The coffee is then roasted in the best of the world's roasting plants. The coffee is then packed in the best of the world's packing plants. The coffee is then packed in the best of the world's packing plants. The coffee is then packed in the best of the world's packing plants.

**HILLS BROS COFFEE**  
THE LARGEST SELLING BRAND FROM CHICAGO TO THE PACIFIC

MINNEAPOLIS CHICAGO ST. LOUIS ST. PAUL CLEVELAND CINCINNATI

**A SAN FRANCISCO PACKER'S QUALITY APPEAL**

the selling points in favor of the brand advertised, thus saving the time of the salesman. An increasing number of coffee packers are now using the advertising columns of trade papers, and some typical advertisements are reproduced herewith.

*Advertising by Various Mediums*

Billboard and other outdoor advertising, also car cards, are being used to a considerable extent for coffee publicity. Painted outdoor signs have been the backbone of one middle-west roaster's campaign for a number of years. Both car cards and billboards are growing in popularity because they enable the coffee packer to reproduce his package in its natural colors and also permit striking displays. Such firms as Arbuckle Brothers, New York; Hills Brothers, San Francisco; Maxwell House Products Company, Inc., Brooklyn; Seeman Brothers, New York; B. Fischer & Co., New York; Hanley & Kinsella Coffee and Spice Company, St. Louis; Jos. Martinson, New York; Andresen-Ryan Company, Duluth; Brownell & Field Company, Providence, and many others are consistent users of this character of advertising. Electric signs also have proved effective for coffee advertising. Reproductions of some

characteristic outdoor, car-card, and electric advertisements are shown in these pages.

Motion pictures are considerably used in coffee advertising, more especially in connection with campaigns conducted by coffee-producing countries. The Brazilian-American Coffee Promotion Committee made a coffee film which was loaned to coffee roasters to be shown at local theatres, before retail grocer groups, and at educational institutions. The National Federation of Coffee Growers of Colombia is now distributing a motion picture called "The Land of Coffee." It shows the coffee-growing and preparation processes in Colombia and is being loaned to roasters and others for exhibition purposes.

The Great Atlantic and Pacific Tea Company has circulated two films dealing with the preparation of coffee in Colombia, and also has a picture showing coffee handling in the United States for circulation within its own organization.

In showing these motion pictures at theatres and before other consumer groups it is customary for the local roaster to include a trailer advertising his particular brands.

## SPEED can give you Fresh Coffee—free from Rancid Taste

**An Expensive Package is not necessary**

*Years of experience in selecting and blending coffee stand behind the famous Chase & Sanborn quality. The world's choicest coffee beans are skillfully blended to create the perfect flavor that has been a favorite with coffee lovers for 70 years.*

**SHOULD** from the rushing of time. That's the way coffee should be enjoyed. That's the way it is healthful.

The very best coffee in the world loses its freshness, flavor and fragrance as time goes by. This is what Chase & Sanborn found after very careful research by eminent scientists. And so we invented Dated Coffee six years ago.

When you buy Chase & Sanborn's

**Dating**—permits this new package. Effects a SAVING which we pass on to you



Copyright, 1931, by The National Coffee Association, Inc.

**CHASE & SANBORN MAGAZINE COPY STRESSING COFFEE FRESHNESS**

CHASE & SANBORN MAGAZINE COPY STRESSING COFFEE FRESHNESS

a NEW All-china coffee maker that is

## AUTOMATIC!



**FOLGER'S**  
ALL CHINA  
AUTOMATIC  
DRIP COFFEE MAKER

Correct timing is VITAL in making PERFECT coffee

**COSTE YOU LESS THAN 1/2 THE REAL VALUE**

FOLGER'S COFFEE COMPANY

### How to make good coffee everytime



Only 3 things are necessary... (text continues)



**Folger's Drip Coffee**



But they all select this  
NEW TRIPLEX ALL PURPOSE GRIND

**White Rose COFFEE**

TRIPLEX GRIND

GROUP OF COFFEE ADVERTISEMENTS FEATURING CORRECT BREWING

Opinion in the United States is divided as to the value of the radio as an advertising medium, yet prominent coffee roasters spent \$2,264,025 for broadcasting facilities in 1933, plus the cost of the programs and plus many "spot" or local broadcasts by smaller concerns.

Over the National Broadcasting Company's basic "Red" network of twenty-one large cities east of the Rockies, the cost is \$7,120 per hour, while a national hook-up of sixty-five outlets, over the "Red" network costs \$15,200 per hour. The same company's basic "Blue" network of eighteen outlets costs \$6,120, and a national hook-up of 62 cities totals \$14,200 an hour.

Over the Columbia Broadcasting System, the basic network of twenty-three radio stations in the East and Midwest costs \$7,025 per hour in the evening and \$3,516 in the day time. The charge per night hour for a coast-to-coast hook-up—93 outlets—is \$17,575, and the day rate is \$8,815.

All of the charges mentioned are for radio time, only, and do not include cost of the programs. The orchestral program of the "A & P Gypsies" costs its sponsors, the Great Atlantic & Pacific Tea Company, \$3,000 weekly in addition to the cost of the radio time.

Commercial talking pictures cost their sponsors from \$5,000 to \$10,000 to produce. And added to this is a fee of \$5.00 per thousand of circulation based on box-office receipts. The average circulation per

change of program for a coast-to-coast showing is 5,000,000.

### Bureau of Coffee Information

The Bureau of Coffee Information, New York City, has been promoting interest in coffee in the United States, through publicity, since June, 1931. The American Can Company, sponsors of the Bureau, decided that more coffee would be consumed if the public knew more about it, particu-

### RADIO-TIME EXPENDITURES

By Prominent U. S. Coffee, Tea, etc., Packers in 1933\*  
(Cost of Programs Not Included)

Beechnut Packing Company .....	\$ 52,584
California Packing Corporation—	
Del Monte coffee .....	85,814
George W. Caswell Company—coffee....	47,011
J. A. Folger & Co.—coffee.....	82,581
General Foods Corporation—	
Maxwell House Coffee .....	571,330
Instant and Cereal Postum .....	90,628
M. J. B. Coffee .....	65,976
Standard Brands, Inc.—	
Chase & Sanborn Coffee .....	657,333
Tender Leaf Tea .....	93,800
Sussman, Wormser & Co.—	
Coffee and food products .....	11,480
G. Washington Refining Company—	
Instant coffee .....	106,820
R. B. Davis & Co.—Cocomalt .....	120,392
D. Ghirardelli Company—	
Cocoa and Chocolate .....	10,262
Horlick's Malted Milk Company—	
Malted milk .....	234,486
Welch Grape Juice Company—	
Grape Juice .....	33,528
	<b>\$2,264,025</b>

\*Compiled from figures published by the National Broadcasting Company, Inc.



PUBLICITY MATERIAL DISTRIBUTED BY THE BUREAU OF COFFEE INFORMATION, NEW YORK

(1) Booklet prepared for geography classes, grades 5-8. (2) "The Coffee Problem," a reprint for the institutional manager who makes coffee in large quantities. (3) "The Story of Coffee," for use in the schools. (4) "Coffee Facts for Homemakers" tells the story of coffee for adults. (5) Coffee exhibit, consisting of vials containing coffee berries, green coffees and roasted coffee; the stand fits into (6) a standard 1 lb. vacuum can prepared for the schools. (7) Sheets about coffee-growing countries for pupils' notebooks. (8) and (9) Reprints of scientific information sent to colleges. (10) Wall chart for teachers.

larly if more people realized the importance of using fresh coffee.

The Bureau works largely through educational institutions, offering, without charge, publicity material about the coffee countries, arranged for studies in geography classes, showing how coffee is planted, grown, gathered, roasted, and distributed; also how it should be brewed. The scientific

aspects of coffee are set forth, including the results of tests with coffee put up in vacuum tins, demonstrating the effectiveness of this packaging process for maintaining coffee freshness. The Bureau states that, up to June, 1935, it had sent out over 250,000 pounds of printed matter to educational institutions in various parts of the country—and all of it upon request.



"CUT-OUT" COFFEE WINDOW DISPLAY  
This Coffee-Window background, about 4 feet x 3 feet in size and folding like a three-leaf screen, shows a type of dealer help supplied by many packers.

### Advertising by Retailers

Coffee advertising by various types of retail dealers and chains constitutes an increasingly important class of coffee publicity in all parts of the United States, but especially in large cities.

When retailers analyze the people to whom they sell coffee, they usually find three types. First, there is the woman who thinks she is an expert judge of coffee, but who is unable to find anything to suit her cultivated taste. Then there is the new housewife, possibly a bride of a few months, who knows very little about coffee, but wants to find a good blend that she and her husband will like. The third is the most acceptable class, the satisfied people who have found coffee that delights them, day after day.

W. Harry Longe, a Texas retailer, has prepared the following "ready made" copy appeals for the three classes. To "Mrs. Know-it-all-about-Coffee," this style has been found effective:

#### IMPROVE THE COFFEE AND YOU IMPROVE THE MEAL

The corner of the table that holds the coffee pot is the balancing point of your dinner. If the coffee is a "little off" for some reason or other—probably it's the coffee's own fault—things don't seem as good as they might; but when it is "up to taste" the meal is a pleasure from start to finish. If the "balancing point" is giving you trouble, let ANY BLEND Coffee properly regulate it for you. 35 cents, three pounds for \$1.

ANY TEA & COFFEE COMPANY

For the good lady who is anxious to find a suitable blend of coffee, and who desires information, this is a good appeal:

#### A SUCCESSFUL SELECTION

of the coffee that goes into the every-morning cup will arrive on the day when ANY BLEND is first purchased. Many homes have been without such a success now for a long time, but, of course, they didn't know of ANY BLEND—and even now it is hard to really know ANY BLEND till you try it. That is why we seem to insist that you ask for an introduction by ordering a pound.

ANY BLEND TEA & COFFEE COMPANY

Taking both classes and dealing with them alike:

#### "BLENDED TO BALANCE"

is a good descriptive phrase of ANY BLEND coffee, for care is taken in the preparation that the strength does not overpower the flavor. The aim of the blender is to get an acceptable and delightful drinking quality. He has been more than successful, as you will see when you try ANY BLEND. 35 cents, three pounds for \$1.

ANY BLEND TEA & COFFEE COMPANY

The satisfied class, of course, is not averse to making a change, and it is well, occasionally, for the dealer to let his own satisfied customers know he still believes in his goods. The argument might take this form:

#### A SERVICE THAT SAVES

is the serving of ANY BLEND, when coffee is desired. ANY BLEND saves many things. It saves worry, for it is always uniform in flavor and strength. It saves time, for when you order ANY BLEND we grind it just as fine or just as coarse as your percolator or pot demands. ANY BLEND also saves expense, because there is no waste, as you know just how much to use, every time, to make a certain number of cups. 35 cents, three pounds for \$1.

ANY TEA & COFFEE COMPANY

Again, possible new customers may listen to this appeal:

#### TO PROVE YOUR APPROVAL

of ANY BLEND coffee, you are asked to try just one pound. We know you will like it, for it is blended and roasted and ground as an exceptional coffee should be, with the care that a good coffee demands. Prove to yourself that you approve of this method of preparing coffee. 35 cents, three pounds for \$1.

ANY TEA & COFFEE COMPANY

In some households the cook is permitted to do the ordering, and usually the cook does not read the daily papers with an eye for coffee ads. To reach this individual through her mistress:



## TEACHING COFFEE HISTORY TO THE YOUNG THROUGH THE DRAMA

The above scenes are from a school presentation of a coffee play entitled "The Song of the Coffee Bird." The play was distributed by the Bureau of Coffee Information, New York to educational institutions. Some 50,000 copies of the play have been sent out. The scenes pictured are: (1) The command. (2) The cure. (3) The magic coffee tree. (4) The presentation of the perfect gift, coffee. (5) The destiny fulfilled.

## CAN YOU NAME YOUR COFFEE?

or is it one of those many unknown brands that comes from the store at the order of your cook? Let the cook do the ordering, for you are lucky if you have one you can rely upon, but tell her you prefer ANY BLEND to the No-Name Blend you may now be using. ANY BLEND has one distinct advantage over all others; it is freshly roasted. Tell the kitchen-lady, now, to order ANY BLEND.

ANY TEA & COFFEE COMPANY

*Advertising by Government Propaganda*

Advertising coffee by government propaganda has been indulged in with more or less success by the British government in behalf of certain of its colonial possessions; by the French and the Dutch; by Puerto Rico, Costa Rica, Guatemala, Colombia, and Brazil. The markets most cultivated have been France, Germany, Austria, Czechoslovakia, Belgium, Scandinavia, and the United States.

Great Britain began the development of coffee cultivation in its colonies in 1730. Parliament first reduced the inland duties. In many ways it has since sought to encourage British-grown coffee, building up a favoritism for it that is still reflected in Mincing Lane quotations. The Netherlands government did the same thing for Java and Sumatra; and France rendered a similar service to her own colonies.

Since Puerto Rico became a part of the United States, several attempts have been made by the island government and the planters to popularize Puerto Rico coffee in the United States. Scott Truxtun opened a government agency in New York in 1905. Acting upon the counsel and advice of the author, he prosecuted for several years a vigorous campaign in behalf of the Puerto Rico Planters' Protective Association. The method followed for coffee was to appoint official brokers, and to certify the genuineness of the product. Owing to insufficient





A Swedish Wall Poster  
in Black and White

funds and the number of different products for which publicity was sought, the coffee campaign was only moderately successful.

Mortimer Remington, formerly with the J. Walter Thompson Company, was appointed in 1912 commercial agent for the Puerto Rico Association, composed of island producers and merchants. Some effective advertising in behalf of Puerto Rico coffee was done in the metropolitan district, where a number of high-class grocers were prevailed upon to stock the product, which was packed under seal of the association. As before, however, the other products handled—including cigars, grape-fruit, pineapples, etc.—handicapped the work on coffee, and the enterprise was abandoned. Subsequent efforts by the Washington government to assist the Puerto Ricans in evolving a practical plan to extend their coffee market in the United States came to naught because of too much "politics."

Beginning with the Panama-Pacific Exposition in San Francisco in 1915, the government of Guatemala started a propaganda for its coffee in the United States. This was because the European market, which had up till then absorbed seventy-five per cent of its product, was closed to it, owing to the World War. E. H. O'Brien, a coffee broker of San Francisco, directed the publicity. Some full pages were used in newspapers, but the main efforts were directed at the coffee-roasting trade. The campaign, so far as it went, was highly successful.

Costa Rica also gave special encouragement to coffee-trade interests that offered to expand the United States market for Costa Rica coffee during the World War.

The National Federation of Coffee Growers of Colombia, comprising planters, brokers, and exporters, with headquarters at Bogota, began publicity work in the United States in June, 1930, opening an office at New York, in charge of Mr. Miguel Lopez Pumarejo. In 1932, a branch was opened

at San Francisco, and in 1934 a representative was assigned to New Orleans, thus establishing points of contact between the Federation and the three most important coffee importing cities in the United States. Mr. Lopez was succeeded by Mr. Miguel Samper Herrera at New York in March, 1935.

In its work in helping to increase the consumption of Colombian coffees in the United States, the Federation conducts educational campaigns on coffee, and supplies impartial information to interested persons who buy or sell the product.

Besides booklets, educational films, coffee, and other forms of propa-

The Secret of  
Good Coffee is its—

Freshness!

So every possible means is employed by us to get it to you in the shortest possible time. FRESHLY roasted, delivered FRESH to our stores twice a week and kept FRESH while in our stores.

*You insist upon the butter, eggs, milk and other foods you buy being FRESH—Why not Coffee?*

We have analyzed coffee preferences for over forty-three years and the result of our findings is embodied in our three favorite and popular blends.

We ask you to try one of these blends of FRESH coffee, madam, give it a test for a week or so, compare it with the one you are now using and we feel sure that you will agree that for FRESHNESS, Quality and economy it is unmatchable.

*Our Three Favorite Blends—Specially Priced!*

**21c Victor Coffee 19c**  
Ar. all Santos Coffee of exceptional quality. Mild and Mellow. Ground to your order while you wait.

**23c ASCO Coffee 21c**  
A blend of the finest South American coffees—decidedly different and pleasing flavor. Ground to your order while you wait.

**27c Acme Coffee 25c**  
Certified Arabian Mocha and Java and the finest South American Coffee skillfully blended. Packed in an improved vacuum can—keeping the Coffee freshness and flavor intact.

Where Quality Counts, Your Money Goes Furthest.

**AMERICAN STORES CO. AMERICAN**

#### TYPICAL CHAIN-STORE NEWSPAPER COPY

at San Francisco, and in 1934 a representative was assigned to New Orleans, thus establishing points of contact between the Federation and the three most important coffee importing cities in the United States. Mr. Lopez was succeeded by Mr. Miguel Samper Herrera at New York in March, 1935.

In its work in helping to increase the consumption of Colombian coffees in the United States, the Federation conducts educational campaigns on coffee, and supplies impartial information to interested persons who buy or sell the product.

Besides booklets, educational films, coffee, and other forms of propa-



Wall Poster in Color,  
Stockholm, Sweden



GROCERY STORE WINDOW DISPLAY, FEATURING "BEECH NUT" COFFEE

ganda, the Federation has made a statistical study of coffee in Colombia, and in the other producing and consuming countries. The Federation keeps in close touch with the trade in order to extend every possible cooperation. It establishes contacts between prospective importers and exporters of Colombian coffee. It also stimulates constructive criticism, striving thereby to improve all phases of the coffee industry in Colombia. The New York office releases a weekly bulletin showing the statistical position and other information bearing upon the coffee situation in Colombia.

The Federation has published, for free distribution, the following booklets: "The Land of Coffee," "The Why and How of a Good Cup of Coffee," "The Coffee Industry of Colombia," "Iced Coffee and Some Factors Affecting Quality," "Acidity of Roasted Coffee," and "The Correctness of Grind in Relation to Coffee Brewing." The latter was worked out in close collaboration with the Associated Coffee Industries of America. Photographs of coffee trees and plantations are also distributed, and radio broadcasting has been used.

The following motion pictures have been made by the Federation and are lent to

trade and educational institutions: "The Land of Coffee," "The Lure of the Andes," and "Coffee from the Clouds." Regular advertisements are placed in several trade magazines.

Contracts have been made with important European houses for the exclusive sale of Colombian coffees, which are extensively advertised in public conveyances, in magazines, and on billboards. A booklet has been issued in French under the title "Son altesse cordiale le café." The Federation has an office in Paris which serves the same purpose and renders equal service as the New York office, not only in France but also throughout Europe, with the object of establishing new channels of distribution for Colombian coffees. Mr. R. Pinto

NOVELTY MUSICAL ADVERTISEMENT

Coffee is Like a Friend, Tiny  
WHEN YOU GET A GOOD ONE, STICK TO IT!

MAXWELL HOUSE COFFEE  
GOOD TO THE LAST DROP

A "MAXWELL HOUSE" MAGAZINE ADVERTISEMENT

Valderrama is director of the Paris office, and Mr. José Medina is traveling representative for the Federation in Europe.

Colombian coffee propaganda in France began in 1934 and had the effect of doubling the French imports of Colombian coffee in the first year. The policy followed has been to stress quality and not attack the habits and customs of the French merchants, but rather to collaborate closely with existing organizations and respect the rules of their syndicates. "Café suave de Colombie" is featured prominently at exhibitions and epicures' clubs. The Federation has worked chiefly through high-class food stores, whose clientele can pay the price of good coffee, and their printed matter points out that high-quality Colombian coffee can be secured throughout the year.

Costa Rica exhibited coffee and other products at the Chicago world's fair in 1933. The exhibit took the form of a refreshment garden with a counter and tables where coffee, cocoa, and confections were features of a luncheon menu.

Puerto Rico also exhibited coffee and other products at the Chicago fair. The coffee was roasted, ground and packed in

one-pound cans inside a railed enclosure, where all might see—and breathe the coffee aroma.

São Paulo, Brazil, began in 1908 to make propaganda for its coffee by subsidizing companies and individuals in consuming countries to promote consumption of the Brazil product. A contract was entered into between the state of São Paulo and the coffee firms of E. Johnston & Company and Joseph Travers & Son, of London, to exploit Brazil coffee in the United Kingdom. Similar contracts were made with coffee firms in other European countries, notably in Italy and France. The subsidies were for five years and took the form of cash and coffee. The English company was known as the "State of São Paulo (Brazil) Pure Coffee Company, Ltd." Fifty thousand pounds sterling was granted this enterprise, which roasted and packed a brand known as "Fazenda"; promoted demonstrations at grocers' exhibitions; and advertised in somewhat limited fashion. The general effect upon the consumption of coffee in England was negligible, however, although at one time some five thousand grocers were said to have stocked the "Fazenda" brand. A feature of this propaganda was the use of the "Tricolorator," an American device since better known in the United States, to insure correct making of the beverage. Brazil also made propaganda for its coffee in Japan, in 1915, as part of certain undertakings involving the immigration of Japanese laborers to Brazil.

The Comité Français du Café was formed in Paris in July, 1921, to co-operate with Brazil in an enterprise designed to increase the consumption of coffee in France.

The chief fault in most of the coffee

"THE AROMA TEST"

MARTINSON'S COFFEE

MAGAZINE ADVERTISEMENT STRESSING AROMA



WINDOW DISPLAY SUPPLIED TO DEALERS BY A SAN FRANCISCO PACKER

propagandas here and abroad has been the doubtful practice of subsidizing particular coffee concerns instead of spending the funds in a manner designed to distribute the benefits among the trade as a whole. This mistake, and local politics in the producing countries, have made for ultimate failure. A notable exception has been propaganda for Brazil coffee in the United States, begun in 1919 and continued until 1925, where all the various interests, the São Paulo government, the growers, exporters, importers, roasters, jobbers, and dealers, co-operated in a plan of campaign to advertise coffee *per se*, and not to secure special privilege to any individual, house, or group.

#### *Joint Coffee Trade Publicity Campaign*

Thirty-two years ago the author began an agitation for co-operative advertising by the coffee trade. He suggested as a slogan, "Tell the truth about coffee," and it was gratifying to find that many of his original ideas were embodied in the 1919-25 joint coffee trade publicity campaign.

The coffee roasters organized their national association in 1911. The author of this work urged that co-operative advertis-

ing based upon scientific research should be done by the roasters themselves independently of the growers; but it was found impracticable to unite diverging interests on such an issue, and so the leaders of the movement bent all their energies toward promoting a campaign that would be backed jointly by growers and distributors. Brazil, the source of nearly three-quarters of the world's coffee, was the logical ally; and an appeal was made to the planters of that country. The planters of the state of São Paulo, who produce more than one-half of all coffee used in the United States, were the first to appreciate the propaganda idea. After their attempts to interest the national government failed, the São Paulo coffee men founded the *Sociedade Promotora da Defesa do Café* (Society to Promote the Defense of Coffee), and persuaded their state legislature to pass a law taxing every bag of coffee shipped from the plantations of that state in a period of four years. This tax, amounting at first to one hundred reis per bag of 132 pounds, or about two and one-half cents United States money at even exchange rate, and to double that amount for three years after 1923, was collected by the railroads from the shippers, and turned over to the *Sociedade*.



NOVELTY COFFEE-DELIVERY MOTOR CAR

The Brazilian Society sent Mr. Theodore Langgaard de Menezes to the United States to conclude arrangements; and on March 4, 1918, in New York, a pact was signed whereby São Paulo was to contribute to the publicity campaign in the United States approximately \$960,000 at the rate of \$240,000 a year for four years; and the members of the trade in the United States were to contribute altogether \$150,000. So encouraging were the results of the four-year campaign, that it was carried on until 1925.

Supervision of the advertising in the United States was delegated to five men: Ross W. Weir, of New York; F. J. Ach, of Dayton, Ohio; and George S. Wright, of Boston, roasters; and William Bayne, Jr., and C. H. Stoffregen, both of New York, green-coffee men. The committee organized with Mr. Weir as chairman, Mr. Wright as treasurer, and Mr. Stoffregen as secretary. C. W. Brand of Cleveland, president of the National Coffee Roasters Association, attended the committee meetings by invitation, and assisted in determining the policies of the campaign. Headquarters were established in New York with Felix Coste as secretary-manager, and Allan P. Ames as publicity director. N. W. Ayer & Son, advertising agents of Philadelphia, who had engineered the plan of campaign, handled the advertising account.

Newspapers, magazine, and trade paper advertising began in 1919, along broadly educational lines, as the nucleus of the campaign. Its effect was amplified by the advertisements of private brands and other kinds of consumer publicity recognized as essential factors in a national advertising effort.

In 1920, twenty-two thousand, five hundred dollars of the American fund was ap-

propriated for a scientific research which was conducted by Prof. S. C. Prescott at the Massachusetts Institute of Technology whose final report, made and widely published in 1923, was that coffee is a wholesome, helpful, satisfying drink for the great majority of people.

Another activity of the Joint Coffee Trade Campaign was the organization of the Coffee Club, established for the purpose of educating the consumer through constructive teamwork by the roasters' and jobbers' salesmen and the retail dealers. The Club published a monthly bulletin in newspaper form which had a circulation of 27,000 among wholesalers, salesmen, and retail dealers. Through the instrumentality of the Coffee Club, the committee distributed 50,000 transparent signs for dealers' windows, and 5,000 bronze Coffee Club buttons for salesmen.

The committee published, at various times, six booklets which reached a total circulation of more than one and a half million copies in American homes and schools. The booklets were sold at cost to the trade, who distributed them to their customers and to domestic science teachers in the schools.

Brand advertising increased over three hundred per cent during the campaign, under encouragement from the committee for roasters to tie-up their local advertising with the national magazine and newspaper campaign.

The results of the 1919-25 Joint Coffee Trade Publicity Campaign were regarded as highly satisfactory. And as the campaign did not discriminate against the coffees of countries other than Brazil, all gained in sales, although Brazil naturally profited most.



COLORED STORE CARDS USED IN ENGLAND





A FEW WELL-KNOWN EUROPEAN COFFEE BRANDS

During the week of March 29 to April 4, 1920, the committee organized and financed the third national coffee week, which was observed by retailers throughout the country. The feature of this week was a window-trimming contest for which prizes of \$2,000 were distributed among several hundred grocers. The contest resulted in displays of coffee in nearly 10,000 grocery windows, and greatly increased the sale and consumption of coffee during this period.

The United States fund also financed the production and distribution of a coffee motion picture, 128 prints of which were sold to roasters, who exhibited them throughout the country.

#### *Brazil Propaganda, 1927-31*

During the celebration of 200 Years of Coffee in Brazil, 1927, plans were perfected for a policy of coffee defense which included further propaganda abroad for Brazil coffee. With the help and encouragement of the national government, Dr. Washington Luiz, President; the state of São Paulo, Dr. Julio Prestes, President; and Dr. Mario Rolim Telles, Secretary of Finance of the state of São Paulo and pres-

ident of the São Paulo Coffee Institute, intensive propaganda was started in all the principal coffee-consuming countries. Operations were under the control of the São Paulo Coffee Institute and, in general, contracts were made with resident firms or institutions in the respective countries, with funds allotted in proportion to the work to be done.

The contracts, while flexible to varying conditions in different countries, required the contractors to establish and maintain, in suitable localities, coffee stands or bars equipped for roasting, grinding, and serving Brazil coffee exclusively. A further requirement was that the stands be kept in rigorously hygienic condition, so as to attract the public; and both the interiors and exteriors of the places were to be decorated with slogans and allegorical designs eulogizing the tonic properties of coffee and urging its daily use. The phrase "Brazil Coffee" was to appear constantly.

Free sample distributions to private homes and at fairs, were features of the campaign, and films illustrating the culture of coffee in Brazil were exhibited. In addition, billboards, circulars, and the radio were used whenever possible.

By the end of 1927 contracts were signed



**BRAZIL COFFEE PROPAGANDA IN DENMARK**

In the handsome coffee house maintained by the Brasiliansk Kaffe Kompagni Aktieselstab, Copenhagen, the waitresses are dressed in the national colors of Brazil.



**DEMONSTRATING BRAZIL COFFEE WITH AN ITALIAN RAPID COFFEE-MAKING MACHINE IN CZECHOSLOVAKIA**

**HOW BRAZIL HAS STIMULATED INTEREST IN COFFEE ABROAD**

for Brazil coffee campaigns in Germany, Switzerland, Argentina, Chile, Czechoslovakia, France, Paraguay, Greece, Jugoslavia, Turkey, and Bulgaria. Others followed shortly.

The initial steps for a Brazil coffee campaign in the United States, which began in 1929 and continued into 1931, were taken late in 1928 by the São Paulo Coffee Institute as the result of agitation for a Brazil coffee campaign here by the National Coffee Trade Council, through its president, Frank C. Russell, of New York. At the request of the Institute, a committee, known as the Brazilian-American Coffee Promotion Committee, was named by Mr. Russell to handle the propaganda work, with funds resulting from a tax of 200 reis on every bag of coffee shipped from Brazil to the United States. The members of the committee were: Frank C. Russell, chairman, Hon. Sebastião Sampaio, D. N. Walker, Berent Friele, Felix Coste, John M. Hancock, R. L. Gerhart, and O. Q. Arner, secretary-treasurer.

N. W. Ayer & Son, Inc., Philadelphia, were chosen as advertising counsel, and in April, 1929, actual work began. The slogan selected for the campaign was, "Coffee—America's Favorite Drink." An educational campaign was conducted, urging the use of better grades of coffee and better preparation. Again, *The Coffee Club* periodical, which figured in the previous campaign, was filled with helpful suggestions to aid roasters, wholesalers, retailers, stewards, and others. Also, appeal was made through home-economic, dietetic, and medical teachers, and through coffee, grocery, hotel, and restaurant publications, and



A GERMAN COFFEE ADVERTISEMENT



WINDOW TRANSPARENCY, BUDAPEST, HUNGARY

daily newspapers in metropolitan centres. Among other ideas for increasing the consumption of coffee, Four O'Clock Coffee was urged for office, shop, and home.

A coffee-plantation film was widely distributed and was shown to a quarter of a million women in domestic science classes, cooking schools, clubs, and like organizations. In addition, a nation-wide radio hook-up brought the Brazil coffee message into millions of homes.

A school exhibit, consisting of a series of plates showing the growing, cultivation, picking, preparation, shipping, and roasting of coffee, was in heavy demand by school teachers.

Scientific research, begun in 1920, during the Joint Coffee Trade Publicity Campaign, was further entrusted to Dr. S. C. Prescott of the Massachusetts Institute of Technology. This covered the composition, physiological effect, and methods of preparation of coffee; methods of agriculture, picking, and curing, and related matters.

Brazil coffee propaganda elsewhere during the same period covered Argentina, Austria, Belgium, Bulgaria, Czechoslovakia, Denmark, Egypt, Finland, France, Germany, Hungary, Italy, Japan, Jugoslavia, Netherlands, Norway, Portugal, Spain, Sweden, Switzerland, and Turkey. In the European campaigns, art features along with consumer demonstrations were used with successful results.

Brazil had an impressive coffee exhibit at the Century of Progress exposition at Chicago in 1933 and 1934. In modernistic surroundings and amid attractive decorations illustrative of Brazil's chief product, thousands of free cups of coffee were served daily at a double horseshoe coffee bar. At

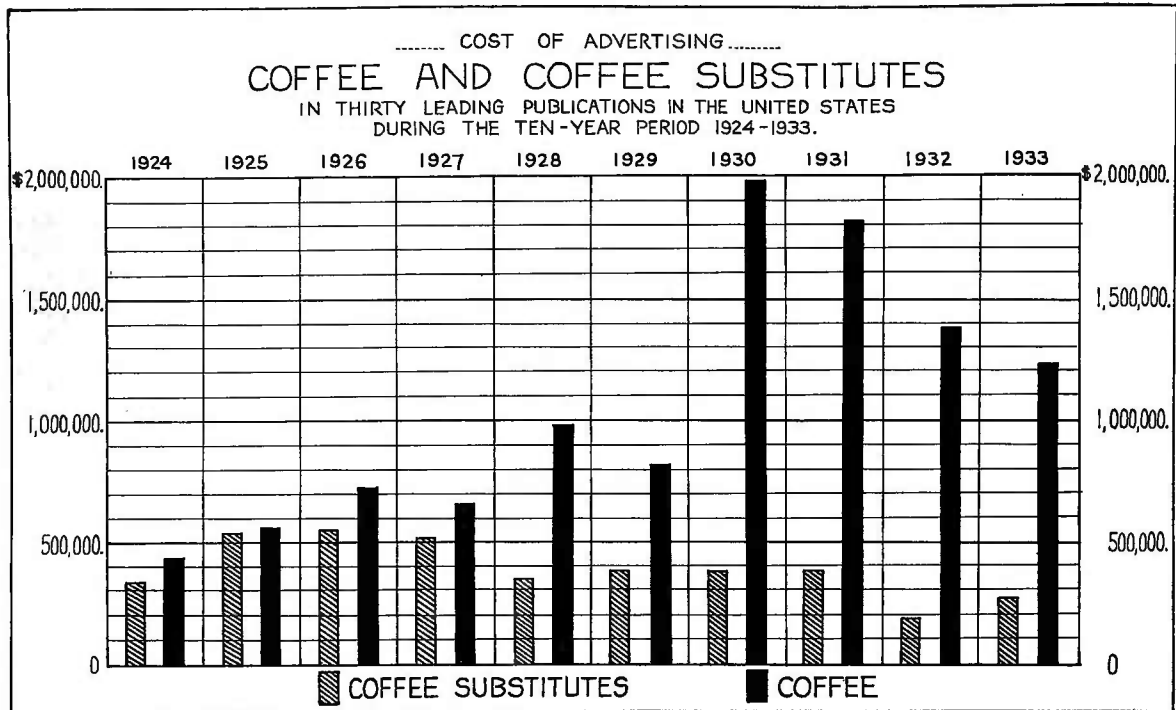


CHART SHOWING MONEY SPENT ON ADVERTISING COFFEE AND COFFEE SUBSTITUTES  
 Only advertisements printed in magazines and periodicals are included.

the same time many inviting easy chairs in the adjoining lounges, at each end of the coffee bar were always occupied by coffee drinkers. A large diorama of a São Paulo coffee plantation was a conspicuous feature of the exhibit.

Other notable exhibits of Brazil coffee in recent years were the display and demonstration of the São Paulo Coffee Institute at the Coffee Exposition, Brussels, in 1929; the exhibit at the Seville, Spain, Exposition, in 1929; and at the Brussels and Yokohama Expositions in 1935.

#### *Periodical Publicity*

The accompanying graph, shows the coffee and coffee substitute advertising expenditures in thirty leading publications in the United States during the last ten years, as checked by the Curtis Publishing Company, Philadelphia. In this group of periodicals coffee advertising increased sharply in 1930, with a corresponding upward turn of the per capita curve as shown in the per capita graph on page 495. Since 1930, both the advertising expenditures and the per capita curve show a downward trend. Coffee substitute advertising decreased considerably in the period covered by the graph. During the World-War period coffee

substitute advertising averaged about twice that of coffee in this same group of magazines.

#### *Progress of Coffee Advertising*

Reverting to the original advertisement for coffee in English, when we compare it with the latest examples of advertising art, it is of the same order of merit. But Pasqua Rosée had no advertising experts to advise him and no precedents to follow. Pasqua Rosée was a native of Smyrna, who was brought to London by a Mr. Edwards,

#### ESTIMATED TOTAL COFFEE-ADVERTISING EXPENDITURES

by twenty-three leading U. S. coffee roasters in 1933, showing the media used\*

Magazines .....	\$ 984,149
Newspapers .....	1,597,500
Radio .....	1,697,945
Outdoor .....	550,000
Car Cards .....	719,000
<b>Total .....</b>	<b>\$5,548,594</b>

\*Compiled by Erwin, Wasey & Co., New York.

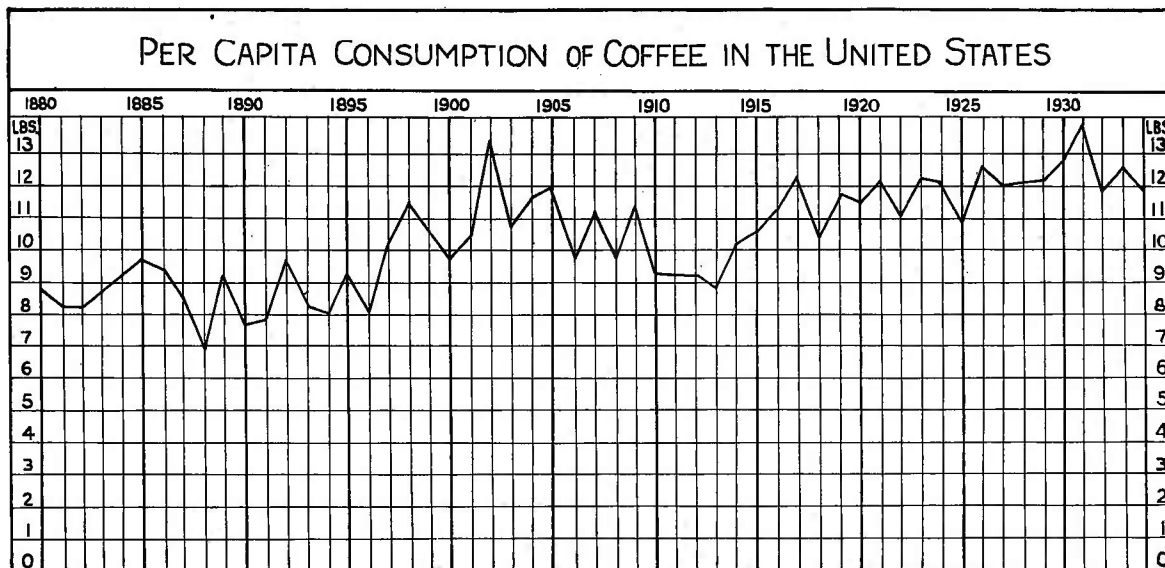


CHART SHOWING THE PER CAPITA CONSUMPTION OF COFFEE IN THE UNITED STATES

a dealer in Turkish merchandise, to whom he acted as a sort of personal servant. One of his principal duties was the preparation of Mr. Edwards' morning drink of Turkish coffee.

"But the novelty thereof," history tells us, "drawing too much company to him he [Mr. Edwards] allowed his said servant, with another of his son-in-law, to sell it publicly." So it came about that Pasqua Rosée set up a coffee house in St. Michael's Alley, Cornhill.

And since Pasqua Rosée's idea, naturally, was to acquaint the London public with the virtues and delectable qualities of the product of which his prospective customers were naturally uninformed, he put into his advertisement those facts and arguments which he felt would be most likely to attract attention, to excite interest, and to convince. If the reader will glance at Rosée's advertisement, which is reproduced on page 50, he will be struck by the well-nigh irresistible charm of his unaffected, straightforward bid for patronage. Having no advertising fetishes to warp his judgment, he told an interesting story in a natural manner, carrying conviction. It matters not that some of the virtues attributed to the drink have since been disallowed. He believed them to be true. Few there were in those days who knew the real "truth about coffee."

Even his typography, unstudied from the standpoint of modern "display," is attractive, appropriate, and exceedingly

pleasant to the eye. And since at that time there was no cereal substitute or other bugaboos to contend against, and to hinder him from doing the simple, obvious thing in advertising, he did that very thing—and did it exceedingly well.

In fact, in the historic advertisement, Pasqua Rosée set an example and established a copy standard which had a very beneficial effect on all the coffee advertising of that early date. This will be evident from a glance at the exhibits of other early advertisements in this chapter. It was not until the days of so-called "modern" advertising that coffee publicity reached low-water mark in efficiency and value. In those dark days most coffee advertisers ignored the principles discovered and applied in other lines of grocery merchandis-



"LONG DISTANCE" DISPLAY ON A BUILDING





BLACK AND WHITE REPRODUCTION OF COLORED CAR CARDS ADVERTISING COFFEE

ing. Instead of telling their public how good their product was, they actually followed the opposite course, and warned the public against the dangers of coffee drinking! Instead of saying to the public, "Coffee has many virtues, and our brand is one of the best examples," their text said in effect, "Coffee has many deleterious properties; some, or most, of which have been eliminated in our particular brand." They were, for the most part, apostles of negation.

We may well applaud the publicity work of all coffee advertisers who follow where Pasqua Rosée led—those who tell the public how good coffee is to drink and how much good it does you if you drink it. Considering the advertising and typographical resources available to the modern advertiser, it certainly should be possible for this message to be conveyed to the public with at least some of the charm of the first coffee message. Certainly, there should be an end to the negative and destructive type of advertising that benefits no one and is likely to prove least beneficial to the user of this kind of appeal.

Many in the coffee trade who have given the matter thought have often wondered why, with the wealth of material available to writers of coffee advertisements, so little has been done to make the product alluring—why so little has been done to give

atmosphere to the product. So many interesting things may be said about the history of coffee; the spread of the industry through various countries; how Brazil came to be the coffee-producing country of the world; how coffee is cultivated, harvested, and shipped; how it is stored, roasted, handled, delivered—in short, the entire process by which coffee reaches the breakfast table from the plantations of the tropics.

Simply to tell these things in an interesting, natural, convincing way makes coffee appear as a healthful, delicious drink; whereas the negative sort of advertising, which plays into the hands of the substitutes, puts coffee in the wrong light.

With the exception of one outstanding offender among the coffee roasters, the trend in coffee advertising in the United States has been toward a more constructive appeal. In 1935, and for several years prior to that date, there had been much evidence of a desire on the part of coffee packers to get away from a mere statement as to the superior merit of the advertised brand and to stress the virtues of coffee. Other talking points emphasized were correct roasting, grinding, and packaging. The importance of fresh coffee has been one of the most popular and constructive themes in coffee publicity in recent years. The quality idea is another angle that has



A STRIP OF THREE ATTRACTIVE COUNTER CARDS

been considerably developed on the part of a number of packers.

Iced coffee has received more attention in coffee publicity of late, this summer beverage being played up in alluring advertisements to prompt added coffee consumption during the summer months when normal demand declines.

The radio has become a popular medium for coffee advertising in the United States, some of the larger firms spending vast sums for broadcasts which usually take the form of orchestral and vocal entertainment with incidental reference to the featured brands. Radio advertising usually stresses the brand more than coffee, the beverage.

Booklets telling the story of coffee culture and preparation form an important adjunct of the larger coffee packers' publicity effort. Because of keen competitive conditions the dealer is also receiving more help than ever before by the wholesaler in order to facilitate moving the product off the retailer's shelf. This assistance takes the form of local newspaper advertising, car cards, window and store displays, cut-outs, etc.

In Europe, the advertising of most coffee packers deals more particularly with the merits of certain brands rather than with coffee itself. Much of the advertising is especially attractive from a typographi-

cal standpoint, being of the modernistic style.

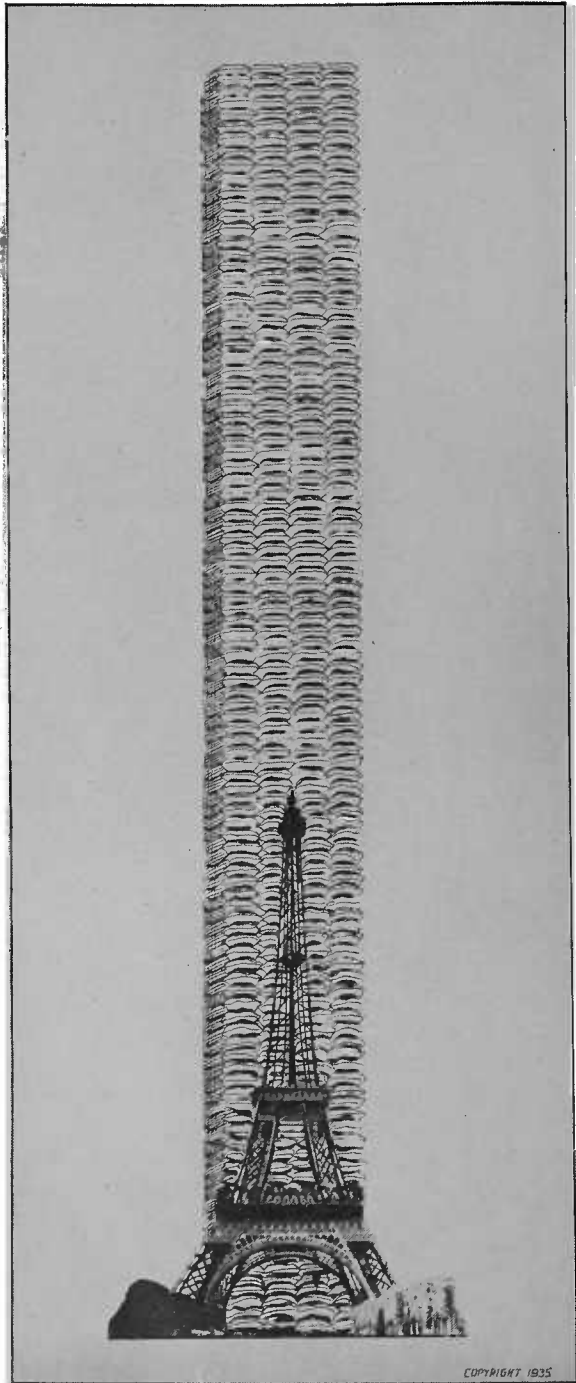
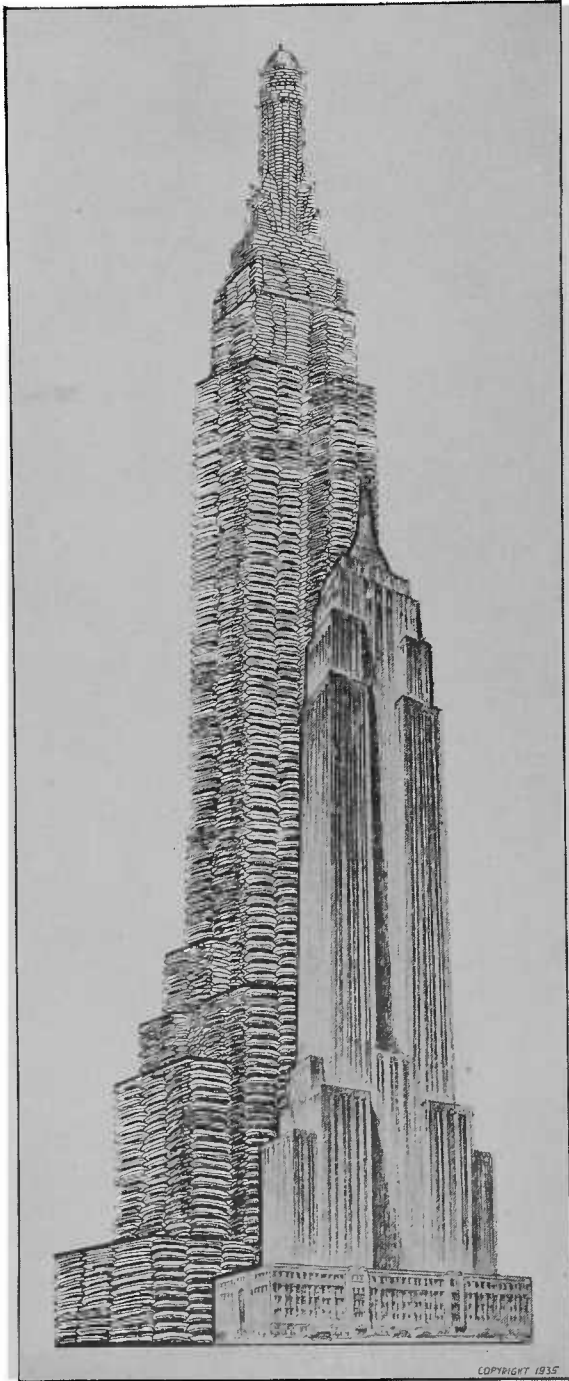
#### *Coffee Advertising Efficiency*

As in the case of tea, there has been so much misinformation published that the advertiser should be careful to avoid controversial questions and make his copy positive, not negative. His appeal should be educational in character, and based upon facts arranged in their right order. Coffee, like tea and good wine, "needs no bush." It is an ancient and honorable beverage, and has long since arrived.

Whether it is Government or association propaganda or advertising for a private brand, the right approach requires an intelligent analysis of the market before anything is done. After that, no matter what media are indicated or methods employed, the things which need stressing are these:

1. The intrinsic desirability of coffee—actual pleasure to be derived from the act of partaking of it.
2. It is a delightful medium for social intercourse—part of the essential equipment for an intimate chat or a more general assembly of friends.
3. Its proper service is a badge of social distinction—the mark of a successful hostess.

These three thoughts should be woven into the fabric of all coffee advertising; but first, last, and always, the educational note must be sounded.



### THE WORLD'S ANNUAL COFFEE SUPPLY COMPARED WITH THE EIFFEL TOWER AND THE EMPIRE STATE BUILDING

The Empire State Building, the world's loftiest office structure, is 1,248 feet high from street to the top of the tower; its main section is 1,048 feet from street to the roof of the 85th floor, with a tower 200 feet higher. Its contents equal a total of 37,000,000 cubic feet. But a tower made of an average year's supply of bags of green coffee (132 pounds each) would equal 121,800,000 cubic feet, or more than three times the bulk of the Empire State Building. In the same proportions it would rise to a height of 1,872 feet. Its dimensions would be  $\frac{1}{2}$  greater than those of the Empire State Building in every direction, the difference in height being some 624 feet. The Eiffel Tower, reaching up 1,000 feet toward the sky, would be lost in a tower made of a year's supply of bags of coffee. Such a tower would stand 2,302 feet high on a base area of 230 feet square, the size of the Eiffel's first floor.

## CHAPTER XXXIII

### THE PRODUCTION AND CONSUMPTION OF COFFEE

A STATISTICAL STUDY OF WORLD PRODUCTION OF COFFEE BY COUNTRIES—PER CAPITA FIGURES OF THE LEADING CONSUMING COUNTRIES—COFFEE-CONSUMPTION FIGURES COMPARED WITH TEA-CONSUMPTION FIGURES IN THE UNITED STATES AND THE UNITED KINGDOM—THREE CENTURIES OF COFFEE TRADING—COFFEE DRINKING IN THE UNITED STATES, PAST AND PRESENT—REVIEWING THE COFFEE TRADE OF THE UNITED STATES IN 1934

**T**HE world's yearly commercial production of coffee averages approximately two million tons. If this were all made up into the refreshing drink we get at our breakfast tables there would be enough to supply every inhabitant of the earth with seventy-five cups a year, representing a total of more than one hundred and fifty billion cups.

In terms of pounds the annual world commercial output now averages nearly four billions—an amount so large that if it were done up in one-pound paper packages six inches long and these packages were laid end to end they would form a line long enough to reach to the moon and a hundred and forty thousand miles beyond it. If this yearly production were left in the sacks in which the coffee is shipped, the total of 29,000,000 would be enough to form a broad ten-foot pavement reaching entirely across the United States, on which a man could walk steadily for five months at the rate of twenty miles a day.

The record yield of all time occurred in the crop year 1933-34 when 38,800,000 bags, or more than five billion pounds, of coffee were produced. The second largest yield was that of 1929-30, with a total of 37,677,000 bags. These figures do not include amounts consumed in producing countries, except in Brazil. For the crop year ending June 30, 1935, the output is estimated at a much smaller figure—about 23,000,000 bags.

This vast amount of coffee comes largely from the western hemisphere, and about

three-fourths of it from a single country. Directly and indirectly the task of producing, shipping, and preparing this coffee supports millions of workers, and many countries are entirely dependent on it for their prosperity and economic well being.

As shown by the table on page 500, Brazil produces much more than all the rest of the world put together. But coffee growing is general throughout tropical countries, and in most of them it constitutes one of the leading industries. As a rule, the actual amount each of these countries produces can only be estimated, as accurate figures of output are seldom compiled. But the contribution that each makes to the total world traffic in coffee can be determined by its export figures, which are obtainable in reasonably accurate and up-to-date form.

The ranking of the various coffee-producing areas of the world in the coffee export trade is shown by the table on page 502. This compilation gives coffee-export figures, in pounds, for practically every country that produces coffee for sale outside its own borders. Figures are given for the latest available year, and also for the average of the last five years for which statistics can be obtained. The figures are taken direct from the official statistics of the countries concerned.

For the most part these figures of exportation are the only statistics available to indicate the actual amount of coffee production in the countries named. The following additional data, however, will serve to show the extent to which the coffee-rais-

STATISTICAL RECORD FOR FORTY YEARS

Fiscal or Crop Year (July 1 to June 30)	Production			Deliveries			World Total <sup>1</sup> (Bags)	World Total <sup>1</sup> (Cents)
	Brazil <sup>2</sup> (Bags)	Other Countries <sup>2</sup> (Bags)	World Total (Bags)	Europe <sup>3</sup> (Bags)	United States (Bags)	World Total (Bags)		
1893-94	5,037,000	4,364,000	9,401,000	6,273,000	4,299,000	10,572,000	1894	2,146,000
1894-95	7,237,000	4,527,000	11,764,000	6,817,000	4,396,000	11,213,000	1895	3,116,000
1895-96	5,990,000	4,337,000	10,327,000	6,894,000	4,339,000	11,233,000	1896	2,588,000
1896-97	9,311,000	4,607,000	13,918,000	7,156,000	5,089,000	12,244,000	1897	3,976,000
1897-98	11,214,000	4,844,000	16,058,000	8,536,000	6,036,000	14,572,000	1898	5,436,000
1898-99	9,319,000	4,437,000	13,756,000	7,798,000	5,683,000	13,481,000	1899	6,200,000
1899-00	9,454,000	4,347,000	13,801,000	8,937,000	6,036,000	14,973,000	1900	5,841,000
1900-01	11,314,000	3,786,000	15,100,000	8,486,000	5,844,000	14,330,000	1901	6,868,000
1901-02	16,089,000	3,646,000	19,735,000	8,853,000	6,664,000	15,517,000	1902	11,261,000
1902-03	13,066,000	4,499,000	17,565,000	9,118,000	6,848,000	15,966,000	1903	11,900,000
1903-04	11,130,000	4,628,000	15,758,000	9,231,000	6,853,000	16,134,000	1904	12,361,000
1904-05	10,524,000	3,924,000	14,448,000	9,476,000	6,857,000	16,333,000	1905	11,266,000
1905-06	10,844,000	3,948,000	14,792,000	9,934,000	6,807,000	16,741,000	1906	9,637,000
1906-07	20,218,000	3,596,000	23,814,000	10,592,000	7,043,000	17,635,000	1907	16,400,000
1907-08	19,973,000	3,861,000	23,834,000	10,432,000	7,044,000	17,476,000	1908	16,380,000
1908-09	12,915,000	4,003,000	16,918,000	11,130,000	7,520,000	18,650,000	1909	14,132,000
1909-10	15,324,000	3,801,000	19,125,000	11,130,000	7,287,000	18,417,000	1910	12,821,000
1910-11	10,848,000	3,676,000	14,524,000	10,493,000	7,015,000	17,508,000	1911	13,732,000
1911-12	13,072,000	4,337,000	17,409,000	10,712,000	6,763,000	17,475,000	1912	11,048,000
1912-13	12,098,000	4,275,000	16,373,000	10,145,000	6,676,000	16,821,000	1913	10,285,000
1913-14	14,458,000	5,154,000	19,612,000	11,023,000	7,545,000	18,568,000	1914	11,302,000
1914-15	13,492,000	4,394,000	17,886,000	13,368,000	8,010,000	21,378,000	1915	7,523,000
1915-16	15,955,000	4,808,000	20,763,000	11,020,000	8,834,000	19,854,000	1916	7,328,000
1916-17	12,740,000	3,951,000	16,691,000	5,171,000	9,046,000	14,217,000	1917	7,794,000
1917-18	15,836,000	3,011,000	18,847,000	5,100,000	8,624,000	13,724,000	1918	8,783,000
1918-19	9,715,000	4,500,000	14,215,000	9,967,000	8,995,000	18,962,000	1919	10,020,000
1919-20	7,482,000	7,681,000	15,163,000	7,979,000	9,683,000	17,662,000	1920	6,910,000
1920-21	14,496,000	5,787,000	20,283,000	7,638,000	9,701,000	17,339,000	1921	8,639,000
1921-22	12,894,000	6,926,000	19,820,000	9,377,000	9,607,000	19,000,000	1922	8,577,000
1922-23	10,256,000	5,705,000	15,961,000	8,774,000	9,661,000	18,435,000	1923	5,297,000
1923-24	19,426,000	6,868,000	26,294,000	10,245,000	10,758,000	21,003,000	1924	9,612,000
1924-25	10,323,000	6,762,000	17,085,000	9,935,000	9,590,000	19,525,000	1925	6,785,000
1925-26	15,956,000	7,062,000	23,018,000	10,438,000	10,777,000	21,215,000	1926	7,324,000
1926-27	14,750,000	7,068,000	21,818,000	9,778,000	10,518,000	20,296,000	1927	7,705,000
1927-28	25,945,000	8,003,000	33,948,000	10,896,000	11,408,000	22,304,000	1928	18,232,000
1928-29	9,494,000	8,660,000	18,154,000	10,555,000	10,638,000	21,193,000	1929	14,314,000
1929-30	29,404,000	8,273,000	37,677,000	11,336,000	11,166,000	22,502,000	1930	31,403,000
1930-31	16,164,000	8,633,000	24,797,000	11,653,000	12,357,000	24,010,000	1931	28,721,000
1931-32	26,103,000	8,287,000	34,390,000	11,511,000	11,297,000	22,808,000	1932	31,683,000
1932-33	14,601,000	9,239,000	23,840,000	10,274,000	11,572,000	21,846,000	1933	23,095,000
1933-34	29,880,000	8,320,000	38,200,000	11,122,000	12,092,000	23,214,000	1934	27,141,000
1934-35 <sup>4</sup>	14,102,000	8,944,000	23,046,000	.....	.....	.....	.....	.....

<sup>1</sup> From 1923-24 figures represent receipts at interior warehouses, earlier figures receipts at ports of shipment.

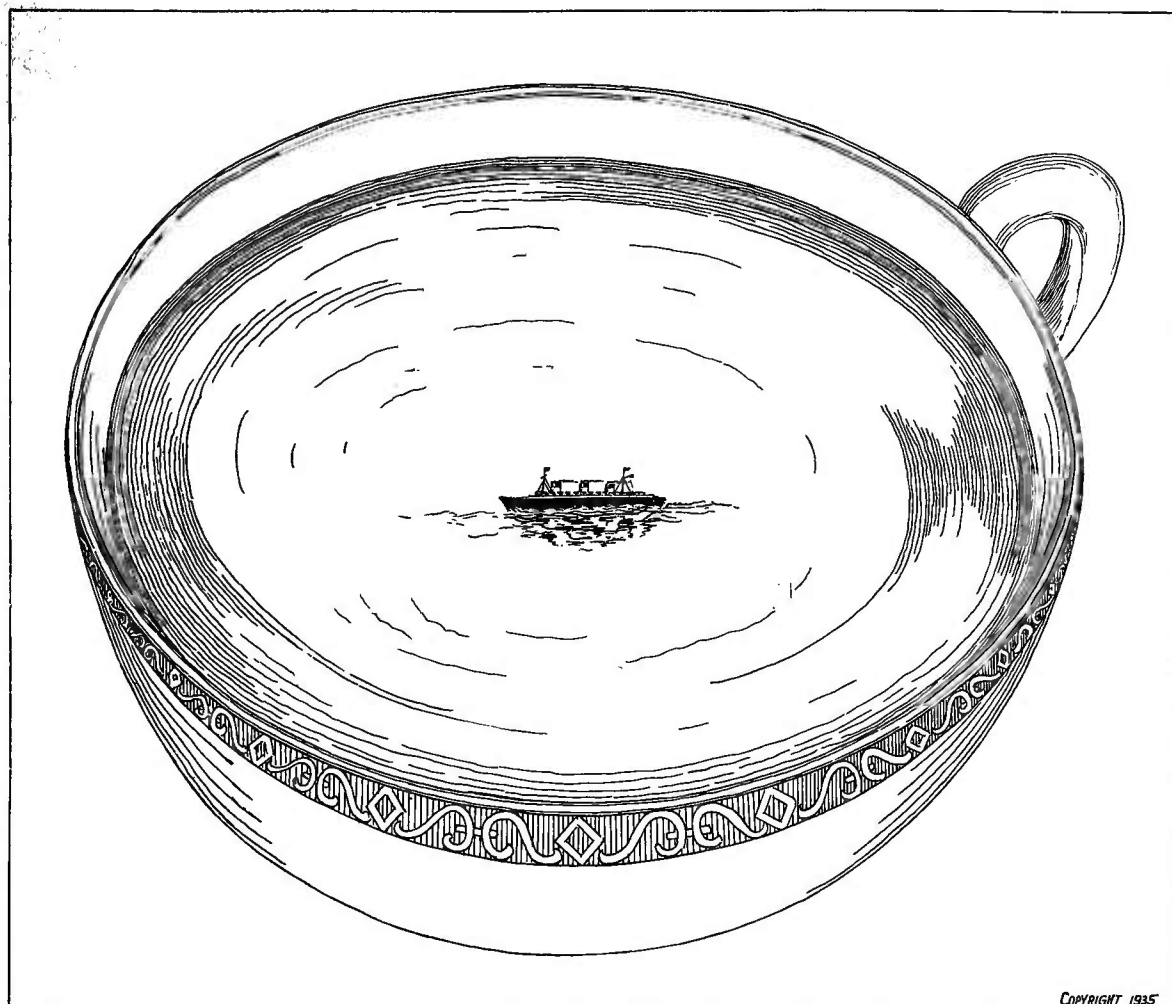
<sup>2</sup> Figures represent arrivals in consuming countries.

<sup>3</sup> Includes arrivals at non-statistical ports from 1919-20.

<sup>4</sup> From 1907-08 includes deliveries at "Southern ports." <sup>5</sup> Includes "interior stocks" in Brazil from 1924.

<sup>6</sup> Estimated.





COPYRIGHT 1935

#### THE WORLD'S COFFEE CUP AND THE WORLD'S LARGEST SHIP

The statistical sharks talk of the 29,000,000 bags, or 3,800,000,000 pounds, of coffee that the world drinks every year; but how many really appreciate what these figures mean? For instance, computing 40 cups of beverage to the pound, there are about 152,000,000,000 cups drunk annually, or enough to fill a gigantic cup 6,360 feet in diameter and 40 feet deep, on which the *Normandie*, the world's largest ship, would appear floating approximately as shown in the drawing.

ing industry has developed in most of these places, and in a few places of minor importance not named in the table.

**BRAZIL.** The coffee industry of Brazil, which has furnished seventy per cent of the world's coffee in the last ten years, has developed in a century and a half. Brazilian soil first made the acquaintance of the coffee plant in an unsuccessful planting at Para in 1723. The first successful commercial planting occurred in 1727. A small export trade to Europe had developed by 1770, the year when the first plantation was established in the state of Rio de Janeiro, and the time from which the country's great industry really dates. Apparently development was slow at first. There were occasional shipments to Portugal, and

possibly to other countries, but the formal recording of exports did not begin until the opening of the nineteenth century, so that the written history of Brazil's coffee trade may be considered as a matter entirely of the nineteenth and twentieth centuries.

Once started, however, the new line of export made rapid progress. In 1800 the amount of coffee exported was 1,720 pounds, contained in thirteen bags. Twenty years later 12,896,000 pounds were shipped, the number of bags being 97,498, of 60 kilos, or 132.27 pounds, each. Ten years later, in 1830, this amount had increased to 64,051,000 pounds, and in 1840 to 137,300,000 pounds. In 1852-53 the receipts for shipment at the ports were double that

EXPORTS OF COFFEE FROM THE COFFEE-PRODUCING  
COUNTRIES OF THE WORLD

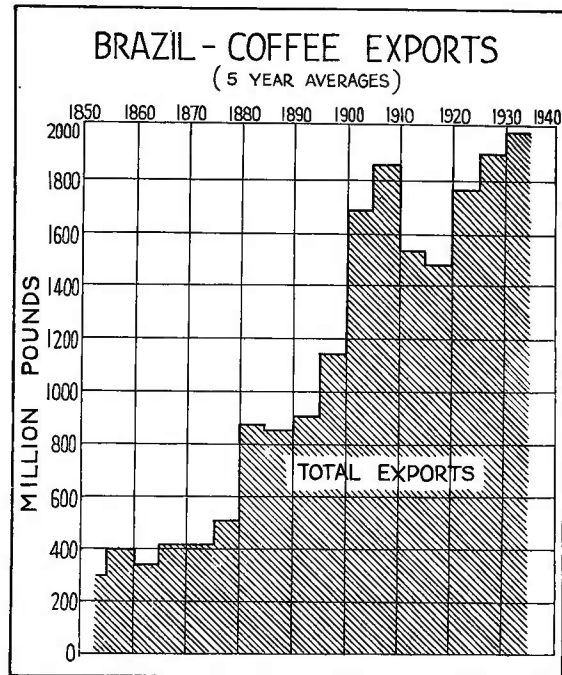
<i>Country</i>	<i>Year</i>	<i>Exports (pounds)</i>	<i>Five-Year Average (pounds)</i>
<b>South America:</b>			
Brazil .....	1934 <sup>1</sup>	1,871,309,000	1,975,688,000
Colombia .....	1934 <sup>1</sup>	415,728,000	419,629,000
Venezuela .....	1933	75,250,000	110,626,000
Guiana, Br. ....	1933	1,143,000	853,000
Guiana, D. ....	1933	5,862,000	6,237,000
Ecuador .....	1933	15,498,000	17,696,000
Peru .....	1933	4,104,000	3,469,000
<b>Central America:</b>			
Salvador .....	1934 <sup>1</sup>	109,935,000	114,182,000
Nicaragua .....	1933	30,212,000	29,201,000
Costa Rica .....	1934 <sup>2</sup>	42,026,000	49,335,000
Guatemala .....	1933	77,891,000 <sup>3</sup>	96,452,000 <sup>3</sup>
Honduras .....	1933 <sup>4</sup>	4,237,000	3,307,000
Mexico .....	1933	90,909,000	65,949,000
<b>West Indies:</b>			
Haiti .....	1934 <sup>5</sup>	75,018,000	70,369,000
Dominican Republic .....	1933	26,001,000	14,855,000
Cuba .....	1933	7,170,000	4,124,000
Jamaica .....	1934	7,034,000	8,358,000
Puerto Rico .....	1934	1,823,000 <sup>6</sup>	1,331,000 <sup>6</sup>
Martinique .....	1933	80,000	60,000
Guadeloupe .....	1933	647,000	608,000
Trinidad and Tobago .....	1933	339,000	682,000
Netherland East Indies .....	1934 <sup>1</sup>	180,409,000	174,700,000
<b>Pacific Islands:</b>			
New Caledonia .....	1933	2,216,000	2,111,000
New Hebrides .....	1933	970,000	565,000
Hawaii .....	1934	7,546,000 <sup>6</sup>	7,894,000 <sup>6</sup>
Reunion .....	1933	2,000	13,000
<b>Asia:</b>			
Aden .....	1934 <sup>7</sup>	9,887,000	9,613,000
British India .....	1934	18,863,000	22,686,000
French Indo-China .....	1933	619,000	556,000
<b>Africa:</b>			
Eritrea .....	1933	5,694,000	5,834,000
Somaliland, Br. ....	1932	836,000	418,000
Ethiopia .....	1933	27,589,000	35,178,000
Tanganyika .....	1933	28,488,000	24,073,000
Kenya and Uganda .....	1933	40,031,000	35,157,000
Nyasaland .....	1933	40,000	86,000
Madagascar .....	1933	33,627,000	22,229,000
Angola .....	1933	26,451,000	23,796,000
Belgian Congo .....	1933	18,704,000	8,449,000
French Equatorial Africa ..	1933	187,000	133,000
Ivory Coast .....	1933	3,743,000	2,029,000
Gold Coast .....	1933	79,000	28,000
French Guinea .....	1933	99,000	26,000
St. Thomas and Prince's Isl.	1933	1,657,000	1,243,000
Liberia .....	1932	3,439,000	2,735,000 <sup>6</sup>
Cape Verde Islands .....	1933	65,000	94,000

<sup>1</sup> Preliminary. <sup>2</sup> Crop year ending Sept. 30. <sup>3</sup> Includes coffee cleaned and in parchment. <sup>4</sup> Fiscal year ending June 30. <sup>5</sup> Fiscal year ending Sept. 30. <sup>6</sup> Includes exports to continental United States. <sup>7</sup> Fiscal year ending March 31. <sup>8</sup> Three-year average.

amount, 284,592,000 pounds; in 1860-61 they were 420,420,000 pounds; in 1870-71 they had increased to 427,416,000 pounds, and in 1880-81 to 764,945,000 pounds. In 1890-91 they were somewhat lower, amounting to 739,654,000 pounds. But at the turn of the century, in the year 1900-01, they had mounted to 1,504,424,000 pounds, having passed the one-billion-pound mark in 1896-97.

This great expansion in output led to a prohibition of new planting over a period of years. But the adoption of this measure in 1902 had no immediate effect on coffee output, as newly planted trees do not come into full bearing for five years. Production rose to a peak in 1906-07 with a total of 2,699,645,000 pounds, which continued to stand as an all-time high for twenty-one years. The earlier restrictions on planting then began to take effect, and production for two decades ranged for the most part between ten and fifteen million bags, or 1,300,000,000 and 2,000,000,000 pounds. And then, within the space of seven years, four immense crops, each one larger by far than any up to that period, poured great volumes of coffee into the warehouse and ports of Brazil. In 1927-28 a total of 25,945,000 bags, or 3,425,000,000 pounds, was recorded. Two years later this figure was raised to 29,404,000 bags, or 3,881,000,000 pounds. In 1931-32 the output was 26,103,000 bags, or 3,446,000,000 pounds, and then in 1933-34 came the highest production in the history of the Brazilian coffee industry, 29,880,000 bags, or almost four billion pounds. This one year's output of Brazil alone, with no contribution from other coffee-bearing areas, was enough to provide every inhabitant of the globe with some eighty cups of coffee.

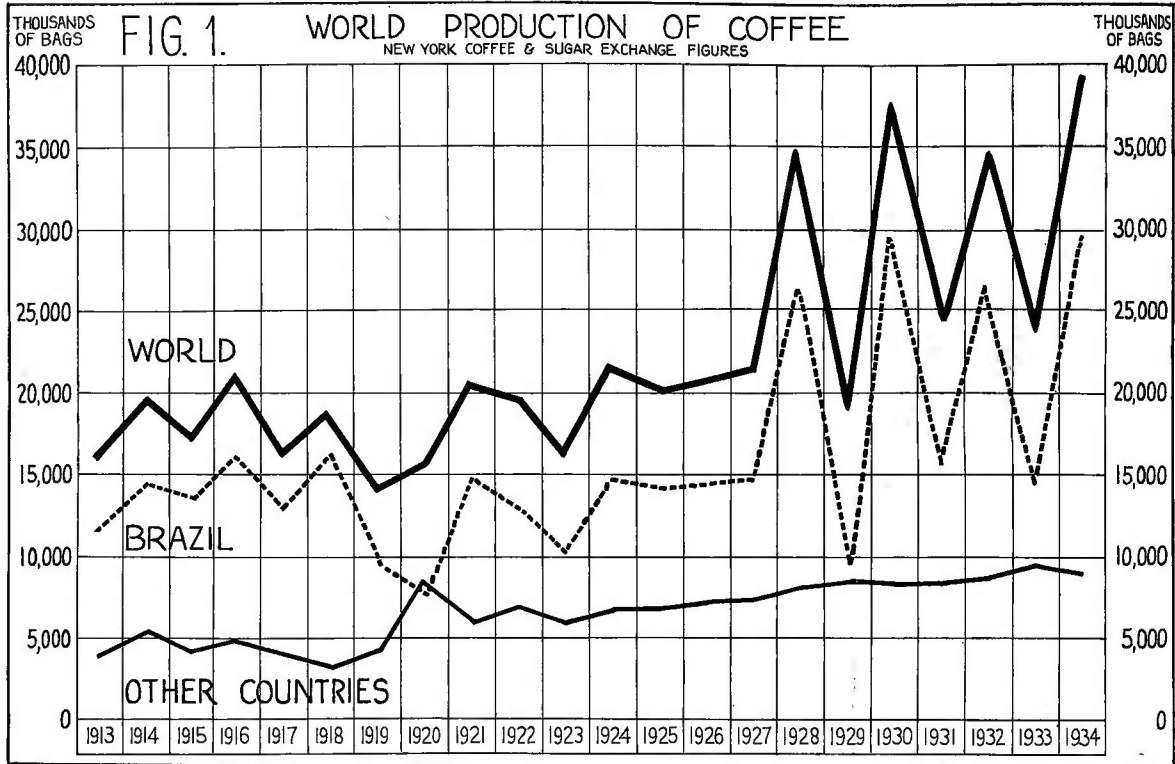
It has been estimated that the area in the coffee-growing section of Brazil suitable for coffee raising covers 1,158,000 square miles, or more than one-third the area of continental United States. The state of São Paulo is the chief producing state, and supplies one-third to one-half or more of the world's annual output. Most of this São Paulo coffee is exported through the port of Santos, which is consequently the leading coffee port of the world. Besides Santos, the ports of Rio de Janeiro and Victoria are of much importance in the coffee trade. Many millions of pounds are exported each year through the port



BRAZIL'S COFFEE EXPORTS, 1850-1934  
Graph based on five-year averages, with quantities given in millions of pounds.

of Bahia, and smaller amounts through various other ports. The crop year of Brazil runs from July 1 to June 30, the heaviest receipts for shipment coming as a rule in the months of August, September, and October of each year. Formerly, one-third of the season's crop was received at ports of shipment before the last of October, sometimes as early as the latter part of September; one-half by the middle or last of November; and two-thirds by the end of January. With the establishment of interior warehouses, however, it has been possible to provide for a more even flow of coffee to ports, and such control has been one of the chief benefits of the system of "coffee defense."

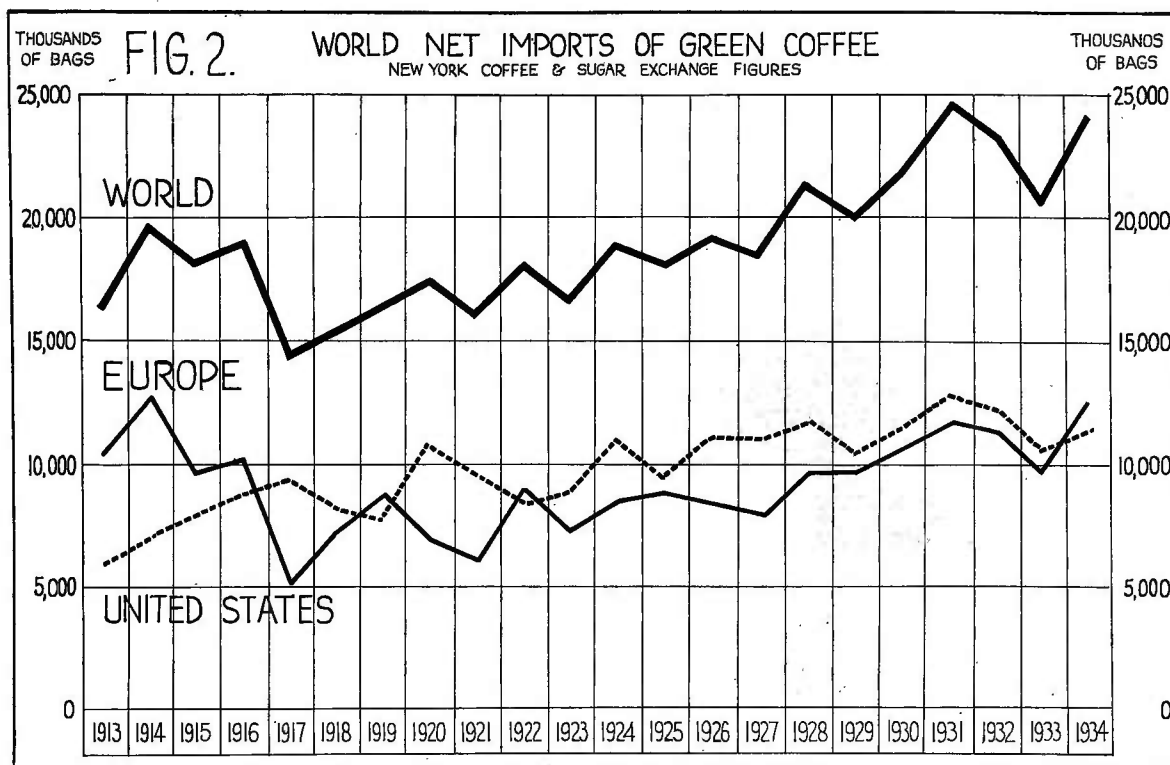
VENEZUELA. The coffee plant was introduced into Venezuela from Martinique in 1784, and the first shipment abroad, consisting of 233 bags, was made five years later. By 1830-31 production had increased to 25,454,000 pounds, and in the next twenty years it more than trebled, amounting to 83,717,000 pounds in 1850-51. Since then, however, the increase has been more gradual. In 1881-82, 94,369,000 pounds were produced, and about the same amount, 95,170,000 pounds, in 1889-90. Twentieth-century production has apparently exceeded the hundred-million mark, on the average; although there are no



definite statistics beyond export figures. These showed 86,950,000 pounds sent abroad in 1904-05; 103,453,000 pounds in 1908-09; and 88,155,000 pounds in 1918, the trade in the last-named year being cut down by war conditions. In 1919, the extraordinary amount of 179,415,000 pounds, the greatest yearly export in the country's history, was shipped abroad. The high figure was due to the release of coffee stored from previous years. Post-war exports have shown no tendency toward an increase. The annual average for the five years 1929-33 was 110,626,000 pounds as compared with a 1924-28 average of 105,954,000 pounds, and a 1919-23 average of 118,536,000 pounds. It has been estimated that domestic consumption of coffee would amount to a maximum of 25,000,000 pounds annually, but it may be much less than that. The United States and France have long been leading buyers of Venezuelan coffee but since the war Spain has figured prominently in the trade, and in most years has taken a larger share of the direct exports than France.

**COLOMBIA.** Prior to 1912, the total production of coffee in Colombia was around 80,000,000 pounds annually, of which some 3,000,000 or 4,000,000 pounds were consumed in the country itself. But since

that time production has been making phenomenal advances, and within a quarter of a century exports have increased more than five-fold. Colombia now supplies the world with about one-fifth as much coffee as Brazil. The industry has practically grown up in the last eighty years, the exports for the decade 1852-53 to 1861-62 averaging only 940,000 pounds; in the decade following, about 5,700,000 pounds; and in the ten years from 1872-73 to 1881-82, about 12,600,000 pounds, according to an unofficial compilation. Exportations advanced to about 47,000,000 pounds by 1895, and to 80,000,000 pounds by 1906, at which general level they remained for the next six years. In 1912 they jumped to 122,654,000 pounds, and from that time on the advance was rapid and fairly consistent from year to year. During the war years they averaged about 147,000,000 pounds, in 1919-23 about 246,000,000 pounds, and in 1924-28 about 308,000,000 pounds. This rapid growth has continued up to the present and indeed has even been accelerated in recent years. The five-year average in 1929-33 was 410,411,000 pounds. In 1932, the record figure for exports up to that time was achieved, with shipments of 421,376,000 pounds, but this mark was



passed in 1933, when 434,589,000 pounds were supplied to the markets of the world. The trade since the war is shown in the following table:

COLOMBIAN COFFEE EXPORTS

Year	Pounds
1919-23 (average)	245,973,000
1924	293,101,000
1925	257,506,000
1926	324,644,000
1927	311,711,000
1928	351,799,000
1929	375,106,000
1930	419,714,000
1931	401,269,000
1932	421,376,000
1933	434,589,000
1934 (preliminary)	415,728,000

**ECUADOR.** Annual production in Ecuador has been steadily on the up-grade for a quarter of a century. Formerly the great bulk of the exports went to Chile, but since the war Spain and France have been the largest buyers. Only a comparatively small amount now comes to the United States.

Planters in Ecuador began to give some attention to coffee cultivation about the middle of the last century, but for a long while sales showed only a gradual

increase. Exports were 87,000 pounds in 1855, 296,000 pounds in 1870, and 985,000 pounds in 1877. By the beginning of the present century, production had reached 6,204,000 pounds; in 1905 it was estimated at 4,861,000 pounds; and in 1910 at 8,682,000 pounds. Exports in 1912 were 6,102,000 pounds and in 1918 7,671,000 pounds. The increase during and since the war is shown by annual average export figures for various periods: 1914-18, 6,476,000 pounds; 1919-23, 8,425,000 pounds; 1924-28, 13,669,000 pounds; and 1928-32, 18,641,000 pounds.

**PERU.** Coffee is one of the minor products of Peru, and the country does not occupy a place of importance in the international coffee trade. The larger part of the production is apparently consumed in the country itself. In recent years, however, the export trade has shown a very marked revival after a decline in the post-war years which almost wiped it out. In 1905, exports amounted to 2,267,000 pounds. They fell to 1,618,000 pounds in 1908, and to an average of 529,000 pounds in the five years ending with 1918. For the next five years the average was still lower, 162,000 pounds, the lowest point being reached in 1923 with a trade of only 13,000 pounds. From that time on, how-



ever, exports have grown rapidly, the 1924-28 average being 1,138,000 pounds and that of 1929-33 being 3,469,000 pounds. The highest point in the revived trade was reached in 1932, with exports of 5,337,000 pounds. Production is mainly in the coast lands.

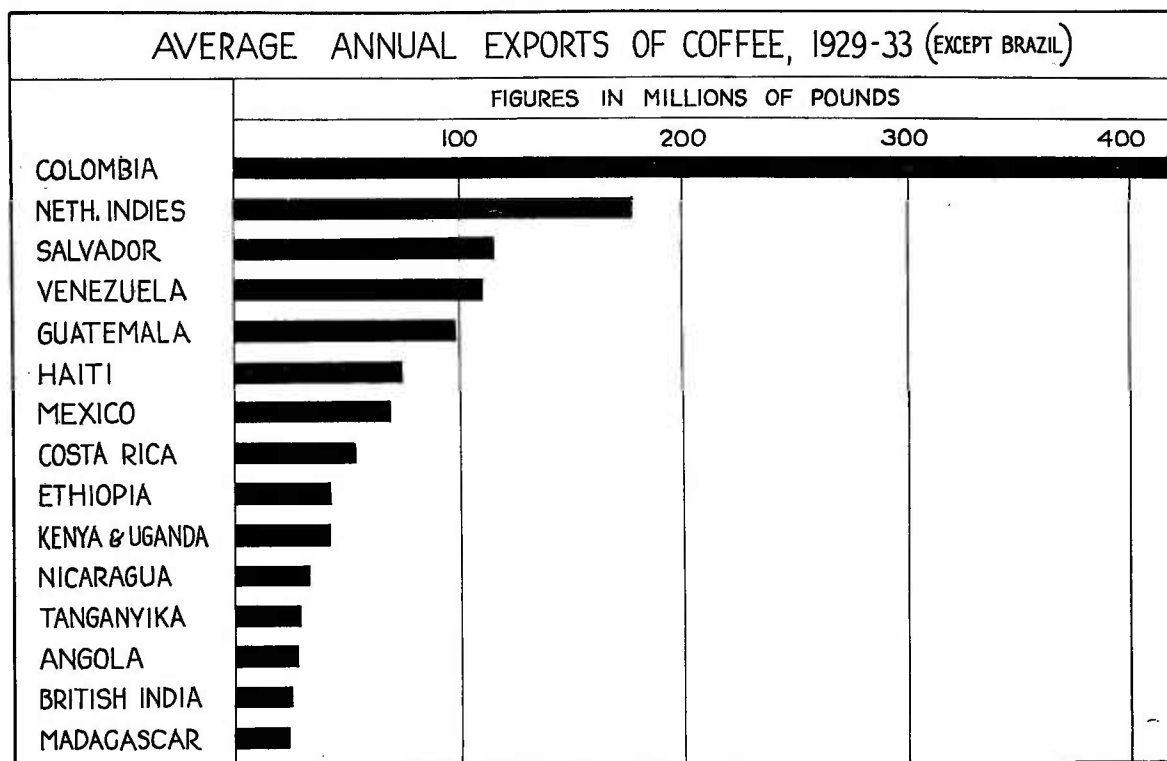
**BRITISH GUIANA.** The Guianas are said to be the site of the first coffee planting on the continent of South America, and according to some accounts the first in the New World. The plants were brought first into Dutch Guiana, but there was no planting in what is now British Guiana (then a Dutch colony) until 1752. Twenty-six years later 6,041,000 pounds were sent to Amsterdam from the two ports of Demarara and Berbice, and after the colony fell into the hands of the English in 1796, cultivation continued to increase. Exports amounted to 10,845,000 pounds in 1803, and to more than 22,000,000 pounds in 1810. Then there was a falling off, and the production in 1828 was 8,893,500 pounds and 3,308,000 pounds in 1836. In 1849 British Guiana exported only 109,600 pounds. For a long period thereafter there was little production and practically no exportation. Exports in 1907, for instance, amounted to only 160 pounds. Then they began to increase rapidly and soon reached several hundred thousand pounds. Since 1914, their lowest mark was 172,000 pounds, in 1915, and in most years the total was several times that figure. In a number of scattered years the trade approached one million pounds but it never quite reached that level until 1932, when exports of 1,054,000 pounds were recorded. The 1928-32 average of 809,000 pounds compares with 661,000 pounds in 1924-28, 618,000 pounds in 1919-23, and 342,000 pounds in 1914-18. In 1931 the area in coffee plantations cultivated by Europeans was stated to be 4,657 acres.

**FRENCH GUIANA.** The colony raises a small amount of coffee for local consumption, and in some years exports a few hundred pounds, but it is really an importing and not an exporting colony. Coffee cultivation was never of much importance, although in 1775 some 72,000 pounds were exported. In 1860, 180,000 pounds were harvested, and in 1870, 132,000 pounds, mostly for local consumption. In late years exports have been negligible.

**DUTCH GUIANA.** Regular shipments of coffee from Dutch Guiana have been made

for two centuries, beginning—a few years after the plant was introduced—with a shipment of 6,461 pounds to the mother country in 1723. Seven years later, 472,000 pounds were shipped, and in 1732-33 exportation reached 1,232,000 pounds. By 1760, exports were averaging 16,900,000 pounds a year, and they reached almost 20,600,000 pounds in 1777. At the beginning of the nineteenth century they amounted to about 17,000,000 pounds, but a few years later they fell off to some 7,000,000 pounds, where they remained until about 1840, after which they began to decline. Exportation had practically ceased by 1875, only 1420 pounds being shipped, although cultivation still continued, as evidenced by a production of 82,357 pounds in that year. In 1890, production was only 15,736 pounds and exports only 476 pounds. Then came a revival, and by 1900 production had reached 433,000 pounds and exports 424,000 pounds. Eight years later the output was 1,108,000 pounds and shipments abroad 310,000 pounds; and in 1909 the figures were 552,000 pounds produced and 405,000 pounds exported. Over the next twenty years expansion was very marked, as indicated by the growth of exports. For the five-year period 1909-13 they averaged 388,000 pounds. In 1914-18 the average grew to 1,064,000 pounds, in 1919-23 to 4,957,000 pounds, and in 1924-28 to 5,271,000 pounds. For the five years 1928-32 the export average was still higher, 6,588,000 pounds, with 7,169,000 pounds recorded for 1932. The great bulk of the crop is exported, as is shown by the fact the production in 1932-33 was 8,495,000 pounds. The area planted to coffee in that year was stated as 21,662 acres.

**OTHER SOUTH AMERICAN COUNTRIES.** Of the other South American countries, Argentina, Chile, and Uruguay are coffee-importing countries, and the coffee-raising industry of Paraguay, although it has shown some promise in the past, is yet to be developed. In Argentina a few hundred acres in the sub-tropical provinces to the north have been planted in coffee, but coffee-growing is likely to remain a minor industry. Many attempts have been made to establish the industry in Paraguay, where favorable conditions obtain, but only a few planters have met with success. Their product has all been consumed locally. Bolivia has much land suitable



for coffee raising, and coffee has been one of the leading agricultural products of the country for a long while. The quality is excellent, but there has been little systematic cultivation and grading as in the neighboring country of Brazil. Quantity of production is a matter of estimate, but it probably runs into many millions of pounds annually. It has been nearly all consumed within the country itself, but within the last two or three years considerable exports have been recorded. In 1931, these shipments totaled 63,000 pounds and in 1932, 1,222,000 pounds. The coffee is grown in the country east of the Andes, and lack of transportation has been a big obstacle to the development of the industry.

**SALVADOR.** Coffee was introduced into Salvador in 1852, and immediately began to spread over the country. Exports were valued at more than \$100,000 in 1865. By 1874-75 the amount exported had reached 8,500,000 pounds. The first large plantation was established in 1876, and since then planting has continued until now practically all the available coffee land has been taken up. The area in plantations has been estimated at as high as 230,000 acres, with annual yields up to 165,000,000 pounds. Since the beginning of the present century exports have shown a

steady gain, having nearly doubled in the last twenty years. In 1901, exports were 50,101,000 pounds; in 1905, 64,480,000 pounds; in 1910, 62,764,000 pounds; in the five years 1909-13, an average of 63,086,000 pounds; and in later five-year periods an average annual total as follows: 1914-18, 76,363,000 pounds; 1919-23, 81,141,000 pounds; 1924-28, 97,360,000 pounds; and 1929-33, 112,823,000 pounds.

**GUATEMALA.** Cultivation of coffee in Guatemala became of importance between 1860 and 1870. In 1860 exports were only about 140,000 pounds; by 1863 they had increased to about 1,800,000 pounds; and by 1870 to 7,590,000 pounds. In 1880-81 they amounted to 28,976,000 pounds, and in 1883-84 to 40,406,000 pounds. Twenty years later they had doubled, and during the period immediately preceding the war they ranged as a rule between 70,000,000 and 100,000,000 pounds. For a quarter-century or more they have been stabilized at about that level. In pre-war years exports included a large percentage of coffee shipped "in the shell," the amount being about 20,000,000 pounds annually. In more recent years this trade has dropped to some 3,000,000 pounds. Exports of Guatemalan coffee for the years 1924-1933 are shown in the following table:

## GUATEMALA'S COFFEE EXPORTS

Year	Cleaned (pounds)	Unshelled (pounds)
1924	88,891,000	964,000
1925	97,067,000	920,000
1926	93,162,000	1,248,000
1927	112,991,000	3,548,000
1928	94,621,000	3,624,000
1929	94,686,000	2,899,000
1930	122,599,000	3,335,000
1931	77,980,000	2,194,000
1932	97,580,000	3,098,000
1933	76,600,000	1,290,000

**COSTA RICA.** Coffee raising in Costa Rica dates from 1779, when the plant was introduced from Cuba. By 1845 the industry had grown sufficiently to permit an exportation of 7,823,000 pounds, and twenty years later 11,143,000 pounds were shipped. Thereafter production increased rapidly, so that in 1874 the total exports were 32,670,000 pounds and in 1884 more than 36,000,000 pounds. For the next thirty years or more exports ranged as a rule between 25,000,000 and 35,000,000 pounds. But after the World War there was a gradual increase, and in the decade 1920-21 to 1929-30 exports averaged 38,153,000 pounds annually. The upward tendency has been especially marked in the last half-dozen years, as is shown by the accompanying table of exports.

## COSTA RICA COFFEE EXPORTS

Crop year	Pounds
1928-29	43,378,000
1929-30	51,889,000
1930-31	50,738,000
1931-32	40,783,000
1932-33	61,239,000
1933-34	42,026,000

In addition to the amount exported in 1933-34 it is stated unofficially that 2,800,000 pounds were retained for home consumption. Estimates of the 1934-35 yield place the probable total at 50,000,000 to 53,000,000 pounds.

**NICARAGUA.** Production of coffee in Nicaragua began between 1860 and 1870, and in 1875 the yield was estimated at 1,650,000 pounds. By 1879-80 this had increased to 3,579,000 pounds and by 1889-90 to 8,533,000 pounds. In 1890-91 production was 11,540,000 pounds, and in 1907-08 it was estimated at more than 20,000,000 pounds. Ten years later 25,-

000,000 pounds were produced. In the post-war period production in general has been heavier and the average annual exports in the years 1924-33 were 30,970,000 pounds, despite an abnormally low trade in 1932. Lack of transportation and excess of political troubles have been important factors in holding back development.

**HONDURAS.** The coffee of Honduras is of very good quality but development in the past has been held back by lack of transportation facilities and until the post-war period the country did not have any particular prominence in international trade. Exports formerly ran less than a million pounds a year, but since the war they have reached much larger totals. For many years they have averaged well above 3,000,000 pounds, and in the fiscal year 1933 they passed 4,000,000 pounds.

**BRITISH HONDURAS.** This colony grows a little coffee for its own use, but imports most of what it needs. Production had reached almost 50,000 pounds in 1904, but at present such coffee as is gathered comes only from a few scattering trees, and commercial interest lies only in the possibility of future development.

**PANAMA.** A small amount of coffee, of which as much as 200,000 or 250,000 pounds a year have been occasionally exported, is raised in the uplands of Panama or is gathered from wild trees. The industry is not of great importance but is sufficient to supply the greater part of domestic needs and imports are normally small.

**MEXICO.** A very good grade of coffee is produced in Mexico, and there is said to be sufficient area of good coffee land to supply the demands of the world outside of that furnished by Brazil. But production is limited and to a considerable extent the crop goes to satisfy home needs. In spite of much government encouragement in past years, coffee cultivation can not be said to have made rapid progress when we remember that the country became acquainted with the plant as early as 1800. Not until about 1870 did Mexico begin to become important as a coffee exporter, but by 1878-79 shipments amounted to about 12,000,000 pounds a year. This increased to 29,400,000 pounds in 1891-92, and thereafter for the next thirty years, although fluctuating greatly at times from one year to another, production mounted gradually upward.

At the beginning of the century the annual output was averaging about 56,000,000 pounds. In 1918, despite the long preceding period of revolutionary troubles, production was no less than 105,000,000 pounds. But this was an exceptional yield. In the crop years 1921-22 to 1925-26 coffee production averaged 76,580,000 pounds annually and in the years 1926-27 to 1930-31, 89,083,000 pounds. The greater part of the annual yield goes into export trade. Next to the United States, Germany has been traditionally Mexico's best coffee customer.

**HAITI.** For well over a century Haiti has been shipping tens of millions of pounds of coffee annually, the product being the mainstay of the country's economic life. In all that time, however, shipments have maintained much the same annual level. Haiti has been a coffee producer from the early years of the eighteenth century, when the plants began to spread from the original sprigs in Guiana or Martinique. After half a century of growth exports had risen to 88,360,000 pounds in 1789-90, a mark that was not reached again for 129 years. Since 1790, exports as a rule have ranged between 40,000,000 and 80,000,000 pounds. They were 38,000,000 pounds in 1856; 55,750,000 pounds in 1866; and 52,300,000 pounds in 1876. They reached 84,028,000 pounds in 1887-88 but fell back to 67,437,000 pounds in 1897-98, and ten years later they were only 63,848,000 pounds. In 1917-18 war conditions brought the total down to 42,100,000 pounds.

From 1916-17 to 1931-32 exports averaged 67,386,000 pounds annually, although this period included the record exportation of 107,781,000 pounds in 1918-19, when large stocks which had been held up by the war were released. In the fiscal year 1932-33 (October 1 to September 30) the island produced the greatest yield of coffee in its history, and the exports reached 92,033,000 pounds. In the fiscal year 1933-34, exports were 75,018,000 pounds. However, in the October-December quarter of 1934, exports were far below normal and indications were that the total for the year 1934-35 would be lower than for any other year since the war. The average yearly coffee crop is estimated at 32,000,000 kilos, or 70,547,000 pounds, of which some 8,000,000 pounds are said to be consumed in the island itself. Production is on small

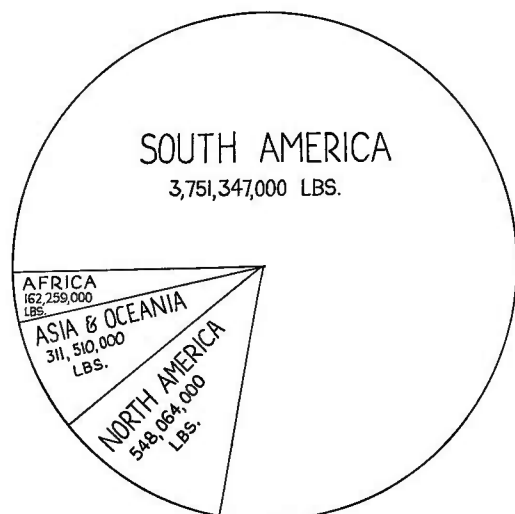
plots of ground instead of plantations. Exports go almost wholly to western Europe, France taking the bulk of the crop each year.

**DOMINICAN REPUBLIC.** Within the last ten years coffee production has advanced rapidly and exports are now two to three times as heavy as in the years during and immediately following the war. The quality of the coffee is good, but in the past plantations have received inadequate care. Until fifty years ago the industry was in a state of decline from a condition of former importance, but it was revived, and by 1881 it supplied 1,400,000 pounds of coffee for export. The amount was 1,480,000 pounds in 1888, 3,950,000 pounds in 1900, 1,540,000 pounds in 1909, and 4,870,000 pounds in 1919. Beginning about 1926 exports reached a new level, shipments in that year being 9,496,000 pounds. In the five years 1929-33 exports averaged 14,855,000 pounds and in 1933 they amounted to 26,001,000 pounds. Only a small portion of the available coffee land is yet in cultivation. Europe takes most of the export.

**JAMAICA.** Jamaica began to raise coffee about 1730, and from that time on there was a steady but slow increase in production. Shipments amounted to about 60,000 pounds in 1752, and to about 1,800,000 pounds in 1775. At the beginning of the new century, in 1804, exports of 22,000,000 pounds were recorded. In 1814, the figure was 34,045,000 pounds. Then exports gradually fell off and in 1861 were only 6,700,000 pounds. They were 10,300,000 pounds in 1874, and from that time until the World War did not vary greatly, standing at 8,000,000 to 10,000,000 pounds a year. They were 9,363,000 pounds in 1900; 7,885,000 pounds in 1909; and 8,246,000 pounds in 1919. Following the war exports declined, but in 1931 they approached pre-war figures with a total of 9,177,000 pounds. This was followed in 1931 and 1932 by aggregate shipments of 8,877,000 and 9,824,000 pounds, respectively. The acreage in coffee remained fairly constant until about six years ago, being 24,865 in 1900, 22,275 in 1911, 20,280 in 1917, and 17,922 in 1929. In 1930, the official returns show an acreage of 6,231 and the area in coffee has remained near that figure in succeeding years. This large decrease, however, appears to have been due to a change in the method of

classification rather than an actual reduction in coffee area, as total production at this time showed a considerable increase. It is said there are 80,000 acres of good coffee land still uncultivated.

**PUERTO RICO.** The cultivation of coffee in Puerto Rico dates back to the middle of the eighteenth century, but exportation does not seem to have been much more than a million pounds a year until the first



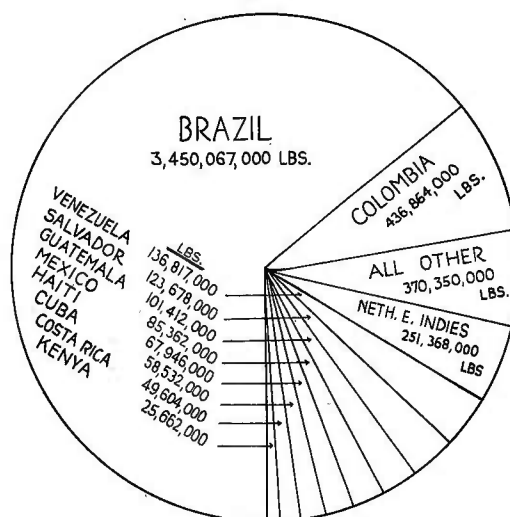
AVERAGE ANNUAL PRODUCTION OF COFFEE  
BY CONTINENTS  
Five years, 1928-29 to 1932-33.

years of the nineteenth century. Between 1837 and 1840 the average exportation was about 10,000,000 pounds, and by 1865 this had risen to 24,000,000 pounds. Ten years later it was 25,700,000 pounds. In the years preceding the war it averaged some 37,000,000 pounds annually, and the 1921 figure, including shipments to continental United States, was about 30,000,000 pounds.

Until 1928, production for half a century ranged between 30,000,000 and 50,000,000 pounds, the heaviest being in 1896, when the total output was 62,628,000 pounds. The industry has suffered severely at times from hurricanes. In 1926 a storm damaged 40 per cent of the crop and cut down exports by one-fourth. But the greatest disaster came in 1928, when a storm swept 40,000,000 to 50,000,000 pounds of coffee from the trees and wiped out the greater part of the plantations. In 1929 only some 5,000,000 pounds were gathered. As the normal consumption in the island itself is about 12,000,000 pounds considerable imports have been necessary

since 1928. Exports, however, have continued on a small scale, averaging little more than 1,000,000 pounds in the years 1929-33. The plantations are being rehabilitated, but production will not reach normal for some years to come. Puerto Rican coffee has not been popular in the United States and only a comparatively insignificant amount is marketed each year on the mainland. Normally most of the crop has gone to Cuba and Europe.

**GUADELOUPE.** Coffee production in Guadeloupe reached its highest point in the latter part of the eighteenth century, when more than 8,000,000 pounds a year were raised. The figure was about 6,000,000 in 1808, but the output declined during the succeeding decades and forty years later it was only 375,000 pounds. In 1885, the amount produced was 986,000



AVERAGE ANNUAL PRODUCTION OF COFFEE  
BY COUNTRIES  
Five crop-years, 1928-29 to 1932-33.

pounds. There was then a gradual increase, and the yield became large enough to permit the exportation of 1,000,000 to 2,000,000 pounds or more annually from about the beginning of the present century. Exports in 1901 were 1,449,000 pounds; in 1908, they were 2,266,000 pounds; in 1918, they were 2,144,000 pounds; and in 1928, they were 1,022,000 pounds. Within the last few years a series of short crops has brought the average exportation well below one million pounds a year.

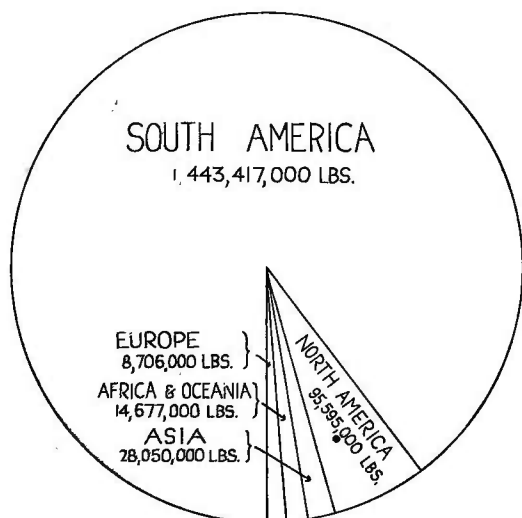
**CUBA.** Cuba was formerly one of the important centers of coffee production, but for many reasons the industry declined and



the country came to depend on coffee imports for a large part of its needs. A century ago, the plantations numbered 2,067 and the annual exportation amounted to 50,000,000 pounds. When the island became independent steps were taken to revive coffee planting, and in 1907 there were 1,411 plantations and 3,662,850 trees, producing 6,596,000 pounds of coffee. But the growing sugar industry drew the attention of planters away from coffee, and the island came to import regularly some 20,000,000 pounds or more a year from Puerto Rico and other sources. The high prices for sugar after the war still further displaced coffee trees with sugar cane.

In more recent years, however, coffee raising has again become a flourishing industry, especially since sugar prices have declined. In 1925, the Cuban yield is stated to have been about 43,000,000

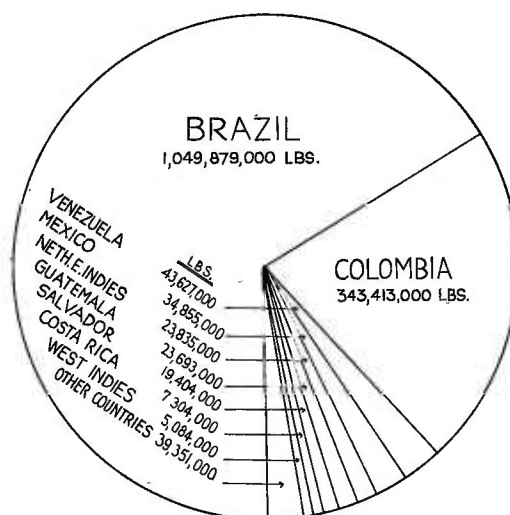
holdings. In the crop year 1931-32, according to an unofficial authority, the coffee area in the Province was 113,000 acres. Official figures of production for the Province in late years have been as follows: crop year 1928-29, 52,304,000 pounds; 1929-30, 58,768,000 pounds; 1930-31, 60,438,000 pounds; 1931-32, 52,693,000 pounds; 1932-33, 45,545,000 pounds. Estimates of production in the whole island in recent years are 50,000,000 to 70,000,000 pounds a year.



AVERAGE ANNUAL IMPORTS OF COFFEE INTO THE UNITED STATES BY CONTINENTS, 1930-34  
Total average pounds, 1,590,445,000.

pounds, some 60 per cent of the needed supply for the year. In 1930 an increase in the import duty on coffee greatly stimulated planting. Since 1931 the island has been almost independent of foreign sources of supply, and in 1932 and 1933 it produced enough over domestic needs to export 13,424,000 and 7,170,000 pounds, respectively, while imports, which were 12,184,000 pounds in 1930, were only 124,000 pounds in 1933.

Production is largely in the Province of Oriente, where there are about 730 plantations, besides several thousand small



AVERAGE ANNUAL IMPORTS OF COFFEE INTO THE UNITED STATES BY COUNTRIES, 1930-34  
Total average pounds, 1,590,445,000.

OTHER WEST INDIAN ISLANDS. Some little coffee is gathered for home consumption in many other West Indian islands, but little is exported. The island of Martinique, which is said to have seen the introduction of the coffee plant into the Western Hemisphere, does not raise enough for its own use. In Trinidad and Tobago exports have reached as high as 1,000,000 pounds a year, but in recent times have fallen off heavily. St. Vincent, Grenada, and the Leeward Islands, which have exported small shipments at times, have been listed for many years in the import column, although the trade is inconsiderable.

ARABIA. The home of the famous Mocha coffee still produces considerable quantities of that variety, although the output, comparatively speaking, is not large. The chief district is the vilayet of Yemen, and the product reaches the outside world mainly through the ports of Aden and Hodeida. The port of Massowah also draws some of the supply of Mocha for export. No sta-

## ADEN'S COFFEE RECEIPTS FOR RE-EXPORT

	1931-32	1932-33	1933-34
<i>Imports from—</i>	(pounds)	(pounds)	(pounds)
British Somaliland .....	613,000	1,000,000	828,000
Egypt .....	2,444,000	.....	.....
Kenya Colony .....	.....	2,853,000	3,286,000
Arabian ports:			
Hodeida .....	1,008,000	801,000	1,362,000
Mocha .....	1,877,000	2,115,000	1,809,000
Ethiopia (via Jibuti) .....	3,712,000	4,448,000	2,140,000
All other .....	280,000	445,000	243,000
<b>Total</b> .....	<b>9,934,000</b>	<b>11,662,000</b>	<b>9,668,000</b>

tistics are available to show accurately the production of Mocha coffee; but an estimate made before the war by the oldest coffee merchant in Aden placed the average annual output at 45,000 bags of 176 pounds each, or 7,920,000 pounds, and that figure probably would still do as well as another.

Although this is the only district in the world that can produce the particular grade of coffee known as Mocha, there is no particular advance in systematic cultivation, and large areas of good coffee land are planted to other crops to provide food for the natives. If transportation facilities should be provided so that food for the natives could be imported, it is stated that the output of Mocha coffee could be doubled.

Aden is a great transshipping port for coffee from Asia and Africa; the bulk of its exports being re-exports from points outside Arabia. The accompanying table shows the proportion of Arabian coffee coming into Aden for export as compared with that from other producing sections in this region.

**BRITISH INDIA.** Cultivation of coffee was begun systematically in India in 1840, and twenty years later the country exported about 5,860,000 pounds. For the next eight years the exports remained at about that figure; but in 1859 they amounted to 11,690,000 pounds, and by 1864 they had doubled, rising in that year to 26,745,000 pounds. They reached their highest point in 1872 with 56,817,000 pounds. In recent years production and exportation have greatly declined, exports in 1933 being only 19,467,000 pounds. The area under coffee ranged between 200,000 and 300,000 acres for fifty years or more, reaching its highest point in 1896, with 303,944

acres. Recently the area has been slowly decreasing and it is now about 160,000 acres.

**CEYLON.** The island of Ceylon was formerly one of the important producers of coffee, and the industry was a flourishing one until about 1869, when a leaf disease appeared which, in ten or fifteen years, practically ruined the plantations. The small production which remained has steadily declined, and is now insignificant. Today, Ceylon is ranked as an importer instead of an exporter of coffee. In 1933, it purchased over 3,000,000 pounds, chiefly from Java.

It is said that systematic cultivation was carried on in Ceylon by the Dutch as early as 1690. Shipments of 10,000 to 90,000 pounds a year were made all through the eighteenth century, exports in one year, 1741, going as high as 370,000 pounds. The English took the island in 1795, and thirty years later they began to expand cultivation. Exports had risen to 12,400,000 pounds in 1836, and they continued to increase to a high point of 118,160,000 pounds in 1870. But in the next thirty years they declined until they were only 1,147,000 pounds in 1900. The total acreage in coffee at one time reached as high as 340,000; but as the coffee trees were affected by the leaf disease this land was turned to tea, and only a few scattered acres are now left in coffee.

**NETHERLANDS INDIES.** The year 1699 saw the importation from the Malabar coast of India to Java of the coffee plants which were the progenitors of the tens of millions of trees that have made the Netherlands Indies famous for two hundred years. Twelve years afterward the first trickle of the stream of coffee that has continued to flow ever since found its way

from Java to the Netherlands in the form of a shipment of 894 pounds. About 216,000 pounds were exported in 1721, and soon thereafter shipments rose into the millions of pounds annually.

From 1721 to 1730, the Netherlands East India Company marketed 25,048,000 pounds of Java coffee in the Netherlands, and in the following decade 36,845,000 pounds. Shipments from Java continued at about the latter rate until the close of the century, although in the ten years 1771-80 they reached a total of 51,319,000 pounds. The total sales of Java coffee in the Netherlands for the century were somewhat more than a quarter of a billion pounds, which represented rather closely the amount produced.

With the beginning of the nineteenth century coffee production became much heavier and in 1825 Java exported, of its own production, some 36,500,000 pounds, besides 1,360,000 pounds brought from neighboring islands to which the cultivation had spread. In 1855, the amount was 168,100,000 pounds of Java coffee and 4,080,000 pounds of coffee from the other islands. This is the highest record for the half-century following the beginning of regular reports of exports in 1825. From 1875 to 1879 the average annual yield was 152,184,000 pounds. In 1900, production in Java was 84,184,000 pounds, in 1910 it was 31,552,000 pounds, in 1915 it was 73,984,000 pounds, and in 1932 it climbed to 113,402,000 pounds.

On the west coast of Sumatra coffee was regularly cultivated, according to one account, as early as 1783, but it was not until about 1800 that exportation began, shipments in that year amounting to 270,000 pounds. By 1840, exports were averaging 11,000,000 to 12,250,000 pounds a year. Official records of production date from 1852, in which year the figures were 16,714,000 pounds. Five years later, the recorded yield was 25,960,000 pounds, the high-water mark of Sumatra production. The total output in 1860 was 21,400,000 pounds and in 1870, 22,275,000 pounds. The average from 1875 to 1879 was 17,408,000 pounds and from 1895 to 1899 it was 7,589,000 pounds. The yield was 5,576,000 pounds in 1900, 1,360,000 pounds in 1910, and 7,752,000 pounds in 1915.

In Celebes the first plants were set out about 1750, but seventy years later production was only some 10,000 pounds. This

soon increased to half a million pounds, and from 1835 to 1852 the yield ran between 340,000 and 1,768,000 pounds. From 1875 to 1879 production averaged 2,176,000 pounds, from 1885 to 1889, 2,747,000 pounds, and from 1895 to 1899, 707,000 pounds. In 1900 it was 680,000 pounds, in 1910, 272,000 pounds, and in 1915, 272,000 pounds.

Production figures as now published divide the islands into two sections, one including Java and Madura and the other the "outer possessions" (Sumatra, Palembang, Celebes, Timor; Bali, etc.). Coffee grown on estates is also distinguished from that grown on native plantations. In 1933, the total area planted to coffee on estates in the Netherlands Indies was 308,224 acres, of which 239,140 acres was in Java and 69,084 acres in the outer possessions. Native plantations in Java covered 45,520 acres but the acreage in the outer possessions was unknown.

The total Netherlands Indies production for 1933 was officially placed at 234,666,000 pounds. This included 125,005,000 pounds of estate coffee and 109,661,000 pounds of native coffee—the latter figure representing exports only. Estates in Java produced 103,724,000 pounds and those in the outer possessions 21,281,000 pounds.

Robusta coffee makes up the greater part of the output, followed by Java Arabica and Liberica coffees. Production of these grades in 1933 was as shown in the accompanying table.

COFFEE PRODUCTION IN NETHERLANDS INDIES

Grade	Estates Production (pounds)	Calculated	Total (pounds)
		Native Production (pounds)	
Robusta . . . .	119,324,000	98,552,000	217,876,000
Java Arabica . . . .	3,415,000	11,045,000	14,460,000
Liberica . . . .	807,000	55,000	862,000
Other, incl. unshelled	1,459,000	9,000	1,468,000
Total . .	125,005,000	109,661,000	234,666,000

Planting under government control, largely with forced labor, at one time was a special feature of coffee cultivation in the Netherlands Indies. At first the government exercised what was practically a monopoly; but allowed more and more private planting, until, in the latter part of the nineteenth century, the amount of coffee produced on private plantations exceeded that raised by the government. The

government has long since given up the business of coffee production.

**BRITISH MALAYA.** As used herewith the term "British Malaya" includes the British Colony of the Straits Settlements, the Federated Malay States (Perak, Selangor, Negri Sembilan, and Pahang) and five independent Malay states.

Forty years ago coffee was the principal plantation crop of Malaya. It was displaced by rubber in the early years of the present century. Its commercial history goes back to the introduction of Liberian coffee about 1875, when coffee estates began to be set up in Selangor, Perak, and Negri Sembilan. In 1894, coffee exports from the first two of these states were about 530,000 pounds, and three years later they were 2,130,000 pounds. Exports reached their peak in 1905, when the three states shipped 14,296,000 pounds. Most of this came from Selangor. Thereafter the interest of planters shifted rapidly to rubber and the area in coffee declined.

In 1910 the total coffee area in Malaya was 6,475 acres, almost wholly in the Federated Malay States. This decreased still further later on, but more recent years have seen increased planting and in 1930 the total was set at 12,907 acres, of which 9,059 acres were in the Federated Malay States, 848 acres in the Straits Settlements, and 3,000 acres in Johore. Most of this, however, was interplanted with rubber, coconuts, etc. For 1933, the total coffee area in Malaya was stated to be 19,089 acres, of which 6,963 acres were in Johore and 6,020 acres in Selangor.

Imports of coffee into Malaya exceed exports by about 3,500 tons a year. In 1933, imports were 13,686,000 pounds and exports 5,833,000 pounds, both exclusive of the transshipment trade from one foreign country to another.

**BRITISH BORNEO.** Exports of coffee from British North Borneo have reached as high as 50,000 pounds, which was the figure in 1904. But in later years they have declined, and the territory has long been a coffee importer. The 1932 imports were 191,000 pounds, according to an unofficial report, and the exports practically nothing.

Sarawak likewise was once a small exporter of coffee, shipping out about 20,000 pounds a year before 1912. In that year an estate of 300 acres was abandoned and there have been no exports since. Im-

ports have become fairly heavy, amounting to 340,000 pounds in 1933, a typical year.

**PHILIPPINES.** Coffee raising was formerly one of the chief industries of the Philippines, but has greatly declined, partly because of blight. Exports reached their highest point in 1883, when 16,805,000 pounds were shipped. Since then they have fallen off steadily to nothing, and the islands have been importers for many years, although still producing considerable coffee for their own use. The area under cultivation in 1920 was 2,700 acres and the production in that year was given as 2,710,000 pounds, as compared with 1,580,000 pounds in 1919 and an average of 1,500,000 pounds for the previous five years. Since 1920, the acreage in coffee has remained much the same and production, while fluctuating from year to year, has averaged about the same as in that year. In 1932, there were 3,238,130 trees, occupying 3,199 acres and producing 2,402,000 pounds. Imports were 6,318,000 pounds in 1933. No export figures are available for that year, but exports ordinarily are negligible.

**GUAM.** Coffee is a common plant on the island of Guam but is not systematically cultivated. "Coffee growing in Guam," says the 1934 report of the Governor, "has never been developed properly. Many families produce small amounts of coffee for their own use and it appears the quality of the coffee is very good. Coffee thrives in Guam, requires little care and cultivation, and emphasis is being placed on growing more and more coffee, if not enough for export then certainly enough to supply local needs." A Navy report of several years ago said that the possible export was not less than 75 tons annually.

**HAWAII.** A certain amount of coffee has been produced in the Hawaiian Islands for many years, exports being recorded as 49,000 pounds in 1861; 452,000 pounds in 1870; and 143,000 pounds in 1877. The trees grow on all the islands, but nearly all the coffee produced is raised on Hawaii. The coffee has an excellent flavor. The amount of land planted to coffee on the island of Hawaii is now 5,000 to 6,000 acres, included in 1,200 farms. The industry could be greatly enlarged.

Exports of Hawaiian coffee go mostly to continental United States. Exports have been steadily increasing over a long

period. Up to 1909, they usually ranged between 1,000,000 and 2,000,000 pounds, and in the next ten or twelve years between 2,000,000 and 5,000,000 pounds, the 1921 total being 4,979,000 pounds. All export figures given here include exports to continental United States. In the five years 1930-34, they averaged 7,894,000 pounds, the 1934 total being 7,546,000 pounds, of which 5,468,000 pounds were sent to the United States mainland.

**AUSTRALIA.** Queensland is the only state of the Commonwealth in which coffee growing has been tried at all extensively, and there the results have been far from satisfactory. The area devoted to this crop reached its highest point in the season 1901-02 when 547 acres were recorded. In 1906-07, it was 256 acres, and it has since dropped to almost nothing, the 1932-33 season seeing only seven acres of productive planting, yielding 4,200 pounds. Australia has long been listed as a consuming coffee country and not as a producer.

**ETHIOPIA (ABYSSINIA).** This country, usually credited with being the original home of the coffee plant, still has in its southern parts vast forests of wild coffee whose actual extent is unknown but whose total production is believed to be immense. The yield is of inferior grade and reaches the market as "Abyssinian" coffee. There is also a large district of coffee plantations producing a very good grade called "Harari," which is considered almost, if not quite, the equal of the Arabian Mocha. This is usually shipped to Aden for re-export.

Ethiopia's coffee reaches the outside world through three gateways, and as the neighboring countries through which the produce passes also produce coffee no accurate statistics are available to show the country's annual export. The total, which formerly was estimated at 10,000,000 to 20,000,000 pounds a year, has greatly increased in post-war years. Exports of coffee through the French port of Jibuti, which are practically all Ethiopian coffee and represent the great bulk of exports from Ethiopia, have averaged 35,487,000 pounds in the five years 1928-32, and in 1932 they were 46,530,000 pounds. In 1914-16, before the present railway was completed, they were only 6,700,000 to 10,100,000 pounds. Ethiopian coffee exported through the Anglo-Egyptian Sudan has sometimes amounted to several million

pounds in a year, but usually the amount is less than a million pounds. Coffee exports from the Italian port of Massowah, Eritrea, which total some 5,000,000 to 7,000,000 pounds a year, include an unknown proportion of coffee from Ethiopia.

**KENYA.** The acreage in coffee has been mounting very rapidly in the last two decades. In 1911 it was estimated at 1,000 acres. By 1916, it had grown to 22,000 acres and by 1930-31 to about 100,000 acres, which is approximately the present area. Production increase has roughly paralleled growth in acreage. In the crop year 1929-30, the yield was about 22,400,000 pounds and in 1930-31 about 17,920,000 pounds. In 1932-33, production rose to 34,048,000 pounds, but because of drought conditions the estimate for 1933-34 was much lower—about 24,649,000 pounds.

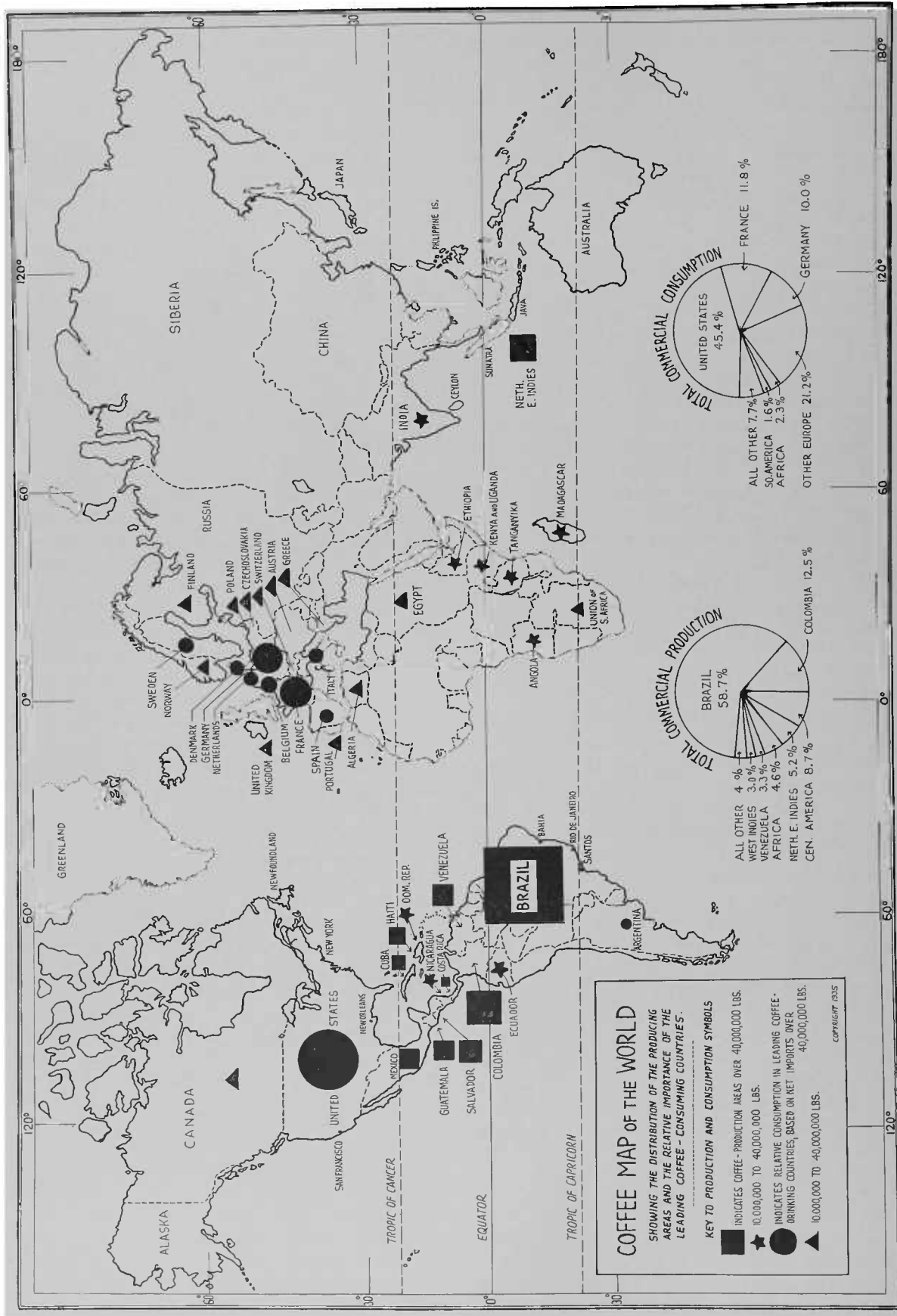
**UGANDA.** Coffee acreage has again been increasing in late years after a period of decline. In 1910 the area in coffee was 697 acres; 1914, 19,000 acres; 1916, 24,000 acres; 1917, 23,000 acres. Some years after the war the area decreased by about one-fourth, but by the crop year 1928-29 it had recovered all its losses, reaching 26,300 acres. In 1929-30 the total area was 36,113 acres divided as follows: In Arabica coffee, 19,147 acres, of which Europeans cultivated 12,968 acres, Asiatics 762 acres, and natives 5,417 acres; in Robusta coffee, 16,966 acres, including European 5,328 acres, Asiatic 667 acres, and native 10,971 acres. An unofficial report places the total area in 1932-33 at 42,027 acres. Production in 1932, as indicated by domestic exports, was 9,753,000 pounds and in 1933, 11,249,000 pounds.

**TANGANYIKA TERRITORY.** This is the former German East Africa, now administered as mandated territory by Great Britain. Before the war, it had some 7,700 acres in coffee, yielding an average of about 2,500,000 pounds a year. Both area and yield have increased ten- to fifteen-fold. The 1931 crop yielded about 20,722,000 pounds for export, that of 1932, 25,451,000 pounds, and that of 1933, 28,488,000 pounds. For 1934, the estimated yield, because of drought conditions, was reduced to about 21,000,000 pounds. The 1931-32 acreage was stated to be 117,775.

**NYASALAND PROTECTORATE.** Thirty-five or forty years ago this colony exported coffee in amounts ranging from 300,000 to more than 2,000,000 pounds. Production



ALL ABOUT COFFEE



then declined until in 1918 only 122,000 pounds were shipped, and over the next few years the average was only about 90,000 pounds. While production has been fairly well maintained since then, the tendency has been downward, especially in the last two or three years, rather than toward a revival. In 1931, the yield was 132,000 pounds, and in 1932, 86,000 pounds. The area in coffee in 1903 was 8,234 acres and in 1917, 1,237 acres. In 1932, it was 1,449 acres, of which only 531 acres were in bearing.

**NIGERIA.** Exports were 35,000 pounds in 1896; 57,000 pounds in 1901; and 70,000 pounds in 1909. In 1916 and 1917, however, they were only about 3,000 pounds, and they have since practically disappeared. The colony now imports about 21,000 pounds of coffee a year.

**SOMALI PROTECTORATE.** Exports of coffee were more than 7,500,000 pounds in 1897, indicating a very extensive production. But there was a steady decline until in 1918 only about 440,000 pounds were shipped. After the war the trade fell off still further until it almost disappeared. Then it revived, and during the last ten or twelve years it has been steadily growing. An unofficial report places the total exports in 1932 at 425,000 pounds.

**SOMALI COAST (FRENCH).** Coffee exports from the French Somali Coast consist of exports of Ethiopian coffee through the French port of Jibuti. In 1902, they were more than 5,000,000 pounds and in 1917, 11,200,000 pounds. The railway from the Ethiopian capital, Addis Ababa, to Jibuti was completed in 1917, and since then coffee exports from that port have increased four-fold, the total in 1932 being 46,530,000 pounds.

**SIERRA LEONE.** Exports in 1903 were 33,000 pounds, in 1913 17,000 pounds, and in 1917 8,000 pounds. The decline has continued until the trade has been practically wiped out.

**IVORY COAST, F. W. AFRICA.** Great efforts have recently been made to promote the cultivation of coffee in this French colony. The 1933-34 crop was 67,900 centals (6,790,000 lbs.) compared with 44,500 centals in 1933, 29,300 in 1932 and 10,700 in 1930.

**MAURITIUS.** In former times this island was an important coffee producer, exports in the early part of the nineteenth century running as high as 600,000 pounds a year. Today the export trade has disappeared

entirely, and instead the island imports 200,000 to 400,000 pounds of coffee annually. In 1929, however, it was reported that interest in coffee had been revived with the introduction of disease-resisting varieties, and that several comparatively large plantations had been started.

**REUNION.** This island also was once a notable grower of coffee. A century ago production was estimated as high as 10,000,000 pounds, and this rate of output continued well through the nineteenth century. In the present century, production has fallen off, only about 530,000 pounds being exported in 1909. The decrease has continued so that exports in recent years have been negligible, although in 1932 an exceptional figure of 45,000 pounds was reached. The island is now increasingly an importer of coffee, bringing in about a million pounds a year.

#### *Coffee Consumption*

Of the two million tons of coffee produced in the world each year practically all, with the exception of that which is used in the coffee-growing countries themselves, is consumed by the United States and western Europe, the British Dominions, and the non-producing countries of South America. Over that vast stretch of territory beginning with western Russia and extending over almost the whole of Asia, coffee is little known. In the consuming regions mentioned, moreover, consumption is concentrated in a few countries, which together account for eighty-five to ninety per cent of all the coffee that enters the world's markets. Arranged in order of quantity consumption, these are the United States, which now takes about one-half, and France, Germany, Belgium, Sweden, Italy, Netherlands, Denmark, Spain, and Argentina.

The United Kingdom is a conspicuous exception to the general rule that Western European countries are heavy consumers of coffee. The per capita consumption in that country is only about three-fourths of a pound each year. France and Germany are by far the biggest coffee buyers of Europe so far as actual quantity is concerned, though some of the other countries named drink more coffee in proportion to the total population.

The Mediterranean countries and the Balkans are of only secondary importance

## GENERAL COFFEE CONSUMPTION TABLE

(Figures for 1934 are in most cases preliminary)

<i>Country</i>	<i>Year</i>	<i>Imports (pounds)</i>	<i>Exports (pounds)</i>	<i>Consumption (pounds)</i>
United States (Continental) . . . . .	1934	1,531,137,000*	16,317,000*	1,514,820,000
Canada . . . . .	1934	34,026,000	58,000	33,968,000†
Newfoundland . . . . .	1934†	86,000	.....	86,000
United Kingdom . . . . .	1934	60,662,000	25,928,000	34,734,000†
France . . . . .	1933	392,247,000*	127,000	392,120,000
Spain . . . . .	1934	55,042,000*	17,000	55,025,000
Portugal . . . . .	1934	14,311,000	2,636,000	11,675,000†
Belgium . . . . .	1934	104,997,000*	81,000	104,916,000
Netherlands . . . . .	1934	93,210,000*	17,553,000	75,657,000
Denmark . . . . .	1934	62,467,000*	4,977,000	57,490,000
Sweden . . . . .	1934	100,040,000*	.....	100,040,000
Norway . . . . .	1934	35,867,000	205,000	35,662,000†
Finland . . . . .	1934	37,472,000	.....	37,472,000†
Russia . . . . .	1934	840,000	.....	840,000
Austria . . . . .	1934	11,913,000	.....	11,913,000†
Hungary . . . . .	1934	5,692,000	.....	5,692,000
Germany . . . . .	1934	332,518,000*	193,000	332,325,000
Czechoslovakia . . . . .	1933	20,448,000	.....	20,448,000†
Poland . . . . .	1934	15,061,000	.....	15,061,000†
Bulgaria . . . . .	1934	1,179,000	.....	1,179,000
Rumania . . . . .	1933	8,445,000	.....	8,445,000
Greece . . . . .	1934	12,164,000	.....	12,164,000†
Switzerland . . . . .	1934	30,787,000	622,000	30,165,000†
Italy . . . . .	1934	86,839,000*	33,000	86,806,000
Algeria . . . . .	1932	30,312,000	.....	30,312,000†
Tunis . . . . .	1933	3,758,000	.....	3,758,000
Egypt . . . . .	1934	14,586,000	.....	14,586,000†
Union of South Africa . . . . .	1934	26,931,000	1,680	26,930,000†
Northern Rhodesia . . . . .	1933	18,000	19,000	.....
Southern Rhodesia . . . . .	1933	141,000	10,000*	131,000
Mozambique . . . . .	1933	230,000	1,000	229,000
Ceylon . . . . .	1934	2,857,000	6,000	2,851,000
China . . . . .	1934	603,000	196	603,000
Japan . . . . .	1934	6,454,000	.....	6,454,000
Philippines . . . . .	1933	6,318,000	.....	6,318,000
Canary Islands . . . . .	1933	3,639,000	.....	3,639,000
Cyprus . . . . .	1933	814,000	.....	814,000
Australia . . . . .	1933†	3,585,000	46,000	3,539,000
New Zealand . . . . .	1933	465,000	.....	465,000
Martinique . . . . .	1933	584,000	80,000	504,000
Argentina . . . . .	1934	40,675,000*	.....	40,675,000
Chile . . . . .	1934	5,525,000	.....	5,525,000
Uruguay . . . . .	1933	6,826,000	.....	6,826,000
Paraguay . . . . .	1933	365,000	.....	365,000

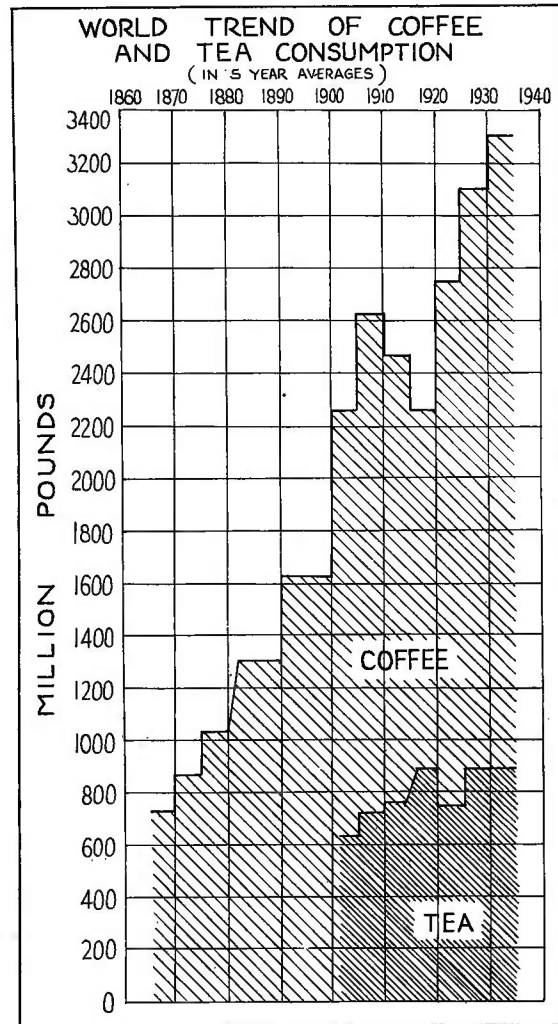
\* Including reexports. † Fiscal year.

as coffee drinkers, although in Italy the beverage is very popular and consumption would be much larger if prices were not so consistently high. Among the British dominions the Union of South Africa until recently took much the largest amount, doubtless because of the Dutch element in its population. But in the last few years Canada has taken first place in total consumption. Australia and New Zealand show the influence of the mother country, consumption per head being no larger than in England.

In South America, Brazil, Bolivia, and all the countries to the north are coffee producers. Of the southern countries Argentina is the chief coffee buyer, with Chile second. In the western hemisphere, however, the largest per capita coffee consumer is the island of Cuba, which now raises enough to supply its own needs and leave a surplus for export.

The list of coffee-importing countries, includes nearly all those that do not raise coffee, and also a few that have some coffee plantations but do not grow enough for their own use. These countries are listed on page 518. Consumption figures can be determined with fair accuracy in most cases from the import figures, although in some countries, where there is a considerable resale of imported goods, it is necessary to deduct export from import figures to obtain actual consumption figures. The trade statistics given are the latest available for each country named.

Per capita consumption figures for any given country as a rule do not change radically over a short period of years. During the war and the period of adjustment afterward there were naturally some wide fluctuations. But when trade resumed its normal course, per capita consumption in the various countries, with a few notable exceptions, swung back to about the same figures as before the war. Figures for each important consuming country, based on the amounts retained for consumption in the latest year for which returns are available, as given in the General Coffee Consumption Table, are presented in the accompanying Per Capita Consumption Table, together with pre-war per capita figures. It should be noted that, as per capita calculations must take into account population as well as amounts of coffee consumed, and as population figures are usually estimates, the results arrived at by different authorities



COFFEE AND TEA CONSUMPTION COMPARED—CHINA OMITTED (OFFICIAL STATISTICS LACKING)

are likely to vary slightly, although usually they are not far apart. In figuring the per capita amounts in the Per Capita Consumption Table, latest available estimates of population have been used. The figures show that the following are the ten leading countries in the per capita consumption of coffee in pounds (excluding the Union of South Africa, where coffee consumption by the white population is very high, but can not be determined from available statistics):

1. Sweden . . . . .	16.02	6. Norway . . . . .	10.57
2. Cuba . . . . .	15.99	7. Finland . . . . .	9.89
3. Denmark . . . . .	15.78	8. France . . . . .	9.28
4. Belgium . . . . .	12.58	9. Netherlands . . . . .	8.78
5. United States . . . . .	11.96	10. Switzerland . . . . .	7.29

The per capita consumption of the most important coffee-consuming countries, based on the General Consumption Table, is given in the Per Capita Consumption Table together with the 1913 figures for

comparison. It is to be noted that only official statistics have been used in compiling this table. Brazil is not included because no official figures are available. However, according to an unofficial survey, made in 1934 by an advertising agency, it appears that the per capita consumption of coffee stands high in Brazil; "an average being recorded as 9.219 kilos (roasted) or 20.32 pounds."

PER CAPITA COFFEE CONSUMPTION TABLE

Country	Year	Pounds	1913 Pounds
United States	1934	11.96	8.90 <sup>1</sup>
Canada	1934	3.13	2.17 <sup>1</sup>
Newfoundland	1934	0.29	0.19
United Kingdom	1934	0.74	0.61
France	1933	9.28	6.41
Spain	1934	2.25	1.64
Portugal	1934	1.75	1.16
Belgium	1934	12.58	12.27
Netherlands	1934	8.78	18.80
Denmark	1934	15.78	12.85
Norway	1934	10.57	12.29
Sweden	1934	16.02	13.41
Finland	1934	9.89	8.85
Russia	1934	0.005	0.16
Austria	1934	1.72	2
Hungary	1934	0.64	
Germany	1934	5.08	5.43
Czechoslovakia	1933	1.36	...
Rumania	1932	0.60	1.04
Greece	1934	1.80	1.19
Switzerland	1934	7.29	6.48
Italy	1934	2.05	1.79
Algeria	1932	4.56	...
Egypt	1934	0.96	1.15
Union of So. Africa	1934	3.30 <sup>3</sup>	4.19 <sup>3</sup>
Ceylon	1934	0.51	0.36
China	1934	0.001	0.001
Japan	1934	0.09	0.004
Cuba	1933	15.99 <sup>4</sup>	10.00
Argentina	1934	3.37	3.74
Chile	1934	1.23	3.04
Uruguay	1933	3.26	...
Paraguay	1931	0.36	...
Australia	1933 <sup>1</sup>	0.53	0.64
New Zealand	1933	0.30	0.29

<sup>1</sup> Fiscal year. Austria-Hungary, 1913, 2.54 pounds. <sup>3</sup> Based on total population, including native. On the basis of white population only the per capita figure for 1934 would be 14.02 pounds.

<sup>2</sup> Estimated.

#### *Tea and Coffee in England and the U. S.*

The rise of the United States as a coffee consumer in the last century and a half has been marked not only by steadily increased imports as the population of the country increased but also by a steady growth in per capita consumption, showing that the beverage has been continually

advancing in favor with the American people. Today each man, woman, and child in the United States has allotted to him some 12 pounds a year, enough for almost 500 cups. This is four times as much as it was a hundred years ago and more than twice as much as in the years immediately following the Civil War. In general it is fifty per cent more than the average in the twenty years preceding 1897, in which year a new high level of coffee consumption was apparently established, the per capita figure for that year being 10.04 pounds. In the years since then the per capita figure has seldom dipped below that amount.

During the period of fifteen years when national prohibition was in effect, from 1919 to 1933, per capita consumption averaged slightly over 12 pounds. During the fifteen years preceding 1919 the average was about 10.5 pounds. This increase may have been due in part to prohibition, but it is not likely that prohibition was anything more than a contributory factor. There was no spurt in coffee drinking when prohibition went into effect and no marked decrease when it was abandoned, so it is probable that the heavier consumption of coffee during the period was due to a natural growth in popularity that would have come about under any circumstances. The continued growth in the use of coffee in the United States has been in decided contrast to the record made by tea, the per capita consumption of which is only about half as much as it was half a century ago.

In the United Kingdom the reverse condition prevails. Tea drinking there steadily maintains a popularity that it has enjoyed for centuries, while coffee apparently makes no advance in favor. In this respect, the United Kingdom is sharply distinguished from its neighbors of western Europe, in some of which coffee drinking has been much heavier, considering the population, even than in the United States. The contrast in the tastes of the two countries in beverages is shown clearly by the per capita figures of tea and coffee consumption for seventy years, as given in the accompanying table.

#### *Coffee Consumption in Europe*

The countries of Europe in which coffee enjoys a popularity matching that which it holds in the United States are chiefly



those on the Atlantic seaboard and those fringing the Baltic Sea. The leading con-

TEA AND COFFEE CONSUMPTION  
PER CAPITA

Year	United States		United Kingdom	
	Coffee pounds	Tea pounds	Coffee pounds	Tea pounds
1870	6.00	1.10	.98	3.81
1875	7.08	1.44	.98	4.44
1880	8.78	1.39	.92	4.57
1885	9.60	1.18	.91	5.06
1886	9.36	1.37	.87	4.92
1887	8.53	1.49	.80	5.02
1888	6.81	1.49	.83	5.03
1889	9.16	1.25	.76	4.99
1890	7.77	1.32	.75	5.17
1891	7.94	1.28	.76	5.36
1892	9.59	1.36	.74	5.43
1893	8.23	1.32	.69	5.40
1894	8.01	1.34	.68	5.51
1895	9.24	1.39	.70	5.65
1896	8.08	1.32	.69	5.75
1897	10.04	1.56	.68	5.79
1898	11.59	.93	.68	5.83
1899	10.72	.97	.71	5.95
1900	9.84	1.09	.71	6.07
1901	10.43	1.12	.76	6.16
1902	13.32	.92	.68	6.07
1903	10.80	1.27	.71	6.04
1904	11.67	1.31	.68	6.02
1905	11.98	1.19	.67	6.02
1906	9.72	1.06	.66	6.22
1907	11.15	.96	.67	6.26
1908	9.82	1.03	.66	6.24
1909	11.43	1.24	.67	6.37
1910	9.33	.89	.65	6.39
1911	9.29	1.05	.62	6.47
1912	9.26	1.04	.61	6.49
1913	8.90	.96	.61	6.68
1914	10.14	.91	.63	6.89
1915	10.62	.91	.71	6.87
1916	11.20	1.07	.66	6.56
1917	12.38	.99	1.02	6.03
1918	10.43	1.40	1.19	6.75
1919	11.89	.62	.76	8.43
1920	11.68	.83	.72	8.44
1921	12.05	.69	.71	8.70
1922	11.04	.85	.74	8.69
1923	12.38	.92	.78	8.54
1924	12.23	.80	.78	8.82
1925	10.97	.87	.79	8.86
1926	12.61	.81	.77	8.92
1927	12.01	.74	.80	9.03
1928	12.03	.74	.78	9.16
1929	12.09	.73	.76	10.16
1930	12.75	.68	.77	9.87
1931	13.94	.69	.81	9.67
1932	11.90	.75	.76	10.52
1933	12.52	.76	.70	9.35
1934	11.96	.59	.74	9.42

Figures for all years except 1934 are taken from the *Statistical Abstract* publications of the two countries. For the United States figures up to and including 1918 apply to fiscal years and from 1919 to 1934 to calendar years. For the United Kingdom all figures are for calendar years. Since 1923 United Kingdom figures are exclusive of the Irish Free State.

tinental coffee ports are Hamburg, Bremen, Copenhagen, Amsterdam, Rotterdam, Antwerp, Havre, Bordeaux, Marseilles, and Trieste, and the nationality of these ports indicates pretty well the countries that consume the most coffee. The northern ports are transshipping points for large quantities of coffee going to the Scandinavian countries, as well as importing ports for their own countries, and the people of Scandinavia have long been among the leading coffee drinkers of the world. Norway, for example, in 1876 was consuming about 8.8 pounds of coffee per person, Sweden 5 pounds, and Denmark 5.2 pounds. The per capita consumption of various other countries at about the same period, 1875 to 1880, has been estimated as follows: Netherlands, 17.6 pounds; Belgium, 9.1 pounds; Germany, 5.1 pounds; Austria-Hungary, 2.2 pounds; Switzerland, 6.6 pounds; France, 3 pounds; Spain, 0.2 pounds; Portugal, 0.7 pounds; and Greece, 1.6 pounds.

Today the leading country of the world in point of per capita consumption is Sweden, with 16.02 pounds. The Netherlands was for a time the world leader in this respect, but during the war the disturbance of trade currents and the high price of coffee greatly reduced the amount of coffee drinking in that country, the Dutch turning to tea instead. Per capita consumption is now much lower there than in pre-war times.

FRANCE. Second only to the United States in total amount of coffee consumed is France, although that country before the war occupied third place, being passed by Germany. Havre is one of the great coffee ports of Europe and has a coffee exchange organized in 1882, only a short time after the exchange in New York began operations. France draws on all the large producing regions for its coffee but is especially prominent in the trade of the West Indies and the countries around the Caribbean Sea. Imports in 1933 amounted to 392,247,000 pounds, exports to 127,000 pounds, and net consumption to 392,120,000 pounds.

GERMANY. Hamburg is one of the world's important coffee ports, and coffee is brought there in vast amounts, not only for shipment into the interior of Germany but also for transshipment to Scandinavia and Finland. Up to the outbreak of the war Germany was the chief coffee-drinking

country of Europe. During the blockade the Germans resorted to substitutes, and following the war, because of high coffee prices, there was still some consumption of them. Through the difficult post-war period the trade slowly worked back toward its old levels, and both the total amount consumed and the per capita are now approaching pre-war figures. Importations in 1934, according to preliminary returns, were 332,518,000 pounds. Net consumption was 332,325,000 pounds and per capita consumption 5.08 pounds, whereas for the larger Germany of 1913 net consumption was 369,347,000 pounds and per capita 5.43 pounds.

**NETHERLANDS.** Netherlands is one of the oldest coffee countries of Europe, and for centuries has been a great transshipping agent, distributing coffee from its East Indian possessions and from America among its northern neighbors. Before sending these coffee shipments along, however, the country kept back enough to supply plentifully its own people. How large these supplies were can not well be determined. Prior to 1917 a considerable amount of the transit trade was included in the statistics of special commerce, and totals for both imports and exports before that date are not comparable with trade figures since. As indicated by the official statistics the amount of coffee retained annually for consumption before the war was about 94,000,000 pounds, and the per capita consumption was 15 to 16 pounds.

Since the trade worked back to normal channels after the severe dislocations caused by the war the annual amount retained for home consumption has been some 70,000,000 to 90,000,000 pounds. In 1934, it was 75,657,000 pounds, according to preliminary returns. In 1933, the amount was unusually large, 107,753,000 pounds; in 1932 it was 83,955,000 pounds. As the amount retained in 1934 was smaller than the average for recent years, the per capita of 8.78 pounds for that year is somewhat lower than the actual per capita of these times. A better index to current coffee consumption in the Netherlands would be the average for the last three years, which is 10.34 pounds.

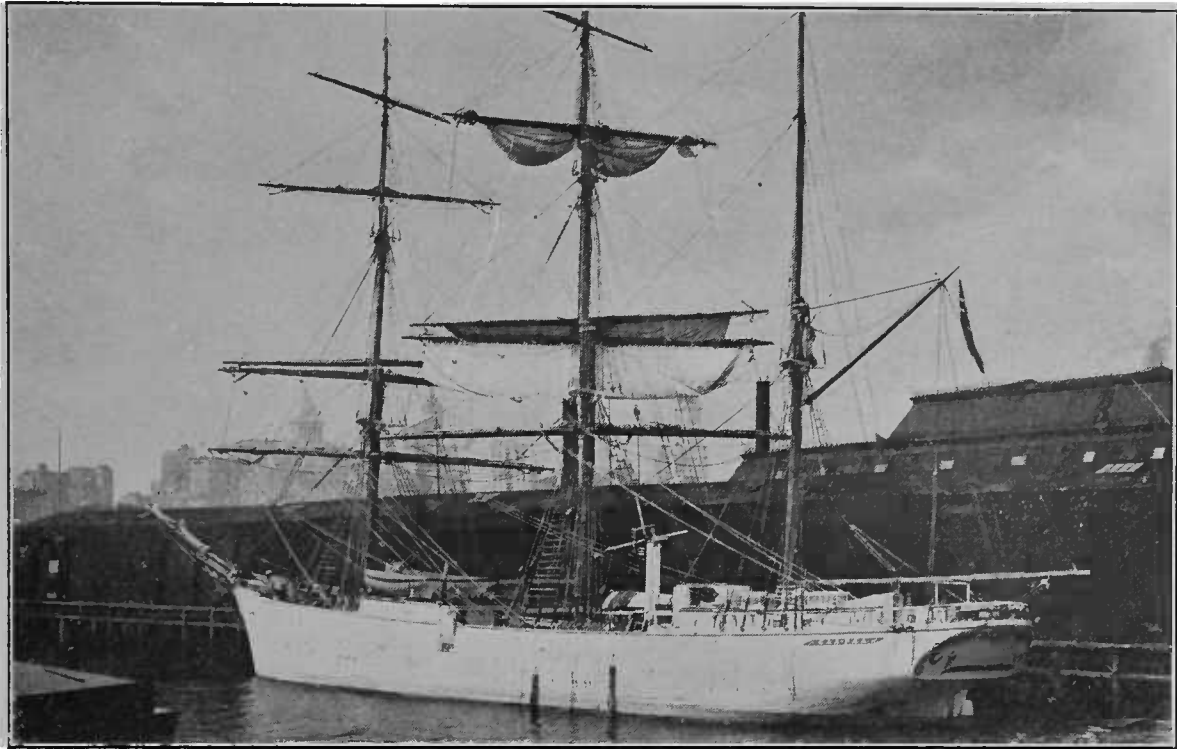
Seventy to eighty per cent of the Netherlands coffee trade is handled through Amsterdam. Forty per cent or more of the yearly imports come from Brazil, and about 30 per cent from the Netherlands

Indies. Out of the total imports for consumption of 93,210,000 pounds in 1934, Brazil supplied 40,377,000 pounds; the Netherlands Indies, 28,528,000 pounds; other American sources, 18,214,000 pounds; and Africa, 5,159,000 pounds.

**OTHER COUNTRIES OF EUROPE.** Denmark, Norway, and Sweden are heavy coffee drinkers. In 1934, Sweden had the highest per capita consumption in the world, 16.02 pounds. It was also highest in 1921, with 15.25 pounds. Before the war these three countries each consumed about as much per capita as the United States does today, 12 to 13 pounds. The 1934 net imports for consumption (preliminary) were as follows: Denmark, 57,490,000 pounds; Norway, 35,662,000 pounds; Sweden, 100,040,000 pounds. Before the war Austria-Hungary was an important buyer of coffee, large quantities coming into the country yearly through Trieste. Imports in 1913 totaled 130,951,000 pounds and in 1912 124,527,000 pounds. The post-war period brought drastic reductions in coffee consumption, the extent of which can not well be determined statistically because of territorial changes. However, per capita consumption, which was 2.54 pounds for Austria-Hungary in 1913, was only 1.72 pounds for Austria and 0.64 pounds for Hungary in 1934. Finland shares with its neighbors of the Baltic a strong taste for coffee, having a net importation in 1934 of 37,472,000 pounds, or about 9.89 pounds per capita. Belgium, with a net importation of 104,916,000 pounds in the same year, stood near the top in point of per capita consumption, which was 12.58 pounds.

Spain in 1934 consumed 55,025,000 pounds, while Portugal imported 14,311,000 pounds and exported 2,636,000 pounds, leaving 11,675,000 pounds for home consumption. Coffee importations are not heavy in the Balkan states. Italy, while fond of coffee, is not an especially large buyer considering the size of the population, the 1934 net imports being 86,806,000 pounds. Switzerland is a steady coffee drinker, consuming 30,165,000 pounds in 1934. Russia was never fond of coffee, but under the Soviets importations have become inconsiderable. A pre-war trade of some 25,000,000 pounds a year has shrunk to less than a million pounds.

**OTHER COUNTRIES.** The Union of South Africa in 1934 imported 26,930,000 pounds,



UNLOADING JAVA COFFEE FROM AN OLD-TIME SAILING VESSEL AT A BROOKLYN DOCK, NEW YORK  
The ship is the "Gaa Paa," which made the voyage from Padang in five months in 1912.

about 3.3 pounds per capita on the basis of total population. Argentina bought 40,675,000 pounds of coffee in 1934 and Chile 5,525,000 pounds. Australia imported 3,539,000 pounds net in the fiscal year 1933 and New Zealand 465,000 pounds in the calendar year.

#### *Three Centuries of Coffee Trading*

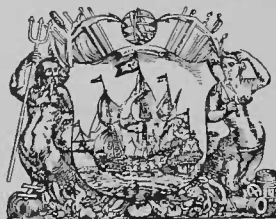
The story of the development of the world's coffee trade is a story of four centuries; from the time the use of coffee spread from Abyssinia and Arabia to countries east of the Mediterranean early in the sixteenth century, until the present. When Columbus sailed to the new world, the coffee plant was unknown even as near its original home as his native Italy. In its probable birthplace in southern Abyssinia the natives had enjoyed its use for a long time, and it had spread to southwestern Arabia; but the Mediterranean knew nothing of it until after the beginning of the sixteenth century. It then crept slowly along the coast of Asia Minor, through Syria, Damascus, and Aleppo, until it reached Constantinople, about 1554. It made its way against all opposition, and soon was firmly established in Turkey.

In those deliberate times, the next step westward, from Asia to Europe, was not taken for more than fifty years. In general, its introduction and establishment in Europe occupied the whole of the seventeenth century.

The greatest pioneering work in coffee trading was done by the Netherlands East India Company, which began operations in 1602. The enterprise not only promoted the spread of coffee growing in two hemispheres, but was active also in introducing its sale in many European countries.

Coffee reached Venice about 1615, and Marseilles about 1644. The French began importing coffee in commercial quantities in 1660. The Dutch began to import Mocha coffee regularly at Amsterdam in 1663. By 1679, the French had developed a considerable trade in the berry between the Levant and the cities of Lyons and Marseilles. Meanwhile the coffee drink had become fashionable in Paris, partly through its use by the Turkish ambassador, and the first Parisian *café* was opened in 1672. It is significant of its steady popularity since then that the name *café*, which is both French and Spanish for "coffee," has come to mean a general eating or drinking place.

# A 1790. OOST-INDISCHE COMPAGNIE.



De Wetvaardigheden van de Generale Nederlantsche Geconcerveerde Oost-Indische Compagnie / ter Vergadering van de Zeventien / presentreeren in de Maanden April en May dezes Jaars 1790. in de Respective Kameren / in 't Openbaar te veilen / de nabolgende Goederen / en dat by Verdeeling in de Kameren / en ten dage als volgt:

	In de Kamer Amsterdam op Maandag den 12 April 1790.	In de Kamer Zeland op Maandag den 19 April 1790.	In de Kamer Delft, op Dinsdag den 27 April 1790.	In de Kamer Rotterdam op Donder- dag den 29 April 1790.	In de Kamer Haarlem op Dinsdag den 4 Mey 1790.	In de Kamer Eindhoven op Donderdag den 6 Mey 1790.
5562 Baalen Bruyne Peeper	2470	1500	256	400	356	580
420600 g Caneel in Fardeelen	210600	105000	26250	26250	26250	26250
8000 -- Blanke Fouly	4000	2000	500	500	500	500
10000 -- Bruine dito	2000	6950	---	870	180	---
32000 -- Ongegarbuleerde Fouly	15375	8000	2000	2000	2000	2625
250000 -- Nagelen	125000	62500	15625	15625	15625	15626
100000 -- Geflooken Noten Muscaten	82760	3920	650	170	6250	6250
6000 ps Mannetges Nooten	2250	1500	---	750	750	750
500 -- Geconfyte dito	400	100	---	---	---	---
120000 g Sappanhout Bimaa's	35000	85000	---	---	---	---
10000 -- dito Java's	---	10000	---	---	---	---
179920 -- Poeder Suiker	---	179920	---	---	---	---
21875 -- Thin Bankas	---	21875	---	---	---	---
1124 -- Cardamom Java's	768	356	---	---	---	---
688 -- Lange Peeper	458	230	---	---	---	---
3525 Cubebe of Staartpeeper	2350	1175	---	---	---	---
1388 Sago Mallax	---	1388	---	---	---	---
47547 ps Handrottingen op Vragt	45178	2369	---	---	---	---
15000 g Carone Gaaren Java's	3625	11375	---	---	---	---
760000 -- Coffy Java's	200000	560000	---	---	---	---
2141 Thee op Vragt	2141	---	---	---	---	---

Als meede de Goederen van Particulieren, aangehouden Goederen en verdere Restanten en Kleinigheden, die by de Respective Kameren aan handen mogten zyn

De bovenstaande Bruine Peeper, Caneel, Fouly, Nagelen, geflooke Nooten Muscaten en Mannetges Nooten, worden Verkogt met een siffstand tot den Eerste Maart 1791. Egter behoudt de Compagnie aan haar de Facultyt om de Bruine Peeper, welke voor den Eerste April 1790 nog mogt worden aangebragt, ten allen tyden te mogen Verkoopen; en worden alle de andere aangeleggen Goederen, met de Gereserveerde Scheepen aangebragt (en by het Najaars Verkoopbillet vermeld) Verkogt met een siffstand tot den Eerste Augustus 1790.

Te Amsterdam, by NICOLAAS BYL, op den Nieuwendyk, Drukker van de Oost-Indische Compagnie.  
Gedruckt den 18 February 1790. Met Privilegie.

**BILL OF PUBLIC SALE OF COFFEE, ETC., 1790**  
Reproduction of an advertisement by the Dutch East India Company.

Active trading in coffee began in Germany about 1670, and in Sweden about 1674.

Coffee trading in England followed swiftly upon the heels of the opening of the first London coffee house in 1652. By 1700, the trade included not only exporting and importing merchants but also wholesale and retail dealers, the latter succeeding the apothecaries, who, up to then, had enjoyed a monopoly of the business.

Trade and literary authorities on coffee-trading tell us that in the early days of the eighteenth century the chief supplies of coffee for England and western Europe came from the East Indies and Arabia. The Arabian, or—as it was more generally known—the Turkey berry, was bought first-hand by Turkish merchants, who were accustomed to travel inland in Arabia Felix, and to contract with native growers.

It was moved thence by camel transport through Judea to Grand Cairo, via Suez, to be transshipped down the Nile to Alexandria, then the great shipping port for Asia and Europe. By 1722, 60,000 to 70,000 bales of Turkish (Arabian) coffee a year were being received in England, the sale price at Grand Cairo being fixed by the Bashaw, who “valorized” it according to the supply. “Indian” coffee, which was also grown in Arabia, was brought to Bettelfukere (Beit-el-fakih) in the mountains of southwestern Arabia, where English, Dutch, and French factors went to buy it and to transport it on camels to Mocha (Mocha), whence it was shipped to Europe around the Cape of Good Hope.

In the beginning, the best Arabian coffee was known as “Turkish” and the poorer grades as “Indian.” “Indian” coffee was inferior to “Turkish” because it was the refuse, or what remained after the Turkish merchants had taken the best. But after the European merchants began to make their own purchases at Bettelfukere, the character of the “Indian” product as sold in the London and other European markets was vastly improved. Doubtless the long journey in sailing vessels over tropic seas made for better quality. It was estimated that Arabia in this way exported about a million bushels a year of “Turkish” and “Indian” coffee.<sup>1</sup>

The coffee houses became the gathering

places for wits, fashionable people, and brilliant and scholarly men, to whom they afforded opportunity for endless gossip and discussion. It was only natural that the lively interchange of ideas at these public clubs should generate liberal and radical opinions, and that the constituted authorities should look askance at them. Indeed the consumption of coffee has been curiously associated with movements of political protest in its whole history, at least up to the nineteenth century.

Coffee has promoted clear thinking and right living wherever introduced. It has gone hand in hand with the world's onward march toward democracy.

As already told in this work, royal orders closed the coffee houses for short periods in Constantinople and in London; Germany required a license for the sale of the beverage; the French Revolution was fomented in coffee-house meetings; and the real cradle of American liberty is said to have been a coffee house in New York. It is interesting also to note that, while the consumption of coffee has been attended by these agitations for greater liberty for three centuries, its production for three centuries, in the Netherlands East Indies, in the West Indies, and in Brazil, was largely in the hands of slaves or of forced labor.

Since the spread of the use of coffee to western Europe in the seventeenth century, the development of the trade has been marked, broadly speaking, by two features: (1) the shifting of the weight of production, first to the West Indies, then to the East Indies, then to Brazil; and (2) the rise of the United States as the chief coffee consumer of the world. Until the close of the seventeenth century, the little district in Arabia whence the coffee beans had first made their way to Europe continued to supply the whole world's trade. But sprigs of coffee trees were beginning to go out from Arabia to other promising lands, both eastward and westward. As previously related, the year 1699 was an important one in the history of this expansion, as it was then that the Dutch successfully introduced the coffee plant from Arabia into Java. This started a Far Eastern industry whose importance continues to this day, and it also caused the mother country, the Netherlands, to take on the rôle of one of the leading coffee traders of the world, which she still holds.

<sup>1</sup> Broadbent, Humphrey. *The Domestic Coffee Man*. London, 1720. Bradley, Richard. *The virtue and use of coffee with regard to the plague and other infectious distempers*. London, 1721.



The Netherlands, in fact, took to coffee from the very first. It is claimed that the first samples were introduced into that country from Mocha in 1616—long before the beans were known in England or France—and that by 1663 regular shipments were being made. Soon after coffee culture became firmly established in Java regular shipments to the mother country began, the first of these being a consignment of 894 pounds in 1711. Under the auspices of the Netherlands East India Company the system of cultivating coffee by forced labor was begun in the East Indian colonies. It flourished until well into the nineteenth century. One result of this colonial production of coffee was to make the Netherlands the leading coffee consumer per capita of the world. It has long been one of the leading coffee traders. Before the world war it imported at times as much as 300 million pounds in a single year, a large percentage of which was resold to neighboring countries.

The introduction of the coffee plant into the new world took place between 1715 and 1723. It quickly spread to the islands and the mainland washed by the Caribbean. The latter part of the eighteenth century saw tens of millions of pounds of coffee being shipped yearly to the mother countries of western Europe, and for decades the two great coffee trade currents of the world continued to run from the West Indies to France, England, the Netherlands, and Germany, and from the Netherlands East Indies to the Netherlands. These currents have continued to flow until the present time, except for a few years' disruption by the world war. But they have long ago been pushed into positions of secondary importance by the establishing of two new currents, running respectively from Brazil to Europe and from Brazil to the United States, which constituted the nineteenth century's contribution to the history of the world's coffee trade.

A notable feature of the twentieth century's developments has been the passing by the United States of the half-way mark in the world consumption, this country, since the second year of the world war, having taken consistently, year after year, about as much as all the rest of the world put together. The world's chief coffee "stream," so to speak, is now from Santos and Rio de Janeiro to New York. Other lesser streams are from Colombian and

Venezuelan ports to New Orleans and New York, and to Europe; from Brazil to Havre, Antwerp, Amsterdam, and Hamburg; and from Java to Amsterdam and Rotterdam.

The rise of Brazil to the place of greatest importance as a source of the world's coffee was entirely a nineteenth-century development. When the coffee tree found its true home in southern Brazil in 1770, it began at once to spread widely over the area of excellent soil; but there was little exportation for thirty or forty years. By the middle of the nineteenth century Brazil was contributing twice as much to the world's commerce in coffee as her nearest competitor, the Netherlands Indies. Exports in 1852-53 were 2,353,563 bags from Brazil and 1,190,543 bags from the Netherlands Indies. The world's total that year was 4,567,000 bags, Brazil coffee thus representing about one-half the total. The proportion was roughly maintained during the latter half of the nineteenth century, but since then it has gradually increased to its present two-thirds to three-fourths.

The outstanding feature of Brazilian production during the present century has been the long struggle to regulate the output and marketing of the coffee crop, first by great "valorization" schemes and more recently by a program of continuous "defense."

The first valorization plan was initiated in 1906 by the State of São Paulo. In that and succeeding years a total of 10,868,266 bags of coffee were purchased and stored in Santos, New York, and certain European ports in order to stabilize the price in the face of very heavy production. New planting for a term of years had been prohibited since 1902, and a limitation on yearly exports was also in effect for a while. The story of this and later valorization and defense efforts is told more fully in Chapter XXXI. The coffee thus purchased by the state was placed in the hands of an international committee, which fed it into the market at good prices over several years, so that the plan was successful not only financially but in preventing the ruin of planters through overproduction.

Another valorization campaign was launched in 1918, and a third in 1921. Both were not only successful but through enhanced prices were highly profitable. The good results from these plans led the government of the State of São Paulo to set

TREND OF EUROPEAN COFFEE CONSUMPTION  
FOR EIGHTY YEARS

Year	Germany (pounds)	France (pounds)	Netherlands <sup>1</sup> (pounds)	Aus.-Hung. (pounds)	Belgium <sup>1</sup> (pounds)
1853	104,049,000	48,095,000	46,162,000	44,716,000	41,270,000
1863	146,969,000	87,524,000	30,299,000	44,966,000	39,305,000
1873	215,822,000	98,841,000	79,562,000	71,111,000	49,874,000
1883	251,706,000	150,468,000	130,380,000	74,145,000	62,846,000
1893	269,381,000	152,203,000	75,562,000	79,438,000	52,046,000
1903	403,070,000	246,122,000	78,328,000	104,200,000	51,859,000
1913	369,347,000	254,102,000	116,749,000	130,951,000	93,250,000
1923	85,385,000	378,994,000	69,125,000	.....	90,534,000
1933	285,888,000	392,120,000	107,754,000	.....	87,509,000

<sup>1</sup> Pre-war figures for the Netherlands and Belgium not comparable with post-war figures as they formerly included a considerable amount of "hidden" transit trade.

up machinery for the continuous regulation of coffee marketing, which was entrusted to the State-controlled Institute for the Permanent Defense of Coffee. It stored large quantities of coffee in interior warehouses, made loans to planters, and closely restricted entries into ports. For several years the plan functioned well, but the world economic collapse of 1929, combined with unexpectedly heavy production, brought disaster which led to changes in control and policy. In February, 1933, the problem of dealing with the distressing coffee situation was placed in the hands of the Departamento Nacional do Café, a part of the Ministry of Finance. Within two years the DNC has raised the coffee situation from a state of bankruptcy to a position of temporary stability and security, with every effort being made for its permanency. The striking feature of the new policy has been the outright destruction of immense quantities of coffee. Up to April 30, 1935, 34,971,000 bags of coffee had been destroyed.

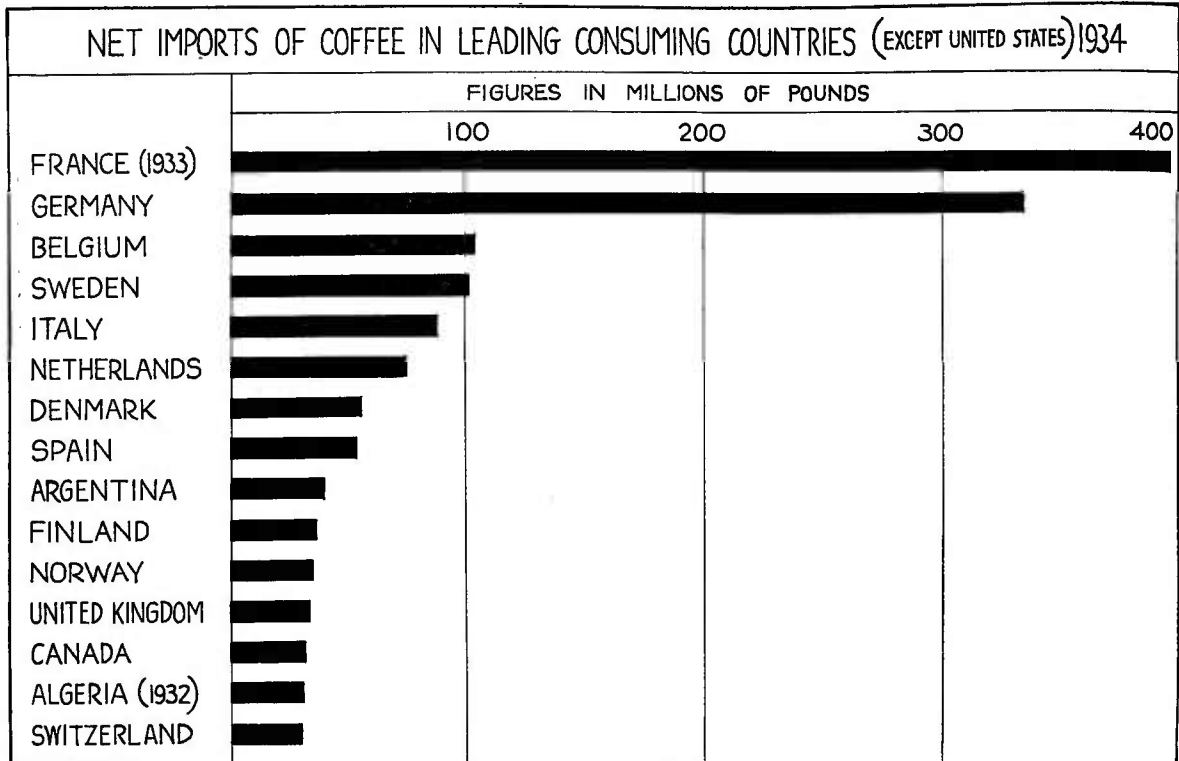
European consumption during the last century has been marked by the growth of imports into France and Germany, these being the two leading coffee drinkers of the world aside from the United States. Germany held the lead in European consumption during the whole of the nineteenth century, and also in the present century until all imports were stopped by the allied navies. For five or six years after the war her trade picked up slowly. But in 1923 and 1924 it began to climb rapidly toward the former large figures and for a number of years there was a continual advance. But the yearly total of imports never reached pre-war figures, and Germany has

continued to be second to France in the list of coffee consumers.

In actual gross imports the Netherlands, even before the war, led all other European countries. But both the Netherlands and England have long acted as distributors, re-exporting each year most of the coffee which entered their ports.

In the half-century before the World War the chief European consumers, in the order named, were Germany, France, the Netherlands, Austria-Hungary, and Belgium, although for the years immediately preceding the war Austria-Hungary occupied third place. Since the war the trade has been featured by the prominence as coffee consumers of Italy and Sweden, which at various times have occupied third and fourth places in the list of net imports. In general, France has led the coffee-consuming countries of Europe since the war, followed in the last ten years or so by Germany, and then by Italy, Sweden, Belgium, and the Netherlands in a changing order of precedence. The above table shows the general trend of the trade in the last eighty years.

For many years, most of the coffee for these countries has been supplied by Brazil, even the Netherlands bringing in considerably more from Brazil than from her own East Indies. Special features of the pre-war trade in Europe were the organization, in Germany in 1873, and the successful operation, of the world's first international syndicate to control the coffee trade; and the opening of coffee exchanges in Havre in 1882, in Amsterdam and Hamburg in 1887, in Antwerp, London, and Rotterdam in 1890, and in Trieste in 1905.



The advance of coffee consumption in the United States, the chief coffee-consuming country in the world, has taken place through about the same period as the advance of production in Brazil, the chief producing country; but it has been far less rapid. From 1790 to 1800 our coffee imports for consumption ranged from 3,500,000 to 32,000,000 pounds. The figures on the next page show the net importations of coffee into this country since the beginning of the nineteenth century.

The chief source of supply, of course, has been Brazil, and the commercial and economic ties created by this immense coffee traffic has knit the two countries closely together. Brazil is probably more friendly to the United States than any other South American country, as shown, among other ways, by her action in following the United States into the war against Germany. She also grants the United States certain tariff preferentials as a recognition of the continued policy of this country of admitting coffee free of duty. The chief port of entry of coffee into the United States is New York, which for decades has recorded entries amounting to fifty to ninety per cent of the country's total. Since the beginning of the century New Orleans has figured very prominently in the import trade,

reaching at times as much as thirty-five per cent of the total. The only other port of importance is San Francisco, which owes its large coffee business to a flourishing trade with Central America and Hawaii.

Throughout the century and a half of steady increase of importations of coffee, Congress has for the most part permitted its free entry. As a rule, it has resorted to taxation of "the poor man's breakfast cup" only when in need of revenue for war purposes.

Before the Civil War the country's coffee trade was without special incident. But since that time the continued growth has brought about manipulations that often have resulted in highly dramatic crises; organizations to exercise some sort of regulation in the trade; the development of a trade in substitutes; the advance of the sale of branded package coffee; the institution of large advertising campaigns; and other interesting features. These are treated more in detail in the chapters that follow.

#### *Coffee Drinking in the United States*

Is the United States using more coffee than formerly, allowing for the increase in population? Of course, there are sporadic

increases, in particular years and groups of years, and they may indicate to the casual observer that our coffee drinking is mounting rapidly. And then there is the steadily growing import figure, double what it was within the memory of a man still young.

But the apparent growth in any given year is a matter of comparison with a near-by year, and there are declines as well as jumps; and as for the gradual growth, it must always be remembered that, according to the Census Bureau, some 800,000 or 900,000 more people are born or enter the country every year than are removed by death or emigration. At the present rate this increase would account for about 11,000,000 pounds more coffee each year than was consumed in the year before.

The question is: Do Mr. Citizen, or Mrs. Citizen, or the little Citizens growing up into the coffee-drinking age, pass his or her or their respective cups along for a second pouring where they used to be satisfied with one; or do they take a cup in the evening as well as in the morning; or do they perhaps have it served to them at an afternoon reception where they used to get something else? In other words, is the coffee habit becoming more intensive as well as more extensive?

There are plenty of very good reasons why it should have become so in the last thirty or forty years; for the improvements in distributing, packing, and preparing coffee have been many and notable. It is a far cry these days from the time when the housewife snatched a couple of minutes from a hundred other kitchen duties to set a pan over the fire to roast a handful of green coffee beans, and then took two or three more minutes to pound or grind the crudely roasted product into coarse granules for boiling.

For a good many years, the keenest wits of the coffee merchants, not only in the United States but in Europe as well, have been at work to refine the beverage as it comes to the consumer's cup. And their success has been striking. Now, the consumer can have his favorite brand not only roasted but packed air-tight, to preserve its flavor; and made up, moreover, of growths brought from the four corners of the earth and blended to suit the most exacting taste. He can buy it already ground, or he can have it in the form of a soluble powder. He can even get it with

COFFEE IMPORTS INTO THE U. S. A.  
FOR 130 YEARS

<i>Net Imports</i>			
<i>Year</i> <sup>1</sup>	<i>Pounds</i>	<i>Year</i> <sup>1</sup>	<i>Pounds</i>
1800...	8,792,000	1917...	1,264,556,000
1811...	19,801,000	1918...	1,080,358,000
1821...	11,886,000	1919...	1,248,285,000
1830...	38,363,000	1920...	1,244,897,000
1840...	86,298,000	1921...	1,303,546,000
1850...	129,791,000	1922...	1,213,362,000
1860...	182,050,000	1923...	1,380,334,000
1870...	231,174,000	1924...	1,384,545,000
1880...	440,129,000	1925...	1,259,768,000
1890...	490,162,000	1926...	1,468,888,000
1900...	748,801,000	1927...	1,420,095,000
1910...	860,415,000	1928...	1,441,542,000
1911...	869,951,000	1929...	1,469,255,000
1912...	880,548,000	1930...	1,570,563,000
1913...	868,919,000	1931...	1,729,279,000
1914...	992,551,000	1932...	1,484,945,000
1915...	1,055,089,000	1933...	1,573,117,000
1916...	1,128,023,000	1934...	1,512,137,000

<sup>1</sup> Fiscal year to and including 1918; 1919-34, calendar year.

the caffeine element ninety-nine per cent removed. It is preserved for his use in paper, tin, fiber or glass containers, with wrappings whose attractive designs seem to add something in themselves to the quality. Instead of the old coffee pot, black with long service, he has modern shining percolators and filtration devices, with a new one coming out every little while to challenge even these. Last but not least, he is being educated to make his coffee properly—tuition free.

It would be surprising, with these and dozens of other refinements, if a far better average cup was not produced than was served forty years ago, or if the coffee drinker did not show his appreciation by coming back for more.

FIVE-YEAR PER CAPITA CONSUMPTION IN  
CONTINENTAL U. S. A.

<i>Five-year Period</i>	<i>Per capita Pounds</i>	<i>Five-year Period</i>	<i>Per capita Pounds</i>
1865-69.....	5.01	1900-04.....	11.21
1870-74.....	6.86	1905-09.....	10.82
1875-79.....	6.93	1910-14.....	9.38
1880-84.....	8.63	1915-19.....	11.32
1885-89.....	8.62	1920-24.....	11.88
1890-94.....	8.31	1925-29.....	11.94
1895-99.....	9.93	1930-34.....	12.61

As a matter of fact, the figures show that he does come back for more. We do not refer to the figures for the last few

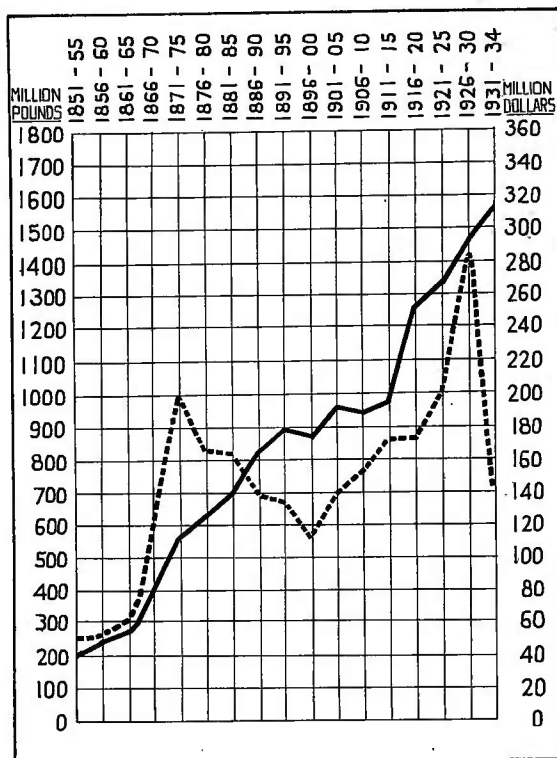


CHART OF COFFEE IMPORTS

Quantity and value of net imports into the United States for the years 1851-1934 in five-year averages. Solid line represents quantity, figures in million pounds on left side. Dotted line represents value; figures in million dollars on right side.

years, which indeed are higher than those for many preceding years, but to the only averages that are of much significance in this connection; namely, those for periods of years going back half a century or more. Five-year averages back to the Civil War show increasing per capita consumption for continental United States (see table on page 529).

It will be seen that the gain has been a decided one, fairly steady, but not exactly uniform. In the last sixty or seventy years John Doe has just about come to the point where he hands up his cup for a second helping and keeps a meaningful silence. Heretofore he has been stipulating, "Don't fill it quite full this time—fill it about one-half, or three quarters, as full as it was before." Now, while he keeps silent, a full second cup is poured. In other words, in addition to a great growth of population, which has more than trebled the number of American citizens, the United States has just about doubled its allowance of coffee for each man, woman, and child within its borders, counting from the days of Grant's early Presidency. That is a

remarkable gain, and one that the next six or seven decades can hardly be expected to duplicate, in spite of the efforts of our coffee advertisers, our inventors, and our vigorous importers and roasters.

The most striking feature of this sixty-five-year growth was the heavy increase in consumption toward the close of the last century and the beginning of the present one. In 1890, the per capita figure was 7.77 pounds. In the five years 1900-04 it was averaging 11.2 pounds, having reached as high as 13.3 pounds in 1902, although that figure was due to abnormal importations rather than excessive consumption. From the beginning of the present century through the world war, per capita consumption remained fairly steady at around 11 pounds. But in the years since the war there has been a slow but perceptible gain, which has brought the average of the last five years to about twelve and three-quarter pounds. In 1933, it stood at about 12.5 pounds and in 1934 at 11.96 pounds.

In this connection it should be noted that the government's per capita coffee figures apply only to continental United States, and that in computing them all the various items of trade of the non-contiguous territories Alaska, Hawaii, and Puerto Rico (but not the Philippines, whose statistics are kept entirely separate from those of the United States proper) are carefully taken into account.

But for the benefit of students of coffee figures it should be added that this method does not result in a final figure except for one year in ten. The reason is that between censuses the population of the country is determined only by estimates, and these estimates (by the U. S. Bureau of the Census) are based primarily on the average increase shown in the preceding census decade. The increase between 1920 and 1930, for instance, was 17,064,000, or an average gain of 1,706,400 a year. This forms a starting point for estimating the increase in each succeeding year after 1930, and the estimated total as announced by the Bureau of the Census is the figure used in computing per capita coffee consumption. But when the 1940 figures are in, it may be found that the estimates were too low or too high, and the per capita figures for the ten previous years will accordingly be subject to revision. This will not amount to much, probably only to a few hundredths of a pound; but it is evident that between



1930 and 1940 all per capita figures issued by the government are to be considered as provisional to that slight extent, at least.

Because of drastic immigration restriction, and because of the lower birth rate which usually accompanies years of economic depression, the estimates of population increase have been cut to a much lower figure since 1930 than that shown in the 1920-30 decade. Between 1930 and 1933 the total estimated gain was 2,502,000, or about 813,000 a year. Population experts seem to be agreed that this country is approaching a time of stationary population, and that the time is only a few decades ahead. Our gain in coffee consumption from year to year is thus depending increasingly on higher per capita consumption rather than population growth, and presently, if the experts are right, that will be the only factor making for increased imports.

*Reviewing the 1934 Coffee Trade in the United States*

Coffee imports into the United States in the calendar year 1934 were somewhat below those of 1933. The 1934 total stood at 1,523,994,000 pounds, as compared with 1,586,254,000 pounds in 1933, a drop of 3.9 per cent. But the 1934 imports were still somewhat higher than those of 1932 and well above the average of the preceding ten years (see table, page 532).

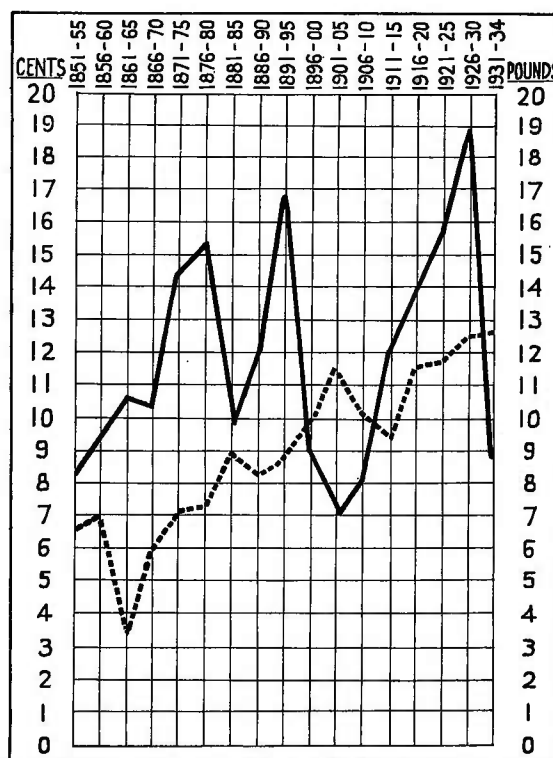
The influence of higher prices was to be seen in the figure of total valuation of coffee imports. In the face of decreased volume of shipments the aggregate value of 1934 imports exceeded that of the 1933 trade by 7.3 per cent, the 1934 total being \$133,154,000 as against \$124,137,000 in the preceding year. Except for 1933, however, the amount paid for purchases of coffee in 1934 was less than for any other year in the preceding decade, and was less than one-half of the annual coffee bill in the era of high prices before the depression. The table on page 533 shows comparative figures since 1925.

Prices were consistently higher in 1934 than in the year before. The record of spot prices shows that a level about two cents higher than in 1933 was maintained throughout the year. The lowest monthly average for Rio No. 7 (New York quotations) was 9.1 cents in January and the highest 10.9 cents in March, and for San-

tos No. 4, 10.2 cents in January and 11.7 cents in March. The year's average for the Rio grade was 9.8 cents. This was the highest mark reached since 1929, as shown by the following: 1934, 9.8 cents; 1933, 7.8 cents; 1932, 8.1 cents; 1931, 6.2 cents; 1930, 8.7 cents; 1929, 15.7 cents. For the Santos grade quotations over the full year 1934 averaged 11.2 cents, which was the best average since 1930.

Although the total valuation of U. S. coffee imports in 1934 was far below the levels reached in pre-depression years, coffee retained its position as the most valuable single commodity imported into the United States. Coffee has led all other imports in value since 1932.

The reduction in volume of 1934 imports as compared with 1933 was in evidence with all western sources of supply, while shipments from the Far East more than doubled. The latter gain, however, was due to unusually low shipments in 1933. In point of value the Netherlands possessions in the Far East and Aden registered good gains, and in the west Brazil and Venezuela received more for their coffee



CONSUMPTION AND PRICE CHART, 1851-1934

Import price and per capita consumption of coffee in the United States in five-year averages. Solid line represents import price per pound. Dotted line represents consumption.

## PERCENTAGE OF U. S. COFFEE IMPORTS FROM PRINCIPAL SOURCES

During Three Calendar Years

	1932		1933		1934		Percentage increase (+) or decrease (-) 1934 over 1933	
	Quantity	Value	Quantity	Value	Quantity	Value	Quantity	Value
Central America .....	3.2	3.6	4.1	4.7	3.9	4.4	-7.9	-0.8
Mexico .....	1.4	1.8	3.3	4.1	2.4	3.0	-29.7	-21.0
West Indies .....	0.8	0.1	0.3	0.4	0.1	0.2	-62.8	-52.5
Brazil .....	61.5	50.7	65.8	54.3	65.6	56.2	-4.1	+10.9
Colombia .....	23.8	34.0	22.6	32.0	21.1	29.1	-10.5	-2.4
Venezuela .....	3.9	3.6	1.9	2.4	1.9	2.3	-3.4	+3.6
Aden .....	0.2	0.2	0.1	0.2	0.2	0.2	+5.2	+20.3
Netherlands East Indies ..	3.9	3.2	0.7	0.8	1.8	1.8	+140.2	+129.1
Other countries .....	1.3	2.8	1.2	1.1	3.0	2.8	....	....
Total .....	100.0	100.0	100.0	100.0	100.0	100.0	-3.9	+7.3

sales to this country than in 1933. All of the other sources recorded decreases.

Brazil's share of our trade was about two-thirds in point of volume and somewhat more than one-half in point of value. Total 1934 shipments were 999,869,000 pounds, valued at \$74,805,000, as against 1,043,008,000 pounds valued at \$67,444,000 in 1933. These figures, showing a loss of 4 per cent in quantity and a gain of 11 per cent in value, represent an increase in unit value of 1 cent per pound (based on valuations at port of shipment), the average working out at 7.5 cents in 1934 and 6.5 cents in 1933.

One of the avowed objects of Brazilian regulation measures has been the spread of the marketing of coffee crops not only over the twelve months of the year but also from one year to another. A review of the trade statistics of the last ten years reveals that, so far as the United States is concerned, at least, this object has been to a very large extent achieved. In the last nine or ten years our coffee imports from Brazil have remained around one billion pounds a year, the only notable exception being in 1931 when the traffic rose to 1,236,000,000 pounds. There has been little or no indication in the statistical record of a major depression, currency changes, etc., in the United States or of political revolution, price collapse, excessive production, or the institution of such drastic control measures as the destruction of millions of bags of coffee a year in Brazil. How close was the 1934 trade to the stabilized level is shown by the fact that the 1934 volume of 999,869,000 pounds checks with an average in the last ten years of 1,007,460,000 pounds. The steady flow of this traffic is likewise apparently independent of steep price fluctuations. Over the ten-year period

prices have suffered a reduction of more than two-thirds. In 1926 Brazil realized \$199,663,000 from its coffee sales to this country and in 1933 only \$67,444,000. Yet the actual imports in those two years were practically the same in terms of pounds. It is doubtful if the traffic in any other major commodity in international trade can show as firm stabilization.

Imports of coffee from Colombia in 1934 followed the general trend and receded both in quantity and value. They totaled 321,486,000 pounds as against 359,237,000 pounds in 1933, a drop of 10.5 per cent, and their value stood at \$38,810,000 as against \$39,762,000, a decrease of 2.4 per cent. The 1934 trade marked the lowest point as regards volume which the U. S. imports of Colombian coffee have reached since 1929, and as regards value since 1923. The record, however, is less deflationary in character than these statements would indicate, as coffee imports from Colombia, like those from Brazil, have become fairly stabilized, and the volume of business in 1934 was not far from the average in recent years. The present level covers a period of six years. Prior to 1929 average imports from Colombia were 250,000,000 pounds a year, and since that time they have been 338,109,000 pounds, which is but little above the 1934 figure. Within these half-dozen years, however, the value has been cut in half, the curve being steadily downward from the high point of \$78,811,000 in 1929 to the \$38,810,000 of 1934.

Among the secondary sources of supply in the western hemisphere Venezuela made the best record in maintaining its sales to the United States. Its 1934 total of 29,209,000 pounds compared with 30,227,000 pounds in the year before, a reduction of only 3.4 per cent. In point of value there

U. S. IMPORTS OF COFFEE FROM BRAZIL AND COLOMBIA

During the Last Ten Calendar Years

Year	Brazil		Colombia	
	Pounds	Value	Pounds	Value
1925	871,889,000	\$184,793,000	212,237,000	\$54,915,000
1926	1,013,344,000	199,663,000	272,458,000	74,279,000
1927	1,022,986,000	164,773,000	252,173,000	65,585,000
1928	960,946,000	189,839,000	264,214,000	69,592,000
1929	956,041,000	178,356,000	311,518,000	78,811,000
1930	1,047,301,000	107,486,000	354,114,000	72,466,000
1931	1,236,123,000	91,451,000	324,809,000	59,569,000
1932	923,092,000	69,326,000	357,419,000	46,477,000
1933	1,043,008,000	67,444,000	359,237,000	39,762,000
1934	999,869,000	74,805,000	321,486,000	38,810,000

was an actual gain of about as much, the 1934 figures being \$3,039,000 and those of 1933, \$2,932,000. Mexico, on the other hand, suffered heavy cuts in both volume and value. Coffee imports from that country, 37,237,000 pounds, were nearly 30 per cents less than in 1933 and their value, \$3,978,000, about 21 per cent less. The trade with the Central American countries held up much better, totaling 59,680,000 pounds, valued at \$5,814,000, as compared with 64,822,000 pounds, valued at \$5,858,000, in 1933. Considered as a unit this

000, as compared with 5,501,000 pounds valued at \$446,000 in 1933.

Imports of coffee from the East showed their tendency to fluctuate within wide limits. From the Netherlands East Indies we received 27,709,000 pounds, valued at \$2,347,000, more than twice as much as in the preceding year. The trade, however, is a highly uncertain one, as the following figures of imports into this country over the last six years will show: 1929, 27,953,000 pounds; 1930, 11,049,000 pounds; 1931, 10,672,000 pounds; 1932, 58,208,000 pounds; 1933, 11,537,000 pounds; 1934, 27,709,000 pounds. The import trade from Aden is more stable but much smaller. In 1934, it amounted to 2,295,000 pounds, a gain of 5.2 per cent over 1933, and was valued at \$290,000, a gain of 20.3 per cent.

COFFEE IMPORTS INTO THE U. S. FROM CENTRAL AMERICA

Calendar Year	Pounds	Value
1913	36,326,000	\$4,635,000
1914	44,897,000	5,466,000
1915	71,361,000	8,094,000
1916	111,259,000	12,776,000
1917	148,032,000	15,752,000
1918	195,260,000	19,234,000
1919	131,639,000	19,375,000
1920	159,204,000	30,389,000
1921	118,607,000	12,308,000
1922	99,173,000	11,779,000
1923	118,367,000	15,831,000
1924	95,542,000	15,551,000
1925	62,506,000	13,839,000
1926	89,388,000	20,148,000
1927	45,318,000	9,918,000
1928	60,820,000	12,913,000
1929	53,237,000	11,007,000
1930	57,990,000	8,491,000
1931	46,156,000	6,061,000
1932	48,719,000	4,949,000
1933	64,822,000	5,858,000
1934	59,680,000	5,814,000

Hawaii considerably increased its shipments of coffee to the mainland in 1934, supplying 5,468,000 pounds, valued at \$643,000, as against 4,158,000 pounds valued at \$536,000 in 1933. Puerto Rico is credited with shipments of 1,766,000 pounds valued at \$415,000 to continental United States, but this was practically all destined for foreign countries; 1,749,000 pounds were sent abroad and listed among exports of raw coffee from the United States. Coffee shipped from the mainland to these islands included 447,000 pounds of green and 524,000 pounds of roasted sent to Hawaii in 1934, and 39,000 pounds of roasted to Puerto Rico. Alaska also took 971,000 pounds of green and roasted coffee from continental United States, the value being \$248,000.

Central American area now ranks third on the list of sources of our coffee. The comparatively small trade with the West Indies was more than cut in half, amounting to 2,045,000 pounds, valued at \$212,-

Domestic exports of green coffee from the United States, including exports from Hawaii and Puerto Rico to foreign countries, totaled 6,842,000 pounds in 1934 and were valued at \$1,149,000. This compares

## RE-EXPORTS OF COFFEE FROM UNITED STATES, 1934

	1933 (pounds)	1934 (pounds)
(a) Total imports into U. S. ....	1,586,254,000	1,523,994,000
(b) Imports into non-contiguous territory from foreign countries.....	negligible	91,000
(c)—(a) minus (b) .....	1,586,254,000	1,523,903,000
(d) Total exports from U. S. ....	7,113,000	9,026,000
(e) Exports from non-contiguous territory .....	2,339,000	2,160,000
(f)—(d) minus (e) .....	4,774,000	6,866,000
(g) Total reexports from U. S. ....	12,447,000	10,192,000
(h) Reexports from non-contiguous territory .....	negligible	negligible
(i)—(g) minus (h) .....	12,447,000	10,192,000
(j) Imports into continental U. S. from non-contiguous territory .....	5,752,000	7,234,000
(k) Exports to non-contiguous territory from continental U. S. ....	1,668,000	1,942,000
(l)—(j) minus (k).....	4,084,000	5,292,000
Net consumption continental U. S.: (c) minus (f) minus (i) plus (l) ..	1,573,117,000	1,512,137,000
Population, official estimate, July 1 .....	125,693,000	126,425,000
Per capital consumption .....	12.52	11.96

with 5,634,000 pounds, valued at \$830,000, in 1933. Roasted coffee was sent abroad to the extent of 2,189,000 pounds, valued at \$505,000, as against 1933 shipments of 1,479,000 pounds valued at \$334,000, and extracts and substitutes to the extent of 875,000 pounds valued at \$547,000 as against 863,000 pounds valued at \$523,000 in 1933.

Re-exports of foreign coffee in 1934 were much heavier than domestic exports, totaling 10,192,000 pounds, valued at \$1,237,000. This was a decrease from the year before when this trade amounted to 12,477,000 pounds, valued at \$1,299,000. Most of this coffee went to Europe. The accompanying table shows the quantities re-exported to the chief purchasing countries in 1934.

With smaller net imports and the usual growth in population, the per capita coffee consumption of continental United States fell off about one-half pound from 1933. The 1934 per capita was 11.96 pounds as compared with 12.5 pounds in 1933 and 11.9 pounds in 1932. The accompanying

table shows the method followed in computing these per capita figures and the incoming and outgoing amounts for 1933 and 1934. The "non-contiguous territory" mentioned in the table includes Alaska, Hawaii, and Puerto Rico.

RE-EXPORTS OF FOREIGN COFFEE  
FROM THE U. S. IN 1934

Country of Destination	Pounds
Germany .....	2,945,000
France .....	2,183,000
Sweden .....	1,436,000
Netherlands .....	841,000
Belgium .....	338,000
Canada .....	323,000
Italy .....	307,000
Mexico .....	294,000
Denmark .....	283,000
Spain .....	192,000
Panama .....	170,000
Norway .....	155,000
Japan .....	131,000
Other countries .....	594,000
Total .....	10,192,000



**BOOK V**  
**SOCIAL ASPECTS**





## CHAPTER XXXIV

### WORLD'S COFFEE MANNERS AND CUSTOMS

HOW COFFEE IS ROASTED, PREPARED, AND SERVED IN ALL THE LEADING CIVILIZED COUNTRIES IN AFRICA, ASIA, EUROPE, AND NORTH AND SOUTH AMERICA—THE ARABIAN COFFEE CEREMONY—THE PRESENT-DAY COFFEE HOUSES OF TURKEY—TWENTIETH-CENTURY IMPROVEMENTS IN EUROPE AND THE UNITED STATES—COFFEE DRINKING IN AUSTRALASIA, CUBA, MARTINIQUE, PANAMA, AND THE PHILIPPINES

COFFEE manners and customs have shown little change in the Orient in the six hundred-odd years since the coffee drink was discovered by Sheik Omar in Arabia. As a beverage for western peoples, however, and more particularly in America, there have been many improvements in making and serving it.

A brief survey of the coffee conventions and coffee service in the principal countries where coffee has become a fixed item in the dietary is presented here, showing how different peoples have adapted the universal drink to their national needs and preferences.

To proceed in alphabetical order, and beginning with Africa, coffee drinking is indulged in largely in Abyssinia, Algeria, Egypt, Portuguese East Africa, and the Union of South Africa.

#### *Coffee Manners and Customs in Africa*

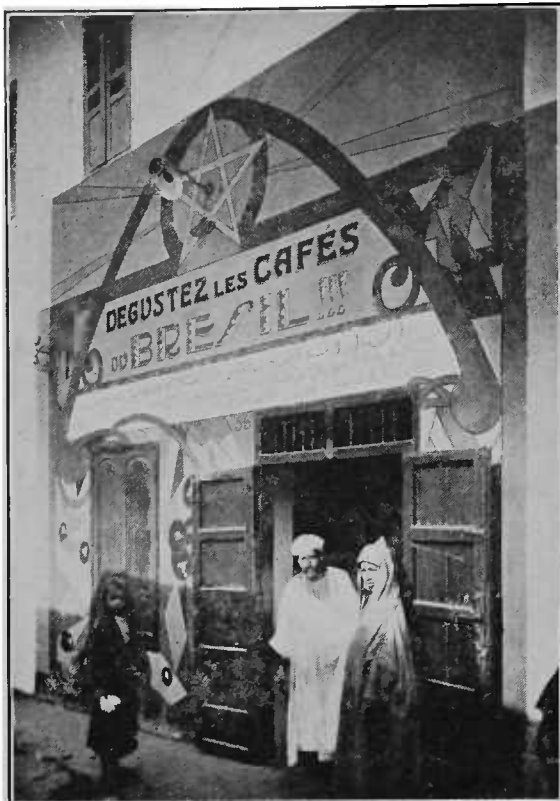
In Abyssinia and Somaliland, among the native population, the most primitive methods of coffee making still obtain. Here the wandering Galla still mix their pulverized coffee beans with fats as a food ration, and others of the native tribes favor the *kisher*, or beverage made from the toasted coffee hulls. An hour's boiling produces a straw-colored decoction, of a slightly sweetish taste. Where the Arabian customs have taken root, the drink is prepared from the roasted beans after the Arabian and Turkish method. The white inhabitants usually prepare and serve the

beverage as in the homeland; so that it is possible to obtain it after the English, French, German, Greek, or Italian styles. Adaptations of the French sidewalk café, and of the Turkish coffee house, may be seen in the larger towns.

In the equatorial provinces of Egypt, and in Uganda, the natives eat the raw berries; or first cook them in boiling water, dry them in the sun, and then eat them. It is a custom to exchange coffee beans in friendly greeting.

Individual earthen vessels for making coffee, painted red and yellow, are made by some of the native tribes in Abyssinia, and usually accompany disciples of Islam when they journey to Mecca, where the vessels find a ready sale among the pilgrims, most of whom are coffee-devotees.

Turkish and Arabian coffee customs prevail in Algeria and Egypt, modified to some extent by European contact. The Moorish cafés of Cairo, Tunis, and Algiers have furnished inspiration and copy for writers, artists, and travelers for several centuries. They change little with the years. The *mazagran*—sweetened cold coffee to which water or ice has been added—originated in Algeria. It probably took its name from the fortress of the same name reserved to France by the treaty of the Tafna in 1837. It is said that the French colonial troops were first served with a drink made from coffee syrup and cold water on marches near Mazagran, formerly spelled Masagran. Upon their return to the French capital, they introduced the



BRAZIL COFFEE SHOP IN CASABLANCA, MOROCCO

idea, with the added fillip of service in tall glasses, in their favorite cafés, where it became known as *café mazagran*. Variants are coffee syrup with seltzer, and with hot water. "This fashion of serving coffee in glasses," says Jardin, "has no *raison d'être*, and nothing can justify abandoning the cup for coffee."

In the principal streets and public squares of any town in Algeria it is a common sight to find a group of Arabs squatting about a portable stove and a table on which cups are in readiness to receive the boiling coffee. The thirsty Arab approaches the dealer, and for a modest sum he gets his drink and goes his way; unless he prefers to go inside the café, where he may get several drinks and linger over them, sitting on a mat with his legs crossed and smoking his *chibouque*. Indeed, this is a typical scene throughout the Near East, where sheds or coffee tents—sketches of the more pretentious coffee houses—coffee shops, and itinerant coffee-venders are to be met at almost every turn.

In an unpublished work, Baron Antoine Rousseau and Th. Roland de Bussy have the following description of a typical Moorish café at Algiers:

We entered without ceremony into a narrow deep cave, decorated with the name of the café. On the right and on the left, along its length, were two benches covered with mats; notched cups, tongs, a box of brown sugar, all placed near a small stove, completed the furniture of the place. In the evening, the dim light from a lamp hanging from the ceiling shows the indistinct figures of a double row of natives listening to the nasal cadences of a band who play a pizzicato accompaniment on small three-stringed violins.

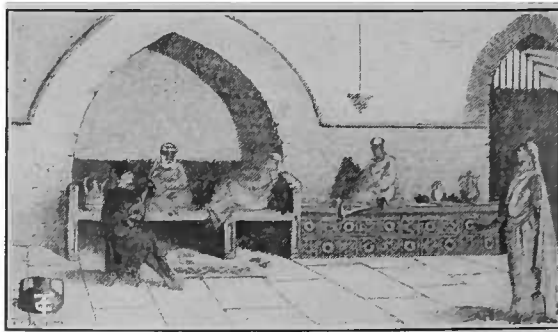
Here, as in Europe, the cafés are the providential rendezvous for idlers and gossips, exchanges for real-estate brokers and players at cards.

Europeans recently arrived frequent them particularly. Some go only to satisfy their curiosity; others out of an inborn scorn for the customs of civilization. They go to sleep as Frenchmen, they awake Mohammedans! Their love for "Turkish art" only leads them to haunt the native shops and to affect oriental poses.

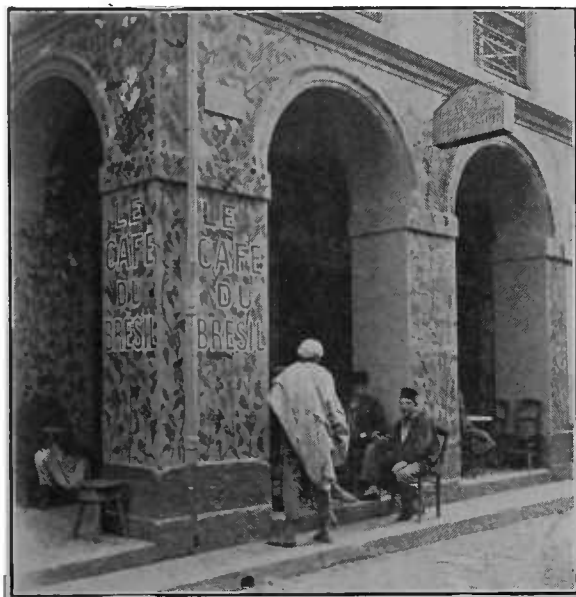
If we quit for a moment the interior of the city to follow between two hedgerows of mastic or aloes, one of those capricious paths which lead one, now up to the summit of a hill, now to the depths of some ravine, very soon the tones of a rustic flute, the modulations of the *Djouwak*, will betray some cool and peaceful retreat, some rustic café, easily recognized by its facade, pierced with large openings. To my eyes, nothing equals the charm of these little buildings scattered here and there along the edges of a stream, sheltered under the thick foliage, and constantly enlivened by the coming and going of the husbandmen of the neighborhood.

Certain old Moors from the neighboring districts, fleeing the noises of the city, are the faithful habitués of these agreeable retreats. Here they install themselves at dawn, and know how to enjoy every moment of their day with tales of their travels and youthful adventures, and many a legend for which their imagination takes all the responsibility.

Gérôme's painting of the "Coffee House at Cairo," which hangs in the Metropolitan Museum of Art, New York, gives one a good idea of the atmosphere of the Egyptian café. The preparation and service is modified Turkish-Arabian. The coffee is ground to a powder, boiled in an *ibrik* with



MOORISH COFFEE HOUSE IN ALGIERS



BRAZIL CAFÉ AT ALGIERS, WITH WALL PAINTINGS OF COFFEE BRANCHES, FRUIT, AND FLOWERS

the addition of sugar, and served frothing in small cups. Story-tellers, singers, and dancers furnish amusement as of yore. The Oriental customs have not changed much in this respect. Trolley cars, victorias, and taxis may have replaced the donkeys in the new sections of the larger Egyptian cities; but in old Alexandria and Cairo, the approach to the native coffee house is as dirty and as odorous as ever. Coffee is always served in all business transactions. Nowadays, the Egyptian women chew gum and the men smoke cigarettes, French department stores offer bargain sales and the hotels advertise tea dances; but the Egyptian coffee drink is still the tiny cup of coffee grounds and sugar that it was three hundred years ago, when sugar was first used to sweeten coffee in Cairo.

In Portuguese East Africa, the natives prepare and drink coffee after the approved African native fashion, but the white population follows European customs. In the Union of South Africa, Dutch and English customs prevail in making and serving the beverage.

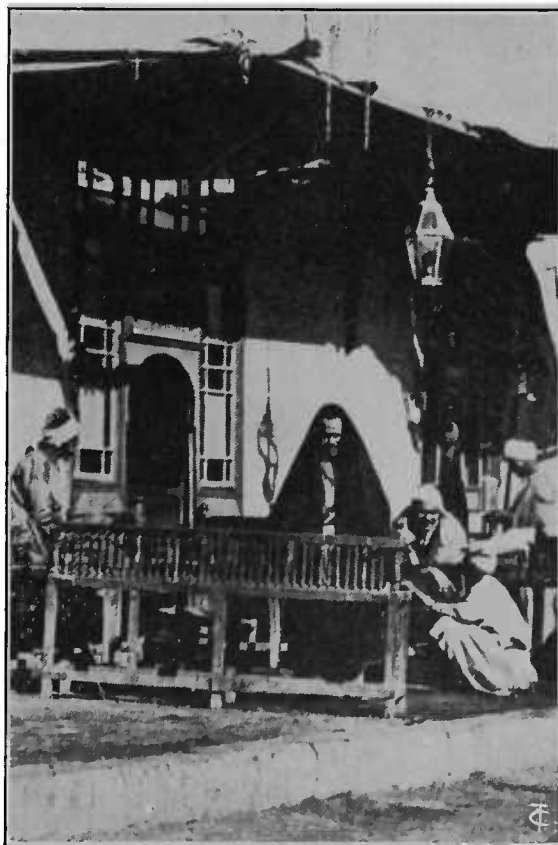
#### *Manners and Customs in Asia*

"Arabia the Happy" deserves to be called "the Blest," if only for its gift of coffee to the world. Here it was that the virtues of the drink were first made known; here the plant first received inten-

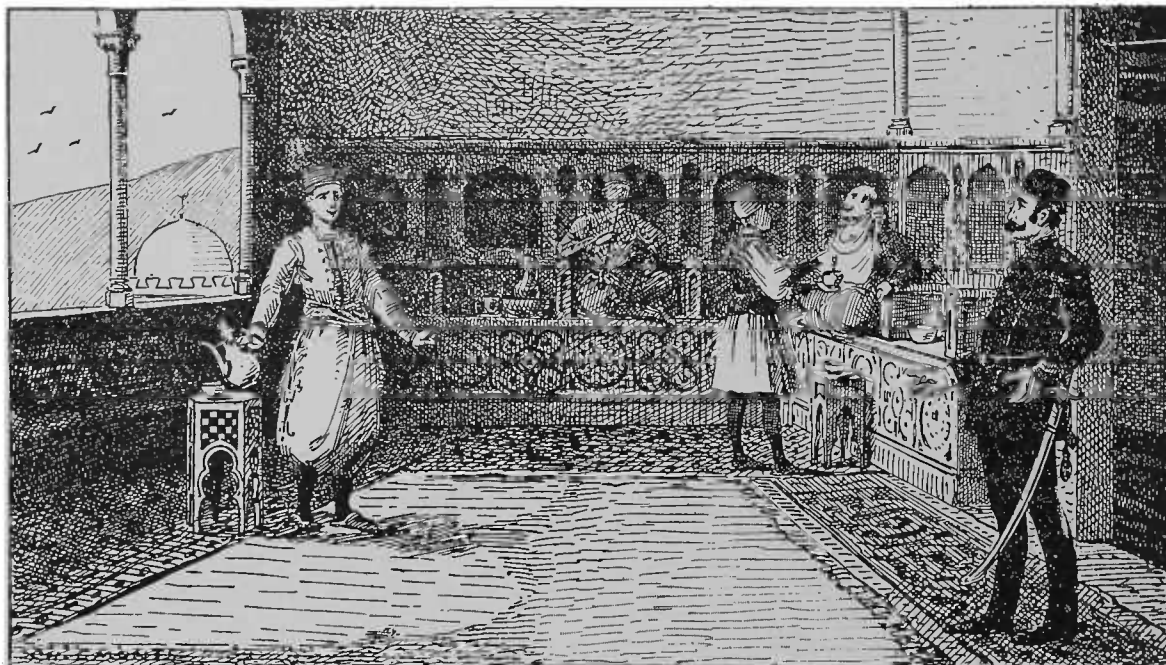
sive cultivation. After centuries of habitual use of the beverage, we find the Arabs, now as then, one of the strongest and noblest races of the world, mentally superior to most of them, generally healthy, and growing old so gracefully that the faculties of the mind seldom give way sooner than those of the body. They are an ever living earnest of the healthfulness of coffee.

The Arabs are proverbially hospitable; and the symbol of their hospitality for a thousand years has been the great drink of democracy—coffee. Their very houses are built around the cup of human brotherhood. William Wallace, writing on Arabian philosophy, manners, and customs, says:

The principal feature of an Arab house is the *kahwah* or coffee room. It is a large apartment spread with mats, and sometimes furnished with carpets and a few cushions. At one end is a small furnace or fireplace for preparing coffee. In this room the men congregate; here guests are received, and even lodged; women rarely enter it, except at times when strangers are unlikely to be present. Some of these apartments are very spacious and supported by



COFFEE HOUSE IN CAIRO



COFFEE SERVICE AT A BARBER SHOP IN CAIRO

pillars; one wall is usually built transversely to the compass direction of the *Ka'ba* (sacred shrine of Mecca). It serves to facilitate the performance of prayer by those who may happen to be in the *kahwah* at the appointed times.<sup>1</sup>

Several rounds of coffee, without milk or sugar, but sometimes flavored with cardamom seeds, are served to the guest at first welcome; and coffee may be had at all hours between meals, or whenever the occasion demands it. Always the beans are freshly roasted, pounded, and boiled. The Arabs average twenty-five to thirty cups (*fin-djans*) a day. Everywhere in Arabia there are to be found cafés where the beverage may be bought.

Those of the lower classes are thronged throughout the day. In front, there is generally a porch or bench where one may sit. The rooms, benches, and little chairs lack the cleanliness and elegance of the one-time luxurious "*caffinets*" of cities like Damascus and Constantinople, but the drink is the same. There is not in all Yemen a single market town or hamlet where one does not find upon some simple hut the legend, "Shed for drinking coffee."

The Arab drinks water before taking coffee, but never after it. "Once in Syria," says a traveler, "I was recognized as a

foreigner because I asked for water just after I had taken my coffee. 'If you belonged here, said the waiter, 'you would not spoil the taste of coffee in your mouth by washing it away with water.'"

It is an adventure to partake of coffee prepared in the open, at a roadside inn, or khan, in Arabia by an *araba*, or diligence driver. He takes from his saddle-bag the ever-present coffee kit, containing his supply of green beans, of which he roasts just sufficient on a little perforated iron plate over an open fire, deftly taking off the beans, one at a time, as they turn the right color. Then he pounds them in a mortar, boils his water in the long, straight-handled open boiler, or *ibrik* (a sort of brass mug or *jezveh*), tosses in the coffee powder, moving the vessel back and forth from the fire as it boils up to the rim; and, after repeating this maneuver three times, pours the contents foaming merrily into the little egg-like serving cups.

*Café sultan*, or *kisher*, the original decoction, made from dried and toasted coffee hulls, is still being drunk in parts of Arabia and Turkey.

Coffee in Arabia is part of the ritual of business, as in other Oriental countries. Shop-keepers serve it to the customer before the argument starts. Once a New York barber got some valuable publicity because he regaled his customers with tea

<sup>1</sup> *Encyclopedia Britannica*, 11th Ed. (vol. 11: p. 285).



and music. It was "old stuff." The Arabian and Turkish barber shops have been serving coffee, tobacco, and sweetmeats to their customers for centuries.

For a faithful description of the ancient coffee ceremony of the Arabs, which, with slight modification, is still observed in Arabian homes, we turn to Palgrave. First he describes the dwelling and then the ceremony:

The K'hawah was a large oblong hall, about twenty feet in height, fifty in length, and sixteen, or thereabouts, in breadth; the walls were coloured in a rudely decorative manner with brown and white wash, and sunk here and there into small triangular recesses, destined to the reception of books, though of these Ghafil at least had no over-abundance, lamps, and other such like objects. The roof of timber, and flat; the floor was strewed with fine clean sand, and garnished all around alongside of the walls with long strips of carpet, upon which cushions, covered with faded silk, were disposed at suitable intervals. In poorer houses felt rugs usually take the place of carpets.

In one corner, namely, that furthest removed from the door, stood a small fireplace, or, to speak more exactly, furnace, formed of a large square block of granite, or some other hard stone, about twenty inches each way; this is hollowed inwardly into a deep funnel, open above, and communicating below with a small horizontal tube or pipe-hole, through which the air passes, bellows-driven, to the lighted charcoal piled up on a grating about half-way inside the cone. In this manner the fuel is soon brought

to a white heat, and the water in the coffee-pot placed upon the funnel's mouth is readily brought to boil. The system of coffee furnaces is universal in Djowf and Djebel Shomer, but in Nejed itself, and indeed in whatever other yet more distant regions of Arabia I visited to the south and east, the furnace is replaced by an open fireplace hollowed in the ground floor, with a raised stone border, and dog-irons for the fuel, and so forth, like what may be yet seen in Spain. This diversity of arrangement, so far as Arabia is concerned, is due to the greater abundance of fire-wood in the south, whereby the inhabitants are enabled to light up on a larger scale; whereas throughout the Djowf and Djebel Shomer wood is very scarce, and the only fuel at hand is bad charcoal, often brought from a considerable distance, and carefully husbanded.

This corner of the K'hawah is also the place of distinction whence honour and coffee radiate by progressive degrees round the apartment, and hereabouts accordingly sits the master of the house himself, or the guests whom he more especially delighteth to honour.

On the broad edge of the furnace or fireplace, as the case may be, stands an ostentatious range of copper coffee-pots, varying in size and form. Here in the Djowf their make resembles that in vogue at Damascus; but in Nejed and the eastern districts they are of a different and much more ornamental fashioning, very tall and slender, with several ornamental circles and mouldings in elegant relief, besides boasting long beak-shaped spouts and high steeples for covers. The number of these utensils is often extravagantly great. I have seen a dozen at a time in a row by one fireside, though coffee-making requires, in fact, only three at most. Here in the Djowf five or six are considered to be the thing; for



BREWING THE GUEST'S COFFEE IN A MOHAMMEDAN HOME



SHIPS OF THE DESERT LADEN WITH COFFEE,  
ARABIA

the south this number must be doubled; all this to indicate the riches and munificence of their owner, by implying the frequency of his guests and the large amount of coffee that he is in consequence obliged to have made for them.

Behind this stove sits, at least in wealthy houses, a black slave, whose name is generally a diminutive in token of familiarity or affection; in the present case it was Soweylim, the diminutive of Sālim. His occupation is to make and pour out the coffee; where there is no slave in the family, the master of the premises himself, or perhaps one of his sons, performs that hospitable duty; rather a tedious one, as we shall soon see.

We enter. On passing the threshold it is proper to say, "*Bismillah*," i.e., "in the name of God"; not to do so would be looked on as a bad augury alike for him who enters and for those within. The visitor next advances in silence, till on coming about half-way across the room, he gives to all present, but looking specially at the master of the house, the customary "*Es-salamu'aleykum*," or "Peace be with you," literally, "on you." All this while every one else in the room has kept his place, motionless, and without saying a word. But on receiving the salaam of etiquette, the master of the house rises, and if a strict Wahhābee, or at any rate desirous of seeming such, replies with the full-length traditional formula. "*W' 'aleykumu-s-salamu, w'rahmat' Ullahi w'barakātuh*," which is, as every one knows, "And with (or, on) you be peace, and the mercy of God, and his blessings." But should he happen to be of anti-Wahhābee tendencies the odds are that he will say "*Marhab'i*," or "*Ahlan w' sahlān*," i.e., "welcome" or "worthy, and pleasurable," or the like; for of such phrases there is an infinite, but elegant variety.

All present follow the example thus given, by rising and saluting. The guest then goes up to the master of the house, who has also made a step or two forwards, and places his open hand in the palm of his host's, but without grasping or shaking, which would hardly pass for decorous, and at the same time each repeats once more his greeting, followed by the set phrases of polite enquiry, "How are you?" "How goes the world with you?" and so forth, all in a tone of great interest, and to be gone over three or four times, till one or other has the discretion to say "*El hamdu l'illah*," "Praise be to God," or, in equivalent value, "all right," and this is a

signal for a seasonable diversion to the ceremonious interrogatory.

The guest then, after a little contest of courtesy, takes his seat in the honoured post by the fireplace, after an apologetical salutation to the black slave on the one side, and to his nearest neighbour on the other. The best cushions and newest looking carpets have been of course prepared for his honoured weight. Shoes or sandals, for in truth the latter alone are used in Arabia, are slipped off on the sand just before reaching the carpet, and there they remain on the floor close by. But the riding stick or wand, the inseparable companion of every true Arab, whether Bedouin or townsman, rich or poor, gentle or simple, is to be retained in the hand, and will serve for playing with during the pauses of conversation, like the fan of our great-grandmothers in their days of conquest.

Without delay Soweylim begins his preparations for coffee. These open by about five minutes of blowing with the bellows and arranging the charcoal till a sufficient heat has been produced. Next he places the largest of the coffee-pots, a huge machine, and about two-thirds full of clear water, close by the edge of the glowing coal-pit, that its contents may become gradually warm while other operations are in progress. He then takes a dirty knotted rag out of a niche in the wall close by, and having untied it, empties out of it three or four hand-fuls of unroasted coffee, the which he places on a little trencher of platted grass, and picks carefully out any blackened grains, or other non-homologous substances, commonly to be found intermixed with the berries when purchased in gross; then, after much cleansing and shaking, he pours the grain so cleansed into a large open iron ladle, and places it over the mouth of the funnel, at the same time blowing the bellows and stirring the grains gently round and round till they crackle, redden, and smoke a little, but carefully withdrawing them from the heat long before they turn black or charred, after the erroneous fashion of Turkey and Europe; after which he puts them to cool a moment on the grass platter.

He then sets the warm water in the large coffee-pot over the fire aperture, that it may be ready boiling at the right moment, and draws in close between his own trouserless legs a large stone mortar, with a narrow pit in the middle,



AN ARABIAN COFFEE HOUSE

just enough to admit the large stone pestle of a foot long and an inch and a half thick, which he now takes in hand. Next, pouring the half-roasted berries into the mortar, he proceeds to pound them, striking right into the narrow hollow with wonderful dexterity, nor ever missing his blow till the beans are smashed, but not reduced into powder. He then scoops them out, now reduced to a sort of coarse reddish grit, very unlike the fine charcoal dust which passes in some countries for coffee, and out of which every particle of real aroma has long since been burnt or ground.

After all these operations, each performed with as intense a seriousness and deliberateness as if the welfare of the entire Djowf depended on it, he takes a smaller coffee-pot in hand, fills it more than half with hot water from the larger vessel, and then shaking the pounded coffee into it, sets it on the fire to boil, occasionally stirring it with a small stick as the water rises to check the ebullition and prevent overflowing. Nor is the boiling stage to be long or vehement; on the contrary, it is and should be as light as possible. In the interim he takes out of another rag-knot a few aromatic seeds called heyl, an Indian product, but of whose scientific name I regret to be wholly ignorant, or a little saffron, and after slightly pounding these ingredients, throws them into the simmering coffee to improve its flavour, for such an additional spicing is held indispensable in Arabia though often omitted elsewhere in the East. Sugar would be a totally unheard of profanation. Last of all, he strains off the liquor through some fibres of the inner palm-bark placed for that purpose in the jug-spout, and gets ready the tray of delicate parti-coloured grass, and the small coffee cups ready for pouring out. All these preliminaries have taken up a good half-hour.

Meantime we have become engaged in active conversation with our host and his friends. But our Sherarat guide, Suleyman, like a true Bedouin, feels too awkward when among town-folk to venture on the upper places, though repeatedly invited, and accordingly has squatted down on the sand near the entrance. Many of Ghāfil's relations are present; their silver-deco-

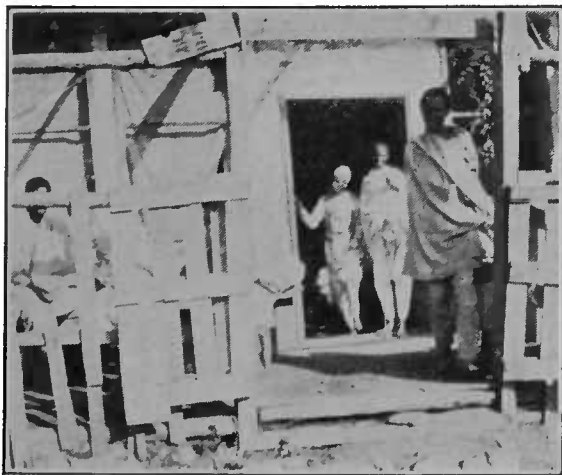


EARLY MANNER OF SERVING COFFEE, TEA, AND CHOCOLATE

From a drawing in Dufour's *Traitéz Nouveaux et Curieux du Café, du Thé et du Chocolat*

rated swords proclaim the importance of the family. Others, too, have come to receive us, for our arrival, announced before-hand by those we had met at the entrance pass, is a sort of event in the town; the dress of some betokens poverty, others are better class, but all have a very polite and decorous manner. Many a question is asked about our native land and town, that is to say, Syria and Damascus, conformably to the disguise already adopted, and which it was highly important to keep well up; then follow enquiries regarding our journey, our business, what we have brought with us, about our medicines, our goods and wares, etc., etc. From the very first it is easy for us to perceive that patients and purchasers are likely to abound. Very few travelling merchants, if any, visit the Djowf at this time of year, for one must be mad, or next door to it, to rush into the vast desert around during the heats of June and July; I for one have certainly no intention of doing it again. Hence we had small danger of competitors, and found the market almost at our absolute disposal.

But before a quarter of an hour has passed, and while blacky is still roasting or pounding his coffee, a tall thin lad, Ghāfil's eldest son, appears, charged with a large circular dish, grass-platted like the rest, and throws it with a graceful jerk on the sandy floor close before us. He then produces a large wooden bowl full of dates, bearing in the midst of the heap a cup full of melted butter; all this he places on the circular mat, and says, "*Semmo*," literally, "pronounce the Name," of God, understood; this means "set to work at it." Hereon the master of the house quits his place by the fireside and seats himself



NATIVE CAFE, HARAR, ETHIOPIA

on the sand opposite to us; we draw nearer to the dish, and four or five others, after some respectful coyness, join the circle. Every one then picks out a date or two from the juicy half-amalgamated mass, dips them into the butter, and thus goes on eating till he has had enough, when he rises and washes his hands.

By this time the coffee is ready, and Soweylim begins his round, the coffee-pot in one hand; the tray and cups on the other. The first pouring out he must in etiquette drink himself, by way of a practical assurance that there is no "death in the pot"; the guests are next served, beginning with those next the honourable fireside; the master of the house receives his cup last of all. To refuse would be a positive and unpardonable insult; but one has not much to swallow at a time, for the coffee-cups, or finjans, are about the size of a large egg-shell at most, and are never more than half-filled. This is considered essential to good breeding, and a brimmer would here imply exactly the reverse of what it does in Europe; why it should be so I hardly know, unless perhaps the rareness of cup-stands or "zarfs" (see Lane's "Modern Egyptians") in Arabia, though these implements are universal in Egypt and Syria, might render an over-full cup inconveniently hot for the fingers that must grasp it without medium. Be that as it may, "fill the cup for your enemy" is an adage common to all, Bedouins or towns-



NUBIAN SLAVE GIRL WITH COFFEE SERVICE, PERSIA

men, throughout the Peninsula. The beverage itself is singularly aromatic and refreshing, a real tonic, and very different from the black mud sucked by the Levantine, or the watery roast-bean preparations of France. When the slave or freeman, according to circumstances, presents you with a cup, he never fails to accompany it with a "Semmi," "say the name of God," or must you take it without answering "Bismillah."

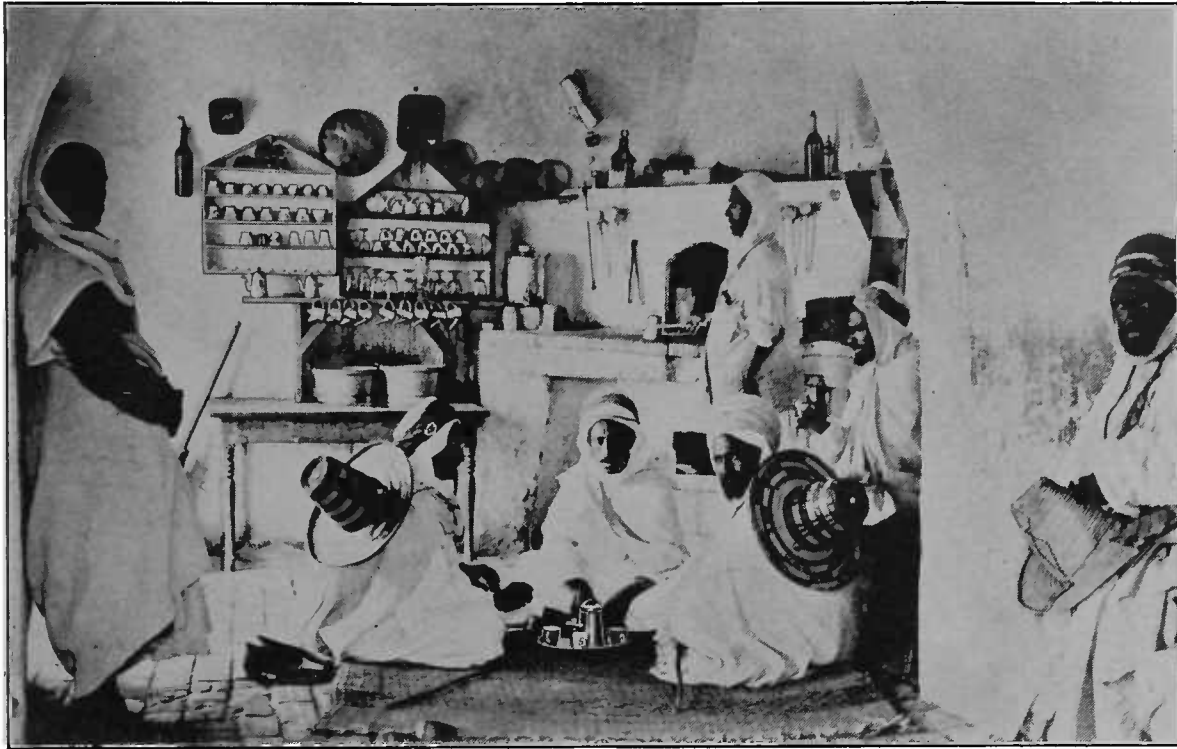
When all have been thus served, a second round is poured out, but in inverse order, for the host this time drinks first, and the guests last. On special occasions, a first reception, for instance, the ruddy liquor is a third time handed round; nay, a fourth cup is sometimes added. But all these put together do not come up to one-fourth of what a European imbibes in a single draught at breakfast.

For a more recent pen picture of coffee manners and customs in Arabia, we turn to Charles M. Daughy's *Travels in Arabia Deserta*:

Hirfa ever demanded of her husband towards which part should "the house" be built. "Dress the face," Zeyd would answer, "to this part," showing her with his hands the south, for if his booth's face be all day turned to the hot sun there will come in fewer young loitering and parasitical fellows that would be his coffee-drinkers. Since the *sheukh*, or heads, alone receive their tribes' *surra*, it is not much that they should be to the arms [of his] coffee-hosts. I have seen Zeyd avoid [them] as he saw them approach, or even rise ungraciously upon such men's presenting themselves (the half of every booth, namely the men's side, is at all times open, and any enter there that will, in the free desert), and they murmuring he tells them, *wallah*, his affairs do call him forth, adieu; he must away to the *mejlis*; go they and seek the coffee elsewhere. But were there any *sheykh* with them, a coffee lord, Zeyd could not honestly choose but abide and serve them with coffee; and if he be absent himself, yet any *sheykhly* man coming to a *sheykh's* tent, coffee must be made for him, except he gently protest "*billah*, he would not drink." Hirfa, a *sheykh's* daughter and his high kinswoman, was a faithful mate to Zeyd in all his sparing policy.

Our *menzil* now standing, the men step over to Zeyd's coffee-fire, if the *Sheykh* be not gone forth to the *mejlis* to drink his mid-day cup there. A few gathered sticks are flung down beside the hearth; with flint and steel one stoops and strikes fire in tinder, he blows and cherishes those seeds of the cheerful flame in some dry camel-dung, sets the burning shred under dry straws, and powders over more dry camel-dung. As the fire kindles, the *sheykh* reaches for his *dellal*, coffee-pots, which are carried in the *fatya*, coffee-gear basket; this people of a nomad life bestow each thing of theirs in a proper *beyt*; it would otherwise be lost in their daily removings. One rises to go to fill up the pots at the water-skins, or a bowl of water is handed over the curtain from the woman's side; the pot at the fire, Hirfa reaches over her little palm-ful of green coffee berries. These are roasted and brayed; as all is boiling he sets out his little cups, *fenjeyl* (for *fenjeyn*). When, with a pleas-





INTERIOR OF AN ARABIAN COFFEE SHOP, ALGIERS

ant gravity, he has unbuckled his *gutia* or cup-box, we see the nomad has not above three or four *fenjeyns*, wrapt in a rusty clout, with which he scours them busily, as if this should make his cups clean. The roasted beans are pounded amongst Arabs with a magnanimous rattle—and (as all their labor) rhythmical—in brass of the town, or an old wooden mortar, gaily studded with nails, the work of some nomad smith. The water bubbling in the small *dellal*, he casts in his fine coffee powder, *el-bunn*, and withdraws the pot to simmer a moment. From a knot in his kerchief he takes then a head of cloves, a piece of cinnamon or other spice, *bahar*, and braying these he casts their dust in after. Soon he pours out some hot drops to essay his coffee; if the taste be to his liking, making dexterously a nest of all the cups in his hand, with pleasant clattering, he is ready to pour out for all the company, and begins upon his right hand; and first, if such be present, to any considerable *sheykh* and principal persons. The *fenjeyn kah-wah* is but four sips; to fill it up to a guest, as in the northern towns, were among Bedouins an injury, and of such bitter meaning, "This drink thou and depart."

Then is often seen a contention in courtesy amongst them, especially in any greater assemblies, who shall drink first. Some man that receives the *fenjeyn* in his turn will not drink yet—he proffers it to one sitting in order under him, as to the more honourable; but the other putting off with his hand will answer *ebbeden*, "Nay, it shall never be, by Ullah! but do thou drink." Thus licensed, the humble man is despatched in three sips, and hands up his empty *fenjeyn*. But if he have much insisted, by this he opens his willingness to be reconciled with

one not his friend. That neighbor, seeing the company of coffee-drinkers watching him, may with an honest grace receive the cup, and let it seem not willingly; but an hard man will sometimes rebut the other's gentle proffer.

Some may have taken lower seats than becoming their *sheykhly* blood, of which the nomads are jealous; entering untimely, they sat down out of order, sooner than trouble all the company. A *sheykh*, coming late and any business going forward, will often sit far out in the assembly; and show himself a popular person in this kind of honourable humility. The more inward in the booth is the higher place; where also is, with the *sheykh*s, the seat of a stranger. To sit in the loose circuit without and before the tent, is for the common sort. A tribesman arriving presents himself at that part or a little lower, where in the eyes of all men his pretension will be well allowed; and in such observances of good nurture, is a nomad man's honour among his tribesmen. And this is nigh all that serves the nomad for a conscience, namely, that which men will hold of him. A poor person, approaching from behind, stands obscurely, wrapped in his tattered mantle, with grave ceremonial, until those sitting indolently before him in the sand shall vouchsafe to take notice of him; then they rise unwillingly, and giving back enlarge the coffee circle to receive him. But if there arrive a *sheykh*, a coffee-host, a richard amongst them of a few cattle, all the coxcomb companions within will hail him with their pleasant adulation *taad henneyi*, "Step thou up hither."

The astute *Fukara sheykh* surpass all men in their coffee-drinking courtesy, and Zeyd himself was more than any large of this gentlemen-like imposture: he was full of swaggering complacency



and compliments to an humbler person. With what suavity could he encourage, and gently too compel a man, and rising himself yield him parcel of another man's room! In such fashions Zeyd showed himself a bountiful great man, who indeed was the greatest niggard. The cups are drunk twice about, each one sipping after other's lips without misliking; to the great coffee *sheykhs* the cup may be filled more times, but this is an adulation of the coffee-server. There are some of the Fukara *sheukh* so delicate Sybarites that of those three bitter sips, to draw out all their joyance, twisting, turning, and tossing again the cup, they could make ten. The coffee-service ended, the grounds are poured out from the small into the great store-pot that is reserved full of warm water; with the bitter lye the nomads will make their next bever, and think they spare coffee.<sup>2</sup>

Here is an Arabian recipe for making



ROASTING COFFEE BEFORE A CAFÉ, TURKEY

coffee as given by Kadhi Hodhat, the best informed man of his time:

Tadj Eddin Aid Almaknab ben -Yacoub - Mekki Molki, chief of all the cantons of Hedjaz, (May God have mercy on him!) I learned it when once in his company at the time of the Holy Feasts. . He informed me that nothing is more beneficial than to drink cold water before coffee, because it lessens the dryness of the coffee and thus taken it does not cause insomnia to the same degree. The poet did not forget to explain this manner of taking coffee:

As with art 'tis prepared, one should drink it  
with art.  
The mere commonplace drinks one absorbs with  
free heart;  
But this—once with care from the bright flame  
removed,  
And the lime set aside that its value has proved—  
Take it first in deep draughts, meditative and  
slow,  
Quit it now, now resume, thus imbibe with gusto;  
While charming the palate it burns yet enchants,  
In the hour of its triumph the virtue it grants  
Penetrates every tissue; its powers condense,

<sup>2</sup> London; 1888 (vol. 1: pp. 222, 224).



IN A TURKISH COFFEE HOUSE

Circulate cheering warmths, bring new life to  
each sense.

From the cauldron profound spiced aromas unseen  
Mount to tease and delight your olfactories keen,  
The while you inhale with felicity fraught,  
The enchanting perfume that a zephyr has  
brought.<sup>3</sup>

Gone are the "luxurious and magnificent" coffee houses of Constantinople (if they ever existed—at least as we understand luxury and magnificence) which first brought the beverage world-wide fame;

<sup>3</sup> de Sacy. Baron Antoine Isaac Silvestre. *Chrestomathie Arabe*. Paris, 1806, (vol. 2).



PERSIAN COFFEE SERVICE, 1737



INTERIOR OF A TURKISH CAFFINET, EARLY NINETEENTH CENTURY.

such *caffinets* as the one pictured by Thomas Allom and described by the Rev. Robert Walsh, in *Constantinople, Illustrated*:

The *caffinet*, or coffee-house, is something more splendid, and the Turk expends all his notions of finery and elegance on this, his favorite place of indulgence. The edifice is generally decorated in a very gorgeous manner, supported on pillars, and open in front. It is surrounded on the inside by a raised platform, covered with mats or cushions, on which the Turks sit cross-legged. On one side are musicians, generally Greeks, with mandolins and tambourines, accompanying singers, whose melody consists in vociferation; and the loud and obstreperous concert forms a strong contrast to the stillness and taciturnity of Turkish meetings. On the opposite side are men, generally of a respectable class, some of whom are found here every day, and all day long, dozing under the double influence of coffee and tobacco. The coffee is served in very small cups, not larger than egg-cups, grounds and all, without cream or sugar, and so black, thick, and bitter that it has been aptly compared to "stewed soot." Besides the ordinary *chibouk* for tobacco, there is another implement, called *narghillai*, used for smoking in a *caffinet*, of a more elaborate construction. It consists of a glass vase, filled with water, and often scented with distilled rose or other flowers. This is surmounted with a silver or brazen head, from which issues a long flexible tube; a pipe-bowl is placed on the top, and so constructed that the smoke is drawn, and comes bubbling up through the water, cool and fragrant to the mouth. A peculiar kind

of tobacco, grown at Shiraz in Persia, and resembling small pieces of cut leather, is used with this instrument.

Certainly there never was any such thing as a coffee-house architecture. It may be that up to the time of Abdul Hamid, when money was more plentiful than it has been for the past fifty years, there were coffee houses more comfortably appointed than now exist.

The coffee house in a modernized form is, however, quite as numerous in Turkey as in the days of Amurath III and the notorious Kuprili.

H. G. Dwight, writing on the present-day Turkish coffee house, says:

There are thoroughfares in any Turkish city that carry on almost no other form of traffic. There is no quarter so miserable or so remote as to be without one or two. They are the clubs of the poorer classes. Men of a street, a trade, a province, or a nationality—for a Turkish coffee-house may also be Albanian, Armenian, Greek, Hebrew, Kurd, almost anything you please—meet regularly when their work is done, at coffee-houses kept by their own people. So much are the humbler coffee-houses frequented by a fixed clientèle that a student of types or dialects may realize for himself how truly they used to be called Schools of Knowledge.

The arrangement of a Turkish coffee-house is of the simplest. The essential is that the place should provide the beverage for which it exists



COFFEE MAKING IN TURKEY

and room for enjoying the same. A sketch of a coffee-shop may often be seen on the street, in a scrap of shade or sunshine according to the season, where a stool or two invite the passer-by to a moment of contemplation. Larger establishments, though they are rarely very large, are most often installed in a room longer than it is wide, having as many windows as possible at the street end and what we would call the bar at the other. It is a bar that always makes me regret I do not etch, with its pleasing curves, its high lights of brass and porcelain striking out of deep shadow, and its usually picturesque *kahvehji*.

You do not stand at it. You sit on one of the benches running down the sides of the room. They are more or less comfortably cushioned, though sometimes higher and broader than a foreigner finds to his taste. In that case you slip off your shoes, if you would do as the Romans do, and tuck your feet up under you. A table stands in front of you to hold your coffee—and often in summer an aromatic pot of basil to keep the flies away. Chairs or stools are scattered about. Decorative Arabic texts, sometimes wonderful prints, adorn the walls. There may even be hanging rugs and china to entertain your eyes. And there you are.

The habit of the coffee-house is one that requires a certain leisure. You must not bolt coffee as you bolt the fire-waters of the West, without ceremony, in retreats withdrawn from the public eye. Being a less violent and a less shameful passion, I suppose, it is indulged in with more of the humanities. The etiquette of the coffee-house, of those coffee-houses which have not been too much infected by Europe, is

one of their most characteristic features. Something like it prevails in Italy, where you tip your hat on entering and leaving a *caffè*. In Turkey, however, I have seen a new-comer salute one after another each person in a crowded coffee-room, once on entering the door and again after taking his seat, and be so saluted in return—either by putting the right hand to the heart and uttering the greeting *Merhabah*, or by making the *temennah*, that triple sweep of the hand which is the most graceful of salutes. I have also seen an entire company rise upon the entrance of an old man, and yield him the corner of honor.

Such courtesies take time. Then you must wait for your coffee to be made. To this end coffee, roasted fresh as required by turning in an iron cylinder over a fire of sticks and ground to the fineness of powder in a brass mill, is put into a small uncovered brass pot with a long handle. There it is boiled to a froth three times on a charcoal brazier, with or without sugar as you prefer. But to desecrate it by the admixture of milk is an unheard of sacrilege. Some *kahvehjis* replace the pot in the embers with a smart rap in order to settle the grounds. You in the meanwhile smoke. That also takes time, particularly if you “drink” a *narguileh*, as the Turks say. This is familiar enough in the West to require no great description. It is a big carafe with a metal top for holding tobacco and a long coil of leather tube for inhaling the water-cooled fumes thereof. The effect is wonderfully soothing



STREET COFFEE VENDER IN THE LEVANT, 1714

and innocent at first, though wonderfully deadly in the end to the novice. The tobacco used is not the ordinary weed, but a much coarser and stronger one called *tunbeki*, which comes from Persia. The same sort of tobacco used to be smoked a great deal in shallow red earthenware pipes with long mouthpieces. They are now chiefly seen in antiquity shops.

When your coffee is ready it is poured into an after-dinner coffee-cup or into a miniature bowl, and brought to you on a tray with a glass of water. A foreigner can almost always be spotted by the manner in which he finally partakes of these refreshments. A Turk sips his water first, partly to prepare the way for the coffee, but also because he is a connoisseur of the former liquid as other men are of stronger ones. And he lifts his coffee-cup by the saucer, whether it possess a handle or no, managing the two together in a dexterous way of his own. The current price for all this, not including the water-pipe, is ten paras—a trifle over a cent—for which the *kahvehji* will cry you "Blessing." More pretentious establishments charge twenty paras, while a giddy few rise to a piaster—not quite five cents



CAFETAN  
Oriental coffee-house keeper's costume

—or a piaster and a half. That, however, begins to look like extortion. And mark that you do not tip the waiter. I have often been surprised to be charged no more than the tariff, although I gave a larger piece to be changed and it was perfectly evident that I was a foreigner. That is an experience which rarely befalls a traveller among his own coreligionaries. It has even happened to me, which is rarer still, to be charged nothing at all, nay, to be steadfastly refused when I persisted in attempting to pay, simply because I was a foreigner, and therefore a guest.

There is no reason, however, why you should go away when you have had your coffee—or your glass of tea—and your smoke. On the contrary, there are reasons why you should stay, particularly if you happen into the coffee-house not too long after sunset. Then coffee-houses of the most local color are at their best. Earlier in the day their clients are likely to be at work. Later they will have disappeared altogether. For Constantinople has not quite forgotten the habits of the tent. Stamboul, except during the holy month of Ramazan, is a deserted city at night. But just after dark it is full of a life which an outsider is often content simply to watch through the lighted windows of coffee-rooms. There are also barber-shops, where men have shaved not only their chins, but different parts of their heads according to their "countries." In them likewise checkers, the Persian backgammon, and various games of long narrow cards are played. They say that Bridge came from Con-

stantinople. Indeed, I believe a club of Pera claims the honor of having communicated that passion to the Western World. But I must confess that I have yet to see an open hand in a coffee-house of the people.

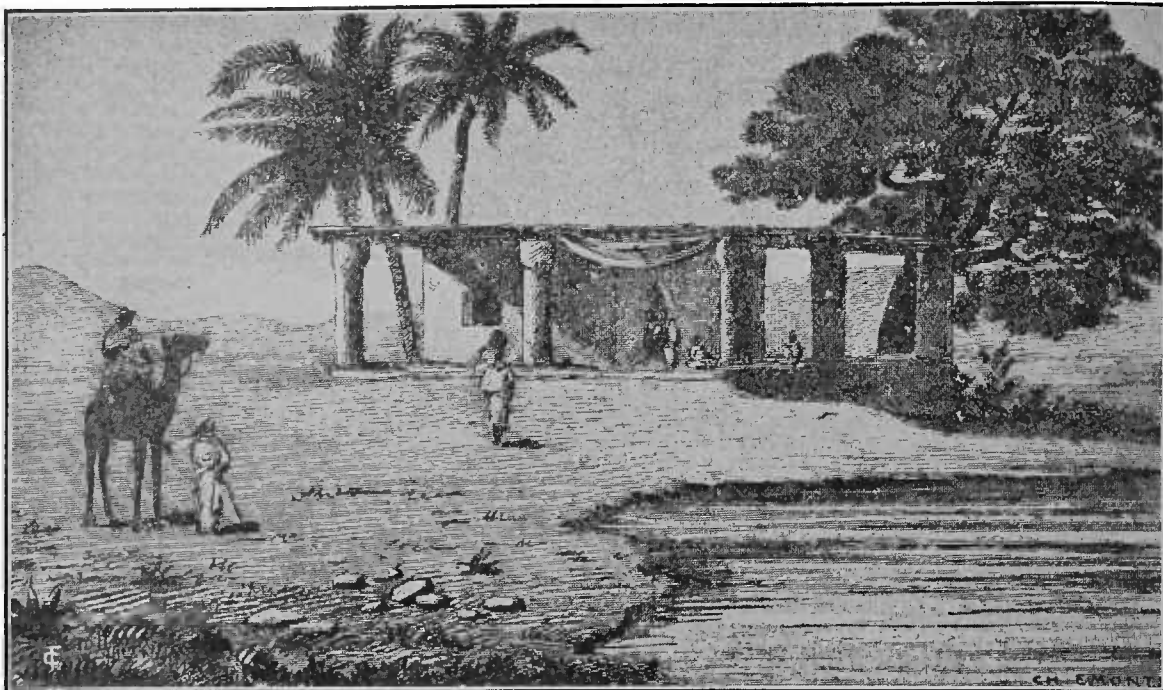
One of the pleasantest forms of amusement to be obtained in coffee-houses is unfortunately getting to be one of the rarest. It is that afforded by itinerant story-tellers, who still carry on in the East the tradition of the troubadours. The stories they tell are more or less on the order of the Arabian Nights, though perhaps even less suitable for mixed companies—which for the rest are never found in coffee-shops. These men are sometimes wonderfully clever at character monologue or dialogue. They collect their pay at a crucial moment of the action, refusing to continue until the audience has testified to the sincerity of its interest by some token more substantial.

Music is much more common. There are those, to be sure, who find no music in the sounds poured forth oftenest by a gramophone, often by a pair of gypsies with a flaring pipe and two small gourd drums, and sometimes by an orchestra so-called of the fine lute—a company of musicians on a raised dais who sing long songs while they play on stringed instruments of strange curves. For myself I know too little of music to tell what relation the recurrent cadences of those songs and their broken rhythms may bear to the antique modes. But I can listen, as long as musicians will perform, to those infinite



STREET COFFEE SERVICE IN CONSTANTINOPLE





A COFFEE HOUSE IN SYRIA—AFTER JARDIN

repetitions, that insistent sounding of the minor key. It pleases me to fancy there a music come from far away—from unknown river gorges, from camp-fires glimmering on great plains. Does not such darkness breathe through it, such melancholy, such haunting of elusive airs? There are flashes too of light, of song, the playing of shepherd's pipes, the swoop of horsemen and sudden outcries of savagery. But the note to which it all comes back is the monotone of a primitive life, like the day-long beat of camel bells. And more than all, it is the mood of Asia, so rarely penetrated, which is neither lightness or despair.

There are seasons in the year when these various forms of entertainment abound more than at others, as Ramazan and the two Bairams. Throughout the month of Ramazan the purely Turkish coffee-houses are closed in the daytime, since the pleasures which they minister may not then be indulged in; but they are open all night. It is during that one month of the year that Karaghieuz, the Turkish shadow-show, may be seen in a few of the larger coffee-shops. The Bairams are two festivals of three and four days respectively, the former of which celebrates the close of Ramazan, while the latter corresponds in certain respects to the Jewish Passover. Dancing is a particular feature of the coffee-houses in Bairam. The Kurds, who carry the burdens of Constantinople on their backs, are above all other men given to this form of exercise—though the Lazzes, the boatmen, vie with them. One of these dark tribesmen plays a little violin like a pochelle, or two of them perform on a pipe and a big drum, while the others dance round them in a circle, sometimes till they drop from fatigue. The weird music and the picturesque costumes and movements of the dancers make the spectacle one to be remembered.

Christian coffee-houses also have their own

festal seasons. These coincide in general with the festivals of the church. But every quarter has its patron saint, the saint of the local church or of the local holy well, whose feast is celebrated by a three-day *panayiri*. The street is dressed with flags and strings of colored paper, tables and chairs line the sidewalk, and libations are poured forth in honor of the holy person commemorated. For this reason, and because of the more volatile character of the Greek, the general note of his merrymaking is louder than that of the Turk. One may even see the scandalous spectacle of men and women dancing together at a Greek *panayiri*. The instrument which sets the key of these orgies is the *lanterna*, a species of hand-organ peculiar to Constantinople. It is a hand-piano rather, of a loud and cheerful voice, whose Eurasian harmonies are enlivened by a frequent clash of bells.

What first made coffee-houses suspicious to those in authority, however, is their true resource—the advantages they offer for meeting one's kind, for social converse and the contemplation of life. Hence it must be that they have so happy a tact for locality. They seek shade, pleasant corners, open squares, the prospect of water or wide landscapes. In Constantinople they enjoy an infinite choice of site, so huge is the extent of that city, so broken by hill and sea, so varied in its spectacle of life. The commonest type of city coffee-room looks out upon the passing world from under a grape-vine or a climbing wistaria.<sup>4</sup>

Coffee-houses of distinction are to be found also in the Place of the Pines over-

<sup>4</sup> *Scribner's Magazine*, 1913 (vol. lili: no. 5: p. 620); and Dwight. H. G., *Constantinople, Old and New*, New York, 1915. Copyright by Charles Scribner's Sons.



looking the Marble Sea, on Giant's Mountain, in the Landing Place of the Manslayer, and along the rivers that flow into the Golden Horn.

Originally the Turkish method of preparing coffee was the Arabian method, and it is so described by Mr. Fellows in his *Excursions through Asia Minor*:

Each cup is made separately, the little saucepan or ladle in which it is prepared being about an inch wide and two deep; this is more than half filled with coffee, finely pounded with a pestle and mortar, and then filled up with water; after being placed for a few seconds on the fire, the contents are poured, or rather shaken, out (being much thicker than chocolate) without the addition of cream or sugar, into a china cup of the size and shape of half an egg-shell, which is inclosed in one of ornamented metal for convenience of holding in the hand.

Later, the Turks sought to improve the method by adding sugar—a concession to the European sweet tooth—during the boiling process. The improved Turkish recipe is as follows:

First boil the water. For two cups of the beverage add three lumps of sugar and return the boiler to the fire. Add two teaspoonfuls of powdered coffee, stirring well and let the pot

boil up four times. Between each boiling the pot is to be removed from the fire and the bottom tapped gently until the froth on the top subsides. After the last boiling pour the coffee first into one cup and then the other, so as to evenly divide the froth.

In Syria and Palestine the Turkish-Arabian methods are followed. The brazen dippers, or *ibriks*, are used for boiling.

In the Near East, coffee manners and customs are much the same today as they were fifty or even one hundred years ago. Witness Damascus. The following pen picture of the cafés in this ancient city was written in 1836 to accompany the drawing by Bartlett and Purser, which is reproduced here; but it might have been written in 1935, so slight have been the changes in the setting or the spirit of the original coffee house that Shemsi first brought to Constantinople from Damascus in 1554.

The Cafés of the kind represented in the plate are, perhaps, the greatest luxury that a stranger finds in Damascus. Gardens, kiosques, fountains, and groves are abundant around every Eastern capital; but Cafés on the very bosom of a rapid river, and bathed by its waves, are peculiar to this ancient city; they are formed so as to exclude the rays of the sun, while they admit the



A RIVERSIDE CAFÉ IN DAMASCUS, NINETEENTH CENTURY  
After Bartlett and Purser

breeze; the light roof is supported by slender rows of pillars, and the building is quite open on every side.

A few of these houses are situated in the skirts of the town, on one of the streams, where the eye rests on the luxuriant vegetation of garden and wood; others are in the heart of the city; a flight of steps conducts to them from the sultry street, and it is delightful to pass in a few moments from the noisy, shadeless thoroughfare, where you see only mean gateways and the gable-ends of edifices, to a cool, grateful, calm place of rest and refreshment, where you can muse and meditate in ease and luxury, and feel at every moment the rich breeze from the river. In two or three instances, a light wooden bridge leads to the platform, close to which, and almost out of it, one or two large and noble trees lift the canopy of their spreading branches and leaves, more welcome at noon-day than the roofs of fretted gold in the "Arabian Nights." The high pavilion roof and the pillars are all constructed of wood; the floor is of wood, and sometimes of earth, and is regularly watered, and raised only a few inches above the level of the stream, which rushes by at the feet of the customer, which it almost bathes, as he sips his coffee or sherbet. Innumerable small seats cover the floor, and you take one of these, and place it in the position you like best.

Perhaps you wish to sit apart from the crowd, just under the shadow of the tree, or in some favourite corner where you can smoke, and contemplate the motley guests, formed into calm and solemn groups, who wish to hold no communion with the Giaour. There is ample food here for the observer of character, costume and pretension; the tradesman, the mechanic, the soldier, the gentleman, the dandy, the grave old man, looking wise on the past and dimly on the future; the hodge, in his green turban, vain of his journey to Mecca, and drawing a long bow in his tales and adventures: the long straight pipe, the hookah with its soft curling tube and glass vase, are in request: but the poorer argille is most commonly used.

From sunrise to set, these houses are never empty: we were accustomed to visit one of them early every morning, before breakfast, and very many persons were already there: yet this "balmy hour of prime" was the most silent and solitary of the whole day; it was the coolest also: the rising sun was glancing redly on the waters: there was as yet no heat in the air, and the little cup of Mocha coffee and the pipe were handed by an attendant as soon as the stranger was seated. His favourite Café was the one in the plate [page 531] the river is the Barrada, the ancient Pharpar. Never was the sound of many waters so pleasant to the ear as in Damascus: the air is filled with the sound, with which no clash of tongues, rolling of wheels, march of footman or horsemen, mingle: the numerous groups who love to resort here are silent half the time; and when they do converse, their voice is often "low, like that of a familiar spirit," or in short grave sentences that pass quickly from the ear.

Yet much, very much of the excitement of the life of the Turk in this city, is absorbed in these coffee-houses: they are his opera, his theatre, his conversazione: soon after his eyes are unclosed from sleep, he thinks of his Café, and forthwith

bends his way there: during the day he looks forward to pass the evening on the loved floor, to look on the waters, on the stars above, and on the faces of his friends; and at the moonlight falling on all. Mahomet committed a grievous error in the omission of coffee-houses in a future state: had he ever seen those of Damascus, he would surely have given them a place on his rivers of Paradise, persuaded that true believers must feel a melancholy void without them.

There is no ornament or richness about these houses: no sofas, mirrors, or drapery, save that afforded by a few evergreens and creepers: the famous silks and damasks of Damascus have no place here; all is plain and homely; yet no Parisian Café, with its beautiful mirrors, gilding, and luxuriousness, is so welcome to the imagination and senses of the traveller. After wandering many days over dry, and stony, and desert places, where the lip thirsted for the stream, is it not delicious to sit at the brink of a wild, impetuous torrent, to gaze on its white foam and breaking waves, till you can almost feel their gush in every nerve and fibre, and can bathe your very soul in them. And while you slowly smoke your pipe of purest tobacco, the sands of the desert, and their burning sun, rise again before you, when you prayed for even the shadow of a cloud on your way. The banks are in some parts covered with wood, whose soft green verdure contrasts beautifully with the clear torrent, and almost droops into its bosom.

Near the coffee-houses are one or two cataracts several feet high, and the perpetual sound of their fall, and the coolness they spread around, are exquisite luxuries—in the heat of day, or in the dimness of evening. There are two or three Cafés constructed somewhat differently from those just described: a low gallery divides the platform from the tide; fountains play on the floor, which is furnished with very plain sofas and cushions; and music and dancing always abound, of the most unrefined description.

The only intellectual gratification in these places is afforded by the Arab story-tellers, among whom are a few eminent and clever men: soon after his entrance, a group begins to form around the gifted man, who, after a suitable pause, to collect hearers or whet their expectations, begins his story. It is a picturesque sight—of the Arab with his wild and graceful gestures, and his auditory, hushed into deep and child-like attention, seated at the edge of the rushing tide, while the narrator moves from side to side, and each accent of his distinct and musical voice is heard throughout the Café. The building directly opposite is another house, of a similar kind in every respect. There are a few small Cafés, more select as to company, where the Turkish gentlemen often go, form dinner parties, and spend the day.

Night is the propitious season to visit these places: the glare of the sun, glancing on the waters, is passed away; the company is then most numerous, for it is their favourite hour; the lamps, suspended from the slender pillars, are lighted; the Turks, in the various and brilliant colours of their costume, crowd the platform, some standing moveless as the pillars beside them, their long pipe in their hand—noble specimens of humanity, if intellect breathed within: some reclining against the rails, others seated



COFFEE AL FRESCO IN JERUSALEM

in groups, or solitary as if buried in "lonely thoughts sublime"; while the rush of the falling waters is sweeter music than that of the pipe and the guitar, that faintly strive to be heard. The cataract in the plate is a very fine one; on its foam the moonlight was lovely: we passed many an hour here on such a night, the clear waters of the Pharpar, as they rolled on, reflecting each pillar, each Damascene slowly moving by in his waving garments. The glare of the lamps mingled strangely with the moonlight, that rested with a soft and vivid glory on the waters, and fell beneath pillar and roof on the picturesque groups within.<sup>5</sup>

The slender brass coffee grinders sometimes serve as a combination utensil in the equipment of the Turkish officer. Frequently they are made of silver. They might be called collapsible, convertible coffee kits, as they are made to serve as a combination coffee pot, mill, can, and cup. The green or roasted beans are kept in the lower section. It takes but a minute to unscrew the apparatus. To make a cup of coffee, the beans are dumped out and three or four of them are put in the middle section. The steel crank is fitted over the squared rod projecting from the middle section, which revolves, setting in motion

the grinding apparatus inside. The ground coffee falls into the bottom section, and water is added. The pot is placed on the fire, and the contents brought to a boil. The coffee pot serves as a cup. The process requires but a few minutes. The cup is rinsed out, the beans replaced, the utensils put together, the whole thing is slipped into the officer's tunic, and he goes on, refreshed.

In Iran, where tea is mostly drunk, the Turkish-Arabian methods of making coffee are followed. In Ceylon and India, the same applies to the native population, but the whites follow the European practice. In India, many people look upon coffee as just a *bonne bouche*—a "chaser." A well known English tea firm, has had some success in India with a tinned "French coffee," which is a blend of Indian coffee and chicory.

European methods obtain in making coffee in China and Japan, and in the French and Dutch colonies. When traveling in the Far East one of the greatest hardships the coffee lover is called upon to endure is the European bottled coffee extract, which so often supplies lazy chefs with the makings of a most forbidding cup of coffee.

<sup>5</sup> Carne, John. *Syria, the Holy Land*. London, 1836 (p. 69).



Photograph by Burton Holmes  
THE CAFE SCHRANGL IN THE GRABEN, VIENNA, BEFORE THE WORLD WAR

In Java, a favorite method is to make a strong extract by the French drip process and then to use a spoonful of the extract to a cup of hot milk—a good drink when the extract is freshly made for each service.

#### *Coffee Making in Europe*

In Europe, the coffee drink was first sold by lemonade venders. In Florence those who sold coffee, chocolate, and other beverages were not called *caffetiéri* (coffee sellers) but *limonáji* (lemonade venders). Pascal's first Paris coffee shop served other drinks as well as coffee; and Procope's café began as a lemonade shop. It was only when coffee, which was an afterthought, began to lead the other beverages, that he gave the name café to his whole refreshment place.

Today, nearly every country in Europe can supply the two extremes of coffee making. In Paris and Vienna, one may find it brewed and served in its highest perfection; but here too it is frequently found as badly done as in England, and that is saying a good deal. The principal difficulty seems to be in the chicory flavor, for which long years of use has cultivated a taste, with most people. Now coffee-and-chicory is not at all a bad drink; indeed

the author confesses to have developed a certain liking for it after a time in France—but it is not coffee. In Europe, chicory is not regarded as an adulterant—it is an addition, or modifier, if you please. And so many people have acquired a coffee-and-chicory taste, that it is doubtful if they would appreciate a real cup of coffee should they ever meet it. This, of course, is a generalization; and like all generalizations, is dangerous, for it is possible to obtain good coffee, properly made, in any European country, even England, in the homes of the people, but seldom in the hotels or restaurants.

**AUSTRIA.** Coffee is made in Austria after the French style, usually by the drip method or in the pumping percolator device, commonly called the Vienna coffee machine. The restaurants employ a large-size urn fitted with a combination metal sieve and cloth sack. After the ground coffee has infused for about six minutes, a screw device raises the metal sieve, the pressure forcing the liquid through the cloth sack containing the ground coffee.

Vienna cafés are famous, but the World War dimmed their glory. It used to be said that their equal could not be found for general excellence and moderate prices. From half-past eight to ten in the morn-



ing, large numbers of people were wont to breakfast in them on a cup of coffee or tea, with a roll and butter. *Mélangé* is with milk; "brown" coffee is darker and a *schwarzer* is without milk. In all the cafés the visitor may obtain coffee, tea, liqueurs, ices, bottled beer, ham, eggs, etc. The Café Schrangl in the Graben is typical. Then there are the dairies, with coffee, a unique institution. In the *Prater* (public park) there are many interesting cafés.

Charles J. Rosebault, writing in the *New York Times*, once said:

The Café of Vienna has been imitated all over the world—but the result has never failed to be an imitation. The nearest approach to the genuine in my experience was the upstairs room of the old Fleischmann Café in New York. That was because the average New Yorker knew it not and it remained sacred to the internationalists: the musicians, artists, writers, and other Bohemians to whom had been intrusted the secret of its existence. It is the spirit that counts, and it was the spirit of its frequenters that made the Vienna café. It was everyman's club, and everywoman's, too, where one went to relax and forget all the worries of existence, to look over papers and magazines from all parts of the world and printed in every known language, to play chess or skat or taracq, to chat with friends and to drink the inimitable Viennese coffee, the fragrance of which can no more be described than the perfume of last year's violets.

The café was filled after the noon meal, when busy men took their coffee and smoked; again around five o'clock, when all the world and his wife paraded along the Graben and the Karntner Strasse, and then dropped into a favorite café for coffee or chocolate and cakes—horns and crescents of delicious dough filled with jam or, possibly, the wonderful Kugelhupf, in comparison with which our sponge is like unto lead; finally in the evening, when there were family parties and those returning from theatres and concerts and opera.

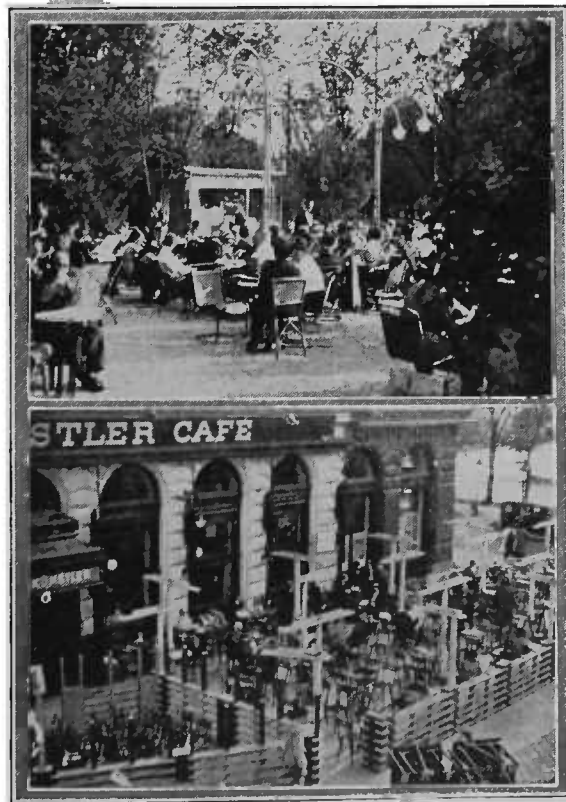
While the café life of Vienna was nearly killed by the World War, time has restored at least something of its former glory. We read that Oscar Straus, composer of *The Chocolate Soldier*, is living in comparative luxury in Vienna, and spends most of his time in the cafés, where he is to be found usually from two until five in the afternoon and from eleven o'clock at night until some early hour of the morning "surrounded by musicians of lesser note and wealth, whom, to a degree, he supports; also with him being many of the leading composers, librettists, actors, actresses, and singers of Vienna."

For Vienna coffee, the liquor is usually

made in a pumping percolator or by the drip process. In normal times it is served two parts coffee to one of hot milk topped with whipped cream. During 1914-18 and the subsequent post-war period, however, the sparkling crown of delicious whipped cream gave way to condensed milk, and saccharine took the place of sugar.

**BELGIUM.** In Belgium, the French drip method is most generally employed. Chicory is freely used as a modifier. The greatest coffee drinker among European monarchs of the 'twenties was said to be the late King Albert of the Belgians. His majesty took a cup of coffee before breakfast, after breakfast, at his noonday meal, in the afternoon, after dinner, and again in the evening.

**BRITISH ISLES.** In the British Isles coffee is still being boiled; although the infusion, true percolation (drip), and filtration methods have many advocates. A favorite device is the earthenware jug with or without the cotton sack that makes it a coffee biggin. When used without the sack



COFFEE IN THE OPEN IN PRESENT-DAY VIENNA  
Upper—Café Victoria, a fashionable coffee garden.  
Lower—Künstler Coffee House in the heart of the city.



the best practice is first to warm the jug. For each pint of liquor, one ounce (three dessert-spoonfuls) of freshly ground coffee is put in the pot. Upon it is poured freshly boiling water—three-fourths of the amount required. After stirring with a wooden spoon, the remainder of the water is poured in, and the pot is returned to the "hob" to infuse, and to settle for from three to five minutes. Some stir it a second time before the final settling.

The best trade authorities stress home-grinding, and are opposed to boiling the beverage. They advocate also its use as a breakfast beverage, after lunch, and after the evening meal.

From an American point of view, the principal defects in the English method of making coffee lie in the roasting, handling, and brewing. It has been charged that



FAVORITE ENGLISH COFFEE-MAKING METHOD

the beans are not properly cooked in the first place, and that they are too often stale before being ground. The English run to a light or cinnamon roast, whereas the best American practice requires a medium, high, or city roast. A fairly high shade of brown is favored on the South Downs with a light shade for Lancashire, the West Riding of Yorkshire, and the south of Scotland. The trade demands for the most part, a ripe chestnut brown.

In recent years there has been a marked improvement in English coffee roasting, due to the intelligent study brought to bear upon the subject by leaders of the trade's thought, and by the retail distributor, who, in the person of the retail grocer, is, generally speaking, better educated to his business than the retail grocer in any



AN A. B. C. SHOP, LONDON

other country. Years ago, it was the practice to use butter or lard to improve the appearance of the bean in roasting; but this is not so common as formerly.

The British consumer, however, will need much instruction before the national character of the beverage shows a uniform improvement. While the coffee may be more carefully roasted, better "cooked" than it was formerly, it is still remaining too long unsold after roasting, or else it is being ground too long a time before making. These abuses are, however, being corrected; and the consumer is everywhere being urged to buy his coffee freshly roasted and to have it freshly ground. Another factor has undoubtedly contributed to give England a bad name among lovers of good coffee, and that is certain tinned "coffees," composed of ground coffee and chicory, mixtures that attained some vogue for a time as "French" coffee. They found favor, perhaps, because they were easily handled. Package coffees have not been developed in England as in America; but there is a more or less limited field for



A CAFÉ OF YE MECCA COMPANY, LONDON



CAFÉ MONICO, PICCADILLY CIRCUS, LONDON

them, and there are several good brands of absolutely pure coffee on the market.

The demi-tasse is a popular drink after luncheon, after dinner, and even during the day, especially in the cities. In London, there are cafés that make a specialty of it; places like Peel's, Groom's, and the Café Nero in the city; also the shops of the London Café Co., and Ye Mecca Co.

While it is customary to steep coffee in the home, in hotels and restaurants some form of percolating apparatus, extractor, or steam machine is employed.

American visitors complain that coffee in England is too thick and syrupy for their liking. Coffee in restaurants is served "white" (with milk), or "black," in earthenstone-ware, or silver pots. In chain restaurants, like Lyons's or the A. B. C., there is to be found on the tariff, "hot milk with a dash of coffee."

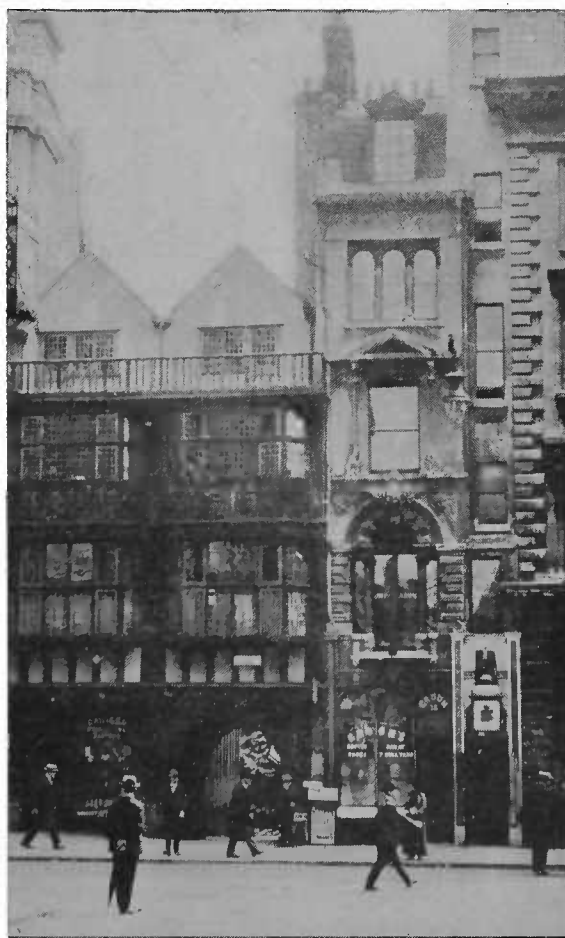
As to the boiling method, this is already generally discredited in the countries of western Europe. The steeping method so much favored in England may be responsible for some of the unkind things said about English coffee; because it undoubtedly leads to the abuse of over-infusion, so that the net result is as bad as boiling.

The vast majority of the English people are, however, confirmed tea drinkers, and it is extremely doubtful if this national habit, ingrained through centuries of use of "the cup that cheers," can ever be changed.

As already mentioned in this work, the London coffee houses of the seventeenth

and eighteenth centuries gave way to a type of coffee house whose mainstay was its food rather than its drink. In time, these too began to yield to the changing influences of a civilization that demanded modern hotels, luxurious tea lounges, smart restaurants, chain shops, tea rooms, and cafés with and without coffee. A certain type of "coffee shop," with rough boarded stalls, sanded floors and "private rooms," frequented by lower class workmen, were to be found in England for a time; but because of their doubtful character, they were closed up by the police.

Among other places in London where coffee may be had in English or continental style, mention should be made of the Café Monico, a good place to drop in for a coffee and liqueur, and one of the pioneers of the modern restaurant; Gatti's, where *café filtré*, or coffee produced by the filtration method, is a specialty; the cosmopolitan Savoy with its popular tea lounge; the Piccadilly Hotel, with its Louis XIV res-



GROOM'S COFFEE HOUSE, FLEET STREET, LONDON



TEA LOUNGE OF HOTEL SAVOY, LONDON

restaurant catering to refined and luxurious tastes; the Waldorf Hotel, with its American clientèle and its palm court; Lyons' Popular Café, with its iced coffee; the Trocadero with its special Indian curries prepared by native cooks once each week; the Temple Bar restaurant, an attractive refectory owned by the semi-philanthropic Trust-Houses, Ltd., which runs some two hundred similar establishments throughout the country, serving alcoholic drinks but stressing non-intoxicating beverages, among them special Mocha; Slater's, Ltd., owning about a score of restaurants and tea rooms



SLATER'S, A BETTER-CLASS CHAIN SHOP, LONDON

with retail shops attached; the British Tea Table Association, like Slater's, a grown-up sister of the olden bun shop of Queen Victoria's day; the Kardomah chain of cafés, where one is reasonably sure to get a satisfying cup of coffee and a cake; Café Royal; and Oddenino's.

Supplementing the above, Charles Cooper, some time editor of the *Epicure* and *The Table*, has prepared for this work some notes on the evolution of the old-time London coffee houses into the present-day tea rooms, tea lounges, cafés, and restaurants for all comers. Mr. Cooper says of the transformation:

The old-fashioned London coffee-house that flourished fifty to sixty years ago has within the past forty years been completely extinguished by the modern tea rooms. These old-fashioned establishments were mainly situated in and about the Strand and Fleet Street, the neighborhood of the Inns of Court, etc. They did not sacrifice much to outside show and decoration. They were divided into boxes or pews, and were gen-



TEMPLE BAR RESTAURANT, LONDON

erally speaking clean and well ordered; the prices were moderate, and the fare simple but superlatively good. There is nothing to equal it now. Chops were cooked in the grill. The tea and coffee were of the best; the hams were York hams and the bacon the best Wiltshire; they were the last places where real buttered toast was made. The art is now lost. They catered exclusively to men; and their clientèle consisted of journalists, artists, actors, men from the Inns of Court, students, *et al.* A man living in chambers could breakfast comfortably at one of these places, and read all the morning papers at his ease. The most westerly perhaps of the old houses was Stone's in Panton Street, Haymarket, which has recently been sold. Groom's in Fleet Street, where a good cup of coffee may still be had, is principally frequented by barristers about the luncheon hour. They are usually men who lunch lightly.

The tea rooms, as I have said, have killed the coffee houses. At the time the latter flourished,



GATTI'S, IN THE STRAND, LONDON

there were no facilities in London for a woman, unattended by a man, to obtain refreshment beyond a weak cup of tea at a few confectioners'. It mattered the less in the days when the girl clerk had not come into being. When the field of women's employment widened, fresh requirements were created which the coffee shops did not meet.

The tea room pioneers in London were the Aërated Bread Company, familiarly known as the A. B. C. I think that coffee palaces in provincial industrial centers had been started; but as part of a temperance propaganda, to



QUEBEC CAFÉ, LYONS CORNER HOUSE

counteract the attractions of the public house. The Aërated Bread Company was founded about the middle of the past century for the manufacture and sale of bread made under the patent aërated process of Dr. Daugleish. The shops were opened for the sale of bread to the public for home consumption; but to give people an opportunity of testing it, facilities were provided for obtaining a cup of tea, and bread and butter, on the premises. This subsidiary object became in a short time the most important part of the company's business. It multiplied its shops, enlarged its bill of fare to include cooked foods; and while, nowadays, the A. B. C. and its rivals cater to many thousands daily, I doubt if anybody ever buys a loaf to take home.

The A. B. C. has many competitors, similar shops having been started by Lyons, Lipton, Slaters, Express Dairy Company, Cabin, Pioneer Cafés, and others. *Ex uno disce omnes.* The fare in all these places is much alike, as are the general equipment, prices, and class of customers. They cater for a cheap class of business. In the busy centers they are frequented mostly by young men and girl clerks and shop assistants, by women in town, shopping, and such-like custom. Young employees can get a modest mid-day meal at a price to suit a shallow pocket. Before the war, the ruling price for a cup of



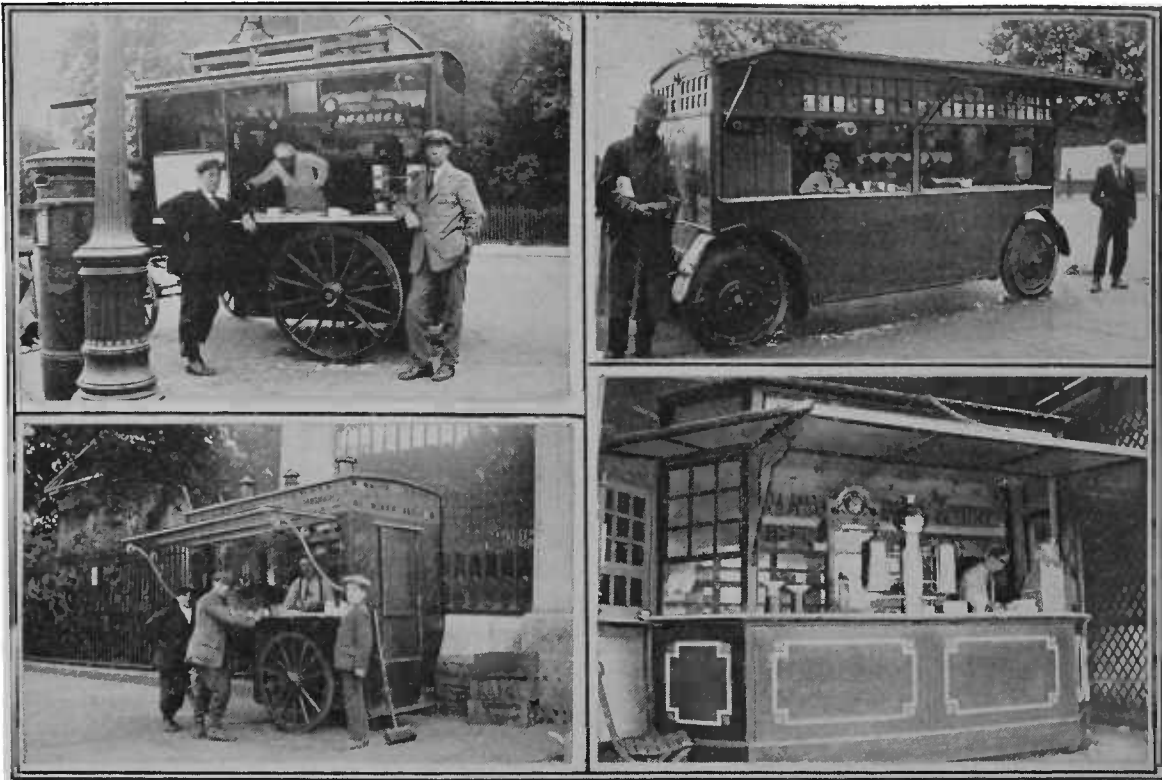
ST. JAMES'S RESTAURANT, PICCADILLY, LONDON

tea, and a roll and butter, was fourpence, and the general tariff in proportion. Nowadays, prices are up at least fifty percent. During the worst times of food control the fare was very scanty and very unappetizing. As a rule, it is plain and wholesome, with no pretense of being *recherché*. Tea is almost always very good; coffee not on the same level. Their tea rooms are all places designed for small, quick meals.

Lyons have refreshment-houses of different grades. The Popular Café is a cut above the tea rooms, and so are the Corner Houses. Some years ago, the A. B. C. amalgamated with Buszard's, an old established confectioner's in Oxford Street—a famous cake-house.

The Monico and Gatti's appeal to a quite different class from that catered to by the tea shops, although perhaps not to what Mrs. Boffin would call "the highfliers of fashion" who frequent the lounges of the fashionable hotels.





RENAISSANCE OF THE OLD-TIME COFFEE STALL IN MODERN LONDON

Upper left—at Kennington; upper right—Victoria Embankment; lower left—at Hyde Park Corner; lower right—electric lighted stall in Euston Road.

It is interesting to note that the Hotel Savoy was an outcome of the Gilbert and Sullivan operas of the seventies, D'Oyly Carte having expended some of his profits on building the hotel on a piece of waste ground by the Savoy Theatre. He brought over M. Ritz from Monte Carlo to manage the hotel and restaurant, and Escoffier, the greatest chef of the day, to preside over the cuisine. They made the Savoy famous for its dinners, and it has always maintained a high reputation, although Escoffier, who died in 1934, ruled later at the Carlton; and Ritz, at the hotel in Piccadilly.

One of the picturesque features of London life is the coffee stall. "A cup o' corfee and two doorsteps" was the usual demand of its patrons a generation or less ago, and then the stall was rather a ramshackle affair, consisting of a counter-board for cups and plates, shelves for those not in use, and for the comestibles, cover for the owner, and a canvas rain shelter for the customers. The coffee was mostly chicory and the "doorsteps," two slices, were honest bread when bread was as low as four pence the quarter loaf, and the covering frankly margarine. The owner would drag it himself to the pitch. One penny for the hot drink, a half penny for the

solid nutriment—there was a frugal meal for the poor beggar who had no more.

In recent years these old time hangouts of men frequently wanted by the police have given way to more luxurious coffee stalls on wheels where rich and poor, famous, and unknown, meet in real democracy. They cost as much as £750 to outfit. The coffee is better, the bill of fare more varied and the quality higher. The proprietor of two coffee stalls in good pitches is said to have netted £1,500 a year.

**BULGARIA.** In Bulgaria, Arabian-Turkish methods of making coffee prevail. The accompanying illustration shows a group in a caravan of the faithful on the annual pilgrimage to Mecca. The venerable Moslem, who is ambitious of becoming a hadji, is attended by his guards, distinguished by their fantastic dress; their glittering golden-hafted *hanjars*, stuck in their shawl girdles; and their silver-mounted pistols; the grave turban replaced by a many-tasseled cap. Their accommodation is the stable of a khan, or serai, shared with their camel. Their refreshment is coffee, thick, black and bitter, served in tiny cups.



In DENMARK and FINLAND coffee is made and served after the French and German fashion.

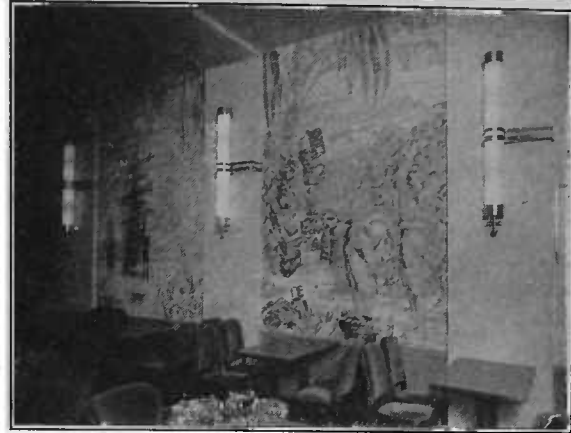
FRANCE. Were it not for the almost inevitable high roast and frequently the disconcerting chicory addition, coffee in France might be an unalloyed delight—at least this is how it appears to American eyes. One seldom, if ever, finds coffee improperly brewed in France—it is never boiled.

Second only to the United States, France consumes about three million bags of coffee annually. The varieties include coffee from the East Indies; Mocha; Haitian (a great favorite); Central American; Colombian; and Brazils.

Although there are many wholesale and retail coffee roasters in France, home roasting persists, particularly in the country districts. The little sheet-iron cylinder roasters, that are hand-turned over an iron box holding the charcoal fire, find a ready sale even in the modern department stores of the big cities. In any village or city in France it is a common sight on a pleasant day to find the householder turning his roaster on the curb in front of his home. Emmet G. Beeson, in *The Tea and Coffee Trade Journal* gives us this vignette of



HALT OF CARAVANERS AT A SERAI, BULGARIA



COFFEE MURAL IN A DANISH RESTAURANT

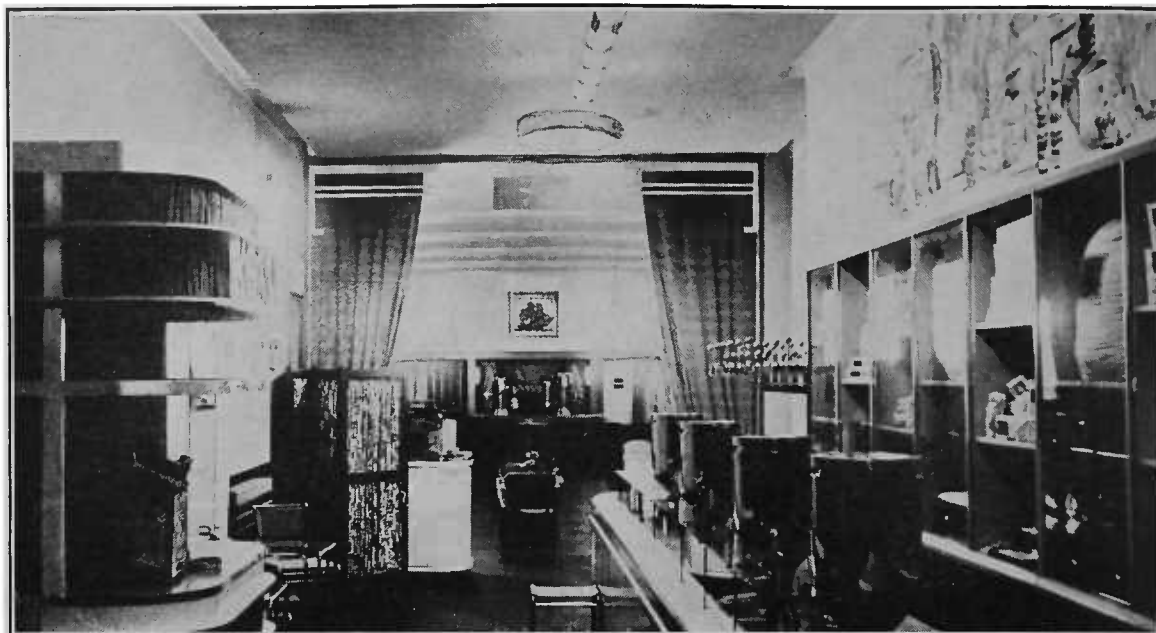
rural coffee roasting in the south of France:

In a certain town in the south of France I saw an old man with an outfit a little larger than the home variety, a machine with a capacity of about ten pounds. Instead of a cylinder in which to roast his coffee, he had perched on a sheet-iron frame a hollow round ball made of sheet iron. In the top of this ball there was a little slide which was opened by the means of a metal tool. In the sheet-iron frame he had kindled his charcoal fire. Directly in front of his roaster was a home-made cooling pan, the sides of which were of wood, the bottom covered with a fine grade of wire screening.

On this particular afternoon, the old man had taken up his place on the curb; and a big black cat had taken advantage of the warmth offered by the charcoal fire and was curled up, sleeping peacefully in the pan nearest the fire. The old man paid no attention to the cat, but went on rotating his ball of coffee and puffing away pensively on his cigarette. When his coffee had become blackened and burned, and blackened and burned it was, he stopped rotating the ball, opened the slide in the top, turned it over, and the hot, burned coffee rolled out, and much to his delight, on the sleeping cat, which leaped out of the pan and scampered up the street and into a hole under an old building.

I afterward learned that this old fellow made a business of going about the town gathering up coffee from the houses along the way and roasting it at a few sous per kilo, much the same fashion as a scissors grinder plies his trade in an American town.

Quite a few grocers roast their own coffee in crude devices much like those described above; but the large coffee roasters are gradually eliminating this sort of procedure. Shopkeepers in Paris and other large cities roast their coffee fresh daily. The machines used are mostly of the cylinder type, employing gas fuel and turned by electric power. Invariably they stand where they may be seen from the street.



COFFEE HOUSE IN COPENHAGEN, DENMARK, ESTABLISHED FOR BRAZIL COFFEE PROPAGANDA

Sample-roasters, or testing tables, in France are conspicuous by their absence. Inquiry regarding this subject discloses that coffee is sold on description; and when the French trader is asked, "How do you know your delivery is up to description so far as cup quality is concerned?" he answers that this is arrived at from the general appearance and the smell of the coffee in the green. Perhaps one reason for the laxity in buying cup quality may be explained by the fact that coffee is roasted very high, in fact it is burned almost to a charred state; and unless the coffee is unusually bad in character, the burned taste eliminates any foreign flavor it may have.

The fact that coffee was, and still is, quite generally sold to the consumer green, accounts for Central American coffees taking first place. Style takes preference over everything else when it comes to selling to a Frenchman.

To the American coffee merchant it seems that the French are carrying their artistic tastes to an unreasonable extreme when they apply them to coffee; for coffee is grown to drink and not to look at.

Since the coming of the large coffee roaster, who delivers roasted coffee right down the line to the consumer, Santos has come in for its share of the business. The roasters are getting good results out of

Santos blends, up to fifty and sixty per cent with West Indian and Central American coffees.

In Brittany the demand is for peaberry coffee, no matter of what variety. This comes about from the fact that the people of this section of the country still do a great deal of their roasting at home, and have become accustomed to the use of peaberry coffee because they do not have the improved hand roasters, and still do a great deal of their roasting in pans in the ovens of their stoves. The peaberry coffee rolls about so nicely in the pan that they get a much more uniform roast.

Nearly all the coffee is ground at home, which is not a bad practice for the consumer; but perhaps works hardship on the dealer, who can mix some grade grinders into his blends without doing them any material harm. Where coffee mills are used in the stores, they are of the "strong-arm" variety and of an ancient heritage. To get a growl out of a grocer in France, buy a kilo of coffee and ask him to grind it.

Package coffee and proprietary brands have not come into their own to the extent that they have in the United States, although there are at present several firms that have started in this business and are advertising extensively on billboards, in street cars, and in the subways. However, most coffee is still sold in bulk. The butter,

egg, and cheese stores of France do a large business in coffee. Prior to the war and high prices, there were some very large firms doing a premium business in coffee, tea, spices, etc. They still exist, and have a very fine trade; but since the high prices of coffees and premiums, the business has gone down very materially. They operate by the delivery-route and solicitor method, just as some of our American companies do. One large firm in Paris has been in this business for more than 50 years, operating branches and deliveries in every town, village, and hamlet in France.

The consumption of coffee is increasing in France; some say, on account of the high price of wine, others hold that coffee is simply growing in favor with the people. Among the masses, French breakfast consists of a bowl or cup of *café au lait*, or half a cup or bowl of strong black coffee and chicory, and half a cup of hot milk, and a yard of bread. The workman turns his bread on end and inserts it into his bowl of coffee, allowing it to soak up as much of the liquid as possible. Then he proceeds to suck this concoction into his system. His approval is demonstrated by the amount of noise he makes in the operation.

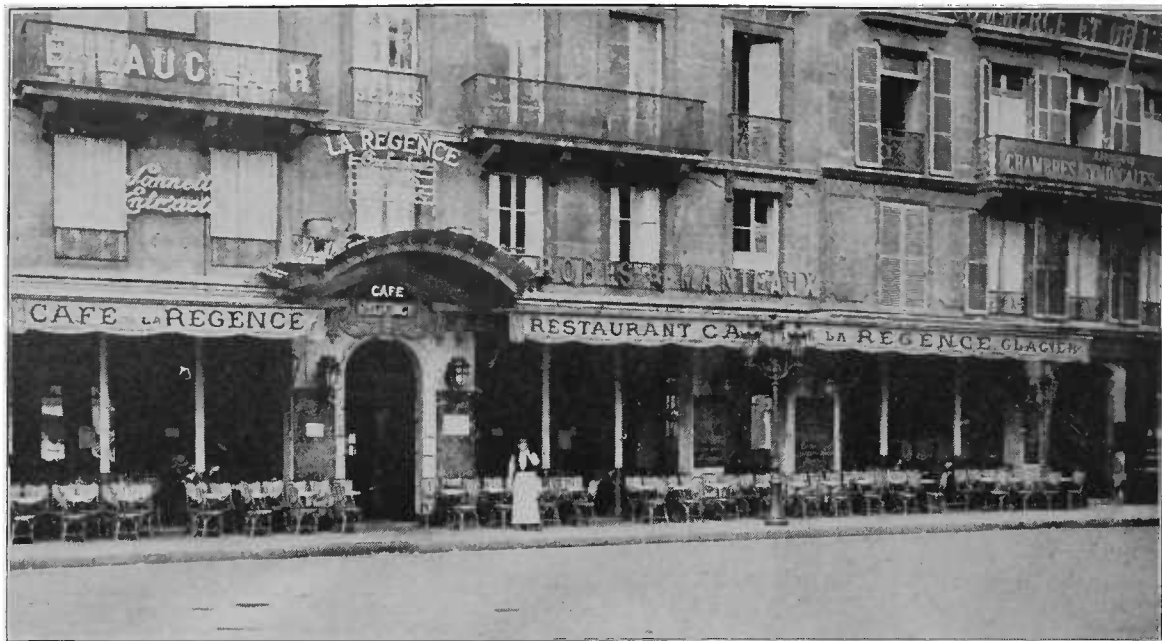
Among the better classes, the breakfast is *café au lait*, with rolls and butter, and

sometimes fruit. The brew is prepared by the drip, or true percolator, method or by filtration. Boiling milk is poured into the cup from a pot held in one hand together with the brewed coffee from a pot held in the other, providing a simultaneous mixture. The proportions vary from half-and-half to one part coffee and three parts milk. Sometimes, the service is by pouring into the cup a little coffee then the same quantity of milk and alternating in this way until the cup is filled.

Coffee is never drunk with any meal but breakfast, but is invariably served *en demi-tasse* after the noon and the evening meals. In the home, the usual thing after luncheon or dinner is to go into the *salon* and have your demi-tasse and liqueur and cigarettes before a cosy grate fire. A Frenchman's idea of after-dinner coffee is a brew that is unusually thick and black, and he invariably takes with it his liqueur, no matter if he has had a cocktail for an appetizer, a bottle of red wine with his meat course, and a bottle of white wine with the salad and dessert course. When the demi-tasse comes along, with it must be served his cordial in the shape of cognac, benedictine, or *crème de menthe*. He can not conceive of a man not taking a little alcohol with his after-dinner coffee, as an aid, he says, to digestion.



CAFÉ DE LA PAIX, WHERE PARIS DRINKS ITS COFFEE OUTDOORS



CAFÉ DE LA RÉGENCE, PARIS, IN 1922

In Normandy, there prevails a custom in connection with coffee drinking that is unique. They produce in this province great quantities of what is known as *cidre*, made from a particular variety of apple grown there—in other words, just plain hard cider. However, they distil this hard cider, and from the distillation they get a drink called *calvados*.

The man from Normandy takes half a cup of coffee, and fills the cup with *calvados*, sweetened with sugar, and drinks it with seeming relish. Ice-cold coffee will almost sizzle when *calvados* is poured into it. It tastes like a corkscrew, and one drink has the same effect as a crack on the head with a hammer. From the toddling age up, the Norman takes his *calvados* and coffee.

In the South of France they make a concoction from the residue of grapes. They boil the residue down in water, and get a drink called *marc*; and it is used in much the same way as the Norman in the north uses *calvados*. Then there is also the very popular summer-time drink known as *mazagran*, which in that region means seltzer water and cold coffee.

Making coffee in France has been, and always will be, by the drip and the filtration methods. The large hotels and cafés follow these methods almost entirely, and so does the housewife. When company comes, and something unusual in coffee is

to be served, the cook will drip the coffee, using a spoonful of hot water at a time, pouring it over tightly packed, finely ground coffee, allowing the water to percolate through to extract every particle of oil. They use more ground coffee in bulk than they get liquid in the cup, and sometimes spend an hour producing four or five demi-tasses. It is needless to say that it is more like molasses than coffee when ready for drinking.

It is not unusual in some parts of France to save the coffee grounds for a second or even a third infusion, but this is not considered good practice.

Von Liebig's idea of correct coffee making has been adapted to French practice in some instances after this fashion: put used coffee grounds in the bottom chamber of a drip coffee pot. Put freshly ground coffee in the upper chamber. Pour on boiling water. The theory is that the old coffee furnishes body and strength, and the fresh coffee the aroma.

The cafés that line the boulevards of Paris and the larger cities of France all serve coffee, either plain or with milk, and almost always with liqueur. The coffee house in France may be said to be the wine house; or the wine house may be said to be the coffee house. They are inseparable. In the smallest or the largest of these establishments coffee can be had at any time of day or night. The proprietor



of a very large café in Paris says his coffee sales during the day almost equal his wine sales.

The French, young or old, take a great deal of pleasure in sitting out on the sidewalk in front of a café, sipping coffee or liqueur. Here they love to idle away the time just watching the passing show.

In Paris, there are hundreds of these cafés lining the boulevards, where one may sit for hours before the small tables reading the newspapers, writing letters, or merely idling. In the morning, from eight to eleven, employees, men-about-town, tourists, and provincials throng the cafés for *café au lait*. The waiters are coldly polite. They bring the papers, and brush the table—twice for *café crème* (milk), and three times for *café complet* (with bread and butter).

In the afternoon, *café* means a small cup or glass of *café noir*, or *café nature*. It is double the usual amount of coffee dripped by percolator or filtration device, the process consuming eight to ten minutes. Some understand *café noir* to mean equal parts of coffee and brandy with sugar and vanilla to taste. When *café noir* is mixed



RESTAURANT PROCOPE, 1922  
Successor to the famous "Cave" of 1689

with an equal quantity of cognac alone it becomes *café gloria*. *Café mazagan* is also much in demand in the summer-time. The coffee base is made as for *café noir*, and it is served in a tall glass with water to dilute it to one's taste.

Few of the cafés that made Paris famous



INTERIOR OF A MODERNISTIC COFFEE BAR IN PARIS

Fontenelle's famous bon mot is fitted into the decorative scheme. Being told that coffee was a slow poison, Fontenelle, who lived to be a hundred, replied, "I think it must be, for I've been drinking it for 85 years and I am not dead yet."





ONE OF THE BIARD CAFES

There are about 200 of these coffee and wine shops in Paris. They are frequented mostly by laborers, clerks, and midnettes.

in the eighteenth century survive. Among those that are notable for their coffee service are the Café de la Paix; the Café de la Régence, founded in 1718; and the Café Prévost, noted also for chocolate.

**GERMANY.** Germany originated the afternoon-coffee function known as the kaffee-klatsch. Even today, the German family's reunion takes place around the coffee table on Sunday afternoons. In summer, when weather permits, the family will take a walk into the suburbs, and stop at a garden where coffee is sold in pots. The proprietor furnishes the coffee, the cups, the spoons and, in normal times, the sugar, two pieces to each cup; and the patrons bring their own cake. They put one piece of sugar into each cup and take the other pieces home to the "canary bird," meaning the sugar bowl in the pantry.

Cheaper coffee is served in some gardens, which conspicuously display large signs at the entrance, saying: "Families may cook their own coffee in this place." In such a garden, the patron merely buys the hot water from the proprietor, furnishing the ground coffee and cake himself.

While waiting for the coffee to brew, he may listen to the band and watch the children play under the trees. French or Vienna drip pots are used for brewing.

Every city in Germany has its cafés, spacious places where patrons sit around

small tables, drinking coffee, "with or without," turned or unturned, steaming or iced, sweetened or unsweetened, depending on the sugar supply; nibble, at the same time, a piece of cake or pastry, selected from a glass pyramid; talk, flirt, malign, yawn, read, and smoke. Cafés are, in fact, public reading rooms. Some places keep hundreds of daily and weekly newspapers and magazines on file for the use of patrons. If the customer buys only one cup of coffee, he may keep his seat for hours, and read one newspaper after another.

Three of the four corners of Berlin's most important street crossing are occupied by cafés. This is where Unter den Linden and Friedrichstrasse meet. On the southwest corner there is Kranzler's staid old café, a very respectable place, where the lower hall is even reserved for non-smokers. On the southeast corner is Café Bauer, known the world over. However, it has seen better days. It has been outdistanced by competitors. On the northeast corner is the Victoria, a new-style place, very bright, and less staid. There no room is reserved for non-smokers, for most of the ladies, if they do not themselves smoke, will light the cigars for their escorts.

Around the Potsdamer Platz there are a number of cafés. Josty's is perhaps the most frequented in Berlin. It is the best liked on account of the trees and terraces in front. Farther to the west, on Kurfuerstendamm, there are dozens of large cafés.

Some of the cafés are meeting-places for certain professions and trades. The Admiral's Café, in Friedrichstrasse, for instance, is the "artistes'" exchange. All the stage folk and stars of the tanbark meet there every day. Chorus girls, tumblers,



INTERIOR, CAFÉ BAUER, BERLIN



CAFE BAUER, UNTER DEN LINDEN, BERLIN

ladies of the flying trapeze, contortionists, and bareback riders are to be found there, discussing their grievances, denouncing their managers, swapping their diamonds, and recounting former triumphs. Cinemamakers come also to pick out a cast for a new film play. There one can pick out a full cast every minute.

Then there is the Café des Westens in Kurfuerstendamm, the old one, where dreamers and poets congregate. It is called also Café Groessenwahn, which means that persons suffering from an exaggerated ego are conspicuous by their presence.

Saxony and Thuringia are proverbial hotbeds of coffee lovers. It is said that in Saxony there are more coffee drinkers to the square inch and more cups to the single coffee bean than anywhere else upon earth. The Saxons like their coffee, but seem to be afraid it may be too strong for them. So, when over their cups, they always make certain they can see bottom before raising the steaming bowl to the lip.

Von Liebig's method of making coffee, whereby three-fourths of the quantity to be used, is first boiled for ten or fifteen minutes, and the remainder added for a six-minute steeping or infusion, is religiously followed by some housekeepers. Von Liebig advocated coating the bean with sugar. In some families, fats, eggs, and egg-shells are used to settle and to clarify the beverage.

Coffee in Germany is better cooked (roasted) and more scientifically prepared than in many other European countries. In recent years, during the World War and since, however, there has been an amazing increase in the use of coffee substitutes, so that the German cup of coffee is not the pure delight it was once.

GREECE. Coffee is the most popular and most extensively used non-alcoholic beverage in Greece, as it is throughout the Near East. Its annual per capita consumption there is about two pounds, two-thirds of the supply coming *via* Austria and France, Brazil furnishing direct the bulk of the remaining third.

Coffee is given a high or city roast, and is used almost entirely in powdered form. It is prepared for consumption principally in the Turkish *demi-tasse* way. Finely ground coffee is used even in making ordinary table, or breakfast, coffee. In private houses the cylindrical brass hand-grinders, manufactured in Constantinople, are mostly used. In many of the coffee houses in the villages and country towns throughout Greece and the Levant, a heavy iron pestle, wielded by a strong man, is employed to pulverize the beans in a heavy stone or marble mortar; while the poorer homes use a small brass pestle and mortar, also manufactured in Turkey.

In his *The Greeks of the Present Day*, Edmond François Valentin About says:

The coffee which is drunk in all the Greek houses rather astonishes the travellers who have neither seen Turkey nor Algeria. One is surprised at finding food in a cup in which one expected drink. Yet you get accustomed to this coffee-broth and end by finding it more savoury, lighter, more perfumed, and especially more wholesome, than the extract of coffee you drink in France.<sup>6</sup>

Then About gives the recipe of his servant Petros, who is "the first man in Athens for coffee":

The grain is roasted without burning it; it is reduced to an impalable powder, either in a mortar or in a very close-grained mill. Water

<sup>6</sup> New York, 1857 (p. 276).



KRANZLER'S, UNTER DEN LINDEN, BERLIN



A CUP OF COFFEE AT FLORIAN'S FAMOUS CAFÉ IN THE PIAZZA SAN MARCO, VENICE

is set on the fire till it boils up; it is taken off to throw in a spoonful of coffee, and a spoonful of pounded sugar for each cup it is intended to make; it is carefully mixed; the coffee pot is replaced on the fire until the contents seem ready to boil over; it is taken off, and set on again; lastly it is quickly poured into the cups. Some coffee drinkers have this preparation boiled as many as five times. Petros makes a rule of not putting his coffee more than three times on the fire. He takes care in filling the cups to divide impartially the coloured froth which rises above the coffee pot; it is the *kaimaki* of the coffee. A cup without *kaimaki* is disgraced.

When the coffee is poured out you are at liberty to drink it boiling and muddy, or cold and clear. Real amateurs drink it without waiting. Those who allow the sediment to settle down, do not do so from contempt, for they afterwards collect it with the little finger and eat it carefully.

Thus prepared, coffee may be taken without inconvenience ten times a day: five cups of French coffee could not be drunk with impunity every day. It is because the coffee of the Turks and the Greeks is a diluted tonic, and ours is a concentrated tonic.

I have met at Paris many people who took their coffee without sugar, to imitate the Orientals. I think I ought to give them notice, between ourselves, that in the great coffee-houses of Athens, sugar is always presented with the coffee; in the khans and second-rate coffee-houses, it is served already sugared; and that at Smyrna and Constantinople, it has everywhere been brought to me sugared.

ITALY. In Italy coffee is roasted in a wholesale and retail way as well as in the home. French, German, Dutch, and Italian machines are used. The full city, or Italian, roast is favored. There are cafés as in France and other continental countries, and the drink is prepared in the French fashion. For restaurants and hotels, rapid filtering machines, first developed by the French and Italians, are

used. In the homes, percolators and filtration devices are employed.

The Italians pay particular attention to the temperature in roasting and in the cooling operation. There is considerable glazing, and many coffee additions are used.

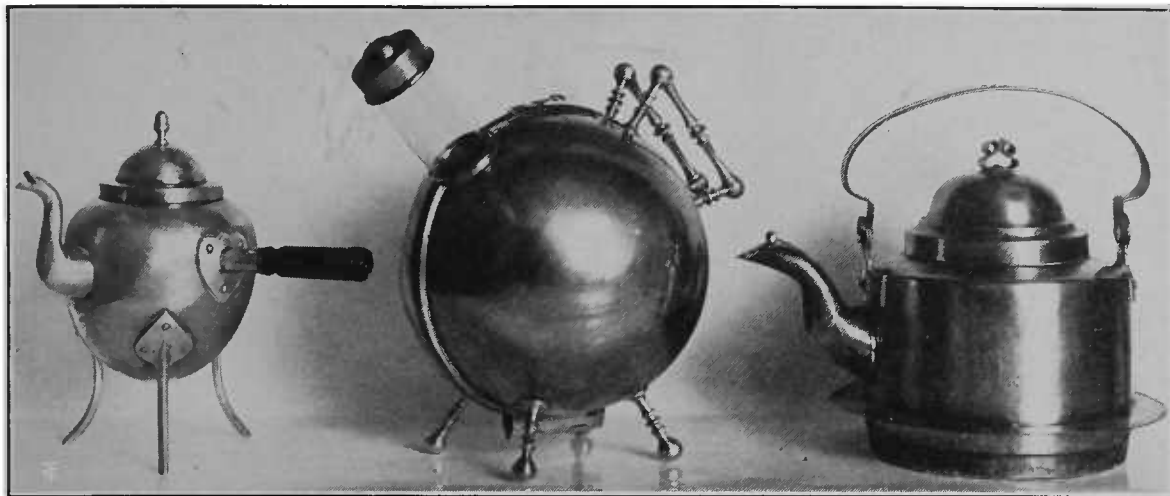
Like the French, the Italians make much of *café au lait* for breakfast. At dinner, the *café noir* is served.

Cafés of the French school are to be found along the Corso in Rome, the Toledo in Naples, in the Galleria Vittorio Emanuel and the Piazza del Duomo in Milan, and in the arcades surrounding the Piazza de San Marco in Venice, where Florian's still flourishes.

NETHERLANDS. In the Netherlands, too, the French café is a delightful feature of the life of the larger cities. The Dutch roast coffee properly, and make it well. The service is in individual pots, or in demi-tasses on a silver, nickel, or brass tray, and accompanied by a miniature pitcher containing just enough cream (usually whipped), a small dish about the size of an individual butter plate holding three squares of sugar, and a slender glass of water. This service is universal; the glass of water always goes with the coffee. It is the one sure way for Americans to



INTERIOR OF FLORIAN'S CAFÉ  
This is the Hall of Mirrors and of Summers.



THESE COFFEE POTS ARE WIDELY USED IN SWEDEN FOR BOILING COFFEE

*Left*, copper pot with wooden handle and iron legs designed to stand in the coals; *center*, glass-globe pot, for stove use, enclosed in felt-lined brass case; *right*, hand-made hammered-brass kettle for stove use.

get a drink of water. It is the custom in Holland to repair to some open-air café or indoor coffee house for the after-dinner cup of coffee. One seldom takes his coffee in the place where he has his dinner. These cafés are many, and some are elaborately designed and furnished. One of the most interesting is the St. Joris at the Hague, furnished in the old Dutch style. The approved way of making coffee in Holland is the French drip method.

**NORWAY AND SWEDEN.** French and German influences mark the roasting, grinding, preparing, and serving of coffee in Norway and Sweden. Generally speaking, not so much chicory is used, and a great deal of whipped cream is employed. In Norway, the boiling method has many followers. A big (open) copper kettle is used. This is filled with water, and the coffee is dumped in and boiled. In the poorer-class country homes, the copper kettle is brought to the table and set upon a wooden plate. The coffee is served directly from the kettle in cups. In better-class homes, the coffee is poured from the kettle into silver coffee pots in the kitchen, and the silver coffee pots are brought to the table. The only thing approaching coffee houses are "coffee rooms" in the city of Oslo. These are small one-room affairs in which the plainer sorts of foods, such as porridge, may be purchased with the coffee. They are cheap, and are largely frequented by the poorer class of students, who use them as places in which to study while they drink their coffee.

In **RUSSIA** and **SWITZERLAND**, French and German methods obtain. Russia, however, drinks more tea than coffee, which by the masses is prepared in Turkish fashion, when obtainable. Usually, the coffee is only a cheap "substitute." The so-called *café à la Russe* of the aristocracy, is strong black coffee flavored with lemon. Another Russian recipe calls for the coffee to be placed in a large punch bowl, and covered with a layer of finely chopped apples and pears; then cognac is poured over the mass, and a match applied.

**RUMANIA** and **SERVIA** drink coffee prepared after either the Turkish or the French style, depending on the class of the drinker and where it is served. Substitutes are numerous.

In **SPAIN** and **PORTUGAL** the French type of café flourishes as in Italy. In Madrid,



TEA AND COFFEE HOUR AT SCHEVENINGEN, HOLLAND



SIDEWALK CAFÉ, LISBON

some delightful cafés are to be found around the Puerto del Sol, where coffee and chocolate are the favorite drinks. The coffee is made by the drip process, and is served in French fashion.

#### *Coffee Manners and Customs in North America*

The introduction of coffee and tea into North America effected a great change in the meal-time beverages of the people. Malt beverages used at first were succeeded by alcoholic spirits and cider. These in turn were supplanted by tea and coffee.

CANADA. In Canada, we find both French and English influences at work in the preparation and serving of the beverage; "Yankee" ideas also entered from across the border. Some years back—about 1910—A. McGill, chief chemist of the Canadian Inland Revenue Department, suggested an improvement upon Baron von Liebig's method, whereby Canadians might obtain an ideal cup of coffee. It was to combine two well-known methods. One was to boil a quantity of ground coffee to get a maximum of body or soluble matter. The other was to percolate a similar quantity to get the needed *cafféol*. By combining the decoction and the infusion, a finished beverage rich in body and aroma might be had. Most Canadians continue to drink tea, however, although coffee consumption is increasing.

MEXICO. In Mexico, the natives have a custom peculiarly their own. The roasted beans are pounded to a powder in a cloth bag which is then immersed in a pot of boiling water and milk. The *vaquero*, however, pours boiling water on the powdered

coffee in his drinking cup, and sweetens it with a brown sugar stick.

Among the upper classes in Mexico the following interesting method obtains for making coffee:

Roast one pound until the beans are brown inside. Mix with the roasted coffee one teaspoonful of butter, one of sugar, and a little brandy. Cover with a thick cloth. Cool for one hour; then grind. Boil one quart of water. When boiling, put in the coffee and remove from fire immediately. Let it stand a few hours, and strain through a flannel bag, and keep in a stone jar until required for use; then heat quantity required.

UNITED STATES. In no country has there been so marked an improvement in coffee making as in the United States. Although in many parts, the national beverage is still indifferently prepared, the progress made in recent years has been so great that the friends of coffee are hopeful that before long it may be said truly that coffee making in America is a national honor, and no longer the national disgrace that it was in the past.

Already, in the more progressive homes, and in the best hotels and restaurants, the coffee is uniformly good, and the service all that it should be. The American breakfast cup is a food-beverage because of the additions of milk or cream and sugar; and unlike Europe, this same generous cup serves again as a necessary part of the



BRITANNIA COFFEE POT FROM WHICH ABRAHAM LINCOLN WAS OFTEN SERVED IN NEW SALEM  
Its story is told on page 732



noonday and evening meals for most people.

During prohibition, there was an increase in coffee drinking that directly took the place of malt and spiritous liquors. There also came into being the hotel coffee room; the custom of afternoon coffee drinking; and free coffee-service in many factories, stores, and offices.

In colonial days, must or ale first gave way to tea, and then to coffee as a breakfast beverage. The Boston "tea party" clinched the case for coffee; but in the meantime, coffee was more or less of an after-dinner function, or a between-meals drink, as in Europe. In Washington's time, dinner was usually served at three o'clock in the afternoon, and at informal dinner parties the company "sat till sunset—then coffee."

In the early part of the nineteenth century, coffee became firmly entrenched as the one great American breakfast beverage; and its security in this position would seem to be unassailable for all time.

Today, all classes in the United States begin and end the day with coffee. In the home, it is prepared by boiling, infusion or steeping, percolation, and filtration; in the hotels and restaurants, by infusion, percolation, and filtration. The best practice favors true percolation (French drip), or filtration.

Steeping coffee in American homes—an English heirloom—is usually performed in a china or earthenware jug. The ground coffee has boiling water poured upon it until the jug is half full. The infusion is stirred briskly. Next, the jug is filled by pouring in the remainder of the boiling water, the infusion is again stirred, then permitted to settle, and finally is poured through a strainer or filter cloth before serving.

When a pumping percolator or a double glass filtration device is used, the water may be cold or boiling at the beginning as the maker prefers. Some wet the coffee with cold water before starting the brewing process.

For genuine percolator, or drip coffee there are a number of American-made devices on the market that are correct in principle and attractive in appearance. The latest filtration devices are described in chapter XXXV.

The Creole, or French market coffee for which New Orleans has long been famous

is made from a concentrated coffee extract prepared in a drip pot. First, the ground coffee has poured over it sufficient boiling water thoroughly to dampen it, after which further additions of boiling water, a tablespoonful at a time, are poured upon it at five-minute intervals. The resulting extract is kept in a tightly corked bottle for making *café au lait* or *café noir* as required. A variant of the Creole method is to brown three tablespoonfuls of sugar in a pan, to add a cup of water, and to allow it to simmer until the sugar is dissolved; to pour this liquid over ground coffee in a drip pot, to add boiling water as required, and to serve black or with cream or hot milk, as desired.

In New Orleans, coffee is often served at the bedside upon waking, as a kind of early breakfast function.

The Philadelphia Centennial Exposition of 1876 served to introduce the Vienna *café* to America. Fleischmann's Vienna *Café* and Bakery was a feature of our first international exposition. Aftaerward, it was transferred to Broadway, New York, where for many years it continued to serve excellent coffee in Vienna style next door to Grace Church.

The opportunity is still waiting for the courageous soul who will bring back to our larger cities this Vienna *café* or some Americanized form of the continental or sidewalk *café*, making a specialty of tea, coffee, and chocolate.

The old Astor House was famous for its coffee for many years, as was also Dorlon's from 1840 to 1922.

Members of the family of the late Colonel Roosevelt began to promote a Brazil coffee-house enterprise in New York in 1919. It was first called *Café Paulista*, but afterwards was known as the Double R coffee house, or Club of South America, with a Brazil branch in the 40's and an Argentine branch on Lexington Avenue. Coffee was made and served in Brazilian style; that is, full city roast, pulverized grind, filtration made, service, black or with hot milk. Sandwiches, cakes, and crullers were also to be had. The enterprise was not a success. Indeed it is doubtful if there are enough Latins even in New York to support a coffee house which serves coffee only in the Brazilian manner.

One of New York's exclusive clubs is known as the Coffee House. It is in West Forty-fifth Street, and has been in exist-

ence since December, 1915, when it was opened with an informal dinner, at which the late Joseph H. Choate, one of the original members, outlined the purpose and policies of the club.

The founders of the Coffee House were convinced—as the result of the high dues and constantly increasing formality and discipline in the social clubs in New York—that there was need here for a moderate-priced eating and meeting place, which should be run in the simplest possible way and with the least possible expense.

At the beginning of its career, the club framed, adopted, and has since lived up to, a most informal constitution: “No officers, no liveries, no tips, no set speeches, no charge accounts, no RULES.”



THE SILEX INDIVIDUAL TABLE SERVICE IN A HOTEL AT HARTFORD, CONN.

The membership is made up, for the most part, of painters, writers, sculptors, architects, actors, and members of other professions. Members are expected to pay cash for all orders. There are no proposals of candidates for membership. The club invites to join it those whom it believes to be in sympathy with the ideals of its founders.

The method of preparing coffee for individual service in the Waldorf-Astoria, New York, which has been adopted by many first-class hotels and restaurants that do not serve urn-made coffee exclusively, is the French drip plus careful attention to all the contributing factors for making coffee in perfection, and is thus described by the hotel's steward:

A French china drip coffee pot is used. It is kept in a warm heater; and when the coffee is ordered, this pot is scalded with hot water. A level tablespoonful of coffee, ground to about



COFFEE SERVICE, HOTEL ASTOR, NEW YORK

the consistency of granulated sugar, is put into the upper and percolator part of the coffee pot. Fresh boiling water is then poured through the coffee and allowed to percolate into the lower part of the pot. The secret of success, according to our experience, lies in having the coffee freshly ground, and the water as near the boiling point as possible, all during the process. For this reason, the coffee pot should be placed on a gas stove or range. The quantity of coffee can be varied to suit individual taste. We use about ten per cent more ground coffee for after dinner cups than we do for breakfast. Our coffee is a mixture of Java and Bogota.

C. Scotty, chef at the Hotel Ambassador, New York, thus describes the method of making coffee in that hostelry:



THE DEMI-TASSE CORNER AT THE RITZ, NEW YORK



IN BRAZIL, EVERYWHERE ONE GOES, BLACK COFFEE IS SERVED EN DEMI-TASSE

The scene is the Coffee Exchange at Rio on the occasion of the visit of the American Coffee Delegation in 1934.

In the first place, it is essential that the coffee be of the finest quality obtainable; secondly, better results are obtained by using the French filterer, or coffee bag.

Twelve ounces of coffee to one gallon of water for breakfast.

Sixteen ounces of coffee to one gallon of water for dinner.

Boiling water should be poured over the coffee, siphoned, and put back several times. We do not allow the coffee grounds to remain in the urn for more than fifteen to twenty minutes at any time.

The coffee service at the best hotels is usually in silver pots and pitchers, and includes the freshly made coffee, hot milk or cream (sometimes both), and loaf sugar.

Many of the leading hotels, and some of the big railway systems, have adopted the custom of serving free a demi-tasse of coffee as soon as the guest-traveler seats himself at the breakfast table or in the dining car. "Small blacks," the waiters call them, or "coffee cocktails."

*Coffee Customs in South America*

**ARGENTINE.** Coffee is popular as a beverage in Argentina. *Café con leche*—coffee with milk, in which the proportion of coffee may vary from one-fourth to two-

thirds—is the usual Argentine breakfast beverage. A small cup of coffee is generally taken after meals, and it is also consumed to a considerable extent in cafés.

**BRAZIL.** In Brazil every one drinks coffee and at all hours. Cafés making a specialty of the beverage, and modeled after continental originals, are to be found a-plenty in Rio de Janeiro, Santos, and São Paulo. The custom prevails of roasting the beans high, almost to carbonization, grinding them fine, and then boiling after the Turkish fashion, percolating in French drip pots, steeping in cold water for several hours, straining and heating the liquid for use as needed, or filtering by means of conical linen sacks suspended from wire rings.

The Brazilian loves to frequent the cafés and to sip his coffee at his ease. He is quite continental in this respect. The wide-open doors, and the round-topped marble tables, with their small cups and saucers set around a sugar basin, make inviting pictures. The customer pulls toward him one of the cups, fills it half full of soft sugar, and immediately a waiter comes to fill what remains with coffee, the charge for which is a *tostão*, or about 1½ cents. It is a com-



COFFEE UNDER THE TREES, PARQUE BERRIO,  
MEDELLIN, COLOMBIA

mon thing for a Brazilian to consume one dozen to two dozen cups of black coffee a day. If one pays a social visit, calls upon the president of the Republic, or any lesser official, or on a business acquaintance, it is a signal for an attendant to serve coffee. *Café au lait* is popular in the morning; but except for this service, milk or cream is never used. In Brazil, as in the Orient, coffee is a symbol of hospitality.

In COLOMBIA, as in most Latin-American countries, coffee is a concomitant of all social and business discourse. In clubs, restaurants, hotels, or in sidewalk cafes,

people are always and ever drinking black coffee *en demi-tasse*.

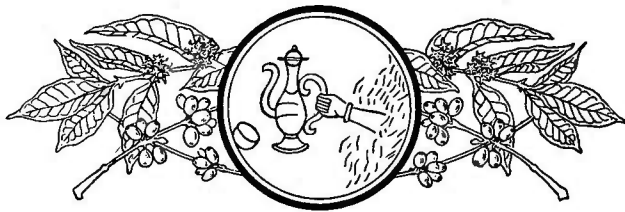
In CHILE, PARAGUAY and URUGUAY, very much the same customs prevail of making and serving the beverage.

#### *Coffee Drinking in Other Countries*

In AUSTRALIA and NEW ZEALAND, English methods for roasting, grinding, and making coffee are standard. The beverage usually contains thirty to forty per cent chicory. In the bush, the water is boiled in a billy can. Then the powdered coffee is added; and when the liquid comes again to a boil, the coffee is done. In the cities, practically the same method is followed. The general rule in the antipodes seems to be to "let it come to a boil," and then to remove it from the fire.

In CUBA the custom is to grind the coffee fine, to put it in a flannel sack suspended over a receiving vessel, and to pour cold water on it. This is repeated many times, until the coffee mass is well saturated. The first drippings are repoured over the bag. The final result is a highly concentrated extract, which serves for making *café au lait*, or *café noir*, as desired.

In MARTINIQUE, PANAMA, and the PHILIPPINES, coffee is made after the French and American fashion.



## CHAPTER XXXV

### THE EVOLUTION OF COFFEE APPARATUS

THE DEVELOPMENT OF COFFEE-ROASTING, COFFEE-GRINDING, COFFEE-MAKING, AND COFFEE-SERVING DEVICES FROM THE EARLIEST TIME TO THE PRESENT DAY—THE ORIGINAL COFFEE GRINDER, THE FIRST COFFEE ROASTER, AND THE FIRST COFFEE POT—THE ORIGINAL FRENCH DRIP POT—HOW THE COMMERCIAL COFFEE ROASTER WAS DEVELOPED—HOW THE GAS ROASTER WAS DEVELOPED IN FRANCE, GREAT BRITAIN, AND THE UNITED STATES—LATER U. S. PATENTS

IN its earliest use by man—that is, in Ethiopia, about A. D. 800—coffee was looked upon as a food. The whole ripe berries, beans and hulls, were crushed in a mortar, and molded into food balls held in shape with fat. Later, the dried berries were similarly treated, the primitive stone mortar and pestle constituting the original coffee grinder.

The dried hulls and green beans were first roasted, some time between 1200 and 1300, in crude burnt clay dishes or in stone vessels, over open fires. These were the original roasting utensils.

Next, the coffee beans were ground between little millstones, one turning above the other. Then came the mill used by the Greeks and Romans for grain. This mill consisted of two conical mill stones, one hollow and fitted over the other, specimens of which have been found in Pompeii. The idea is the same as that employed in the most modern metal grinder.

Between 1400 and 1500, individual earthenware and metal coffee-roasting plates appeared. These were circular, from four to six inches in diameter, about  $\frac{1}{16}$  inch thick, slightly concave and pierced with small holes, something like the modern kitchen skimmer. They were used in Turkey and Persia for roasting a few beans at a time over braziers (open pans, or basins, for holding live coals). The braziers were usually mounted on feet and richly ornamented.

About the same time we notice the first appearance of the familiar Turkish pocket

cylinder coffee mill and the original Turkish *ibrik*, or coffee boiler, made of metal. Little drinking cups of Chinese porcelain completed the service.

The original coffee boilers were not unlike the English ale mug with no cover, smaller at the top than at the bottom, fitted with a grooved lip for pouring, and a long straight handle. They were made of brass, and in sizes to hold from one to six tiny cupfuls. A later improvement was of the ewer design, with bulbous body, collar top, and cover.

The Turkish coffee grinder seems to have suggested the individual cylinder roaster which later (1650) became common, and from which developed the huge modern cylindrical commercial roasting machines.

The individual coffee service of early civilization first employed crude clay bowls or dishes for drinking; but as early as 1350, Persian, Egyptian, and Turkish ewers, made of pottery, were used for serving. In the seventeenth century, ewers of similar pattern, but made of metal, were the favorite coffee-serving devices in oriental countries and in western Europe.

Between 1428 and 1448, a spice grinder standing on four legs was invented; and this was later used for grinding coffee. A drawer to receive the ground coffee was added in the eighteenth century.

Between 1500 and 1600, shallow iron dippers with long handles and foot-rests, designed to stand in open fires, were used in Bagdad, and by the Arabs in Mesopotamia, for roasting coffee. These roasters





THE OLDEST COFFEE GRINDER

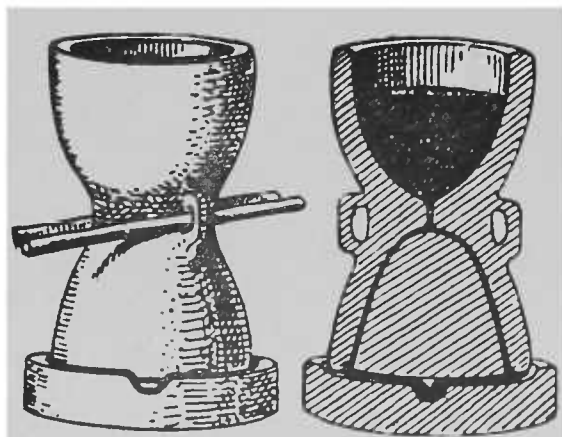
Ancient Egyptian mortar and pestle, probably used for pounding coffee.

had handles about thirty-four inches long, and the bowls were eight inches in diameter. They were accompanied by a metal stirrer (spatula) for turning the beans.

Another type of roaster was developed about 1600. It was in the shape of an iron spider on legs, and was designed, like that just described, to sit in open fires. At this period pewter serving pots were first used.

Between 1600 and 1632, mortars and pestles of wood, iron, brass, and bronze came into common use in Europe for braying the roasted beans. For several centuries, coffee connoisseurs held that pounding the beans in a mortar was superior to grinding in the most efficient mill. Peregrine White's parents brought to America on the *Mayflower*, in 1620, a wooden mortar and pestle that were used for braying coffee to make coffee "powder."

When La Roque speaks of his father bringing back to Marseilles from Constantinople in 1644 the instruments for making coffee, he undoubtedly refers to the indi-



GRAIN MILL OF GREEKS AND ROMANS

Also used for grinding coffee.

vidual devices which at that time in the Orient included the roaster plate, the cylinder grinder, the small long-handled boiler, and *fenjeyns* (fin-djans), the little porcelain drinking cups.

When Bernier visited Grand Cairo about the middle of the seventeenth century, in all the city's thousand-odd coffee houses he found but two persons who understood the art of roasting the bean.

About 1650, there was developed the individual cylinder coffee roaster made of metal, usually tin plate or tinned copper, suggested by the original Turkish pocket grinder. This was designed for use over open fires in braziers. There appeared about this time also a combined making-and-serving metal pot which was undoubt-



THE FIRST COFFEE ROASTER, ABOUT 1400

edly the original of the common type of pot that we know today.

There appeared in England about 1660, Elford's white iron machine (sheet iron coated with tin) which was "turned on a spit by a jack."<sup>1</sup> This was simply a larger



THE FIRST CYLINDER ROASTER, ABOUT 1650

size of the individual cylinder roaster, and was designed for family or commercial use. Modifications were developed by the French and Dutch. In the seventeenth century the Italians produced some beautiful designs in wrought-iron coffee roasters.

Before the advent of the Elford machine, and indeed, for two centuries thereafter, it was the common practice in the home to roast coffee in uncovered earthenware tart dishes, old pudding pans, and frying pans. Before the time of the modern kitchen stove, it usually was done over charcoal fires without flame.

The improved Turkish combination coffee grinder with folding handle and cup

<sup>1</sup> A mechanical contrivance that took the place of a boy.



## HISTORICAL RELICS IN THE PETER COLLECTION, UNITED STATES NATIONAL MUSEUM

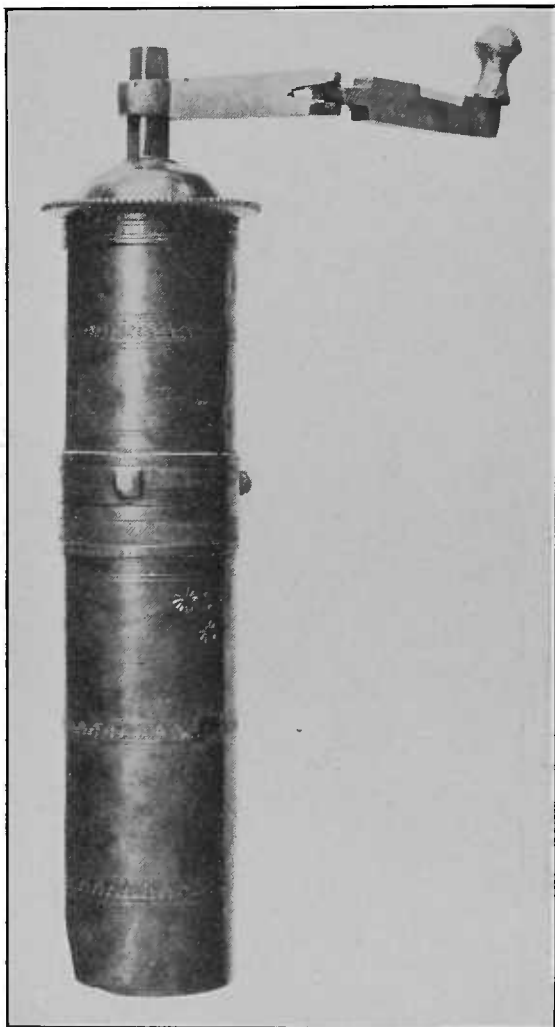
1—Bagdad coffee-roasting pan and stirrer. 2—Iron mortar and pestle used for pounding coffee. 3—Coffee mill used by General and Mrs. Washington. 4—Coffee-roasting pan used at Mt. Vernon. 5—Bagdad coffee pot with crow-bill spout.

receptacle for the beans, used for grinding, boiling, and drinking, was first made in Damascus in 1665. About this period, the Turkish coffee set, including the long-handled boiler and the porcelain drinking cups in brass holders, also came into vogue.

In 1665, Nicholas Book, "living at the Sign of the Frying Pan in St. Tulies street," London, advertised that he was "the only known man for making of mills for grinding of coffee powder, which mills are sold by him from forty to forty-five shillings the mill."

By combining the long-handle idea contained in the Bagdad roaster with that of the original cylinder roaster, the Dutch perfected a small, closed, sheet-iron cylinder-roaster with a long handle that permitted

its being held and turned in open fire places. From 1670, and well into the middle of the nineteenth century, this type of family roaster enjoyed great favor in Holland, France, England, and the United States, more especially in the country districts. The museums of Europe and the United States contain many specimens. The iron cylinder measured about five inches in diameter, and was from six to eight inches long, being attached to a three or four foot iron rod provided with a wooden handle. The green coffee was put into the cylinder through a sliding door. Balancing the roaster over a blaze by resting the end of the iron rod projecting from the far end of the roasting cylinder in a hook of the usual fire-place crane, the



**TURKISH COFFEE MILL**

A fine specimen in the Peter collection, United States National Museum.

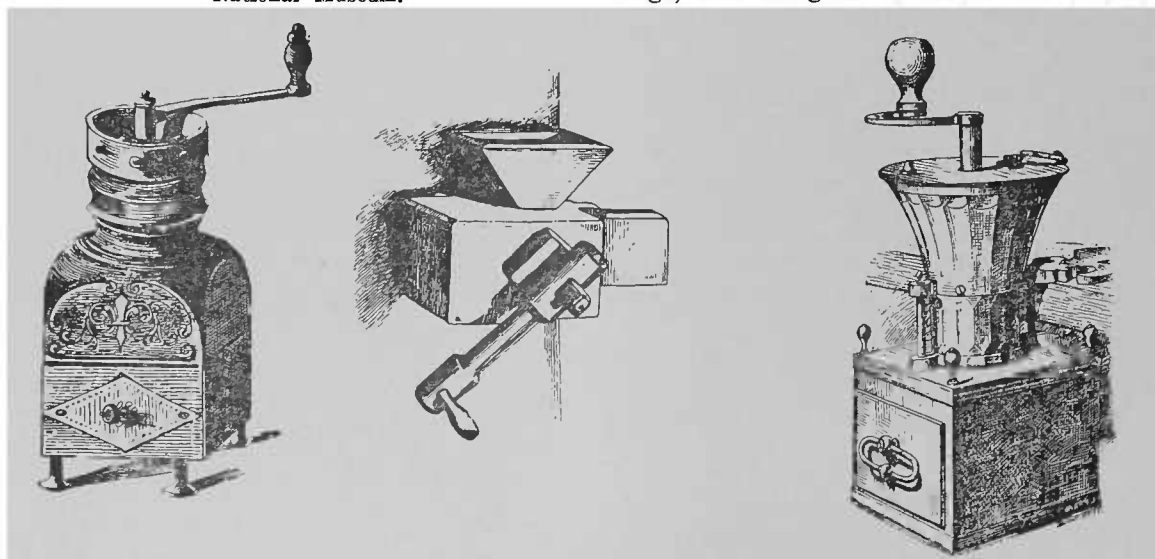
housekeeper was wont slowly to revolve the cylinder until the beans had turned the proper color.

Portable coffee-making outfits to fit the pocket were much in vogue in France in 1691. These included a roaster, a grinder, a lamp, the oil, cups, saucers, spoons, coffee, and sugar. The roaster was first made of tin plate or tinned copper; but for the aristocracy silver and gold were used. In 1754, a white-silver coffee roaster eight inches long and four inches in diameter was mentioned among the deliveries made to the army of the king at Versailles.

Humphrey Broadbent, "the London coffee man," wrote in 1722:

I hold it best to roast coffee berries in an iron vessel full of little holes, made to turn on a spit over a charcoal fire, keeping them continually turning, and sometimes shaking them that they do not burn, and when they are taken out of the vessel, spread 'em on some tin or iron plate 'till the vehemency of the heat is vanished; I would recommend to every family to roast their own coffee, for then they will be almost secure from having any damaged berries, or any art to increase the weight, which is very injurious to the drinkers of coffee. Most persons of distinction in Holland roast their own berries.

Between 1700 and 1800, there was developed a type of small portable household stove to burn coke or charcoal, made of iron, and fitted with horizontal revolving cylinders for coffee roasting. These were provided with iron handles for turning. A modification of this type of roaster under a three-sided hood, and standing on three legs, was designed to sit on the hearth of



**EARLY FRENCH WALL AND TABLE GRINDERS**

*Left*, seventeenth-century coffee grinder in the Musée de la Porte de Hal—*Center*, wall mill, eighteenth century—*Right*, iron mill, eighteenth century.



BRONZE AND BRASS MORTARS OF THE SEVENTEENTH CENTURY USED FOR MAKING COFFEE POWDER  
*Left, bronze (Germany)—Center, brass (England)—Right, bronze (Holland, 1632).*

open fire-places, close to the fire or in the smoldering ashes. Because of its greater capacity, it was probably used in the inns and coffee houses for roasting large batches. Still another type, which made its appearance late in the eighteenth century, was the sheet-iron roaster suspended at the top of a tall, iron, box-like compartment, or stove, in which the fire was built. This, too, was designed to roast coffee in comparatively large quantities. In some examples it was provided with legs.

Great silver coffee pots, "with all the utensils belonging to them of the same metal," were first used by Pascal at St.-Germain's fair in Paris in 1672. It remained for the English and American silversmiths to produce the most beautiful forms of silver coffee pots; and there are some notable collections of these in England and the United States.

The oriental serving pot was nearly always of metal, tall, and, in old models, of graceful curve, with a slightly twisted ornamental beak in the form of an S, attached below the middle of the vessel. A handle ornamented in the same way formed a decorative balance.

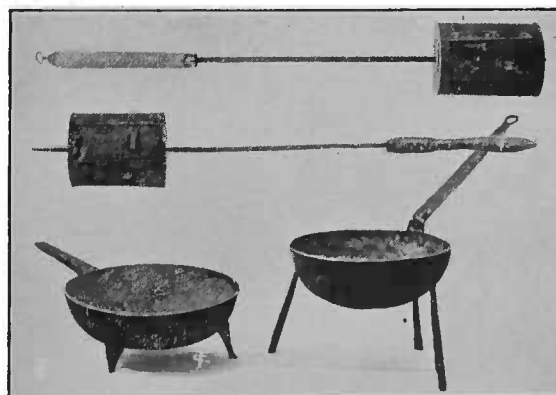
In 1692, the lantern straight-line coffee serving pot with true cone lid, thumb-piece, and handle fixed at right angle to the spout, was introduced into England, succeeding the curved oriental serving pot. In 1700, coffee pots made of cheaper metals, like tin and Britannia ware, began to appear on the home tables of the people. In 1701, silver coffee pots appeared in England hav-

ing perfect domes and bodies less tapering. Between 1700 and 1800, silver, gold, and delicate porcelain serving pots were the vogue among European royalty.

In 1704, Bull's machine for roasting coffee was patented in England. This probably marks the first use of coal for commercial roasting.

In 1710, the popular coffee roaster in French homes was a dish of varnished earthenware. This same year a novelty was introduced in France in the shape of a fustian (linen) bag for infusing ground coffee.

By 1714, the thumb-piece on English serving pots had disappeared, and the handle was no longer set at a right angle to the spout. English coffee-pot bodies showed a further modification in 1725, the taper becoming less and less.



EARLY AMERICAN COFFEE ROASTERS

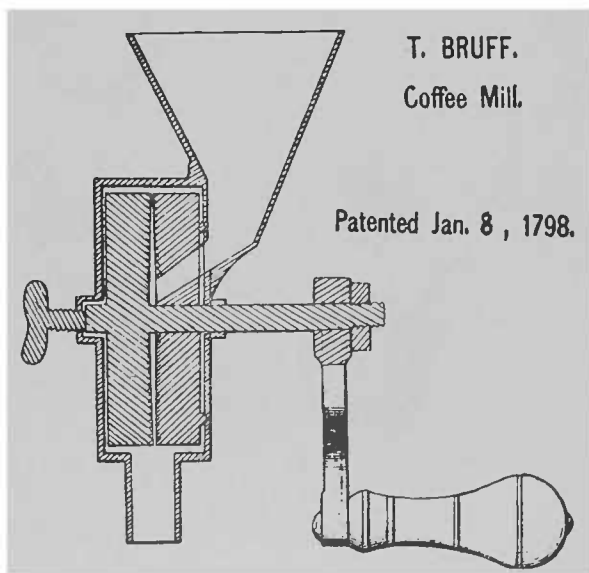
Both the cast-iron spiders and the long-handled roasters were used in open fireplaces previous to 1770.

Coffee grinders were so common in France in 1720 that they were to be had for a dollar and twenty cents each. Their development by the French had been rapid from the original spice grinder. At first, they were known as coffee mills; but in the eighteenth century, roasters came to be known by that name. They were made of iron, retaining the same principle of the horizontal mill-stones—one of which is fixed while the other moves—that the ancients employed for grinding wheat. They were squat, box-shaped affairs, having in the center a shank of iron that revolved upon a fixed, corrugated iron plate. There was also the style that fastened to the wall. At first, the drawer to receive ground coffee was missing, but this was supplied in later types. Before its invention, the ground coffee was received in a sack of greased leather, or in one treated on the outside with beeswax—probably the original of the duplex paper bag for conserving the flavor.

The French brought their innate artistic talents to bear upon coffee grinders, just as they did upon roasters and serving pots. In many instances they made the outer parts of silver and of gold.

By 1750, the straight-line serving pot in England had begun to yield to the reactionary movement in art favoring bulbous bodies and serpentine spouts.

About 1760, French inventors began to devote themselves to improvements in coffee-making devices. Donmartin, a Paris



FIRST UNITED STATES COFFEE GRINDER PATENT



ROASTING, MAKING, AND SERVING DEVICES  
Early seventeenth century, as pictured by Dufour.

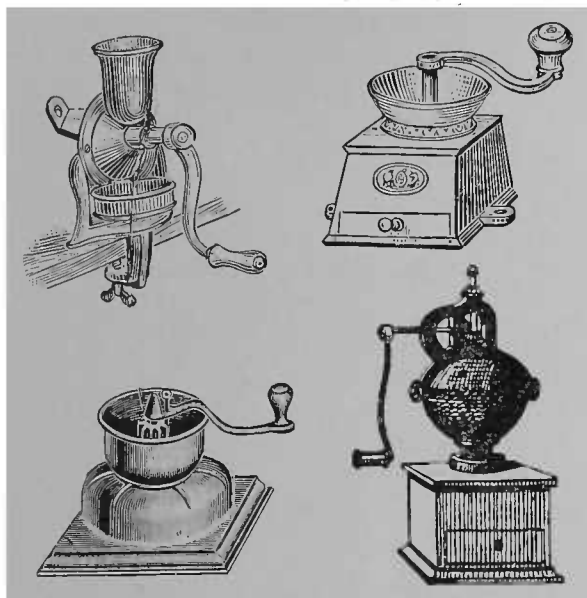
tinsmith, in 1763, invented an urn pot that employed a flannel sack for infusing. Another infusion device, produced the same year by L'Aine, also a tinsmith of Paris, was known as a *diligence*.

A complete revolution in the style of English serving pots took place in 1770, with a return to the flowing lines of the Turkish ewer; and between 1800 and 1900, there was a gradual return to the style of serving pot having the handle at a right angle to the spout.

About the time that Brazil began the active cultivation of coffee, William Panter was granted the first English patent on a "mill for husking coffee." This was in 1775.

In 1779, Richard Dearman was granted an English patent on a new method of making mills for grinding coffee. In 1798, the first American patent on an improved coffee grinding mill was granted to Thomas Bruff, Sr. It was a wall mill, fitted with





ENGLISH AND FRENCH COFFEE GRINDERS  
Nineteenth century.

iron plates, in which the coffee was ground between two circular nuts, three inches broad and having coarse teeth around their centers and fine shallow teeth at the edges.

#### *The Original French Drip Pot*

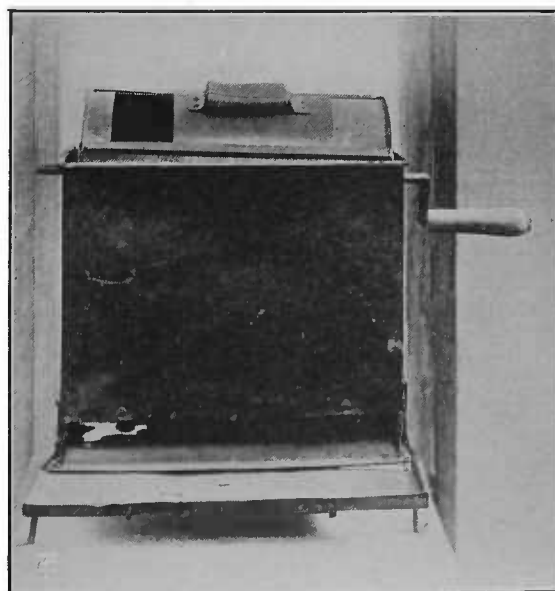
De Belloy's (or Du Belloy's) coffee pot appeared in Paris about 1800. It was first made of tin; but later, of porcelain and silver—the original French dip pot. This device was never patented; but it appears to have furnished the inspiration for many inventors in France, England, and the United States. The first French patent on a coffee maker was granted to Denobe, Henrion, and Rouch in 1802. It was for a "pharmacological-chemical coffee-making device by infusion." Charles Wyatt obtained a patent the same year in London on an apparatus for distilling coffee. The De Belloy pot is illustrated on page 582.

In 1806, Hadrot was granted a French patent on a device "for filtering coffee without boiling and bathed in air." This use of the word filtering was misleading, as it was many times after in French, English, and American patent nomenclature, where it often meant percolation or something quite different from filtration. True percolation means to drip through fine interstices of china or metal. Filtration means to drip through a porous substance, usually cloth or paper. De Belloy's pot was a percolator. So was Hadrot's. The im-

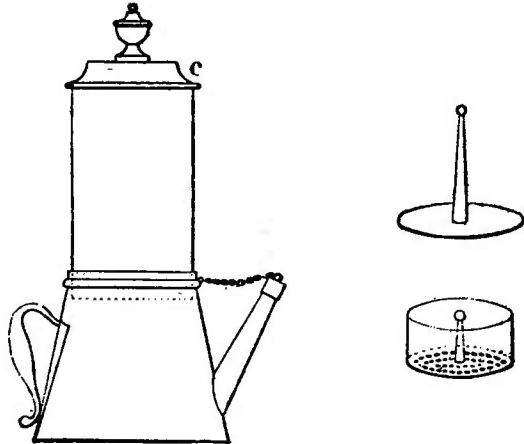
provement on which Hadrot got his patent was to "replace the white iron filter (sic) used in ordinary filtering pots by a filter composed of hard tin and bismuth" and to use "a rammer of the same metal, pierced with holes." The rammer was designed to press down and to smooth out the powdered coffee in an even and uniform fashion. "It also," says Hadrot in his specification, "stops the derangement which boiling water poured from a height can produce. It is held by its stem a half inch from the surface of the powder so that it receives only the action of the water which it divides and facilitates thus the extraction which it must produce in each of the particles."

James Henckel was granted an English patent, in 1806, on a coffee drier, "an invention communicated to him by a certain foreigner."

A coffee percolator was invented in Paris about 1806 by Benjamin Thompson, F.R.S., an American-British scientist, philanthropist, and administrator. He was known as Count Rumford, a title bestowed on him by the Pope. Rumford's invention was first given to the public in London in 1812. He has gained great credit for his device, because of an elaborate essay that he wrote on it in Paris under the title of *The excellent qualities of coffee and the art of making it in the highest perfection*, and that he caused to be published in London in



EIGHTEENTH-CENTURY COFFEE ROASTER  
Essex Institute, Salem, Mass.



THE ORIGINAL FRENCH DRIP POT  
*Cafetière à la De Belloy.*

1812. It was a simple percolator pot provided with a hot-water jacket, and was a real improvement on the French drip or percolator coffee pot invented by De Belloy, but not at all unlike Hadrot's patented device. Count Rumford, however, was a picturesque character, and a good advertiser. He is generally credited with the invention of the coffee percolator; but examination of his device shows that, strictly speaking, the De Belloy pot was just as much a percolator, and apparently antedated it by about six years.

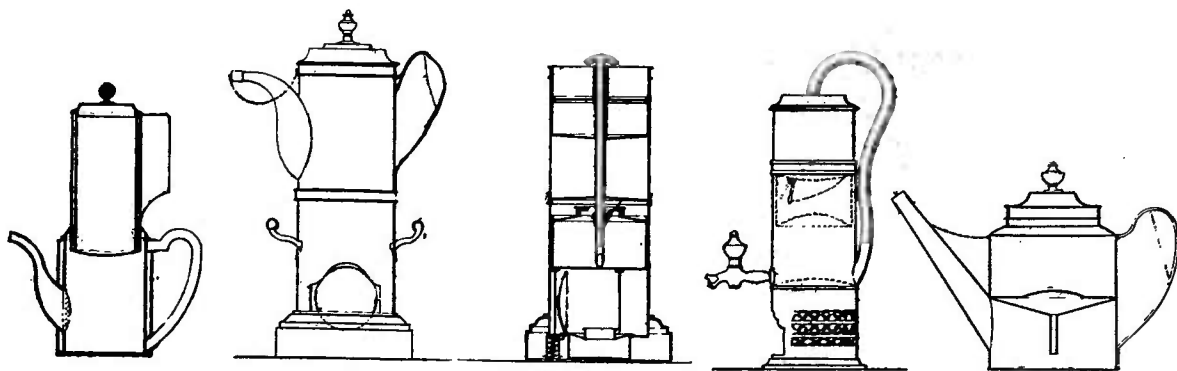
De Belloy employed the principle of having the boiling water drip through the ground coffee when held in suspension by a perforated metal or porcelain grid. This is true percolation. Hadrot did the same thing with the improvements noted above. Count Rumford in his essay admits that this method of making coffee was not new, but claims his improvement was. This was to provide a rammer for compressing the ground coffee in the upper or percolating

device into a definite thickness, this being accomplished by providing the perforated circular tin disk water-spreader that rested on the ground coffee with four projections, or feet, that kept the spreader within half an inch of the grid holding the powder in suspension and free from "agitation."

His argument was that two-thirds of an inch of ground coffee should be leveled and compressed into a half-inch thickness before the boiling water was introduced. Practically the same result was achieved in the De Belloy and Hadrot pots, also provided with water-spreaders and pluggers, but the same mathematical exactitude in the matter of the depth of the ground coffee before the percolation started was not assured. De Belloy's spreader did not have the projections on the under side upon which Count Rumford laid such stress. Then there was the hot-water jacket, which was an improvement on Hadrot's hot air bath. Inventors that followed Rumford have made light of the importance that he attached to scientific accuracy in coffee-making; but it is interesting to note how many of the features of the De Belloy, Hadrot, and Rumford pots have been retained in the modern complex coffee machines, and in most of the filtration devices.

French inventors continued to apply themselves to coffee-roasting and coffee-making problems, and many new ideas were evolved. Some of these were improved upon by the Dutch, the Germans, and the Italians; but the best work in the line of improvements that have survived the test of time was done in England and the United States.

In 1815, Sene was granted a French patent on "a device to make coffee without



PATENT DRAWINGS OF EARLY FRENCH COFFEE MAKERS

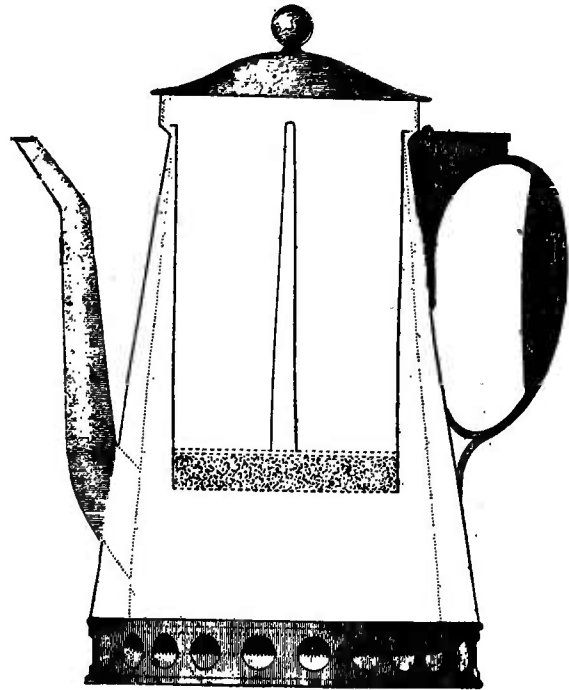
*Left*, drip pot of 1806—*Next two*, Durant's inner-tube pot, 1827—*Next (fourth)*, Gandais' first practicable pumping percolator, 1827—*Right*, Grandin & Crepeaux' percolator, 1832.

boiling." In 1819, Laurens produced the original of the percolation device in which the boiling water is raised by a tube and sprayed over the ground coffee. The same year Morize, a Paris tinsmith and lamp-maker, followed with a reversible, double drip pot which was the pioneer of all the reversible filtration pots of Europe and America. Gaudet, another tinsmith, in 1820, patented an improvement on the percolator idea, that employed a cloth filter. By 1825, the pumping percolator, working by steam pressure and by partial vacuum, was much used in France, Holland, Germany, and Austria.

Meanwhile, it was common practice to roast coffee in England in "an iron pan or in hollow cylinders made of sheet iron"; while in Italy, the practice was to roast it in glass flasks, which were fitted with loose corks. The flasks were "held over clear fires of burning coals and continually agitated." Anthony Schick was granted an English patent in 1812, on a method, or process, for roasting coffee; but as he never filed his specifications, we shall probably never know what the process was. The custom of the day in England was to pound the roasted beans in a mortar, or to grind them in a French mill.

Nathan Reed of Belfast, Me., was the first American coffee-machinery inventor. He was granted a patent on a coffee huller in 1822.

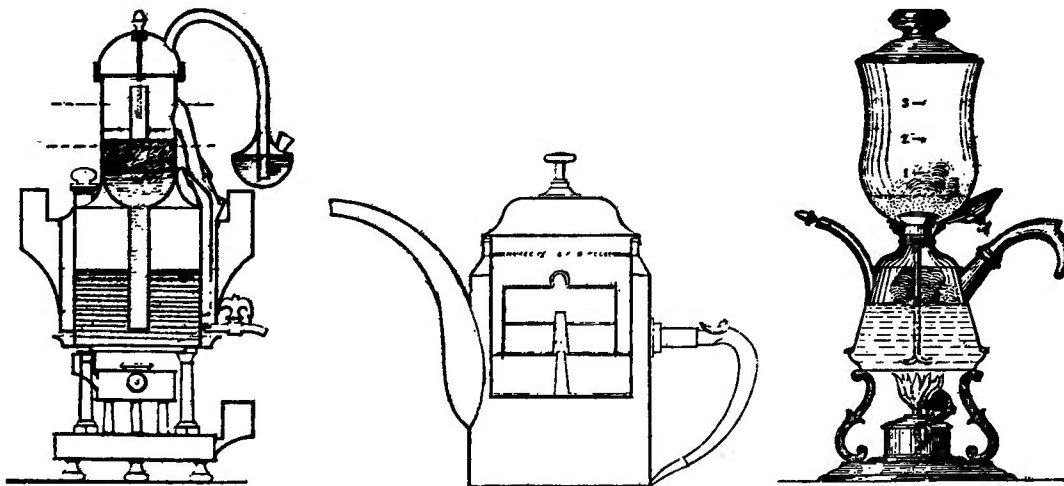
In 1822, Louis Bernard Rabaut was granted an English patent in which the French drip process was reversed by using



COUNT RUMFORD'S PERCOLATOR

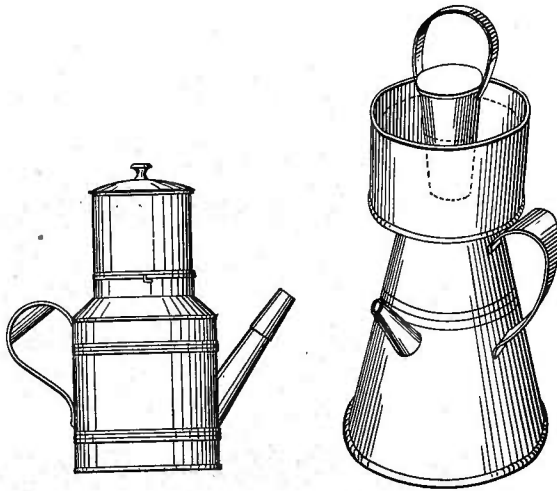
steam pressure to force the boiling water upward through the coffee mass. Casseneuve, a Paris tinsmith, seems to have patented practically the same idea in France in 1824. Casseneuve employed a paper filter in his machine.

In America, a United States patent was granted in 1813 to Alexander Duncan Moore of New Haven on a mill "for grinding and pounding coffee." This was followed by a United States patent granted to



EARLY FRENCH FILTRATION DEVICES

*Left*, Casseneuve's filter-paper machine, 1824—*Center*, Gaudet's cloth-filter pot, 1820—*Right*, Raparlier's percolator.



EARLY AMERICAN COFFEE-MAKER PATENTS  
Left, Waite & Sener's Old Dominion pot—Right, Bencini's steam condenser.

Increase Wilson, of New London, in 1818, on a steel mill for grinding coffee.

In 1815, Archibald Kenrich was granted a patent in England on "mills for grinding coffee."

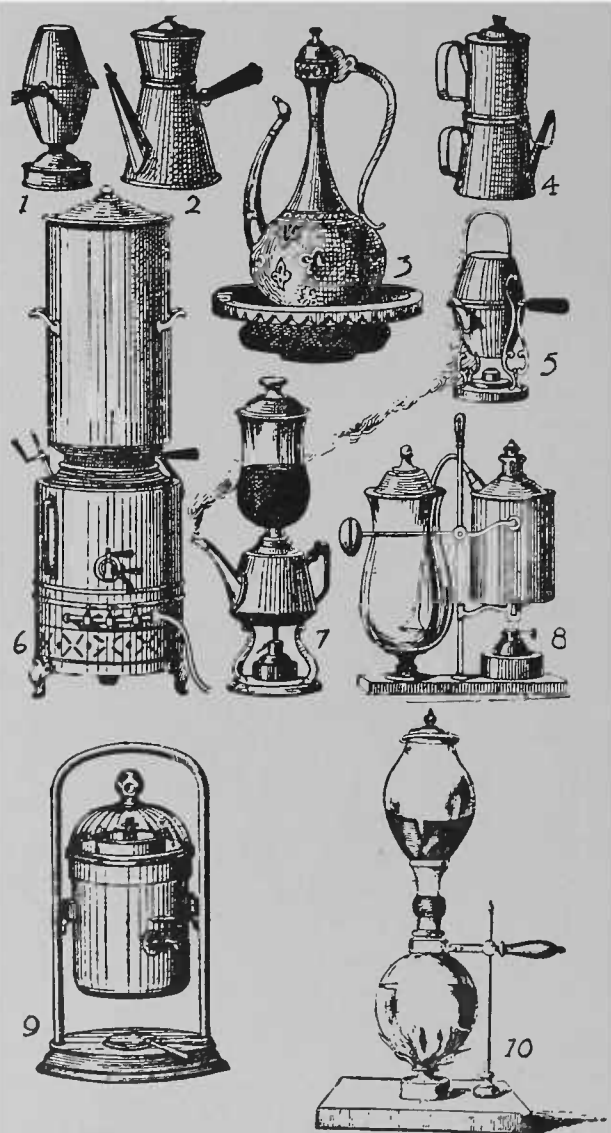
#### *The Coffee Biggin*

The coffee biggin, said to have been invented by a Mr. Biggin, came into common use in England for making coffee about 1817. It was usually an earthenware pot. At first it had in the upper part a metal strainer like the French drip pots. Suspended from the rim in later models there was a flannel or muslin bag to hold the ground coffee, through which the boiling water was poured, the bag serving as a filter. The idea was an adaptation of the French fustian infusion bag of 1711, and of other early French drip and filtration devices, and it attained great popularity. Any coffee pot with such a bag fitted into its mouth came to be spoken of as a coffee biggin. Later, there was evolved the metal pot with a wire strainer substituted for the cloth bag. The coffee biggin still retains its popularity in England.

While French inventors were busy with coffee makers, English and American inventors were studying means to improve the roasting of the beans. Peregrine Williamson, of Baltimore, was granted the first patent in the United States for an improvement on a coffee roaster in 1820. In 1824, Richard Evans was granted a patent in England for a commercial method of roasting coffee, comprising a cylindrical sheet-

iron roaster fitted with improved flanges for mixing; a hollow tube and trier for sampling coffee while roasting; and a means for turning the roaster completely over to empty it.

Roswell Abbey obtained a United States patent on a huller in 1825, and in the same year the first U. S. patent on a coffee maker was issued to Lewis Martelley of New York. It marked the first American attempt to perfect an arrangement to condense the steam and the essential oils and return them to the infusion. In 1838, Antoni Bencini, of Milton, N. C., was granted a similar patent in the United States. Row-



FRENCH COFFEE MAKERS, NINETEENTH CENTURY  
1, 2—Improved French drip pots. 3—Persian design. 4—De Belloy pot. 5—Russian reversible pot. 6—New filter machine. 7—Glass filter pot. 8—Siphon machine. 9—Vienna Incomparable. 10—Double glass "balloon" device.

land, in 1844, and Waite and Sener, in their Old Dominion pot of 1856, tried for the same result, namely, the condensation of the steam in upper chambers.

The French meantime focused on coffee makers; and in 1827, Jacques Augustin Gandais, a manufacturer of plated jewelry in Paris, produced a really practicable pumping percolator. This machine had the ascending steam tube on the exterior. The same year, 1827, Nicholas Felix Durant, a manufacturer in Chalons-sur-Marne, was granted a French patent on a percolator employing for the first time an inner tube for spraying the boiling water over the ground coffee.

In 1828, Charles Parker, of Meriden, Conn., began work on the original Parker coffee mill, which later was to bring him fame and fortune.

The next year, 1829, the first French patent on a coffee mill was issued to Colaux & Cie. of Molsheim.

That same year, 1829, the Établissements Lauzaune, Paris, began to make hand-turned iron-cylinder coffee-roasting machines.

Zenos Bronson, of Jasper County, Ga., obtained a United States patent on a coffee huller in 1829. In the next few years many others followed.

In 1831, David Selden was granted a patent in England for a coffee-grinding mill having cones of cast iron.

The first Parker coffee-grinder patent for a household coffee and spice mill was issued in the United States in 1832 to Edmund Parker and Herman M. White of Meriden, Conn. The Charles Parker Company's business was founded the same year. In 1832 and 1833, United States patents were issued to Ammi Clark, of Berlin, Conn., also on improved coffee and spice mills for home use.

Amos Ransom, Hartford, Conn., was granted a United States patent on a coffee roaster in 1833.

The English began exporting coffee-roasting and coffee-grinding machinery to the United States in 1833-34.

John Chester Lyman, in 1834, was granted an English patent on a coffee huller employing circular wooden discs, fitted with wire teeth.

In 1835, Isaac Adams and Thomas Ditson of Boston brought out improved hullers.

It was not until 1836 that the first French patent was issued on a combined coffee-roaster-and-grinder to François René Lacoux of Paris. The roaster was made of porcelain, because the inventor believed that metal imparted a bad taste to the beans while roasting.

In 1839, James Vardy and Moritz Platow were granted an English patent on a kind of urn percolator employing the vacuum process of coffee making, the upper vessel being made of glass. The first French patent on a glass coffee-making device, using the same principle, was granted to Madame Vassieux, of Lyons, in 1842. These were the forerunners of the double glass "balloons" for making coffee which later on, in the early part of the twentieth century, attained much vogue in the United States. They were very popular in Europe until the latter part of the nineteenth century.

In 1839, John Rittenhouse, of Philadelphia, was granted a United States patent on a cast-iron mill designed to handle the problem of nails and stones in grinding coffee. His improvement was intended to prevent injury to the grinding teeth by stopping the machine.

In 1840, Abel Stillman, Poland, N. Y., was granted a United States patent on a family coffee roaster having a mica window to enable the operator to observe the coffee while roasting. (See 10, page 590.)

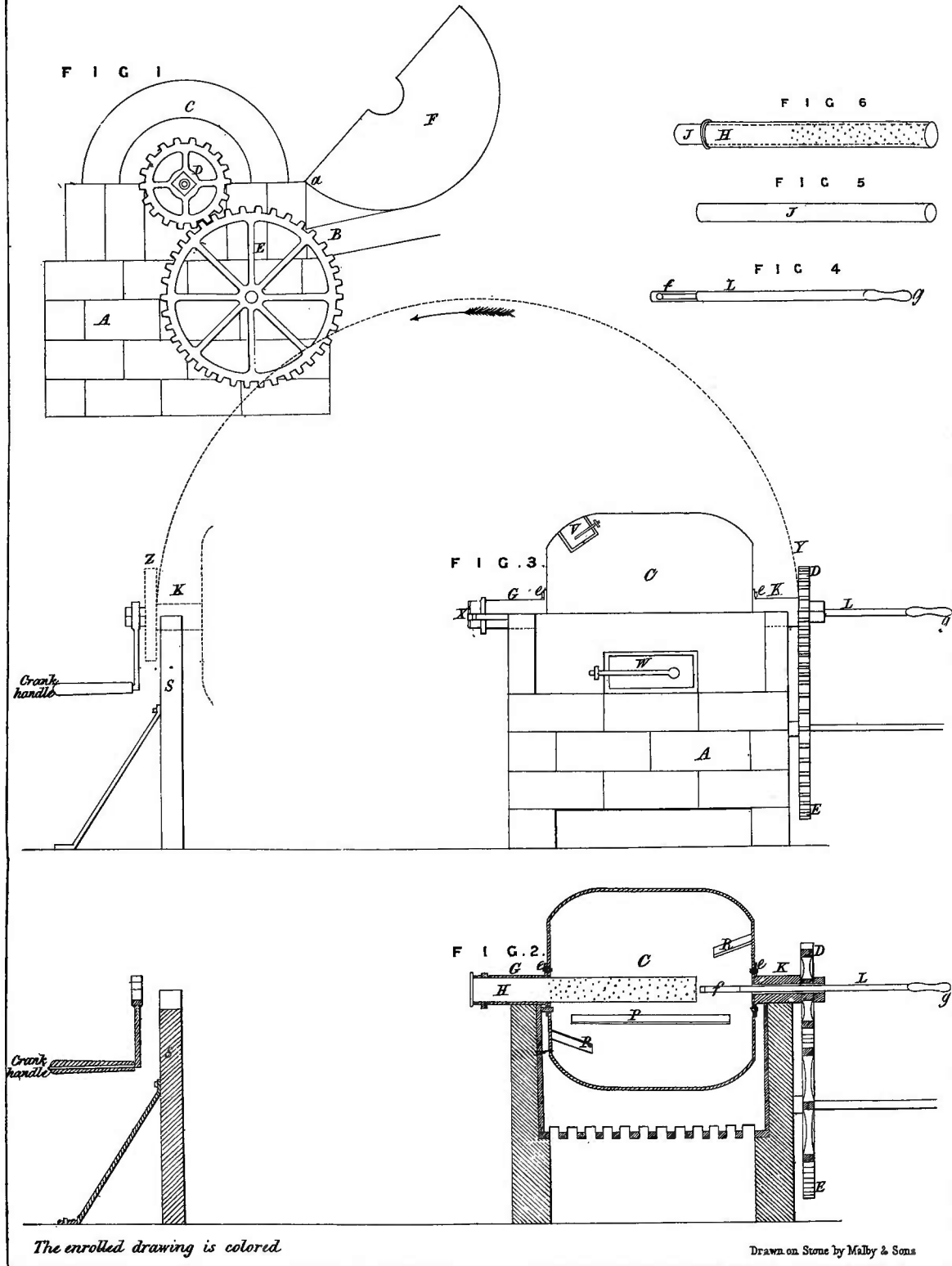
William McKinnon began, in 1840, the manufacture of coffee-plantation machinery at the Spring Garden Iron Works, founded by him in 1798 in Aberdeen, Scotland. He died in 1873; but the business continues as Wm. McKinnon & Co., Ltd.

In 1840, John Gordon & Co. began the manufacture in London of the line of plantation machinery known around the world as "Gordon make."

In 1841, William Ward Andrews was granted an English patent on an improved coffee pot employing a pump to force the boiling water upward through the coffee, which was contained in a perforated cylinder screwed to the bottom of the pot. This was Rabaut's idea of nineteen years before. We find it again repeated in the United States in a machine which appeared on the New York market in 1906.

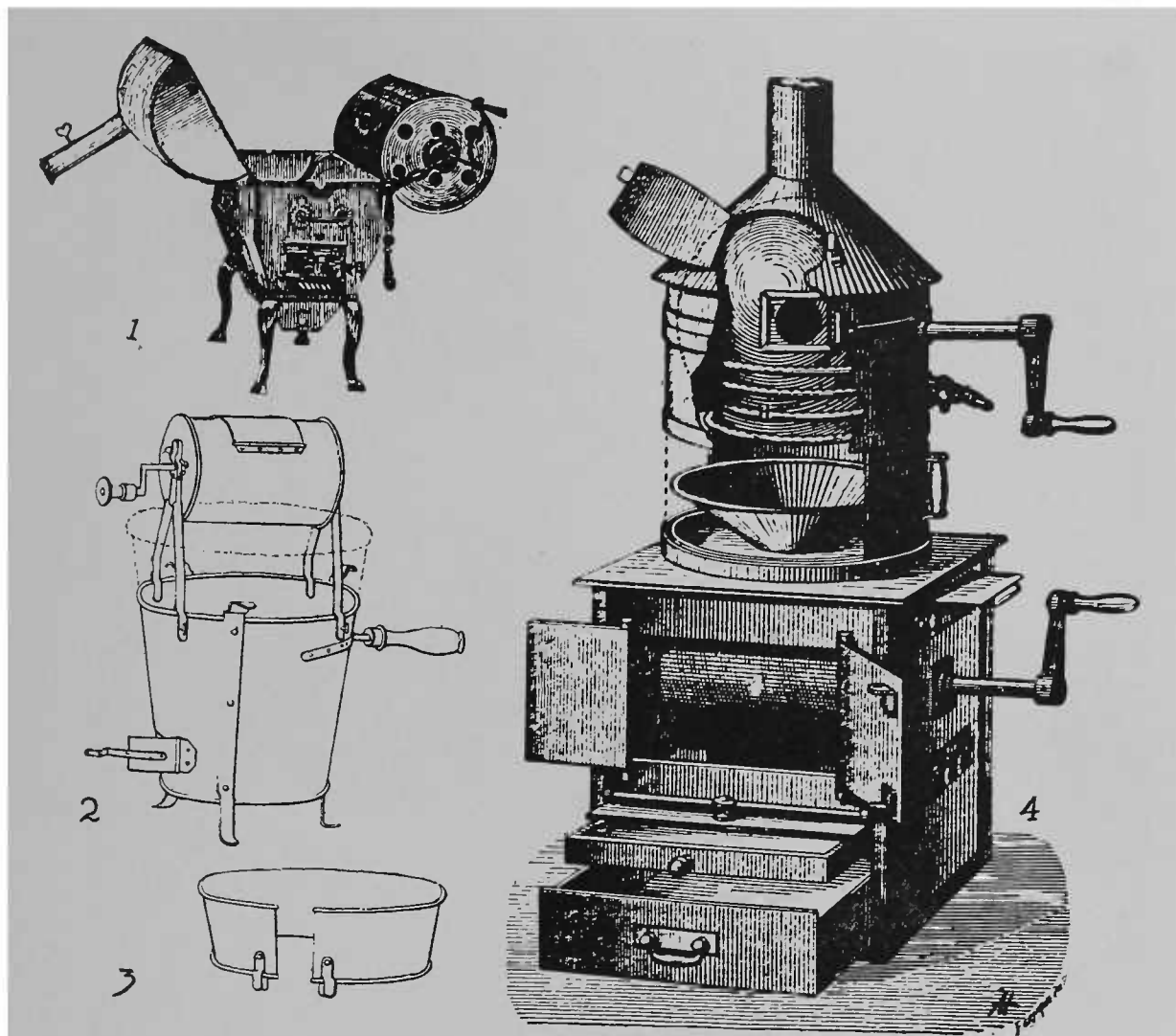
In 1841, Claude Marie Victor Bernard, of Paris, was granted a French patent on a coffee roaster, which was an improvement designed to bring the roasting cylinder and the fire in closer contact. This was accom-





FIRST BRITISH COMMERCIAL COFFEE-ROASTER PATENT, 1824

Fig. 1—End elevation. Fig. 2—Front sectional view. Fig. 3—Front elevation, showing how the roasting cylinder was turned completely over to empty. Fig. 4—The examiner, or trier. Fig. 5—Tube (J) to be inserted in H of Fig. 6 to prevent escape of aroma.



EARLY FRENCH COFFEE-ROASTING MACHINES

1—Delphine's coke machine. 2—Bernard's machine, 1841. 3—Circling for same. 4—Postular's gas machine.

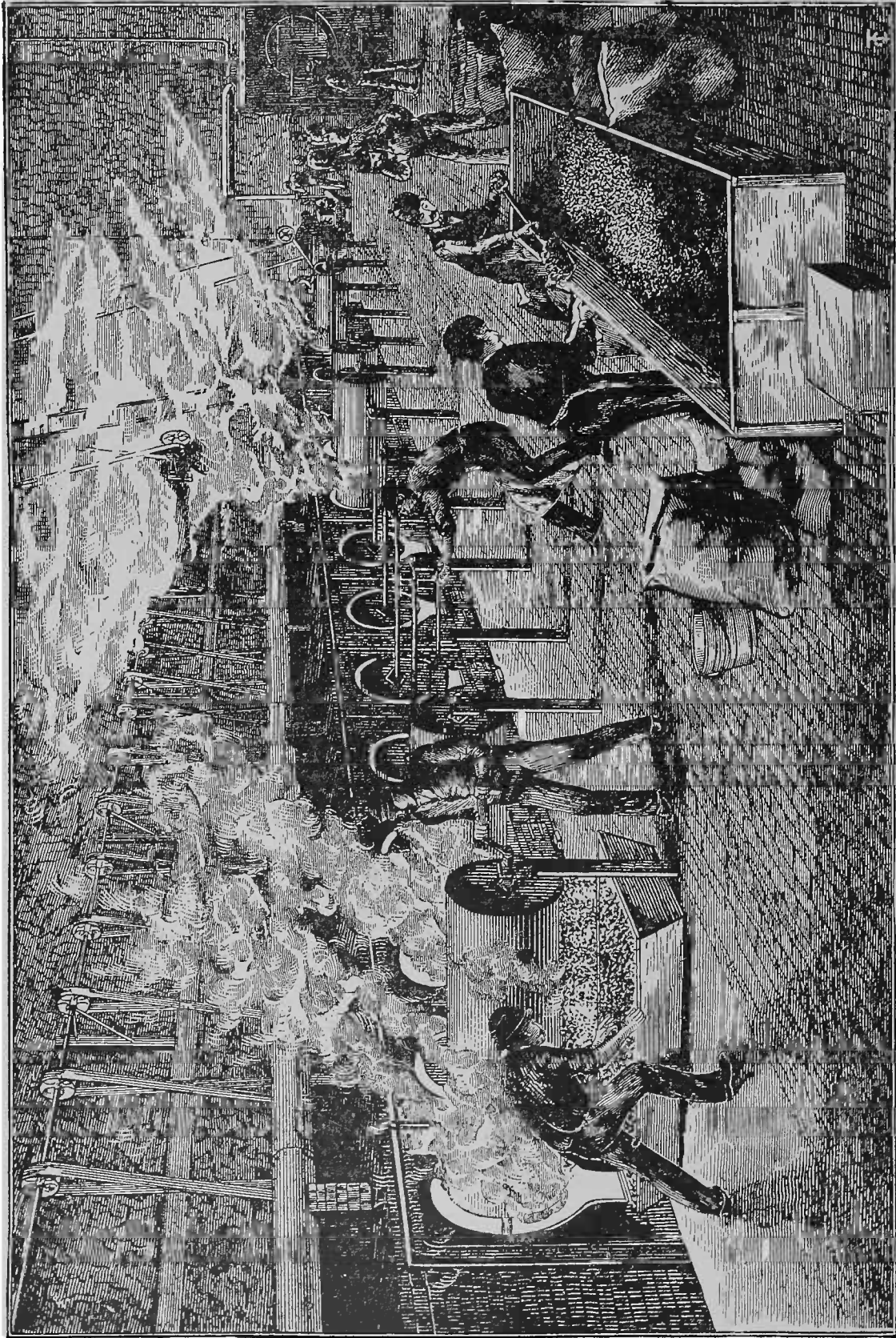
plished, to quote the quaint language of the inventor, by applying movable legs and "by superimposing a sheet iron circling around the edge of the furnace to get double the quantity of heat and it presents so much advantage that it has seemed to me worthy of being patented." (See 4, in the above illustration.)

But the French were only toying with the roaster, because roasting in France was not yet a separate branch of business, as it had become in England and the United States, where keen minds were already at work on the purely commercial coffee-roasting machine. The application of intensive thought in this direction was destined to bear fruit in America in 1846, and in England in 1847.

French inventive genius continued to occupy itself with coffee making, and in the invention of Edward Loysel de Santais, of Paris, in 1843, produced the first of the ideas that were later incorporated in the hydrostatic percolator for making "two thousand cups of coffee an hour"<sup>2</sup> at the exposition of 1855, and that has since been improved upon by the Italians in their rapid-filter machines. It should be noted that Loysel's 2,000 cups were probably demi-tasses. The modern Italian rapid-filter machine produces about 1,000 large coffee cups per hour.

James Meacock of Kingston, Jamaica, patented in England, in 1845, a self-con-

<sup>2</sup>Jardin, Edelestan. *Le Cafétier et Le Café*, Paris, 1895 (p. 290).



BATTERY OF CARTER PULL-OUT MACHINES IN AN EARLY AMERICAN PLANT

tained machine for pulping, dressing, and sorting coffee.

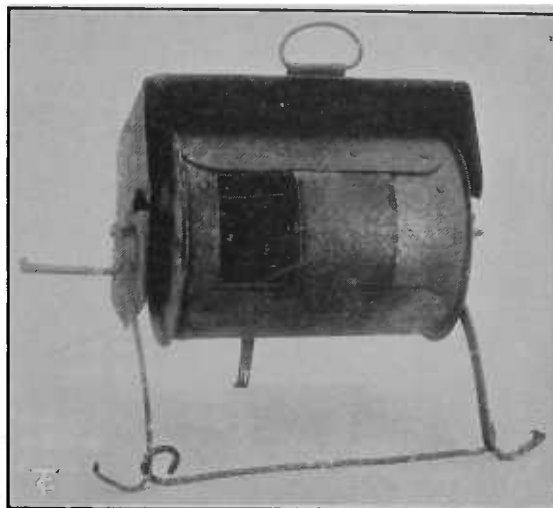
James W. Carter, of Boston, was granted a United States patent in 1846 on his "pull-out" roaster; and this was the machine most generally employed for trade roasting in America for the next twenty years. Carter did not claim to have invented the combination of cylindrical roaster and furnace; but he did claim priority for the combination, with the furnace and roasting vessel, of the air space, or chamber, surrounding it, "the same being for the purpose of preventing the too rapid escape of heat from the furnace when the air chamber's induction and eduction air openings or passages are closed."

The Carter "pull-out," was so called because the roasting cylinder of sheet iron was pulled out from the furnace on a shaft supported by standards, to be emptied or to be refilled from sliding doors in its "sides." It was in use for many years in such old-time plants as that of Dwinell-Wright Company, 25 Haverhill Street, Boston; by James H. Forbes and William Schotten in St. Louis; and by D. Y. Harrison in Cincinnati.

The picture of a roasting room with Carter machines in operation, reproduced here, recalled to the late George S. Wright, of the Dwinell-Wright Company, the scene as he saw it so many times when, as a boy of ten or twelve, he occasionally spent a day in his father's factory. "The only difference I notice," he wrote the author, "is that, according to my recollection, there was no cooler box to receive the roasted coffee, which was dumped on the floor where it was spread out three or four inches deep with iron rakes and sprinkled with a watering pot. The contact of water and hot coffee caused so much steam that the roasting room was in a dense fog for several minutes after each batch of coffee was drawn from the fire."

A. E. Forbes also thus recalled the Carter machine in his father's factory in St. Louis in 1853, when he used to help after school; and sometimes ran the roasters, after 1857:

It was barrel shaped, having a slide the full length of one side to fill and empty. A heavy shaft ran through the centre, resting on the wall of the furnace at the rear end and on an upright about eight feet from the front wall. The fire was about sixteen to eighteen inches below the



COLONIAL ROASTER WITH THREE-SIDED HOOD  
It succeeded the cast-iron spider, and was suspended from a crane, or stood in the embers.

cylinder and of soft coal. The cylinder was not perforated, the theory being to keep the vapors from escaping.<sup>3</sup> This of course was erroneous. The color of the smoke bursting from the edge of the slide was our medium of telling when the roasting process was nearing completion, and often the cylinder was pulled out and opened for inspection several times before that point was reached. When just right, the belt was shifted to a loose pulley, stopping the cylinder, which was pulled off the fire. A handle was attached to the shaft, the slide drawn, and the coffee was dumped into a wooden tray which had to be shoved under the cylinder. The coffee was stirred around in the tray until cool enough to sack.

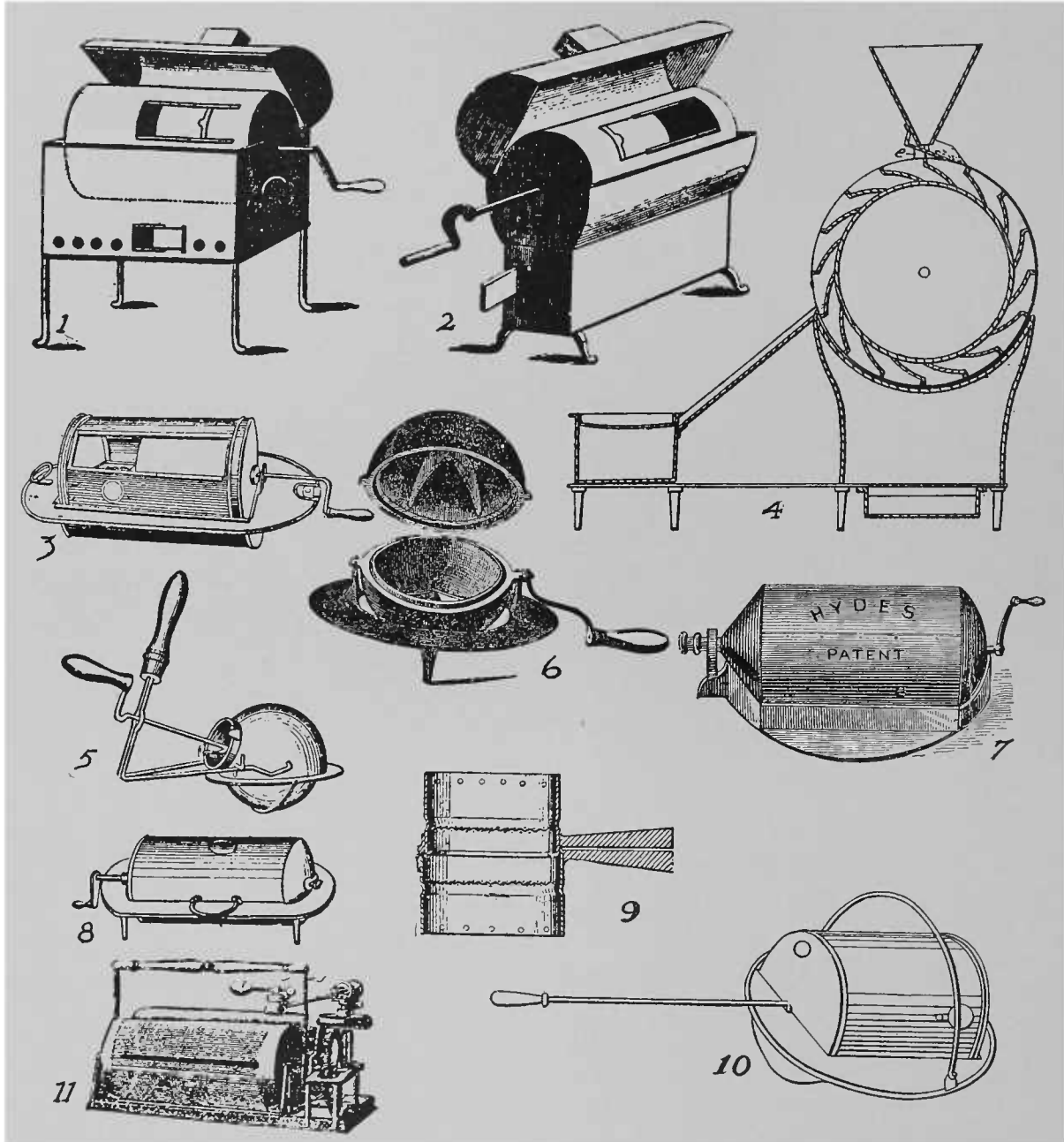
The roaster man had to be a husky in those days to pick up a sack of Rio weighing about one hundred sixty to one hundred seventy-five pounds (not a hundred and thirty-two pounds, as now) and to empty it in the cylinder. We had no overhead hoppers.

Later we built in the rear and put in two cylinders of the Chris Abele type, having stationary fronts and filling and emptying from the front end. We still used soft coal, with the fire sixteen to eighteen inches under the cylinder.

We had other machines made locally from the Carter pattern. The idea of the tight cylinder was to keep out smoke, as well as to keep in the aroma. I think we were the first to use perforations, because I remember old Jabez Burns coming along after we put in one of his machines and remarking on it.

Mr. Forbes' recollections of the early days of roasting and selling coffee at retail in St. Louis are so illuminating, and paint so interesting a picture of the period that

<sup>3</sup> In his patent specification, Mr. Carter said on this point: "Small holes should be made through the roaster in sufficient number to allow of the escape of the vapors and volatile matters which escape from the coffee while undergoing the process of being roasted."



### EARLY BRITISH AND AMERICAN COFFEE ROASTERS

1, 2—British charcoal machines. 3, 5, 8—American coal-stove roasters. 4—Remington's wheel-of-buckets (American) roaster, 1841. 6—Wood's roaster. 7—Hyde's stove-roaster. 9—Reversible stove roaster. 10—Abel Stillman's stove roaster.

they are printed here to illustrate the conditions that prevailed generally at the time when the commercial roasting machine of the United States was being developed into the modern type. He says further:

Selling roasted coffee was up-hill work, as every one roasted coffee in the kitchen oven. People were buying, say, at twenty cents. Our asking twenty-five cents "roasted" called for a lot of explanation about shrinkage, tight cylinders so

the strength and flavor could not get away, etc.; while, when they roasted a pound in the oven the flavor scented the whole house, thus losing so much strength to say nothing of the unevenness of their roasts—part raw, part roasted, producing an unpleasant taste. An occasional burned roast at home helped some. They tell of a man who, going out in the back yard and kicking over a clod by accident, uncovered some burned coffee. He called to his wife and wanted an explanation. She acknowledged she had burnt it, and hid it so he would not scold. He said, "We had better buy



it roasted in the future and avoid such accidents."

We roasted in the cellar. We had an elaborately polished Reed & Mann engine in one window, two brass hoppers in the other, and our boiler was under the sidewalk. We had a mahogany-top counter, oil paintings on the wall, and bin fronts of Chinamen, etc., done by the celebrated artist, Mat Hastings (now dead); so you see we started right.

The fight we had to introduce roasted coffee was fierce. Our argument was on the saving of fuel, labor, temper, scorched faces, and anything we could think of. We talked only three coffees, Rio, Java, and Mocha. When Santos began to come, it was hard to change them over from the rank Rio flavor to the more mild Santos. The latter they claimed did not have the rough taste. They missed it and longed for the wild tang of the Rio.

We did not import, but bought in New Orleans and from several local wholesale grocers. No one delivered. Shipments were f. o. b. St. Louis. Draying and packages were extra. Coffee was not cleaned or stoned, but was sold as it came from the sack. However, we did not use any very low grades then. If any one complained of the stones hurting their mills, we advised them to buy ground coffee, showing how it kept better ground as it was packed tight, whereas the roasted was looser and the air could get through it. It was fully a year or more before we began to sell in quantities to make it profitable. In roasting for others, we got a cent per pound; and after awhile, that became so much a business it paid all our expenses. We were the first to roast coffee by steam power west of the Mississippi and east of the Rocky Mountains.

The tea department helped us to hold out until coffee got its hold on the public; for in those

days every one used tea and insisted on having it good. Price was no object. How different now!

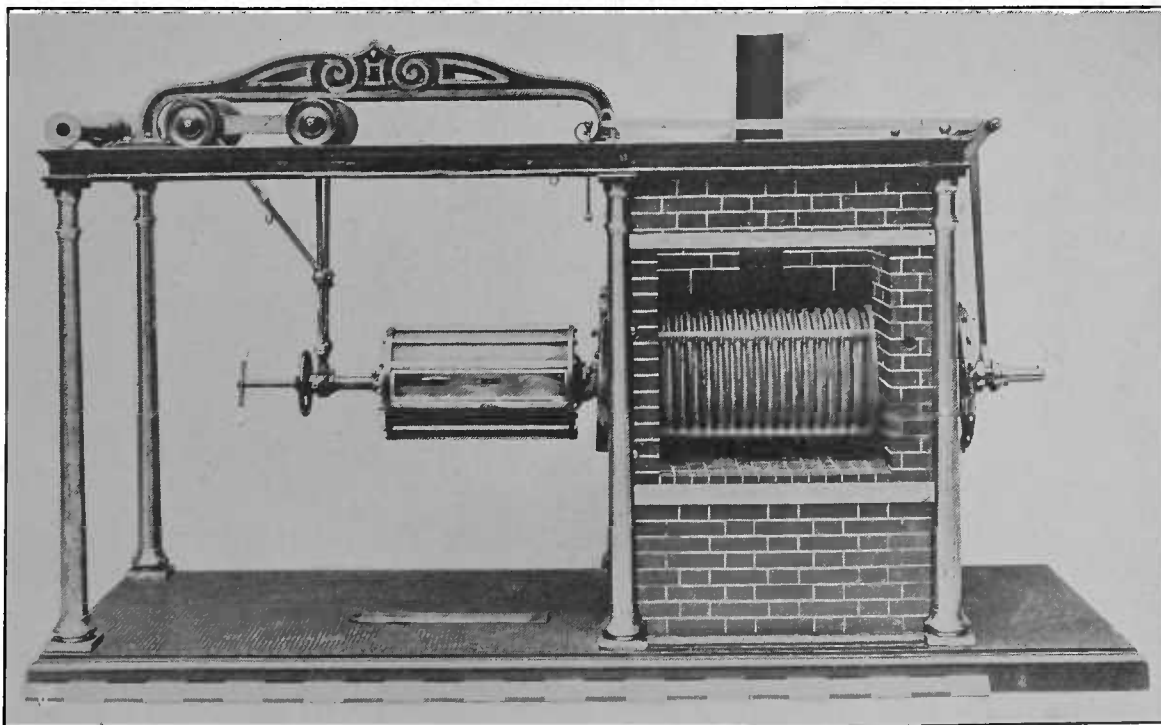
Five years later (1862) J. Nevison, an Englishman, drifted into town and opened at 85 North Fourth Street. He got out a very bombastic circular which caused us to put out one. Then came a party named Childs; and after him, Hugh Menown, grand-uncle of the present Menown, of Menown & Gregory; and Mat Hunt; all passed over to the Great Majority. After the Civil War they multiplied pretty fast, coming and going until now [1922] we have nineteen roasting establishments in the city.

The late Julius J. Schotten also wrote the author as follows concerning the days of the Carter roaster and of the wholesale coffee-roasting business founded by William Schotten in 1862:

In the early days, every wholesale grocer was selling coffee; the wholesale grocer controlled ninety per cent of the trade in the country. It did not pay the coffee roaster to have men on the road selling coffee in those days. Such being the case, seventy-five per cent of the roasting done by the coffee roasters was job roasting, at one cent a pound.

In the beginning there were only two kinds of roasted coffee known to the trade in this section of the country (St. Louis) and of course one of these brands was "Rio"—the other, "Java." The former was a genuine Rio, but the Java was mostly Jamaica coffee.

Roasted coffee then was packed (for city trade) in five and ten pound packages, and this size package seemed to supply the wants of the ordinary grocer for a week. Occasionally a twenty-



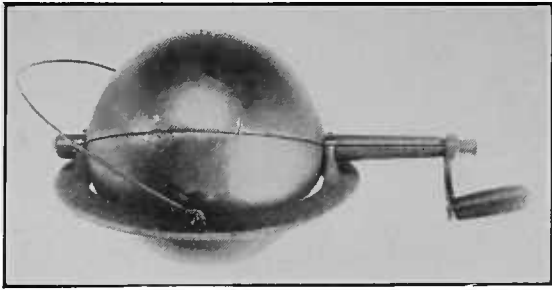
THE DAKIN ROASTING MACHINE OF 1848

five pound package, and in a few instances as much as fifty pounds of one grade was sold at a time.

The class of customers the coffee-roasters sold in those days were the smaller merchants; the larger stores, having their ideas as to quality, bought their coffees green. As they had very little sale for the roasted, they would send a half-sack, and sometimes a whole sack to have it roasted. It took a number of years to induce the larger grocers, and even the average grocers, to purchase their coffee already roasted.

Coffees were roasted in the old style, "pull-out" roaster cylinder. That is to say, it was necessary to stop the roaster and to pull out the cylinder to sample the coffee in order to know when to take the coffee off the fire. When the coffee was ready to take off, the cylinder was pulled out its entire length. It was then turned over and a slide nine inches wide, running the full length of the cylinder, was opened and the contents were dumped in the cooling box. When the coffee reached the cooling box, it took two men with hoes or wooden shovels to stir and turn it until it was properly cooled, there being no cooling arrangements then as we have nowadays.

At that time there were no stoning or separating machines; and as a bag of the ordinary



A GLOBULAR STOVE ROASTER OF 1860

green Jamaica coffee contained from three to five pounds of stones and sticks, it was necessary to hand-pick the coffee after it was roasted.

After Carter, the next United States coffee-roaster patent was granted to J. R. Remington, of Baltimore, on a roaster employing a wheel of buckets to move the green coffee beans singly through a charcoal heated trough. It never became a commercial success. (See 4, page 590.)

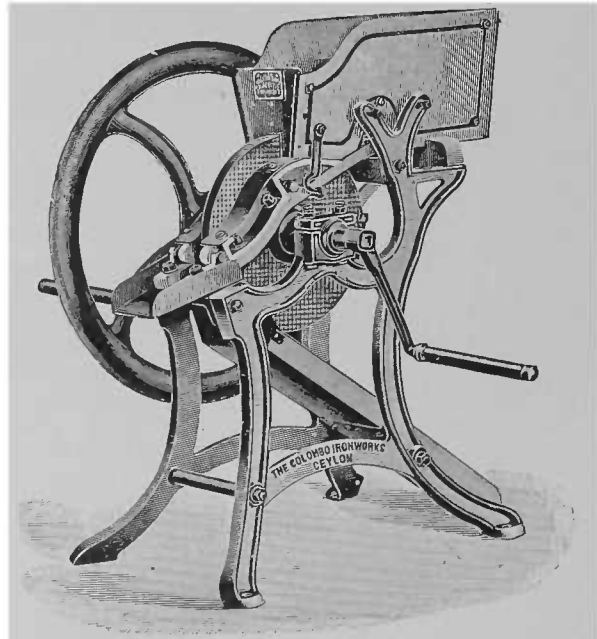
In 1847-48, William and Elizabeth Dakin were granted patents in England on an apparatus for "cleaning and roasting coffee and for making decoctions." The roaster specification covered a gold, silver, platinum, or alloy-lined roasting cylinder and traversing carriage on an overhead railway to move the roaster in and out of the roasting oven; and the "decoction" specification covered an arrangement for twisting a cloth-bag ground-coffee-container in a coffee biggin, or applied a screw mo-



COSTA RICA VERTICAL COFFEE WASHER

tion to a disk within a perforated cylinder containing the ground coffee, so as to squeeze the liquid out of the grounds after infusion had taken place.

The roaster has survived, but the coffee maker was not so fortunate. The Dakin idea was that coffee was injuriously affected by coming in contact with iron during the roasting process. The roasting cylinder was enclosed in an oven instead of being directly exposed to the furnace heat. The apparatus was provided also with a



WALKER'S ORIGINAL DISK PULPER, 1860  
Much favored in Ceylon and India.

"taster," or sampler, the first of its kind, to enable the operator to examine the roasting berries without stopping the machine. As will be seen by referring to the picture of the model (p. 591), the apparatus was ingenious and not without considerable merit. Dakin & Co. are still in existence in London, operating a machine very like the original model.

In 1848, Thomas John Knowlys was granted a patent in England on a perforated roasting cylinder coated with enamel.

It is to be noted in passing that this idea of handling the green bean with extreme delicacy, evidently obtained from the French, was never taken seriously in the United States, whose inventors chose to handle it with rough courage.

The first English patent on a coffee



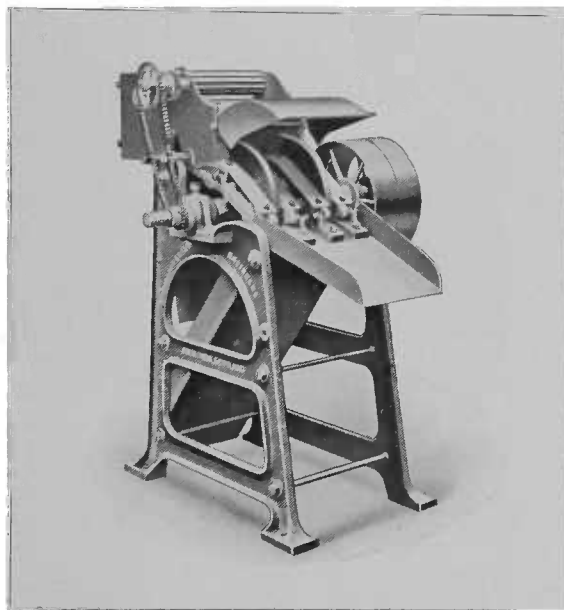
"GRANADA" UNPULPED COFFEE SEPARATOR  
Shown in combination with a Guatemala coffee pulper

grinder was granted to Luke Herbert in 1848.

In 1849, Apoleoni Pierre Preterre, of Havre, was granted an English patent on a coffee roaster mounted on a weighing apparatus to indicate loss of weight in roasting and automatically stop the roasting process. At the same time he secured an English patent on a vacuum percolator, not unlike Durant's of 1827.

In 1849 also, Thomas R. Wood, of Cincinnati, was granted a United States patent on a spherical coffee roaster for use on kitchen stoves. It attained considerable popularity among housewives who preferred to do their own roasting. (See 6, page 590.)

About 1850, John Walker, one of the pioneer English inventors of coffee-plantation machinery, brought out in Ceylon his cylinder pulper for Arabian coffee. The pulping surface was made of copper, and was pierced with a half-moon punch that raised the cut edges into half circles.

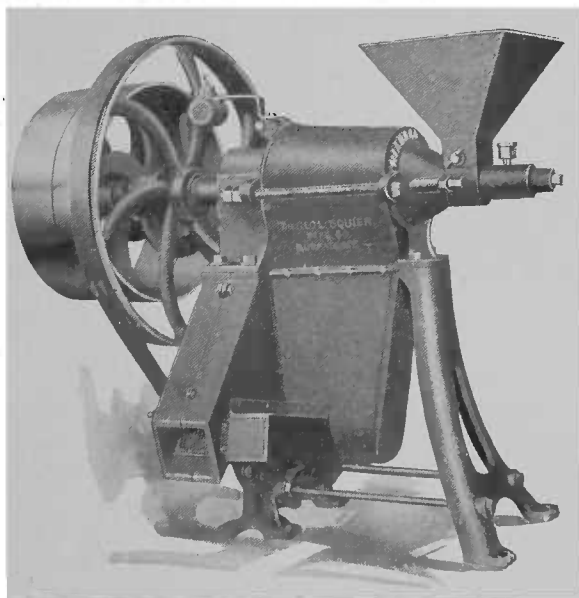


DOUBLE DISK PULPER

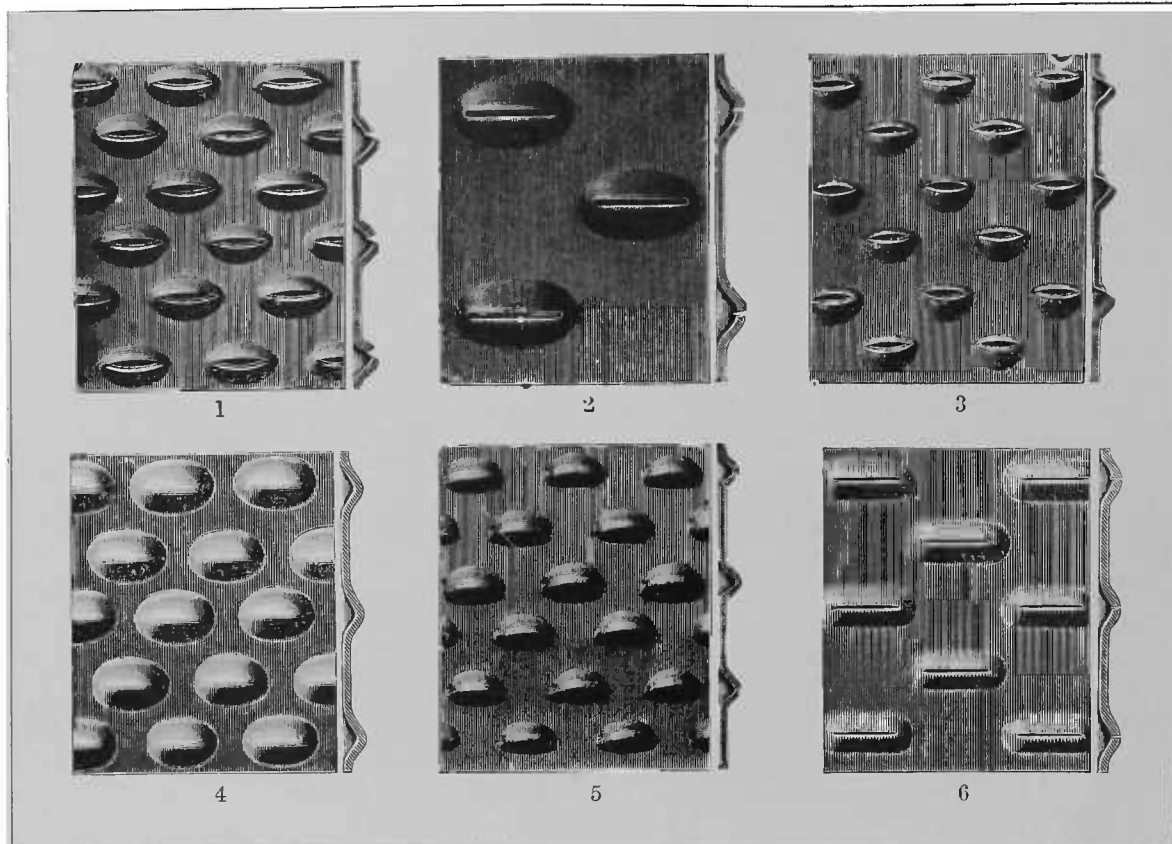
In 1852, Edward Gee secured a patent in England on a coffee roaster fitted with inclined flanges for turning the beans while roasting.

Robert Bowman Tennent obtained an English patent in 1852 and a United States patent in 1853 on a two-cylinder pulper.

C. W. Van Vliet, of Fishkill Landing, N. Y., was granted a United States patent in 1855 on a household coffee mill employing upper breaking and lower grinding cones. He assigned it to Charles Parker of Meriden, Conn. In 1859, John Gordon



"NIAGARA" POWER COFFEE HULLER



SPECIMENS OF COPPER COVERS FOR PULPER CYLINDERS

1—For Arabian coffee (*Coffea arabica*). 2—For Liberian coffee (*Coffea liberica*). 3—Also for Arabian.  
4—For *Coffea canephora*. 5—For *Coffea robusta*. 6—For larger Arabian, and for *Coffea maragogipe*.

was granted an English patent on his improved coffee pulper.

George L. Squier began the manufacture of plantation machinery in Buffalo, N. Y., in 1857. He was active in the business until 1893, and died in 1910. The Geo. L. Squier Manufacturing Co. continues as one of the leading American manufacturers of coffee-plantation machinery.

In 1860, Marcus Mason, an American mechanical engineer in San José, Costa Rica, invented a coffee pulper and cleaner which became the foundation stone of the extensive plantation-machinery business of Marcus Mason & Co., established in 1873 at Worcester, Mass.

In 1860, John Walker was granted an English patent on a disc pulper in which the copper pulping surface was punched, or knobbed, by a blind punch that raised rows of oval knobs but did not pierce the sheet, and so left no sharp edges. During Ceylon's fifty years of coffee production, the Walker machines played an important part in the industry. They are still manu-

factured by Walker, Sons & Co., Ltd., of Colombo, and are sold to other producing countries.

Alexius van Gülpen began the manufacture of a green-coffee-grading machine at Emmerich, Germany, in 1860.

Following Newell's United States patents of 1857-59, sixteen other patents were issued on various types of coffee cleaning machines, some designed for plantation use, and some for treating the beans on arrival in the consuming countries.

In 1860-61 several United States patents were granted John and Edmund Parker on coffee grinders for home use.

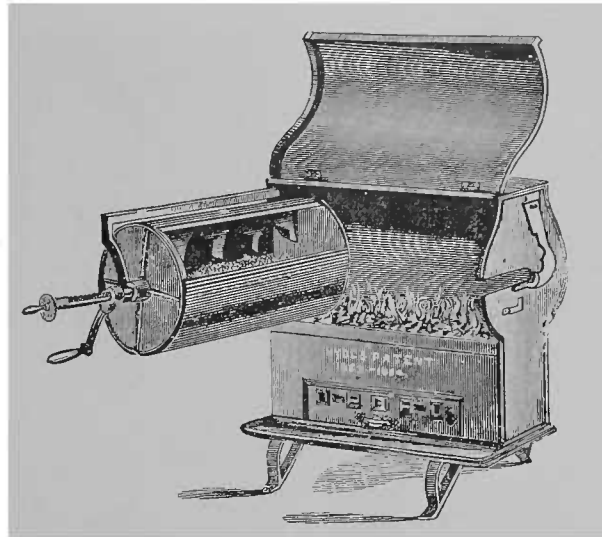
In 1862, E. J. Hyde, of Philadelphia, was granted a United States patent on a combined coffee-roaster and stove fitted with a crane on which the roasting cylinder was revolved and swung out horizontally for emptying and refilling. This machine proved to be a commercial success. Benedickt Fischer used one in his first roasting plant in New York. It is still being manufactured by the Bramhall Deane Company of New York.

*The Jabez Burns Patents*

In 1864, Jabez Burns, of New York, was granted a United States patent on the original Burns coffee roaster, the first machine which did not have to be moved away from the fire for discharging the roasted coffee, and one that marked a distinct advance in the manufacture of coffee-roasting apparatus. It was a closed iron cylinder set in brickwork. (See illustration, page 596.)

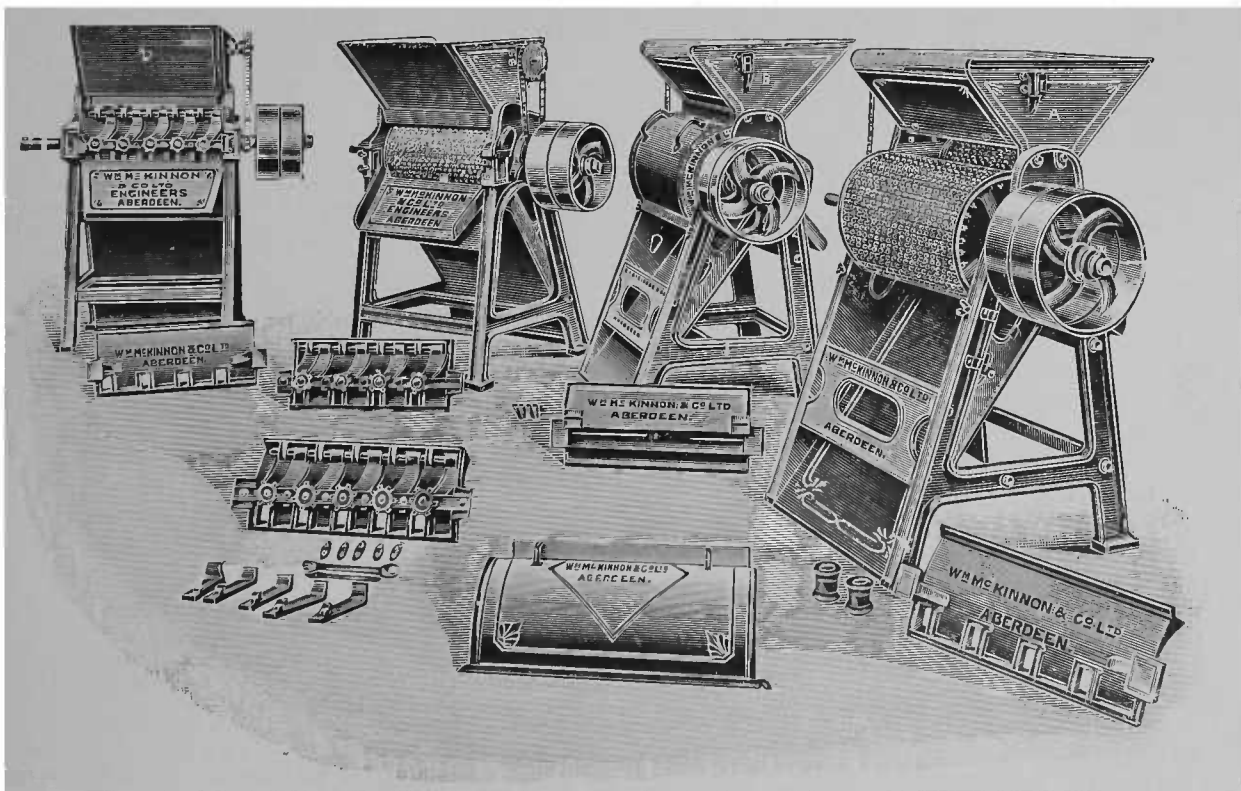
Jabez Burns had been a student of coffee roasting in New York for twenty years before he produced the machine that was to revolutionize the coffee business of the United States. He had brought with him from England a knowledge of the trade in that country, where he first began his business training by selling Java coffee at fourteen cents and Sumatra at eleven cents to hotels, boarding-houses, and private families.

Up to the time of the Civil War, the contrivances employed for roasting coffee in every case necessitated the removal of the roasting apparatus—whether pan, globe, or cylinder—from the fire. The process of causing coffee to discharge from the end of the roasting cylinder at the pleasure of the operator while the cylinder was still in



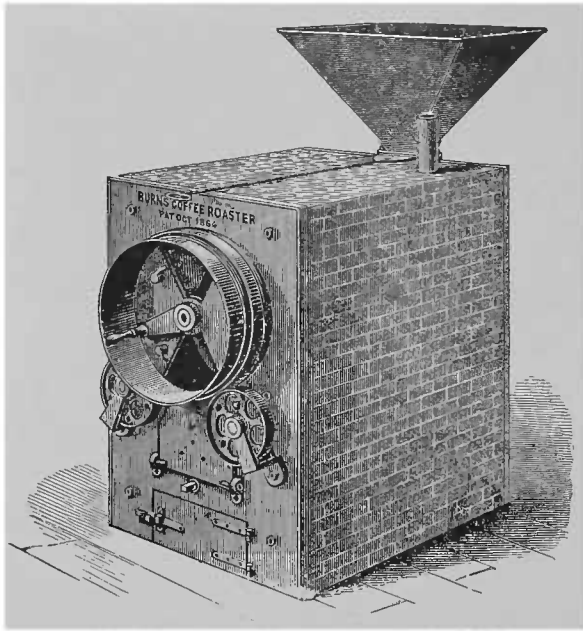
HYDE'S COMBINED ROASTER AND STOVE, 1862

motion was new; and the double set of flanges to produce this effect, and at the same time, during the process of roasting, to keep the coffee equally distributed from end to end of the cylinder, was new. Some one suggested this last improvement was simply an Archimedean screw placed in a cylinder, but Mr. Burns replied: "It is a double screw, a thing never suggested by the Archimedean screw. It is, in fact, a



GROUP OF BRITISH CYLINDER COFFEE-PULPING MACHINES





THE ORIGINAL BURNS ROASTER, 1864

double right and left augur, one within the other, firmly secured together and also to the shell or cylinder, and when the cylinder revolves the desired result is obtained—the idea being entirely original.”

Mr. Burns had watched the development of the coffee business from the time when the preparation of coffee was largely confined to the home, where the approved roasting implements were hot stones, or tiles, iron plates, skillets, and frying pans. Some of these were still in use twenty years after he produced his first machine; and he often said that coffee evenly roasted by such methods was just as good as if done by the best mechanical device ever invented. He also said: “Coffee can be roasted in very simple machinery. Some of the best we ever saw was done in a corn popper. Patent portable roasters are almost as numerous as rat traps or churns.”

He early saw the practice of domestic roasting falling into disuse, as it was becoming possible to supply the consumer with roasted coffee for only a trifle more than in the green state, with all the labor and annoyance of roasting done away with—a talking point that John Arbuckle was quick to seize upon in his first Ariosa advertising.

In almost every town of any size there were concerns engaged in the roasting business. Within a few years, Burns machines were placed in all the principal roasting centers. Pupke & Reid in New York; Flint, Evans & Co., and James H. Forbes in St.

Louis; Arbuckles & Co., in Pittsburgh; the Weikel & Smith Spice Co. in Philadelphia; Theodore F. Johnson & Co., in Newark; Evans & Walker in Detroit; W. & J. G. Flint in Milwaukee; and Parker & Harrison in Cincinnati, were among his first customers.

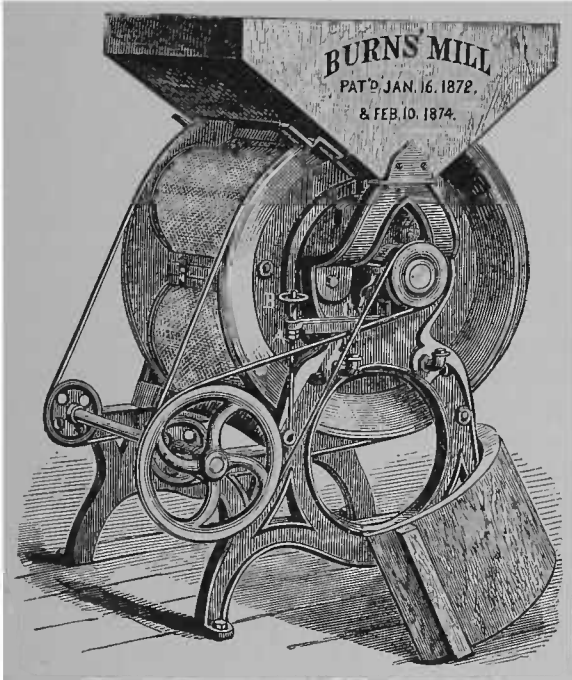
It is said that in 1845 there were facilities in and around New York to roast as much coffee as was then consumed in Great Britain. Steam power was being extensively used, and the roasting was done here for a large part of the country. The habit was to buy roasted coffee from the coffee and spice mills by the bag or larger quantity for country consumption; and the grocers and small tea stores, for local consumption, bought from twenty-five pounds upward at a time. This method cheapened the roasting of coffee to half a cent a pound; and then good profits could be made, for everything was cheap in those days. Even at that, it would have been impossible for each tea dealer to have roasted his own coffee for several times the amount, so the practice was generally adhered to all over the country.

Jabez Burns wrote in 1874:

It is preposterous to suppose that household roasting will be continued long in any part of this country, if coffee properly prepared can be had. This is demonstrated by the remarkable advances made in Pittsburgh and other places, where only a few years ago the sales were chiefly in green coffee. Now the amount roasted in Pittsburgh alone by those who make a business of it, exceeds the entire consumption of coffee of any kind in the United States fifty years ago. It will never pay for small stores to roast if the large manufactories will do the work well, and if they will not, small dealers will add proper machinery, and will eventually become strong competing dealers. By doing the work with proper care they will not only secure a reputation with large sales for themselves, but will command the roasting for other parties.

Until the Burns roaster appeared, coffee roasters were usually cylinders that revolved upon an axis; the other devices that were tried were not successful. Jabez Burns thus describes the first roaster he ever saw at Hull, England:

It consisted of a furnace, open at the top, and a perforated cylinder with a slide door. The axis, or shaft, of the cylinder had bearings on a frame which passed outside the furnace, while the cylinder went down into the fire pit, the top of which could be covered over. In this position it could be turned by means of a crank on the end of a shaft. The only means of testing was by the escape of the steam or aroma, whichever predominated, passing out through the perfora-



BURNS GRANULATING MILL, 1872-74

tions at the top; but so expert was the operator and so quick to detect the aroma, that he seldom had to return the cylinder to the fire to produce a satisfactory roast. This man roasted fifty pounds or less in a batch for a number of retail stores.

Globes, consisting of two hemispheres, made of cast iron and so arranged that they opened to fill and discharge, but operated substantially as above, only with the method of lowering into the fire changed somewhat, I have seen in use in Scotland in 1840. They were called French roasters.

In this country a few years ago the use of the long sheet-iron cylinder was almost universal, varying only in the method of placing the cylinder over the fire—some sideways on a track, others endwise, sliding on a long shaft or by turning on a crane, in either case causing considerable labor and loss of time, which often resulted in the hands of the inexperienced in more or less spoiling the batch of coffee.

From his expert knowledge of coffee and coffee-roasting problems, Jabez Burns quickly rose to a commanding position in the industry. He was a trade teacher and a trade builder. He had very definite ideas on roasting. He said:

The object of roasting is not attained until all the moisture (water of vegetation) is driven off. Roast properly—uniformly and sufficiently—and you will get all the aroma there is in the bean. Coffees of various kinds can not be roasted to a uniform color. Some will be of a light shade when sufficiently roasted while others will have to be roasted dark to develop the aroma. Therefore, appearance alone is not a proper test. Aroma-saving devices have had their day. Coffee is of no use unless the aroma is fully developed,

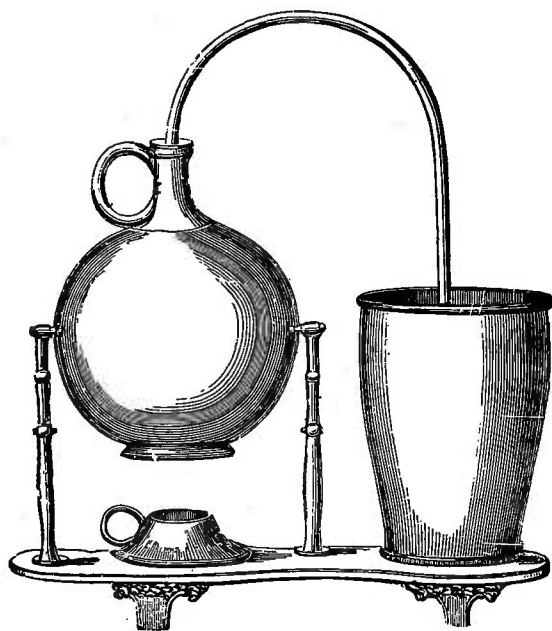
and the more it is developed by roasting the better it is. What passes off in the roasting process can not be saved and is so small that if all of it in the country could be collected and freed of all foreign matter, it would not weigh an ounce.

Roast coffee over a slow fire so that it will be an hour before it has the color of roasted coffee, and, in contrast, produce in another batch of like quantity the same color in thirty minutes, and it will be found for all intended purposes, either to grind, sell or drink, that the latter will be, beyond all comparison, the best. Coffee should be roasted uniform and as quickly as possible, only it must not be scorched or spotted, otherwise it will have a bitter burned taste. If roasted properly it will very considerably increase its bulk and will be plump, swelled out and crisp; easily crushed in the hand or between the fingers.

In his *Spice Mill Companion*, published in 1879, Jabez Burns said further in regard to roasting:

All coffees do not roast alike; some will be a bright light color when done, and others will be dark before done. There are two infallible rules, which if properly appreciated and tried will prove to be practically useful. One is, when the aroma is sufficiently developed to produce a sharp, cutting, but aromatic sensation in the nose. Those who practice that way do not need to see the roast. The other rule is that when a berry is broken it is crisp and uniform in color inside and out. Those who are accustomed to this method may be good coffee roasters, albeit they may not have any nose at all. But we must state in this connection, that a man who has no smell and is color blind is not a fit candidate for the coffee roasting profession; and, moreover, we affirm that any person who can not roast coffee, so far as judgment is concerned, after a few trials, will never make a good operator.

In 1867, Jabez Burns was granted a United States patent on an improved coffee cooler, mixer, and grinding mill, or granulator. Another granulator patent was issued to him in 1872. Mr. Burns had also given the subject of cooling coffees considerable study, and his cooler was the result. He argued that it was necessary to cool quickly. Before his day, various methods had been employed, such as placing the coffee in revolving drums covered with wire cloth. Sometimes a draft of cold air was applied to the cooling drums, and the dirt and chaff blown through the wire cloth. It was also customary in wholesale establishments to blow cold air up through a perforated bottom, and this had been found effective when properly applied. The Burns idea was to cool by means of suction, causing a downward draft through the coffee and wire-cloth bottomed box, which was found to be more uniform and efficient for cooling purposes, as well as in controlling



NAPIER'S VACUUM MACHINE, 1840

smoke, heat, and dust, which by this means could be blown out of the roasting room by any convenient outlet.

On the subject of grinding, likewise, Mr. Burns had reached some definite conclusions. The French and English lap and wall mills, the English steel mills, and the Swift mills were all used in the United States. Troemner's, the Enterprise, and others—to be mentioned later in chronological order—were extending their use in a retail way; but Jabez Burns confined his attention to a practicable mill for wholesale grinding establishments.

For manufacturing purposes, burstone mills were for many years exclusively employed, especially one first known as the Prentiss & Page, and later as the Page mill. There was a time when all the coffee establishments in New York sent their coffee to Prentiss & Page to be ground. Some of the places roasted by hand, others by horse power; and if by steam, it was limited, and they did not have enough to spare for grinding.

With the march of improvement, burstone mills went into the discard. The difficulty lay in finding men experienced in stone dressing to run them; and the demand grew for a better style of grinding than could be done in a mill out of face and balance. This demand was met in an altogether different style of machine, which for twenty-five years was well known as

the Barbor mill. It was for improvements on this mill that Jabez Burns in 1867, 1872, and 1874 obtained his granulator patents.

The mill comprised cutters in the form of an iron roller running in near contact with a concave, also of iron, and a revolving cylinder provided with sieves, or screens, that received the ground material, rolled it over the wire surface, sifting out the fine and discharging the coarse automatically into the cutter, to be again manipulated until it was fine enough to pass through the meshes of the screen.

Jabez Burns patented an improved form of his roaster in 1881, and a sample-coffee roaster in 1883, before he died in 1888; and since that time his sons, who continued the business, perfected a number of improvements and brought out new machines which will be referred to in chronological order.

#### *Other Patents Since 1864*

In 1864, James Henry Thompson, of Hoboken, and John Lidgerwood were granted an English patent on a coffee-hulling machine.

James H. Nason, of Franklin, Mass., was granted a United States patent in 1865 on a percolator with fluid joints.

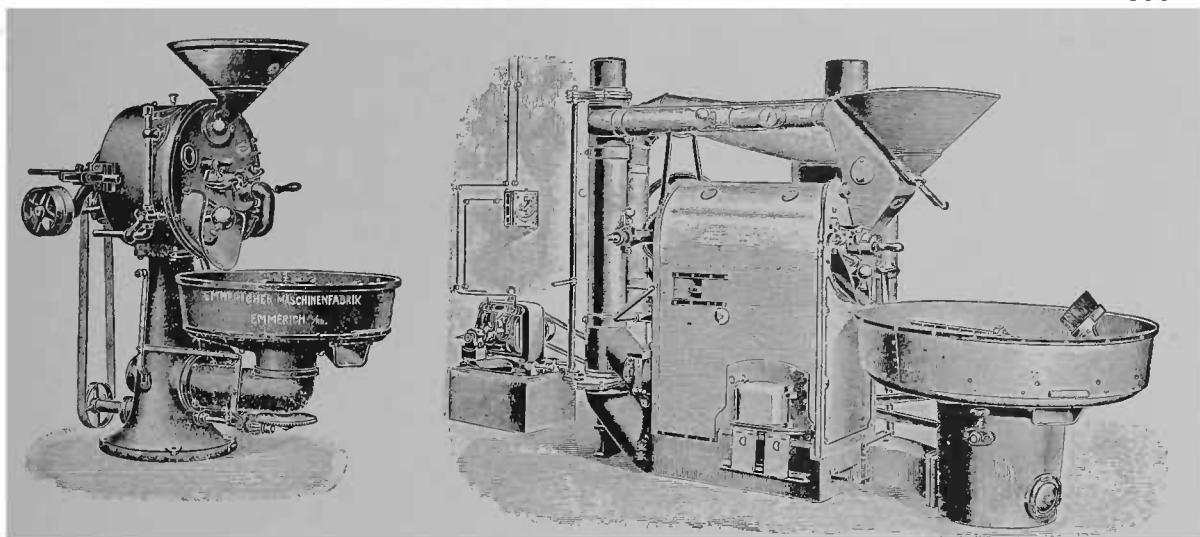
P. H. Vanderweyde, of Philadelphia, was granted United States patents in 1866 on a percolator and a continuous coffee-filtering machine.

William van Vleek Lidgerwood, American chargé d'affaires at Rio de Janeiro, was granted an English patent on a coffee hulling and cleaning machine in 1866.

Raparlier was granted a French patent on a pocket coffee-making device in 1867. In later years, his invention became very popular among French coffee drinkers. It was one of the early practicable forms of double-glass-globe filtration devices.

E. B. Manning of Middletown, Conn., was granted his first patent on a tea and coffee pot in 1868. Others followed in 1870 and 1876. In the latter year, John Bowman brought out the valve-type percolator which subsequently attained great favor in American households.

Thomas Page, a New York millwright, began the manufacture of a pull-out coffee roaster similar to the old Carter machine, in 1868. Later, Chris Abele, who was fore-



GERMAN GAS AND COAL ROASTING MACHINES

Left, "Perfekt" gas roaster—Right, "Probat" coal roaster.

man in the Page shop, succeeded to the business; and in 1882, he was granted a United States patent on an improvement on a coffee roaster similar to the original Burns machine (the patent had then expired), which he marketed under the name of Knickerbocker.

#### *German Coffee Machinery*

The Germans first began to show an active interest in coffee machinery in 1860. In that year, Alexius van Gulpen, of Emmerich, produced a green-coffee grader; and later (1868), in partnership with J. H. Lensing and Theodore von Gimborn, began the manufacture of coffee-roasting machines. From this start there developed in Emmerich quite an industry in coffee-machinery building. In 1870, Alexius van Gulpen introduced to the German trade a globular coffee roaster employing wood and coke as fuel and having perforations and an exhauster. Van Gulpen and von Gimborn are the two names most often met with in the development of German coffee-roasting machinery.

The first recorded German patent on a coffee roaster was issued to G. Tubermann's Son in 1877, for "a coffee burner with vertically adjusted stirring works." German patents were issued in 1878 to R. Muhlberg, of Taucha, for coffee roasters with movable partitions and "screw-shaped declining walls." Six roaster patents were issued to other inventors in 1878-79.

Peter Pearson, of Manchester, took out a German patent on a coffee-roasting appa-

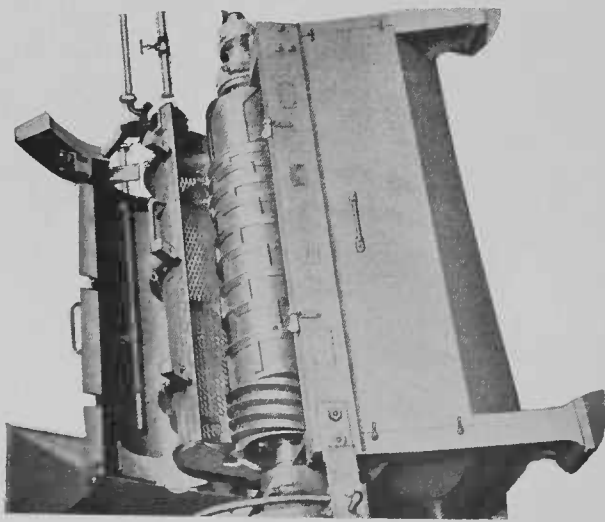
ratus in 1880. Fleury & Barker, of London, were granted a coffee-roaster patent in Germany in 1881.

After 1870, Van Gulpen devoted himself to the cylinder type of roaster, on which he obtained several patents. The partnership between Messrs. van Gulpen, Lensing and von Gimborn was dissolved in 1906. They were succeeded by the Emmericher Maschinenfabrik und Eissengiesserei, and Van Gulpen & Co. Van Gulpen died in 1920. Among his inventions were a circular air fan to supply fresh air to the beans while roasting; a fire-dampening device; roasting and cooling exhausters; and a "withdrawable" mixer remaining inside the cylinder during the roasting process, but designed to be withdrawn at the end, discharging the contents with a jerk into a circular cooler. These improvements are featured in Van Gulpen & Co.'s latest Meteor machine. They make also the Typhoon and Comet machines, and a line of globular roasters.

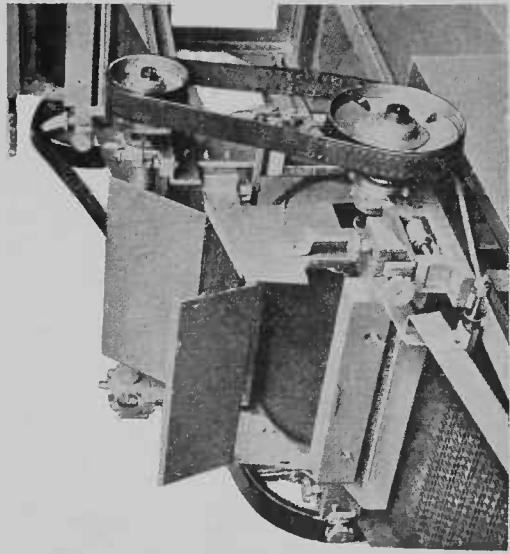
A dozen coffee-roaster patents were issued in Germany in 1880-82. Among them was one to the Emmerich Machine Factory and Iron Foundry, van Gulpen, Lensing & von Gimborn, Emmerich, in 1882.

Numerous coffee-cooling, coffee-grinding, and coffee-making devices were patented in Germany from 1877 to 1885; among them Newstadt's coffee-extract machine in 1882, safety attachments, rapid filters, Vienna coffee makers, etc. The first Vienna coffee maker seems to have been patented in Germany in 1879.

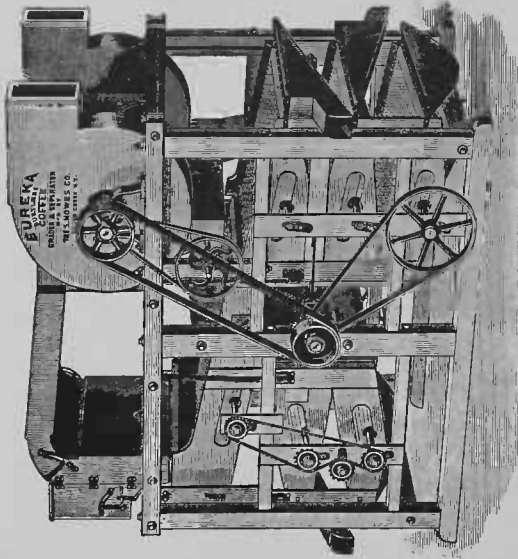
The Emmerich Machine Factory and Iron



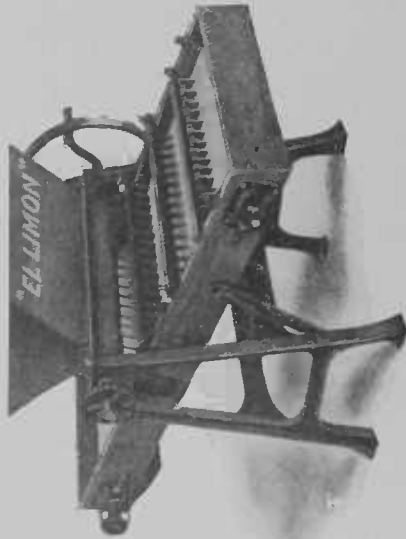
KRUPP'S "RAOBENG" PULPER (German)



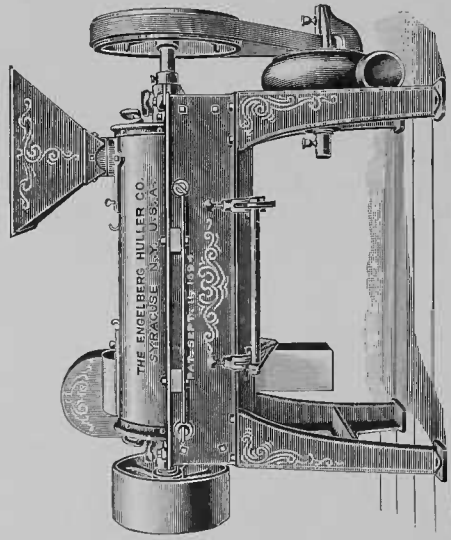
KRUPP'S "VOGETS" DOUBLE PULPER (German)



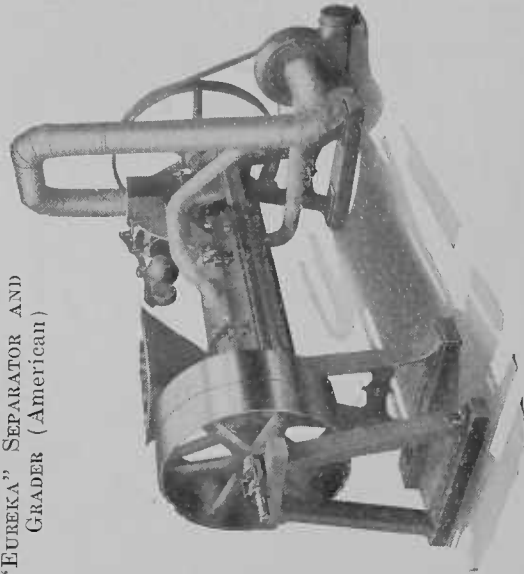
"EUREKA" SEPARATOR AND GRADER (American)



"CARACOLILLO" (PEABERRY) SEPARATOR (American)



ENGELBERG HULLER AND SEPARATOR (American)



THE "AMERICAN" COFFEE HULLER AND POLISHER

WELL KNOWN AMERICAN AND GERMAN HULLING AND SEPARATING MACHINES



Foundry acquired certain Danish and Austrian coffee-roaster patents in 1881, and in 1892 it was granted a German patent on a ball roaster. In the eighties this concern began the manufacture of a closed ball, or globular, roaster with gas-heater attachment. It acquired, in 1889, the rights for Germany to manufacture gas roasters under the Dutch Henneman patents of 1888. In 1892, Theodore von Gimborn was granted French and English patents on a coffee roaster employing a naked gas flame in a rotary cylinder. In 1897, the Emmericher concern was granted a German patent on an automatic circular tipping cooler with power drive. Today, this factory features the Probat and Perfekt roasters, but manufactures a general line of cylinder and ball machines for coal, coke, and gas.

Among others engaged in the manufacture of coffee machines in Germany are G. W. Barth, Ludwigsburg, and Ferd. Gothot, Mulheim on Ruhr. The latter manufactures a coke- or gas-heated quick roaster known as the "Ideal-Rapid," and a smaller hand-power machine, of the same type, called "Favour."

#### *American, French, and British Machines*

In 1869, Élie Moneuse and L. Duparquet, of New York, were granted three United States patents on a coffee pot or urn made of sheet copper and lined with pure sheet block tin. These patents were the founda-

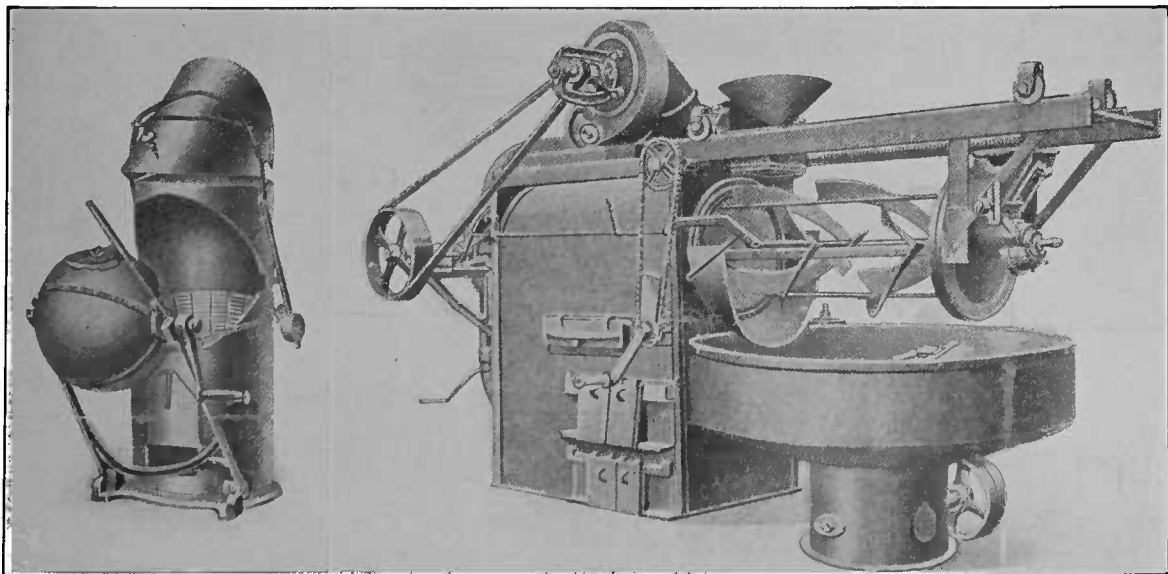
tion of the successful coffee-urn business afterward built upon under the name of the Duparquet, Huot & Moneuse Co.

Thomas Smith & Son (Elkington & Co., Ltd., successors) began, in 1870, the manufacture of the Napierian coffee-making machine at Glasgow, Scotland. This was a device for making coffee by distillation, employing a metal globe syphon and brewer with filter cloth. The principle was subsequently used in the Napier-List steam coffee machine for ships and institutions patented in England in 1891.

John Gulick Baker, of Philadelphia, one of the founders of the Enterprise Manufacturing Co. of Pennsylvania, was granted a United States patent in 1870, on a coffee grinder introduced to the trade as the Enterprise Champion No. 1 store mill. Another Baker patent was granted in 1873, and this became known as the Enterprise Champion Globe No. 0. These mills were the pioneer machines for store use.

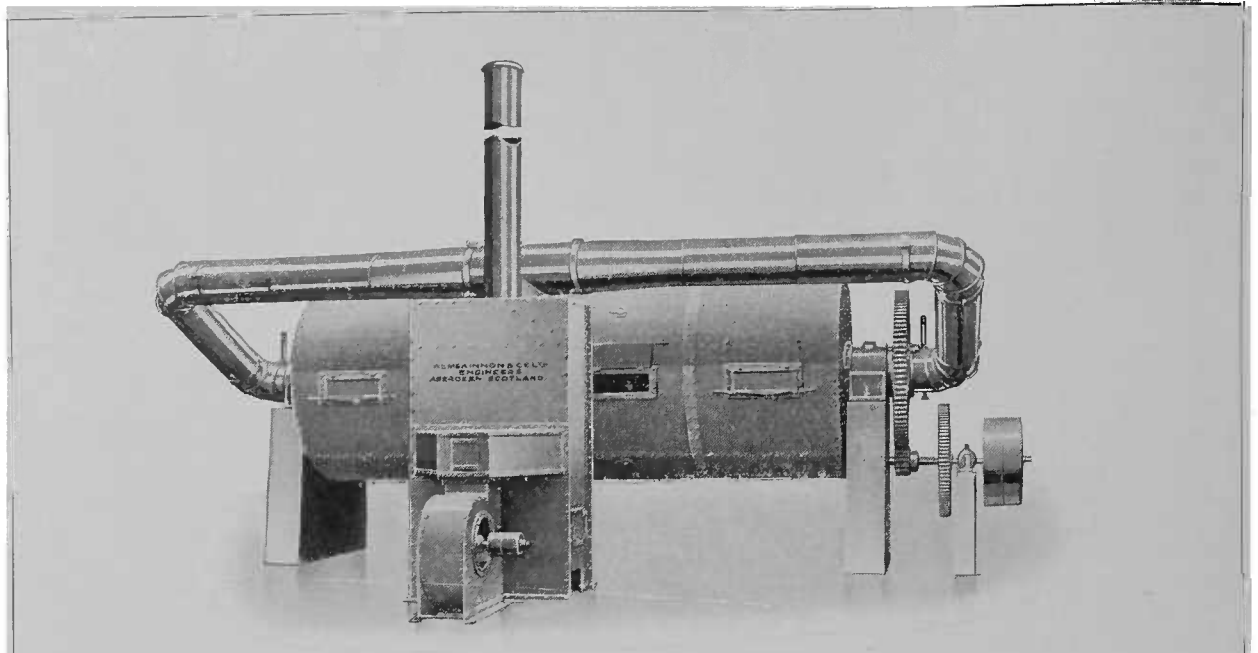
In 1870, Delphine, Sr., of Marourme, France, was granted a French patent on a tubular coffee roaster which turned over a flame.

In the 'sixties and 'seventies, French inventors became quite active on coffee-roaster improvements. Many patents were granted, and quite a few were for practical small-capacity machines that have survived, and are in use today in France and on the continent. Some supplied inspiration for inventors in neighboring countries. Among

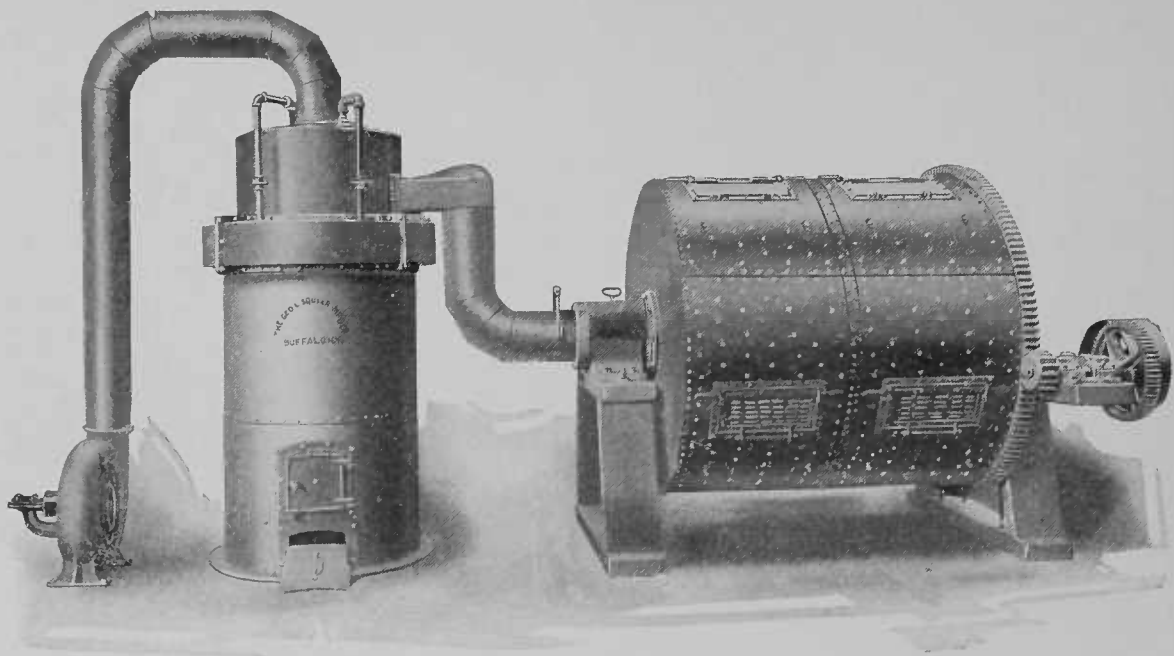


OTHER GERMAN COFFEE ROASTERS

*Left, globular machine—Right, "Meteor" quick-roasting outfit*



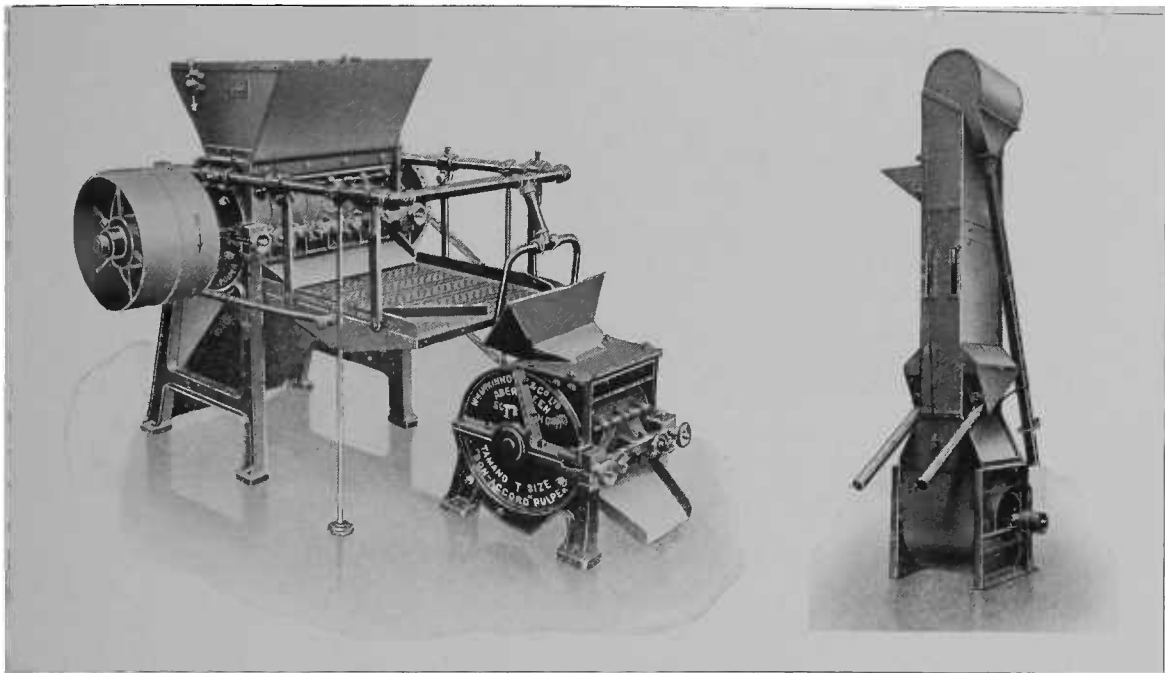
MCKINNON'S "GUARDIOLA" COFFEE DRIER WITH "MILLETHERM" HEATER AND FAN



THE "SQUIER-GUARDIOLA" COFFEE DRIER, WITH DIRECT-FIRE HEATER

### BRITISH AND AMERICAN COFFEE DRIERS—GUARDIOLA SYSTEM

There are numerous makes of coffee driers based upon the original invention of José Guardiola of Chocoma, Guatemala. In the two illustrated above both direct-fire heat and steam heat may be utilized.



TANDEM COFFEE PULPER AND PNEUMATIC SEPARATOR OF BRITISH MAKE

The pulper (*left*) is a combination of a "Bon Accord-Valencia" pulper and a "Bon Accord" repassing machine. The "Catador" separator (*right*) is a pneumatic and gravity machine for removing extraneous matter from coffee.

the more notable names, mention should be made of Martin, of St. Quentin, who produced a sheet-iron cylinder roaster with "interior gatherer" in 1860; Marchand, of Paris, "fan roaster with movable fire box," 1866 and 1869; Lauzaune, Paris, "rocking system of roasting coffee in a round stove," 1873; Ittel's glass sphere, Lyons, 1874; and Marchand and Hignette, Paris, 1877, a ball coffee roaster.

Probably the name most familiar to coffee men in connection with plantation methods is Guardiola. It first appears in the chronological record in 1872, when J. Guardiola, of Chocoma, Guatemala, was granted several United States patents on machines for pulping and drying coffee. Since then, "Guardiola" has come to mean a definite type of rotary drying machine that—after the original patent expired—was manufactured by practically all the leading makers of plantation machinery. Various improvements have been embodied in the Guardiola system, and today the makers of coffee-manufacturing equipment claim to have produced driers of this type which definitely obviate the possibility of over- or under-drying coffee. José Guardiola obtained additional United States patents on coffee hullers in 1886.

William Van Vleek Lidgerwood, Morristown, N. J., was granted an English patent on an improved coffee pulper in 1875.

Several important cleaning and grading machinery patents were granted by the United States (1876-1878) to Henry B. Stevens, who assigned them to the Geo. L. Squier Manufacturing Co., Buffalo, N. Y. One of them was on a separator, in which the coffee beans were discharged from the hopper in a thin stream upon an endless carrier, or apron, arranged at such an inclination that the round beans would roll by force of gravity down the apron, while the flat beans would be carried to the top.

C. F. Hargreaves, of Rio de Janeiro, was granted an English patent on machinery for hulling, polishing, and separating coffee, in 1879.

The first German patent on a coffee drying apparatus was granted to Henry Scolfield, of Guatemala, in 1880.

In 1885, Evaristo Conrado Engelberg of Piracicaba, São Paulo, Brazil, invented an improved coffee huller which, three years later, was patented in the United States. The Engelberg Huller Co. of Syracuse, N. Y., was organized the same year (1888) to make and to sell Engelberg machines.

Walker Sons & Co., Ltd., began, in 1886,



"BRITANNIA" COFFEE GRADER OR CLASSIFIER

experimenting in Ceylon with a Liberian disk pulper that was not fully perfected until twelve years later.

Another name, that has since become almost as well known as Guardiola, appears in the record in 1891. It is that of O'Krassa. In that year R. F. E. O'Krassa of Antigua, Guatemala, was granted an English patent on a coffee pulper. Additional patents on washing, hulling, drying, and separating machines were issued to Mr. O'Krassa in England and in the United States in 1900, 1908, 1911, 1912, and 1913.

The Fried. Krupp A. G. Grusonwerk, Magdeburg-Buckau, Germany, began the manufacture of coffee plantation machines about 1892. Among others it builds single and double coffee pulping machines of the "Raoeng" and "Vogts" types, shown in the illustration on page 600.

Additional United States patents were granted in 1895 to Marcus Mason, assignor to Marcus Mason & Co., New York, on machines for pulping and polishing coffee. Douglas Gordon assigned patents on a coffee pulper and a coffee drier to Marcus Mason & Co. in 1904-05.

The names of Jules Smout, a Swiss, and Don Roberto O'Krassa, of Guatemala, are well known to coffee planters the world over because of their combined peeling and polishing machines.

The Huntley Manufacturing Co., Brocton, N. Y., began in 1896 the manufac-

ture of the Monitor line of coffee-grading-and-cleaning machines. In 1929, the company was granted a U. S. patent on an improved three-roll coffee grinder, and in 1932, on an improved grinder.

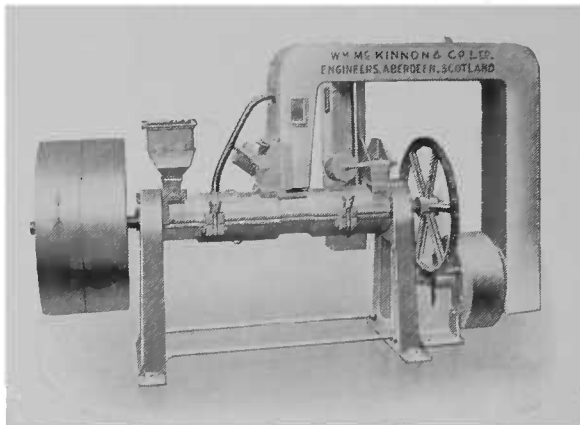
According to the patent records, Roure, of Marseilles, appears to have produced the original gas coffee roaster in 1877. The evolution of the gas roasting-machine was as follows:

#### *Evolution of the Gas Roaster*

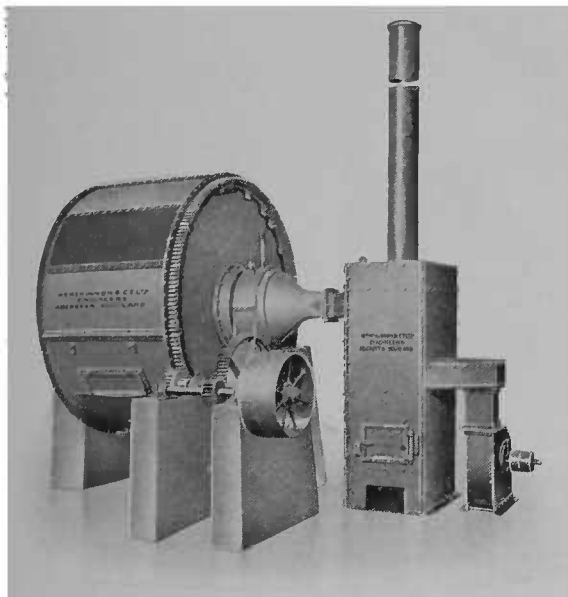
In 1879, H. Faulder, of Stockport, England, obtained an English patent on an external air-blast burner applied to a cylinder gas machine, which is still being manufactured by the Whitmee Engineering Co., Ltd., of London. Fleury and Barker, of London, followed with another English gas machine in 1880, the heat being supplied from gas jets over the roasting cylinder. In 1881, Peter Pearson, of Manchester, produced a gas roaster which consisted of a wire-gauze cylinder revolving under a metal plate heated by gas.

Beeston Tupholme, of London, was granted an English patent in 1887, on a direct-flame gas roaster which he assigned to Joseph Baker & Sons.

Karel F. Henneman, the Hague, Netherlands, took out his first patent on the Henneman direct-flame gas roaster in Spain in 1888; and the following year, he obtained patents in Belgium, France, and



AN "O'KRASSA" TYPE PEELER AND POLISHER



MCKINNON'S "O'KRASSA" TYPE DRIER COMBINED WITH "MILLETHERM" HEATER AND FAN

England. His United States patents were granted in 1893-95.

Postulart secured a patent in France for a gas coffee roaster in 1888.

The Germans also began, in the 'eighties, to take the quick gas coffee roaster seriously. In 1889, Carl Alexander Otto, of Dresden, secured a German patent on a spiral tubular machine to roast coffee in three and a half minutes. It was first manufactured and sold by Max Thurmer, of Dresden, in 1891-93 (see page 608).

The subject of quick roasting has greatly agitated German and French coffee men. Otto found that coffee roasted in small quantities (say fifty grams) on a sample-roaster produced a finer flavor and aroma than that roasted in the big machines. He set out to produce a machine that would roast continuous small quantities in the shortest time. He built the first commercial machine under his patent in 1893. It was shown at the International Food Exhibition in Dresden in 1894. The latest type manufactured by Max Thurmer, Dresden, in which firm Otto is a partner, has a spiral five meters long and an hourly production of about 450 pounds. The Thurmer machine, as it is called, has been sold to the trade since 1914.

Quick roasting is gone in for quite extensively in Germany, even in the big trade-roasting plants, where machines to roast in ten to seventeen minutes are common. Natural, slow cooling is most necessary with

quick roasting, according to Thurmer. On the other hand, A. Mottant, of Paris, who also manufactures a line of quick gas-roasting machines, called "Magic," argues that quick cooling is essential after quick roasting. Three of the Mottant machines are illustrated on pages 606 and 607.

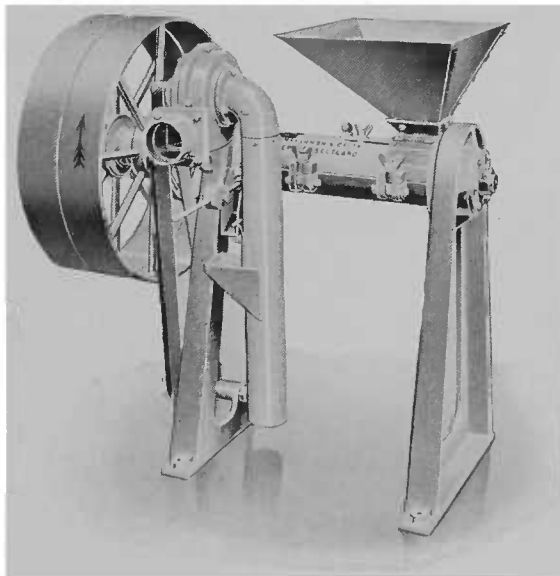
Other quick-roasting machines of German make are the "Combinator," "Tornado," and "Rekord."

In a lecture before the Society of Medical Officers of Health, London, October 24, 1912, William Lawton demonstrated to the satisfaction of his audience that coffee could be roasted in 3 minutes, using a perforated gas-roaster of his own invention.<sup>4</sup>

The first direct-flame gas coffee roaster in America was installed in the plant of the Potter-Parlin Co., New York, by F. T. Holmes, in 1893. This was Tupholme's machine, patented in England in 1887, and in the United States in 1896-97. The Potter-Parlin Co. subsequently placed the Tupholme machines throughout the United States on a daily rental basis, limiting its leases to one firm in a city, having obtained the exclusive American rights from the Waygood, Tupholme Co., now the Whitme Engineering Co., Ltd.

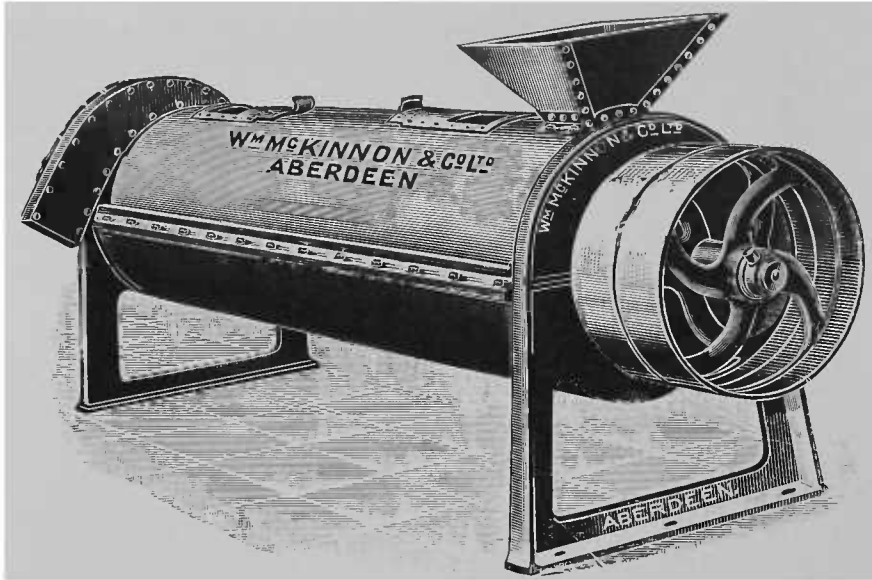
The Henneman direct-flame gas roaster was introduced to the United States trade in 1905, by C. A. Cross & Co., wholesale grocers, of Fitchburg, Mass. It was marketed here seven years, but was never a great success.

<sup>4</sup> *Tea and Coffee Trade Jour.*, 1912 (vol. xxiii: no. 6: p. 592).



THE "SMOUT" PEELER AND POLISHER



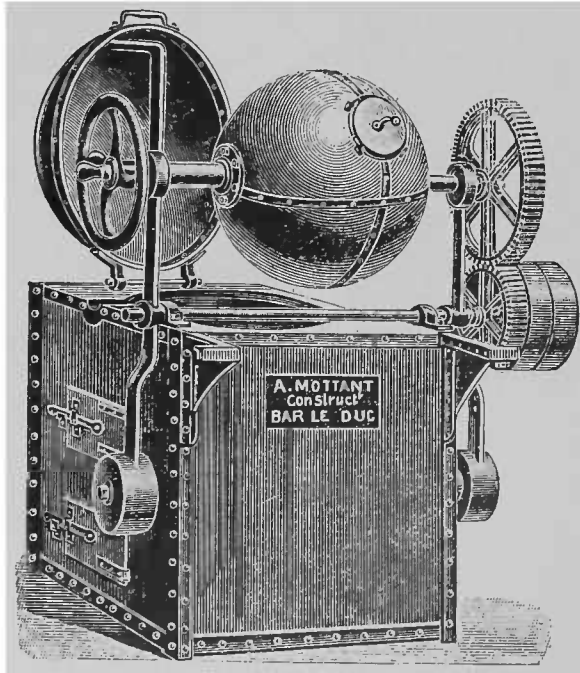


CONTINUOUS WORKING HORIZONTAL COFFEE WASHER

Natural gas was first used in the United States as fuel for roasting coffee in 1896, when it was introduced under coal roasting cylinders in Pennsylvania and Indiana by the use of improvised gas burners.

Edwin Crawley and W. T. Johnston, Newport, Ky., assignors to the Potter-Parlin Co., New York, were granted four United States patents on gas coffee-roasting machines, about this time.

In 1897, a special gas burner, not to be confused with the direct-flame machine,



FRENCH GLOBULAR ROASTER

was first attached to a regular Burns roaster in the United States, and was made the basis of application for a patent.

In 1897-99, David Fraser, of New York, began to market in the United States a central-heated gas-fuel machine with an inner wire-cloth cylinder to keep the coffee from dropping into the flame, developed under United States patents granted to Carl H. Duehring, of Hoboken, in 1897, and to D. B. Fraser in 1899.

M. F. Hamsley, of Brooklyn, was granted a United States patent on an improved direct-flame gas roaster in 1898.

Ellis M. Potter, New York, was granted in 1899, a United States patent on an improved direct-flame gas roaster in which the flame was spread over a large area to avoid scorching and to insure a more thorough and uniform roast. In the Tupholme machine, the gas flame entered at one end, and the smoke and flame went out through a stack on top. In the Potter machine, the stack was put on the end opposite the gas intake, with a fan to pull the flame all the way through.

The Burns direct-flame gas roaster, with patented swing-gate head for feeding and discharging, was introduced to the trade in 1900. The Burns gas sample-roaster followed.

In 1901, Joseph Lambert, of Marshall, Mich., introduced to the trade one of the earliest indirect gas roasting machines.

In 1901, also, T. C. Morewood, of Brentford, England, was granted an English patent on a gas roaster fitted with a sliding burner and a removable sampling tube. This machine is now being made by the Whitmee Engineering Co., Ltd.

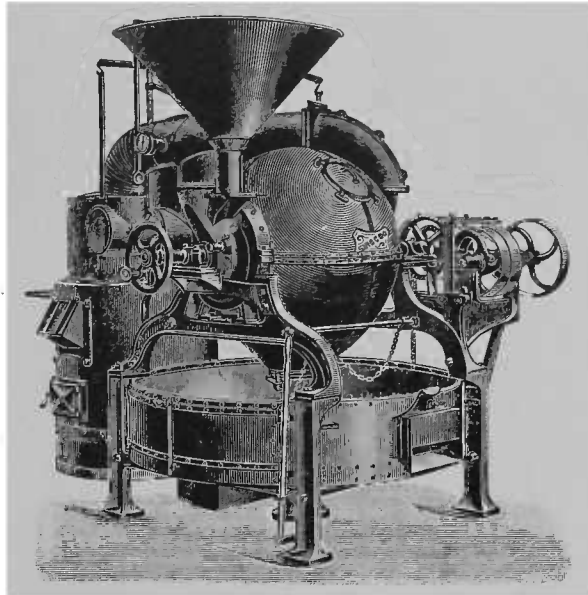
In the same year, 1901, F. T. Holmes, formerly with the Potter-Parlin Co., joined the Huntley Manufacturing Co., Silver Creek, N. Y., which then began to build the Monitor direct-flame gas coffee roaster. Mr.

Holmes still further improved the Tupholme idea by putting gas burners in both ends of the roasting cylinder, with the pipes bent down so as to cause the gas flame to go first to the bottom and then up to the stack on top.

In 1906, F. T. Holmes was granted a United States patent on a coffee roaster which he assigned to the Huntley Manufacturing Co.

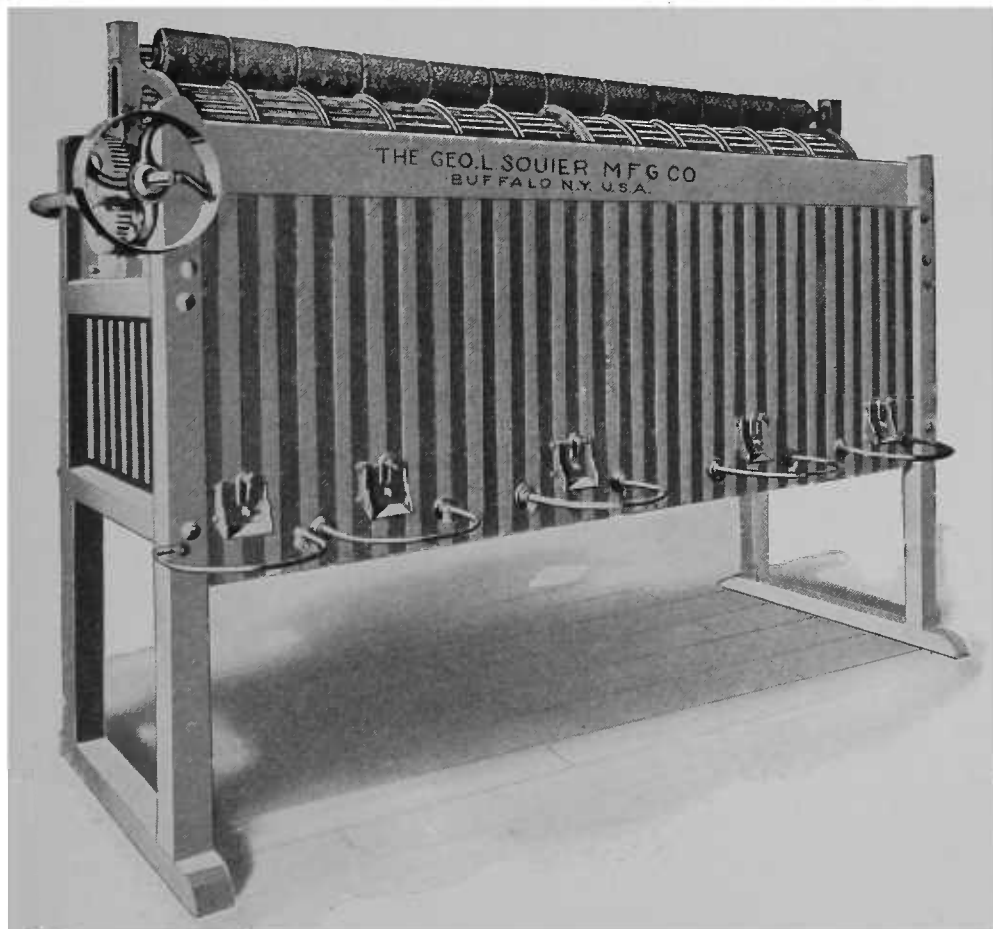
J. C. Prims, of Battle Creek, Mich., was granted a United States patent in 1908, on a corrugated cylinder improvement for a gas and coal roaster designed for retail stores. The A. J. Deer Co., Hornell, N. Y., acquired this machine in 1909, and began to market it as the Royal coffee roaster. An improvement patented in 1915 by J. C. Prims was assigned to the A. J. Deer Co.

In 1915, and again in 1919, Jabez Burns & Sons, New York, patented their Jubilee roaster, an inner-heated machine in which the gas is burned inside a revolving cylinder in a combustion chamber pro-

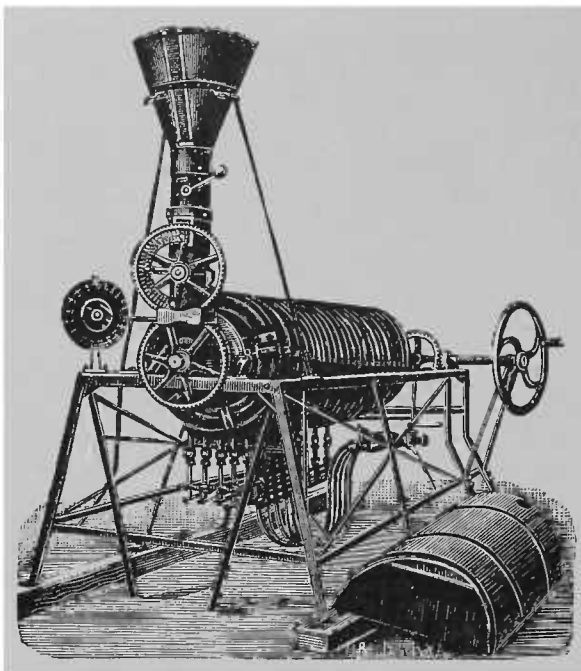


"SIROCCO" ROASTER MACHINE (FRENCH)

tected from direct coffee contact. The heat is deflected downward and then passes upward through the coffee.



"EL MONARCHA" COFFEE CLASSIFIER



MAX THURMER'S QUICK GAS ROASTER, 1891-93

In 1919, William Fullard (*d.* 1921), of Philadelphia, was granted a United States patent on a "heated fresh air system" roaster, in which the fresh air is forced by an electric fan through a pipe to a set of coils over gas, coal, or oil flame. At the top of the coils is a manifold, the hot air being forced through small holes to circulate in and around a regulation perforated roasting cylinder; the vapors and spent air are then drawn into an overhead exhaust pipe that connects with a pipe provided with a fresh-air intake, the idea being to return them to the roasting cylinder after being mixed with fresh air and heated in the coils as before. This patent has not been successfully marketed at the time of writing. The purpose is to roast by heated air not mixed with any furnace gases. Whether this can be done with sufficient fuel economy, and whether coffee thus roasted would have any greater value, are questions that are raised by the coffee experts.

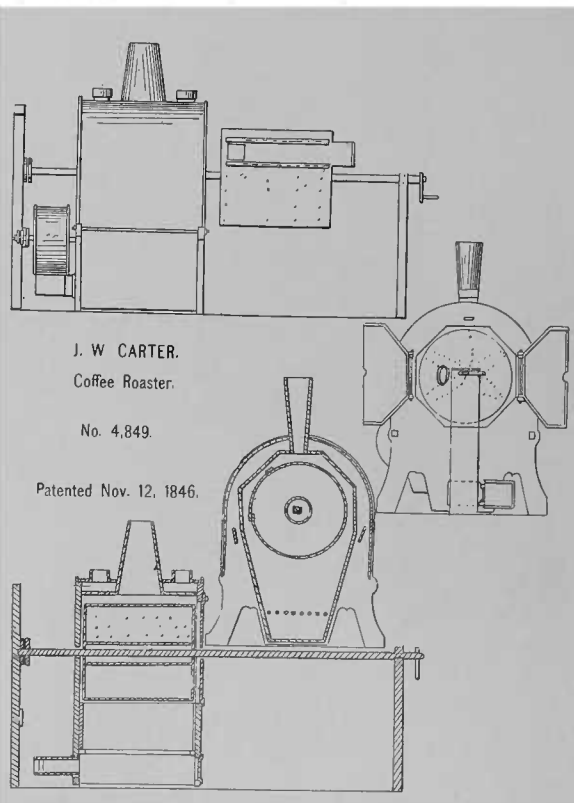
In 1925, Wm. G. Burns of New York, and Harry Russell Maxon, Muncie, Ind., assignors to Jabez Burns & Sons, Inc., New York, were granted a United States patent for a coffee roaster with a homogeneous, elongated flame and means for discharging the roast. Also in the same year, Richard A. Greene, of New York, assignor to Jabez Burns & Sons, Inc., was

granted a United States patent covering a plurality of roasting cylinders which could be operated and discharged independently and without interfering with each other.

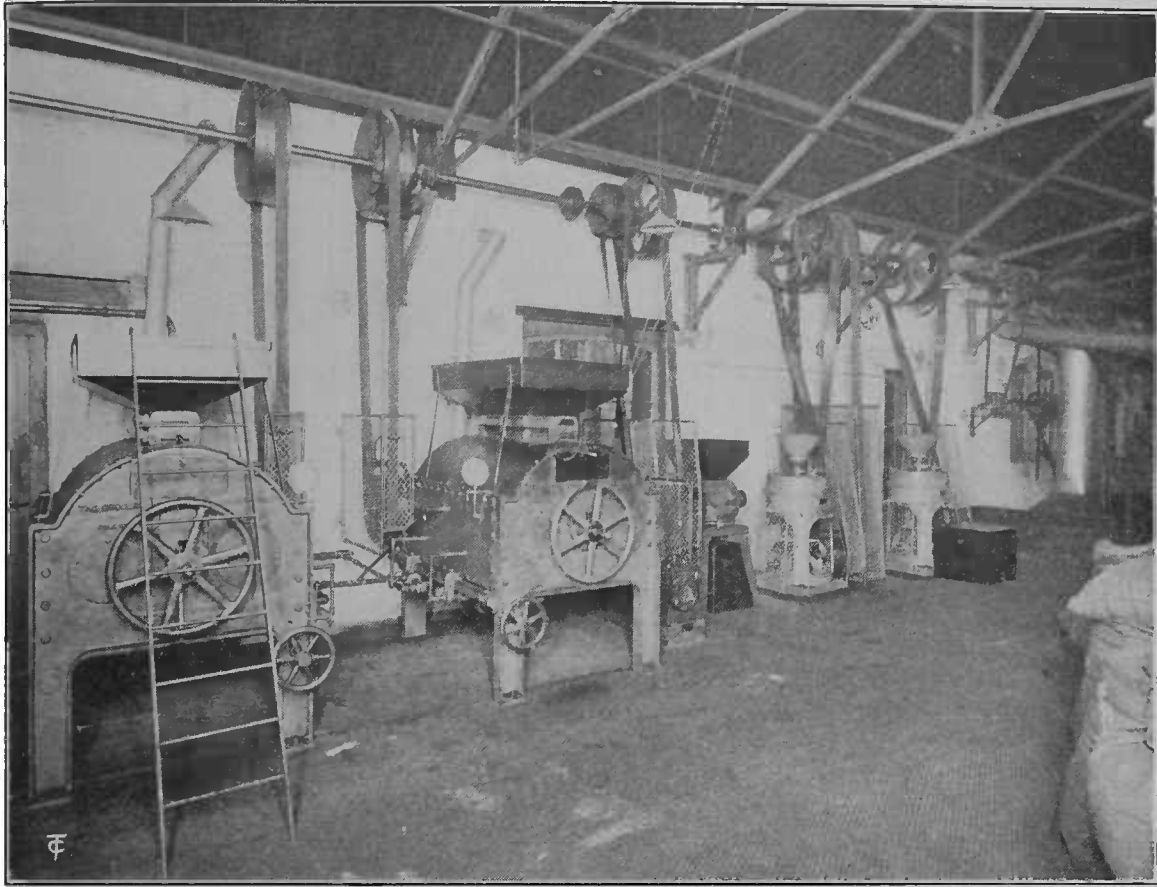
In 1927, J. L. Kopf, of East Orange, N. J., assignor to Jabez Burns & Sons, Inc., was granted a United States patent for a coffee product—and method and apparatus for making it—consisting of granulated coffee from which chaff is removed, separately ground to a fine powder and remixed with the coffee in the normal proportions found in nature. Canadian patents for the same inventions were granted in 1928.

In 1932, Wm. G. Burns and R. A. Greene, both of New York, assignors to Jabez Burns & Sons, Inc., were granted a United States patent on a stirring cooler for coffee by which uniform currents of cool air are brought simultaneously to every part of the mass of coffee.

In 1932, George C. Herz, assignor to Jabez Burns & Sons, Inc., was granted a United States patent on an improved pneumatic separator, for removing stones, etc., from coffee and similar products, which provides automatic regulation of air

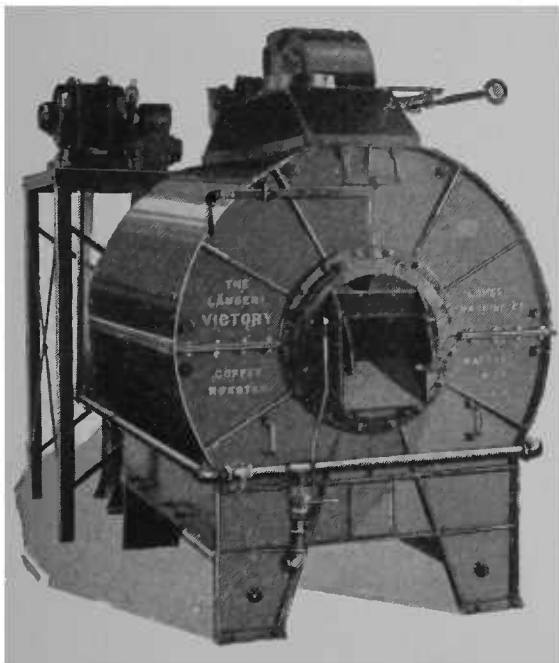


CARTER'S PULL-OUT ROASTER PATENT



BRITISH GAS COFFEE-ROASTING PLANT

The machines are the Morewood (improved Faulder) sliding-burner indirect type.



LAMBERT'S "VICTORY" GAS MACHINE, AS MANUFACTURED IN 1922

flow for accurate separation and subsequent rapid lifting of the cleaned product.

In 1935, J. L. Kopf, East Orange; Leslie Backer, Summit; and Joseph H. Keenan, Hoboken, N. J., assignors to Jabez Burns & Sons, Inc., were granted a United States patent covering a method of roasting coffee and like materials by recirculation of a gaseous heating medium through a source of heat, thence to the product and back to the heat source.

#### *Coffee-Grinding and Coffee-Making Chronology*

To return to our coffee-grinding and coffee-making chronology, it is to be noted that in 1875-76-78, Turner Strowbridge, of New Brighton, Pa., was granted three United States patents on a box coffee mill, first made by Logan & Strowbridge, later the Logan & Strowbridge Iron Company, the latter being succeeded by the Wrightsville Hardware Co. in 1906.

In 1878, a United States patent was is-

sued to Rudolphus L. Webb, assignor to Landers, Frary & Clark, New Britain, Conn., on an improved box coffee grinder for home use.

In 1878, and in 1880, United States patents were issued to John C. Dell of Philadelphia on a store coffee mill.

In 1879, and in 1880, United States patents were issued to Orson W. Stowe, of the Peck, Stowe & Wilcox Co., Southington, Conn., on a household coffee mill.

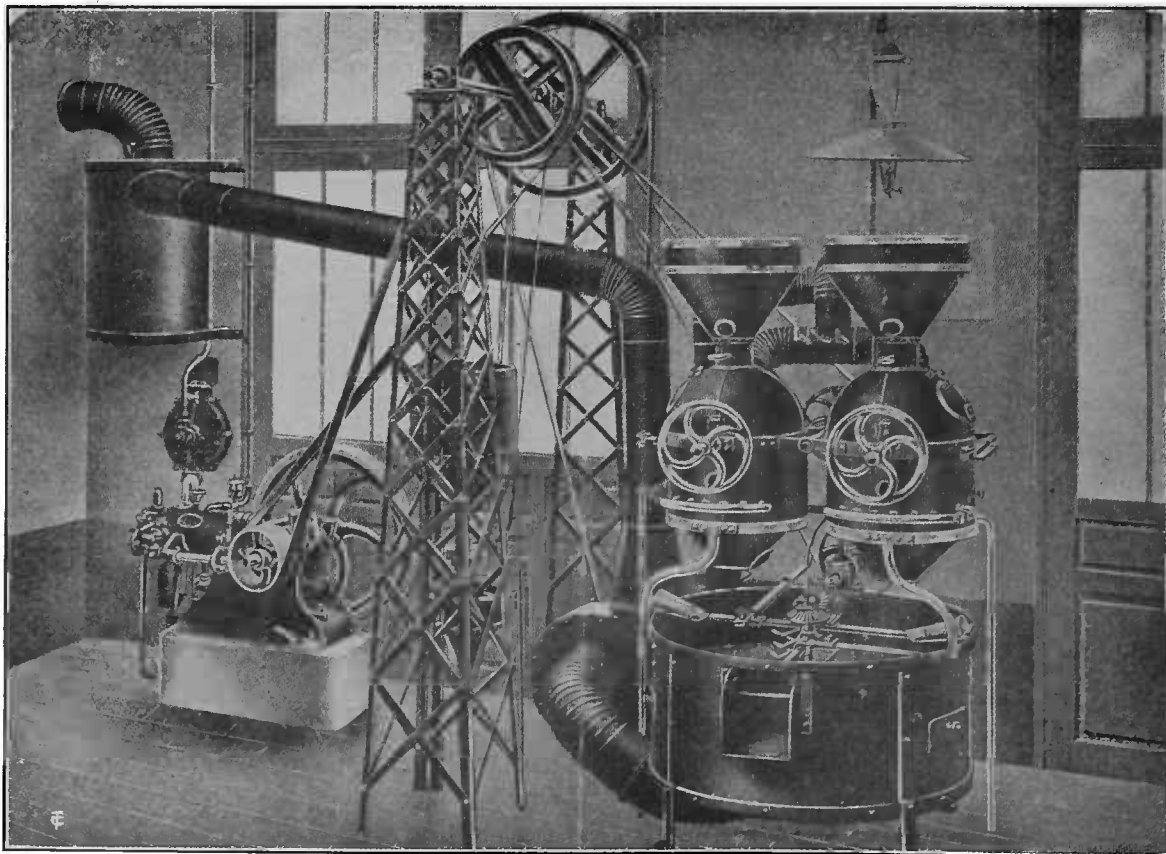
In 1879, Charles Halstead, of New York, was granted the first United States patent on a metal coffee pot having a china interior. It was an infuser for home use.

In 1880, coffee pots, with tops having muslin bottoms for clarifying and straining, were first made in the United States by the Duparquet, Huot & Moneuse Co., of New York.

The name Hungerford first appears in the United States patent records in 1880-81, in connection with patents granted to G. W. and G. S. Hungerford on machines for cleaning, scouring, and polishing coffee. In 1882, the Hungerfords, father and son, brought out a roaster. This machine and

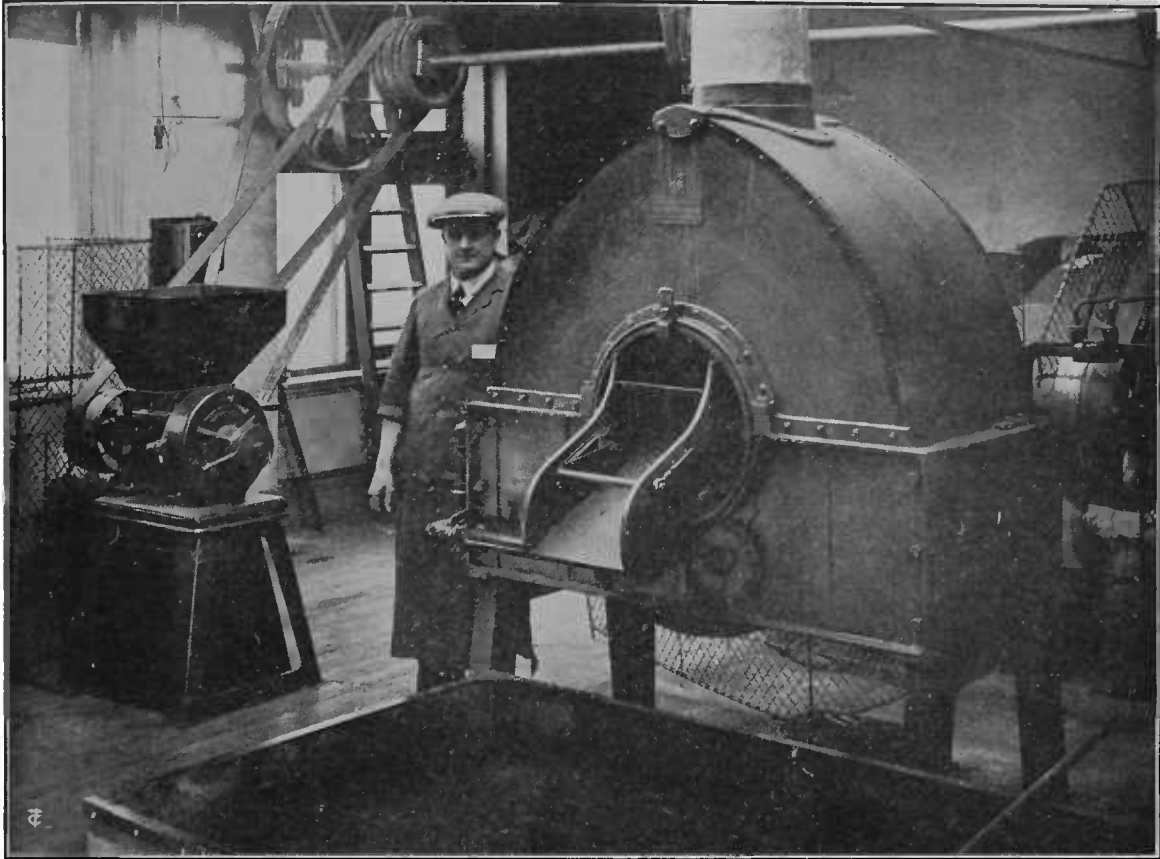


THE BURNS "JUBILEE" GAS MACHINE, AS MANUFACTURED IN 1922



DOUBLE "AROMATIC" GAS ROASTING OUTFIT (FRENCH)

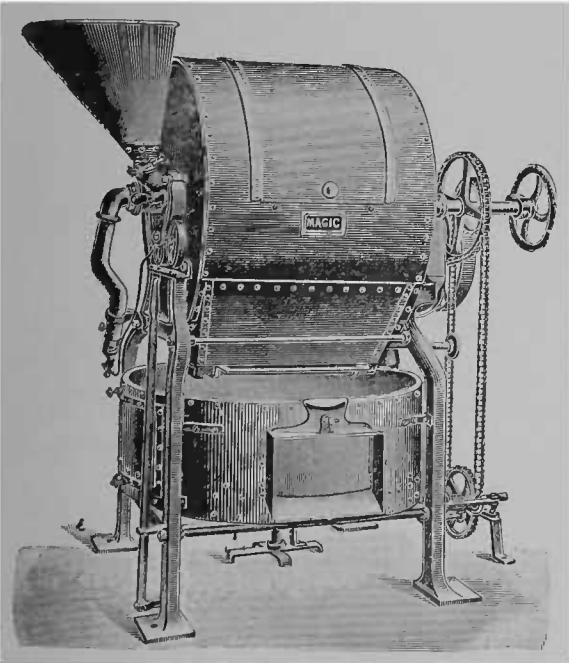




BRITISH ROASTING AND GRINDING EQUIPMENT

Showing a 168-pound "Simplex" gas roaster, with a "Rapid" disk grinding machine.

the one patented by Chris Abele, of New York, already referred to, were construc-



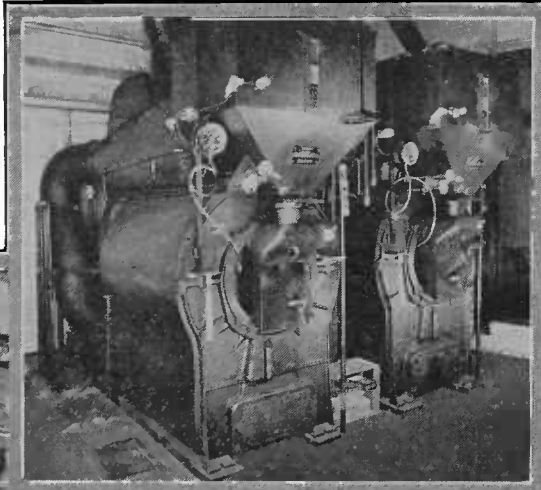
"MAGIC" GAS MACHINE (FRENCH)

tions resulting from the expiration of the original Burns patent of 1864. In 1881, Jabez Burns patented the improved Burns roaster, comprising a turn-over front head serving for both feeding and discharging. Additional United States coffee-roaster patents were issued to G. W. Hungerford in 1887-89. In the latter year, David Fraser, who came to the United States from Glasgow in 1886, established the Hungerford Co., succeeding the business of the Hungerfords, and later being granted certain United States patents already mentioned. In 1910, the Hungerford Co. business was discontinued in New York; and David B. Fraser moved to Jersey City where he continued to operate as the Fraser Manufacturing Co. The business was discontinued in 1918.

Chris Abele was an active competitor of the Hungerfords and of the Fraser Manufacturing Co.; and his Knickerbocker roaster was sold over a wide territory. He died in 1910; and his son-in-law, Gottfried Bay, succeeded to the business.

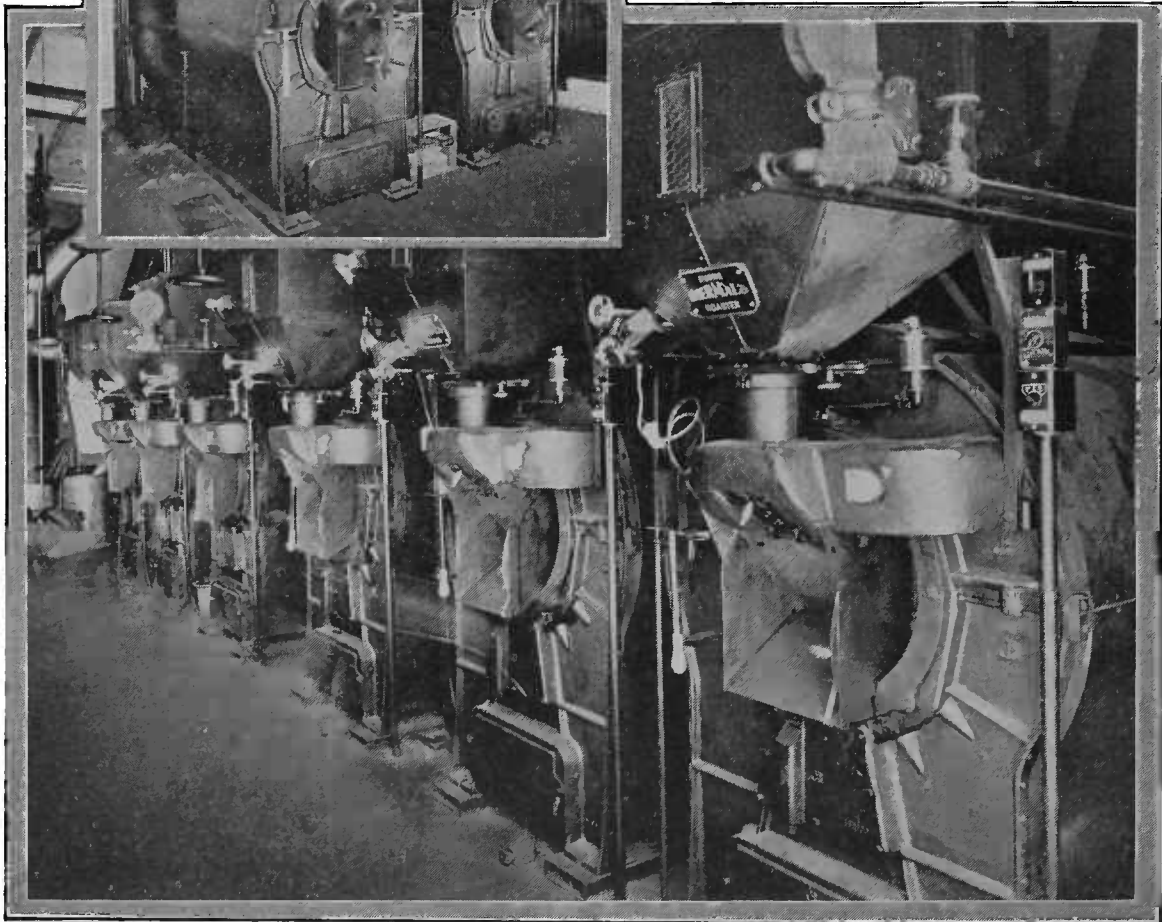
In 1881, the Morgan Brothers, Edgar H.

## BATTERY OF MODERN ROASTERS IN A MODEL AMERICAN PLANT



*At left:* Two 500-pound capacity coffee roasters with the new "Thermalo" apparatus for low temperature processing.

*Below:* A battery of six "Thermalo" machines of 300 pounds capacity each. The installation includes two additional 500-pound units not shown in the illustration, making a total of ten roasters with a combined daily capacity of 100,000 pounds.



THE ROASTING ROOM IN THE FACTORY OF THE EPPENS, SMITH CO., INC., NEW YORK

and Charles, began the manufacture of household coffee mills, the business being acquired in 1885 by the Arcade Manufacturing Co., of Freeport, Ill. The latter concern brought out the first pound coffee mill in 1889. Its mills became very popular in the United States. In 1900, Charles Morgan was granted a United States patent on a glass-jar coffee mill, with removable glass measuring cup.

In 1881, Harvey Ricker, of Brooklyn, later of Minneapolis, introduced to the trade in the United States a "minute coffee

pot and urn" known as the "Boss," the name being subsequently changed to "Minute." He improved and patented the device in 1901 as the "Half-Minute" coffee pot. It is a filtration device employing a cotton sack with a thickened bottom.

In 1882, Chris Abele, of New York, patented an improvement on the old-style Burns roaster, with openings cut in the front plate. It was known as the "Knickerbocker." As already noted, the machine was a competitor of the Hungerford machine patented the same year.

In 1882, a German patent was granted to Emil Newstadt, of Berlin, on one of the earliest coffee-extract machines.

In 1883, Jabez Burns was granted a United States patent on his improved sample-coffee roaster.

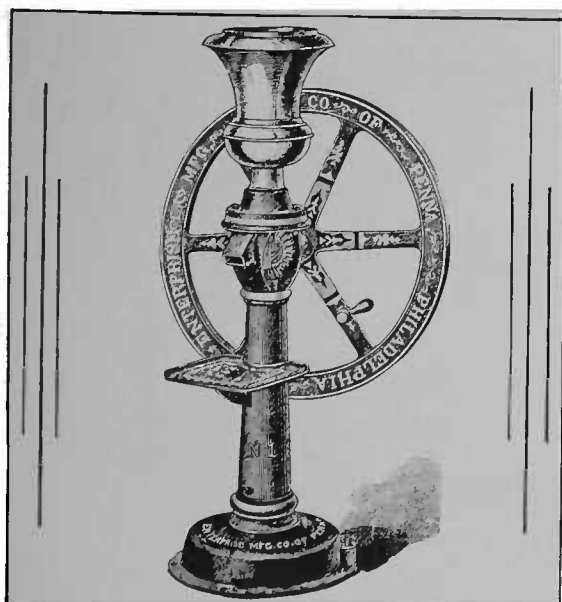
In 1884, the Star coffee pot, later known as the Marion Harland, was introduced to the trade. It employed a wire-gauze drip device, called a "filter," which was fitted to a metal pot. It was extensively advertised and attained considerable popularity. The same year, Finley Acker, of Philadelphia, brought out an improved coffee pot for family trade. Later, he produced his "Mo-Kof-Fee" pot and an individual porcelain drip pot for testing-table use.

In 1885, F. A. Cauchois, New York, brought out an improved porcelain-lined urn.

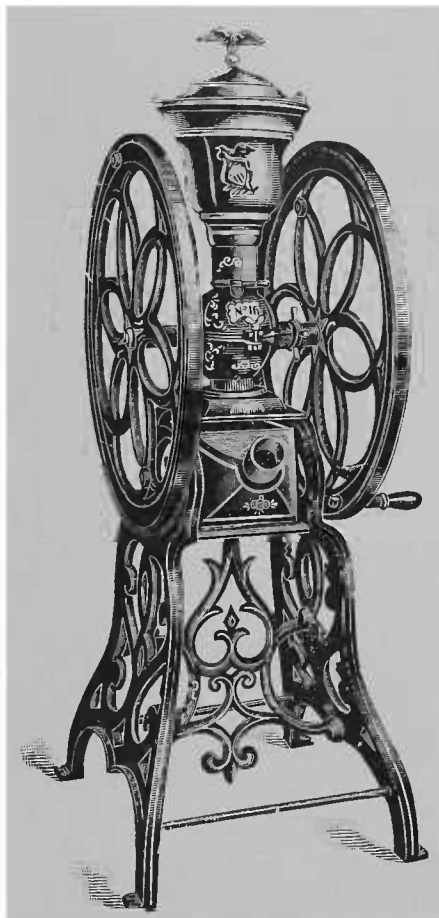
In 1887-88, the "Etruscan" coffee pot was invented and put on the market by the Etruscan Coffee Pot Co., of Philadelphia. It employed a muslin cylinder with metal ends and a mechanism for combining "agitation, distillation, and infusion." It was not unlike the Dakin device of 1848, previously mentioned.

In 1890, A. Mottant, Bar-le-Duc, France, began to manufacture a line of coffee-roasting machinery which included vertical ball-and-cylinder machines, using wood, coal, coke, or gas for fuel. His best known makes are "Magic" and "Sirocco" (see pages 607 and 611).

Before 1895, the commercial roaster was



THE ORIGINAL "ENTERPRISE" MILL, 1870

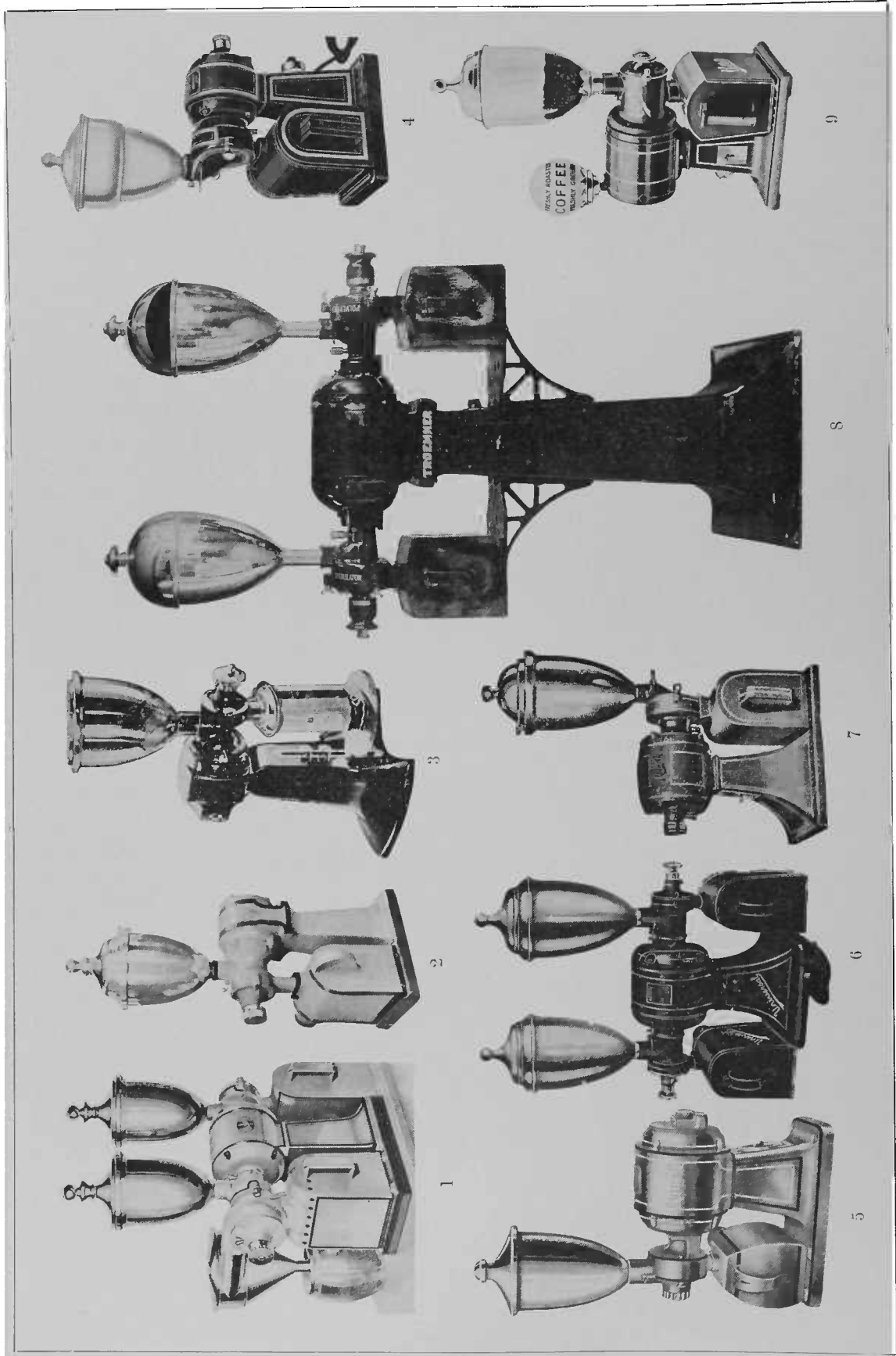


THE "ENTERPRISE" PIONEER HAND STORE MILL

little used in France. Since then, the industry has developed, but without displacing the smaller roaster for family use. Ball roasters are popular with shopkeepers, especially the variety manufactured by the Établissements Lauzaune at Paris, and known as Aromatic, being equipped with electric motors. This firm builds also a larger machine known as Moderne.

Other makes of roasters that have attained prominence in France are the Lambert, equipped with a steam condenser; Van den Brouck's, having the roasting cylinder lined with wire gauze; and Resson's machine for wholesale plants.

The French led off with glass-cylinder roasters for home use in the early seventies. They are still popular. One of the developments of the last decade was known as the "Bijou," and was operated by clock work. A similar automatic machine, made of glass, was manufactured and sold in New York in 1908 under the name of the "Home" roaster. As late as 1914, an American inventor produced a home roaster for use in a stove hole. This device had a



LATEST TYPES OF ELECTRICALLY-DRIVEN STORE COFFEE-GRINDING MILLS  
 1—Hobart Combination Coffee Grinder and Refiner. 2—Cleveland "Kleen-Kut." 3—"American Duplex." 4—"Royal." 5—"Enterprise." 6—"Universal" double-ended mill. 7—Holwick. 8—Troemner. 9—"Uno," British mill.

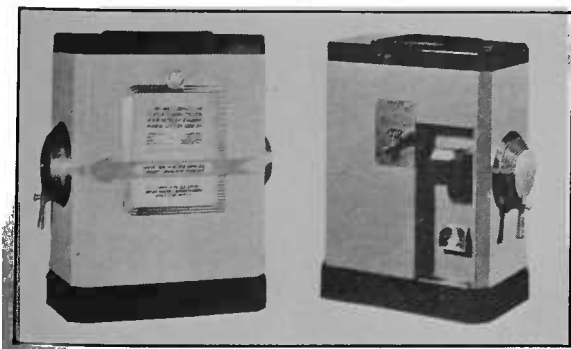
stirrer in the cover to be rotated by hand. A similar device was sold in 1917 under the name "Savo." Home roasting, however, has become a lost art in America.

In 1897, Joseph Lambert, of Vermont, began the manufacture and sale in Battle Creek, Mich., of the Lambert self-contained coffee roaster without the brick setting then required for coffee-roasting machines. In 1900, he was joined by A. P. Grohens. In 1901, the Lambert Food and Machinery Co. was organized. In 1904, the company was re-organized, and in 1931 the business was acquired by the Bauer Brothers Company of Springfield, O. The Lambert gas roaster, one of the first machines employing gas as fuel for indirect roasting, dates back to 1901, as previously mentioned. The "Economic" roaster is a compact self-contained equipment operating in connection with a new-type rotary cooler. In 1922, a gas-fired, electrically operated 600-pound Victory roaster and a fifty-pound miniature coffee-roasting plant designed for retail stores were brought out.

In 1897, the Enterprise Manufacturing Co. of Pennsylvania was the first regularly to employ electric motors for driving commercial coffee mills by means of belt-and-pulley attachments.

In 1898, the Hobart Manufacturing Co., of Troy, Ohio, introduced to the trade another early coffee grinder connected with an electric motor and driven by belt-and-pulley attachment.

In 1900, the first gear-driven electric coffee grinder was put on the market by the Enterprise Manufacturing Co. of Pennsylvania.



NEW TYPE OF STORE COFFEE MILL

This electric grinder, introduced by the Great Atlantic and Pacific Tea Company, is a distinct departure from the usual store mill both in appearance and construction. *Left*, front or customers' side. *Right*, back or operating side, grinding directly into the bag or can.



ONE OF THE FIRST ELECTRIC COFFEE MILLS

In 1902, the Coles Manufacturing Co., (Braun Co., successor) and Henry Troemer, of Philadelphia, began the manufacture and sale of gear-driven electric coffee grinders.

In 1905, the A. J. Deer Co., Buffalo, N. Y. (now Royal Electric Fixture Corporation), began to sell coffee mills direct to dealers on the instalment plan, revolutionizing the former practice of selling coffee mills through hardware jobbers.

In 1905, H. L. Johnston was granted a United States patent on a coffee mill. He assigned the patent to the Hobart Manufacturing Co.

In 1900, Charles Lewis was granted a United States patent on an improved reversible filtration coffee pot known as the "Kin-Hee." This pot has since been further improved, and the patent rights sold in several foreign countries. It employs a filter cloth in place of the metal or china strainer used in the French drip pot.

In 1901, Landers, Frary & Clark's improved "Universal" percolator was patented in the United States. This pot has proved to be one of the most popular percolators on the American market. This firm brought out the "Universal Cafe-noira," a double glass filtration device, in



1916. It is covered by design and structural patents issued in 1916 and 1917.

In 1900, the Burns swing-gate sample-roasting outfit was patented in the United States.

In 1901, Robert Burns, of New York, was granted two United States patents on a coffee roaster and cooler.

In 1901, Freidrich Kuchelmeister, Brux, Austria-Hungary, was granted a United States patent on a coffee roaster having a double-walled drum, the inner being of wire gauze, and the outer of solid iron, designed to prevent scorching of the beans.

In 1902, W. M. Still & Sons, London, were granted an English patent on a steam coffee-making machine employing twelve ounces of coffee to the gallon.

In 1902, T. K. Baker, of Minneapolis, was granted two United States patents on a cloth-filter coffee-making device.

In 1903, A. E. Bronson, Jr., assignor to the Bronson-Walton Company, Cleveland, Ohio, was granted a United States patent on a coffee mill.

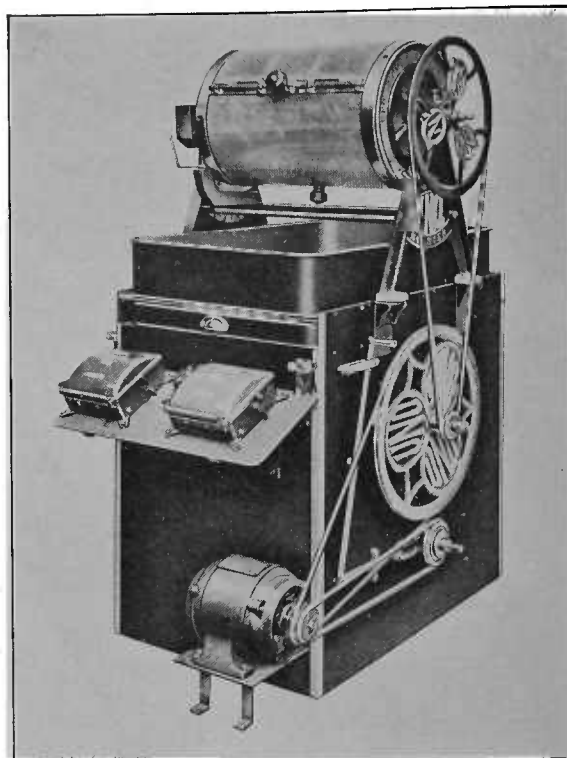
In 1903, John Arbuckle was granted a United States patent on a coffee-roasting apparatus employing a fan to force the hot fire gases into the roasting cylinder. From this was developed the Jumbo roaster, now used in the Arbuckle plant, which roasts ten thousand pounds an hour.

#### *Electric Coffee-Roasting*

In 1903, George C. Lester, of New York, was granted a United States patent on an electric coffee roaster, that is, a machine to roast by electric heat. There were two cylinders, the inner being of wire gauze, and the outer of copper and asbestos. Between the two, four electric heaters were placed.

There was demonstrated in Germany, in 1906, an electric coffee roaster employing a number of resistance coils, consisting of strips of Krupp metal two and one-half mm. thick, five mm. broad, and thirteen and one-half mm. long, wound on porcelain tubes, which transmitted the heat to the air within the roasting cylinder. Analysis showed that coffee electrically roasted contained more substances soluble in water than that roasted by coke, as well as considerably more material soluble in ether. This machine was invented by Captain Carl Moegling about 1900.

Another electric-fuel-machine patent was



THE "UNO" ELECTRIC-FUEL ROASTER AND COOLER

granted in the United States to Robert H. Talbutt, of Baltimore, in 1911. This machine had the electric heater in the center of the roasting cylinder. An electrically heated machine called the Ben Franklin was demonstrated in New York in 1918.

In 1919, Everett T. Shortt, Dallas, Tex., was granted a United States patent on an electrical roaster.

Up to the present writing, no great progress has been made in the United States with the roasting of coffee by electric heat.

The Phoenix Electrical Heating Co. manufactured, and the Uno Company, Ltd., of London, marketed an electrically heated roaster as far back as 1909. The machine was not altogether satisfactory, even to the makers; and the Uno Company is now (1935) manufacturing a new type of electric roaster. The 1909 roaster was made of two concentric cylinders revolving around a set of fixed heating elements, consisting of a series of spiral wires held in position on fireproof clay insulators, these wires being assembled, insulated, and brought out through the fixed center to a terminal, or a set of terminals, at one end. In this way, no contact brushes or rings were needed. The machine had a sampling device at one end

which threw out a few berries each time it was operated. It was not possible to return these sample berries. Such an arrangement appeared necessary, however, unless one was prepared to have the heating element on the outside of the machine and to pick up the current by means of rings or brushes. When the operator became accustomed to the coffee he was roasting, this was not a matter of great moment, because in England, at least, the average coffee roaster does not require a testing sample until he is about ready to turn out and to cool the roast.

The Uno electric roasting and cooling unit of today has its electrical elements closely wound in spiral form on a carrier mounted centrally in the inner cylinder, the coffee being inclosed between the cylinder and the outer drum, so as to absorb all of the heat generated. Because of the design, a wide diffusion of heat of lower temperature is obtained close to the coffee, in order to overcome the objection to the old type, where the heat was concentrated in a number of local positions.

In 1921, a United States patent was granted to Mark T. Seymour, Stowe, N. Y., on an electric coffee and peanut roaster, which has the heating element embedded in a cement-lined cylinder that contains a roasting cage.

In 1921, Fred J. Kuhlemeir and Ralph J. Quelle, of Burlington, Ia., were granted a United States patent on a small household coffee roaster electrically equipped, and roasting by electric heat.

#### *Other Machinery Patents*

In 1903, Luigi Giacomini, of Florence, Italy, was granted a United States patent on a process for roasting coffee.

In 1905, A. A. Warner, assignor to Landers, Frary & Clark, New Britain, Conn., was granted two United States patents on a coffee mill.

In 1906, Ludwig Schmidt, assignor to the Essmuller Mill Furnishing Co., St. Louis, was granted a United States patent on a coffee roaster. This company and the Reuter-Jones Manufacturing Co., also of St. Louis, were making machines similar to the original Burns model. The Reuter-Jones Manufacturing Co., in 1910, brought out a self-contained gas roaster called the St. Louis, Jr. In 1913, at a receiver's sale, A. P. Grohens, of the Lambert Machine Co., acquired all the machinery and patent

rights of the Reuter-Jones Manufacturing Company.

In 1904 J. W. Chapman and G. W. Kooman, assignors to Manning, Bowman & Co., Meriden, Conn., were granted a United States patent on a coffee or tea pot. The same year, George E. Savage and G. W. Hope were granted two United States patents on coffee or tea pots, also assigned to Manning, Bowman & Co.

In 1904, Sigmund Sternau, J. P. Steppe, and L. Strassberger, assignors to S. Sternau & Co., New York, were granted a United States patent on a percolator. Six others were granted to Charles Nelson, and assigned to S. Sternau & Co., in 1912 and 1913, for a percolator, the manufacture and sale of which were discontinued in 1915.

In 1905, a celebrated case was decided in Kansas City involving litigation between William E. Baker, of Baker & Co., Minneapolis, and the F. A. Duncombe Manufacturing Co., of St. Joseph, Mo., over Mr. Baker's patent rights in a machine to produce steel-cut coffee. The suit was brought in 1903, and Mr. Baker contended that his patent gave him the exclusive right to the "uniformity of granules by means of the sharply dressed mechanism" and by the use of a fan for blowing away the silver skins, produced by his machine; while the defendant said he obtained the same result (steel-cut coffee) by grading the granules through screens or sieves. The defense was that Mr. Baker's process was not a discovery; because, grinding coffee was as old as the chaff was equally ancient. The lower court dismissed the bill, because the "patents sued upon are devoid of patentable invention"; and the United States Court of Appeals confirmed the decision.

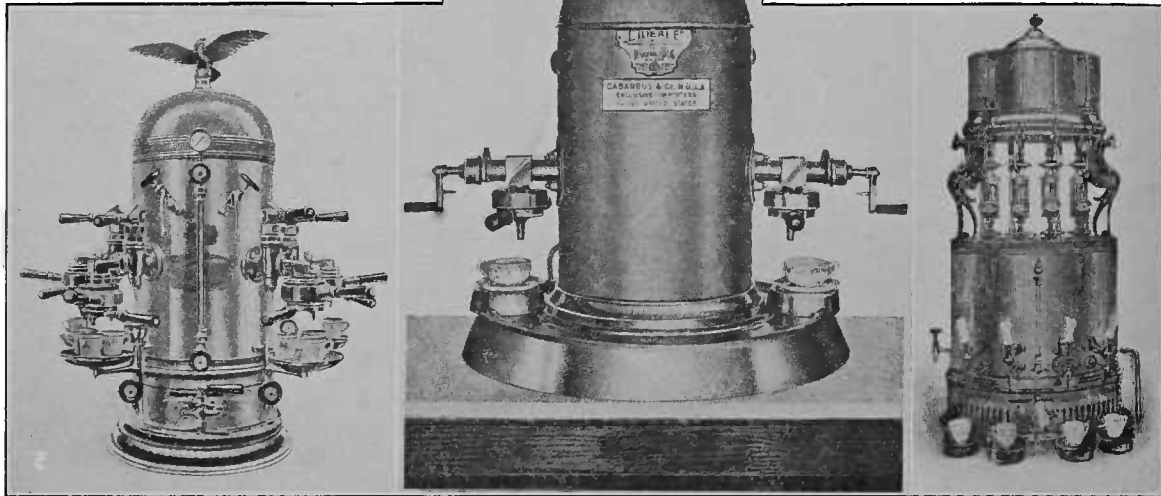
In 1905, Frederick A. Cauchois, of New York, brought out his "Private Estate" coffee maker, a clever combination of the French drip and filter processes, employing a thin layer of Japanese paper as a filtering agent. The same year, Finley Acker, of Philadelphia, was granted a United States patent on a percolator employing two cylinders, perforated on the sides, with a sheet of percolator paper placed between them to act as a filtering medium.

In 1906, George Savage and J. W. Chapman, assignors to Manning, Mowman & Co. of Meriden, Conn., were granted a United States patent on a coffee percolator.

In 1906, Alonzo A. Warner, assignor to Landers, Frary & Clark, New Britain,

THE "IDEALE" MACHINE (CENTER) MAKES 150 CUPS OF COFFEE AN HOUR. THE MACHINE AT THE LEFT MAKES 1,000 CUPS AN HOUR

A MACHINE OF THE TYPE OF THE ONE AT THE RIGHT WILL PRODUCE FROM 1,440 TO 1,800 CUPS OF COFFEE AN HOUR



TYPES OF ITALIAN RAPID COFFEE-MAKING MACHINES

Conn., was granted a United States patent on a coffee percolator.

In 1906, H. D. Kelly, Kansas City, was granted a United States patent on the Kellum Automatic coffee urn, employing a coffee extractor in which ground coffee is continually agitated before percolation by a vacuum process. Sixteen patents followed.

In 1907, Desiderio Pavoni, of Milan, Italy, was granted a patent in Italy for an improvement on the Bezzara system for preparing and serving coffee as a rapid infusion of a single cup, first introduced in 1903-1904. It is known as the "Ideale" urn, and makes 150 cups per hour. Among other Italian rapid coffee-making machines which, with this one, have attained considerable prominence in Europe and South America, mention should be made of "La Victoria Arduino," made by Pier Teresio Arduino, of Turin, Italy, introduced in 1909, that makes 1,000 cups per hour. It was patented in the United States in 1920. Also, "L'Italiana Sovereign" filter machine, 1,440 cups per hour, formerly made by Bossi, Vernetti & Bartolini, Turin, (subsequently merged with La Victoria Arduino-Societa Anonima); and José Baro's "Express," Buenos Aires, making 600 cups an hour.

In 1908, A. E. White, Chicago, was

granted a United States patent on a coffee urn. He assigned it to the James Heekin Co., of Cincinnati.

In 1908, I. D. Riehheimer, Chicago, introduced his "Tricolator" to the trade and the consumer. This is an aluminum device fitted to a coffee pot, combining French drip and filtration ideas, with Japanese paper as the filtration medium.

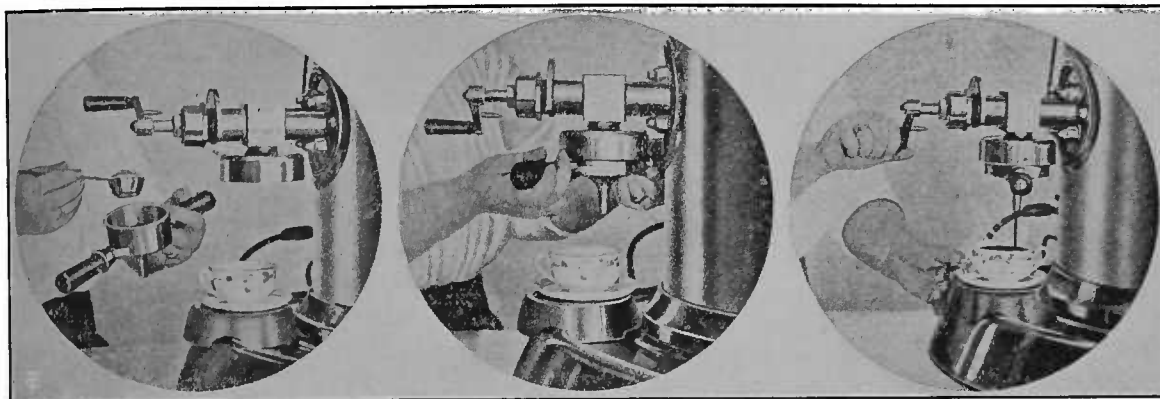
In 1908, an improved type of Burns roaster was patented in the United States. The improvement consisted of an open perforated cylinder with flexible back-head and balanced front bearing. The following year, the Burns tilting sample-roaster for gas or electric heating units was patented.

In 1909, Frederick A. Cauchois, of New York, was granted a United States patent on a coffee urn fitted with a centrifugal pump for repouring.

In 1909, C. F. Blanke, of St. Louis, was granted two United States patents on a china coffee pot with a cloth filter, the sides tightly, and the bottom loosely, woven.

In 1911, Edward Aborn, of New York, was granted a United States patent on his "Make-Right" coffee-filter device. This was later incorporated with improvements in a "Tru-Bru" coffee pot, on which he was granted another patent in 1920.

In 1912, John E. King, of Detroit, was



SHOWING HOW THE "IDEALE" ITALIAN RAPID COFFEE MACHINE WORKS  
*Left*, putting coffee in the filter—*Center*, applying filter to faucet—*Right*, turning on water and steam to make the drink.

granted a United States patent on an improved coffee percolator for restaurants, employing a sheet of filter paper on a ring in a metal basket; the ring to be removed once the filter paper was in position on the perforated bottom plate of the percolator basket.

In 1913, F. F. Wear, Los Angeles, perfected a coffee-making device in which a metal perforated clamp was employed to apply a filter paper to the under-side of an English earthenware adaptation of the French drip pot.

In 1912, William Lawton demonstrated in London a gas coffee roaster of his own invention, by means of which he roasted coffee "in suspension" to a light-brown color in three minutes.

Herbert L. Johnston, assignor to the Hobart Electric Manufacturing Co., Troy, Ohio, was granted a United States patent on a machine for refining coffee in 1913.

In 1914, the "Phylax" coffee maker, embodying an improvement on the French drip principle, was introduced to the trade. The process was demonstrated by Benjamin H. Calkin, of Detroit, in 1921, as "an art of brewing coffee."

In 1914, Robert Burns, assignor to Jabez Burns & Sons, New York, was granted a United States patent on a coffee-granulating mill.

In 1914-15, Herbert Galt, of Chicago, was granted three United States patents on the Galt coffee pot, made of aluminum, and having two parts, a removable cylinder employing the French drip principle and the containing pot.

In 1915, the Burns "Jubilee" (inner-heated) gas coffee roaster was patented in

the United States and put on the market.

In 1915, the National Coffee Roasters' Association "Home" coffee mill, employing an improved set screw operating on a cog-and ratchet principle, was introduced to the trade.

In 1916, a United States patent was granted to I. D. Richheimer, Chicago, for



"LA VICTORIA" ARDUINO MIGNONNE  
 Italian electric rapid coffee maker.

an infuser improvement on his Tricolator.

In 1916, Saul Blickman, assignor to S. Blickman, New York, was granted a United States patent on an apparatus for making and dispensing coffee.

In 1916, Orville W. Chamberlain, New Orleans, was granted a United States patent on an automatic drip coffee pot.

In 1916, Jules Le Page, Darlington, Ind., obtained two United States patents on cutting rolls to cut—and not to grind or crush—corn, wheat, or coffee. These were subsequently incorporated in the "Ideal" steel-cut coffee mill and marketed to the trade by the B. F. Gump Co., Chicago.

In 1917, Richard A. Greene and William G. Burns, assignors to Jabez Burns & Sons, New York, were granted patents in the United States on the Burns flexible-arm cooler for roasted batches, providing full fan-suction to a cooler box at all points in its track travel.

In 1919, Joseph F. Smart, assignor to Landers, Frary & Clark, New Britain, Conn., was granted a United States patent on a percolator.

In 1919, Charles Morgan, assignor to the Arcade Manufacturing Co., Freeport, Ill., was granted a United States patent on an improved grinding mill.

In 1919, Edward F. Schnuck, assignor to Jabez Burns & Sons, New York, was granted a United States patent on an improvement for a gas coffee roaster. In 1920, he was granted a United States patent on an improved process of twice cutting coffee and removing the chaff after each cutting.

In 1920, Natale de Mattei, of Turin, Italy, was granted a United States patent on a rapid coffee-filtering machine.

In 1920, Frederick H. Muller, of Chicago, was granted a United States patent on "an art of making coffee," and on an improved apparatus for hotels and restaurants, which comprised a series of superposed metal containers, or cartridges, of ground coffee placed in a perforated bucket designed to rest in a coffee urn, the cartridges being lifted out as the boiling water poured on them sinks with the drawing off of the "decoction" at the faucet.

In 1920, Alfredo M. Salazar, of New York, was granted a United States patent on a coffee urn in which the coffee is made at the time of serving by using steam pressure to force the boiling water through

ground coffee held in a cloth sack attached to the faucet.

In 1920, William H. Bruning, Evansville, Ind., was granted a United States patent on an improved French drip pot made of aluminum and provided with a vacuum jacket in the dripper section, and a hot-water jacket in the serving portion, to keep the beverage hot.

In 1921, the Manthey-Zorn Laboratories Co., of Cleveland, brought out a rapid coffee-infuser and dispenser employing in the infuser a centrifugal to make an extract in thirty-eight seconds, and designed to deliver a gallon of concentrated liquid, or coffee base, every three minutes. The dispenser automatically combines the coffee base with boiling water in a differential faucet in the proportion desired, usually one of base to four of water. The dispenser serves 600 cups per hour. An additional faucet may be added which will double the capacity.

Among foreign coffee makers applying the French drip principle, the Vienna coffee-making machine, known in the United States as the Bohemian coffee pot, has met with much favor in this country. Elsewhere it is known as the Carlsbad. It is made of china, and the European manufacturer has a patent on the porcelain strainer, or grid, which is provided with slits that are very fine on the inner side but that widen on the outer side to permit careful straining and to facilitate cleaning.

#### *Recent United States Patents*

In 1922, Lewis S. Baker of Ossining, N. Y., was granted a U. S. patent on a two-piece vacuum-type, automatic coffee maker, somewhat on the order of the glass ones commonly used by restaurateurs and others today. He assigned the patent to Western Electric Co., New York. In the same year Gilbert Rathbone, New York, patented an external device for repouring urn coffee, utilizing air pressure for the purpose; Henry Roselius, Amsterdam, Holland, took out a U. S. patent on a process for removing caffeine from raw coffee beans; and Louis Angel Romero, San Francisco, patented a process for making coffee extract.

In 1923, Leland S. Meade patented a multiple-cylinder roaster through which coffee was fed intermittently, being first pre-heated, roasted, and cooled in its travel



through the cylinders; Edward Aborn, East Orange, N. J., was granted a patent on a filter coffee pot; a coffee infuser, open at the top and having a perforated bottom, for brewing individual cups of coffee, was patented by Isaac D. Richheimer, New York; and Michael Angel Villavicentio, Caracas, Venezuela, patented a machine for drying coffee.

In 1924, Cyrus F. Blanke, St. Louis, patented a coffee pot; John V. Wells, New York, an automatic re-pouring urn; J. C. H. Grant, Kiti-Muru, East Africa, a coffee-pulping machine; Coffee Products Corporation, New York, process for preparing caffeine-free coffee beans; Hobart Manufacturing Co., Troy, O., coffee grinder; and Albert P. Grohens, Marshall, Mich. two coffee roasters.

U. S. coffee patents issued in 1925 included the following: William A. Lamb, Everett, Mass., assignor to Silex Co., Malden, Mass., a coffee-making device in combination with a heating medium; Francis P. McColl, Ridgewood, N. J., and Walter W. Willison, Brooklyn, assignors to Thermokept Corp. of Delaware, soluble tablet of pure, roasted coffee; Theodore Miller, Brooklyn, a drip coffee pot; Robert O. Bingham, assignor to Wagner Manufacturing Co., Sidney, O., a coffee percolator; Ernest H. Still, London, Eng., coffee-making apparatus in which water from a boiler under pressure is forced through the bottom of an infuser; George H. Peal, Rutherford, N. J., an individual perforated coffee infuser with a string and tag, like a tea bag, for its removal from the liquid; and Columbia Enameling & Stamping Co., Terre Haute, Ind., drip coffee pot.

In 1926, Charles B. Parker, Nashville, patented a percolator coffee pot, and Stephen P. Enright, Philadelphia, a coffee or teapot that whistles an alarm if the beverage reaches the boiling point.

Among the 1927 coffee patents were: Gorham Manufacturing Co., Providence, an electric percolator; Fritz Kündig, Wallisellen, Switzerland, process for the production of caffeine-free coffee by subjecting whole coffee beans to a pressure of 15 atmospheres in the presence of a solvent for caffeine; Sloss Perfect Coffee Makers, Inc., New York, a coffee urn combination; and Compact Coffee Corporation, Delaware, a coffee tablet.

In 1928, the following were some of the U. S. coffee patents granted: Isaac D. Rich-

heimer, New York, the non-drizzle coffee pot spout which has since become familiar on "Tricolator" coffee pots; Charles E. Page, Los Angeles, a drip coffee pot; Charles P. Randolph, Oak Park, Ill., assignor to Edison Electric Appliance Company, Chicago, an electric percolator with the electric unit projecting upward into its interior in order to hasten percolation; and Albert W. Meyer, New York, an individual-cup coffee-brewing device; Leo Wertheimer, Buffalo, coffee leacher.

The 1929 coffee patents included among many others: Henry Marcuson, Chicago, a coffee-urn combination; William A. Rankin, Rochester, N. Y., assignor to Robeson-Rochester Corporation, Rochester, an improved coffee percolator, and Frederick J. Cross, Rochester, assignor to Robeson-Rochester Corporation, an electric base for a coffee percolator; William M. Williams, assignor to B. F. Gump Co., Chicago, a coffee granulator; Angelo Torriani, Pavia, Italy, a large-output "Express" coffee machine; John N. Shaw, Seattle, improved coffee urn; and John Peter Pauly, assignor to Measure-Rite Co., Kansas City, a cake coffee.

The 1930 coffee patents included: Edward Aborn, East Orange, N. J., a filter coffee pot; John P. Halstead and Herman M. Alfred Strauss, Rochester, assignor to Robeson-Rochester Corporation, a percolator improvement consisting of a small well or cup in the bottom of the pot for more rapid ebullition of the water supplied to the fountain percolator tube, the lower end of which rested loosely in the well or cup; Richard F. Krause, Massillon, O., an improved drip-coffee maker; Angelo Torriani, Pavia, Italy, an improvement on the filter device on the "Express" coffee urn; Richard F. Krause, Massillon, O., drip-coffee maker; Edward Aborn, East Orange, N. J., coffee pot construction, coffee-brewing apparatus, and process of coffee extraction; Isaac D. Richheimer, improved coffee holder for "Tricolator" pot, with binder plate on top of coffee, and with a perforated bottom upon which rests a filter medium.

In 1931, Bauer Brothers Company, Springfield, O., patented a coffee-grinding mill; Isaac D. Richheimer, New York, improved coffee percolator; Walter S. Marvin, Two Rivers, Wis., assignor to Metal Ware Corporation, electric percolator; Karl Lendrich, et al., Hamburg, Germany, pro-

cess for improving coffee beans by decomposing the chlorogenic acid; Richard S. Iglehart, Springfield, O., assignor to the Bauer Brothers Company, a coffee-grinding mill with a rotary pivoted hammer having grooves and teeth on its free ends; and Albert W. Meyer, New York, a percolator receptacle open at top and bottom, and adapted to have its lower end set into a coffee pot.

In 1932, William L. Klug, Chicago, was granted a U. S. patent on a washable electric percolator, having a detachable heating unit; Joseph F. Lamb, New Britain, Conn., assignor to Landers, Frary & Clark, a self heating coffee percolator; Edward Sieling, Chicago, coffee-bag ring with bail for lifting; Richard F. Krause, Massillon, O., a drip-coffee maker; Eugene G. Berry and Horace G. Woodhead, Chicago, assignors to B. F. Gump Co., coffee-cutting mill with rolls, screen, and means for removing chaff and tailings, with a device for returning the tailings to the rolls; and Irving W. Wood, New Kensington, Pa., assignor to the Aluminum Cooking Utensil Co., a drip coffee pot with perforated coffee container.

In 1933, William J. Livingston, Chicago, patented a self-clarifying coffee, coated with egg albumen; Harry C. Bates, assignor to Corning Glass Works, Corning, N. Y., an all-glass percolator; Joseph F. Quinn, assignor to Geo. W. Caswell & Co., San Francisco, coffee roasting process by which a single flat layer of coffee beans is passed downwardly over a heated surface, with the beans continually turning over; Kirk E. Porter, assignor to The Buckeye Aluminum Co., Wooster, O., drip-coffee maker; Joseph F. Lamb, assignor to Landers, Frary & Clark, New Britain, Conn., an improved electric percolator; Charles

E. Page, Los Angeles, a drip-coffee maker; Raymond W. Kell and Charles D. Barth, assignor to Macbeth-Evans Glass Co., Charleroi, Pa., an improved vacuum-type apparatus for making coffee; Elizabeth Woodward, Chicago, coffee pot with a flattened face and holder for a slice of toast; and Arthur D. Nash, assignor to The Libby Glass Manufacturing Co., Toledo, O., a glass coffee pot.

In 1934, Edward J. Dent, assignor to American Coffee Corporation, Brooklyn, method of roasting coffee; Nathaniel B. Wales, New York, immersion-type coffee brewer, to be inserted into a receptacle filled with water; Howard R. Hall, Chicago, compressed-coffee tablet; Earl M. Evleth, assignor to Bastian-Blessing Co., Chicago, coffee urn; Perry A. De Groot, Philadelphia, compound drip coffee pot; Edward H. Sieling, Chicago, urn bag; Albert C. Wilcox, assignor to the Enterprise Aluminum Co., Massillon, O., automatic electric drip-coffee maker; Isaac D. Richheimer, New York, a coffee retainer and water spreader of plastic material; Harvey C. Corey, Chicago, vacuum-type coffee brewer; Frank E. Wolcott, assignor to the Silex Co., Hartford, vacuum-type coffee maker; Edward J. Dent, assignor to American Coffee Corporation, New York, roasting apparatus; Horace G. Woodhead, assignor to the B. F. Gump Co., Chicago, coffee granulator; René C. Sawyer, assignor to Bridgeport Brass Co., an automatic percolator; Geo. D. Macbeth, assignor to Macbeth-Evans Glass Co., Pittsburgh, vacuum-type coffee maker; Frank E. Wolcott, assignor to the Silex Co., Hartford, vacuum-type coffee maker; Harold K. Wilder, assignor to Kellogg Co., Battle Creek, process for decaffeinating coffee beans; and Henry T. Mustonen, Little Neck, N. Y., automatic roaster apparatus.



## CHAPTER XXXVI

### PREPARATION OF THE BEVERAGE

THE EVOLUTION OF GRINDING AND BREWING METHODS—COFFEE WAS FIRST A FOOD, THEN A WINE, A MEDICINE, A DEVOTIONAL REFRESHMENT, A CONFECTION, AND FINALLY A BEVERAGE—BREWING BY BOILING, INFUSION, PERCOLATION, AND FILTRATION—COFFEE MAKING IN EUROPE IN THE NINETEENTH CENTURY—EARLY COFFEE MAKING IN THE UNITED STATES—LATEST DEVELOPMENTS IN BETTER COFFEE MAKING—VARIOUS ASPECTS OF SCIENTIFIC COFFEE BREWING.

THE coffee drink has had a curious evolution. It began, not as a drink, but as a food ration. Its first use as a drink was as a kind of wine. Civilization knew it first as a medicine. At one stage of its development, before it became generally accepted as a liquid refreshment, the berries found favor as a confection. As a beverage, its use probably dates back about six hundred years.

The protein and fat content of coffee, so far as civilized man is concerned, is an absolute waste. The only constituents that are of value are water soluble, and can be extracted readily with hot water. When coffee is properly made, as by the drip method, either by percolation or filtration, the ground coffee comes in contact with the hot water for only a few minutes; so the major portion of the protein, which is not only practically insoluble, but coagulates on heating, remains in the unused coffee grounds. The coffee bean contains a large per cent of protein—fourteen per cent. By comparing this figure with twenty-one per cent of protein in peas, twenty-three per cent in lentils, twenty-six per cent in beans, twenty-four per cent in peanuts, about eleven per cent in wheat flour, and less than nine per cent in white bread, we learn how much of this valuable food stuff is lost with the coffee grounds.<sup>1</sup>

Though civilized man, excepting the inhabitants of the Isle de Groix off the coast of Brittany, does not use this protein content of coffee as a food, in certain parts of

Africa it has been put to such use from time immemorial. James Bruce, the Scottish explorer, in his travels to discover the source of the Nile in 1768-73, found that this curious use of the coffee bean had been known for centuries. He brought back accounts and specimens of its use as a food in the shape of balls made of grease mixed with roasted coffee finely ground between stones.

Other writers have told how the Galla, a wandering tribe of Africa—and like most wandering tribes, a warlike one—find it necessary to carry concentrated food on their long marches. Before starting on their marauding excursions, each warrior equips himself with a number of food balls. These prototypes of the modern food tablet are about the size of a billiard ball, and consist of pulverized coffee held in shape with fat. One ball constitutes a day's ration; and although civilized man might find it unpalatable, from the purely physiological standpoint it is not only a concentrated and efficient food, but it also has the additional advantage of containing a valuable stimulant in the caffeine content which spurs the warrior on to maximum effort. And so the savage in the African jungle has apparently solved two problems; the utilization of coffee's protein, and the production of a concentrated food.

Further research shows that perhaps as early as A. D. 800 this practice started by crushing the whole ripe berries, beans, and hulls, in mortars; mixing them with fats; and rounding them into food balls. Later, the dried berries were so used. The in-

<sup>1</sup> Frankel, F. Hulton, Ph.D. *Tea and Coffee Trade Jour.*, 1917 (vol. xxxii: p. 142).

habitants of Groix, also, thrive on a diet that includes roasted coffee beans.

About A. D. 900, a kind of aromatic wine was made in Africa from the fermented juice of the hulls and pulp of the ripe berries.<sup>2</sup>

Payen says that the first coffee drinkers did not think of roasting but, impressed by the aroma of the dried beans, they put them in cold water and drank the liquor saturated with their aromatic principles. Crushing the raw beans and hulls, and steeping them in water, was a later improvement.

It appears that boiled coffee—the name is anathema to-day—was invented about the year A. D. 1000. Even then, the beans were not roasted. We read of their use in medicine in the form of a decoction. The dried fruit, beans and hulls, were boiled in stone or clay cauldrons. The custom of using the sun-dried hulls, without roasting, still exists in Africa, Arabia, and parts of southern Asia. The natives of Sumatra neglect the fruit of the coffee tree and use the leaves to make a tea-like infusion. The leaves are roasted and ground to a fine powder. Jardin relates that in Guiana an agreeable tea is made by drying the young buds of the coffee tree, and rolling them on a copper plate slightly heated. In Uganda, the natives eat the raw berries; from bananas and coffee they make also a sweet, savory drink which is called *meng-hai*.

About 1200, the practice was common of making a decoction from the dried hulls alone. There followed the discovery that roasting improved the flavor. Even today, this drink known as Sultan or Sultana coffee, *café à la sultane*, or *kisher*, continues in favor in Arabia. Credit for the invention of this beverage has been wrongfully given by various French writers to Doctor Andry, director of the Faculty of Medicine in Paris. Dr. Andry had his own recipe for making *café à la sultane*, which was to boil the coffee hulls for half an hour. This gave a lemon-colored liquid which was drunk with a little sugar.

The Oriental procedure was to toast the hulls in an earthenware pot over a charcoal fire, mixing in with them a small quantity of the silver skins, and turning them over until they were slightly parched. The hulls and silver skins, in proportions of

<sup>2</sup> See chapter II.



EARLY COFFEE MAKING IN PERSIA

Showing leather bag for green beans, roasting plate, grinder, boiler, and serving cups

four to one, were then thrown into boiling water and well boiled again for at least a half-hour. The color of the drink had some resemblance to the best English beer, La Roque assures us, and it required no sweetening, "there being no bitterness to correct." This was still the coffee drink of the court of Yemen, and of people of distinction in the Levant, when La Roque and his fellow-travelers made their celebrated voyage to Arabia the Happy in 1711-13.

The practice of roasting the dried beans, after the hulling process, started some time in the thirteenth century. This was done first in crude stone and earthenware trays, and later on metal plates, as described in chapter XXXV. A liquor was made by boiling the whole roasted beans. The next step was to pound the roasted beans to a powder with a mortar and pestle; and the decoction was then made by throwing the powder into boiling water, the drink being swallowed in its entirety, grounds and all. Coffee was a decoction for the next four centuries.

When the long-handled, Arabian metal boiler made its appearance in the early part of the sixteenth century, the method of preparation and service was greatly improved. The Arabs and the Turks made

it a social adjunct, its use being no longer confined to physicians and churchmen. It became a stimulating refreshment for all the people; and at the same time, the Arabians and the Turks developed a coffee ceremony for the higher classes which was quite as wonderful as the tea ceremony of Japan.

The common early method of preparation throughout the Levant was to steep the powder in water for a day, boil the liquor half away, strain it, and keep it in earthen pots for use as wanted. In the sixteenth century, the small coffee boiler, or *ibrik*, caused the practice to be more of an instantaneous affair. The coffee was ground, and the powder was dropped into boiling water, to be withdrawn from the fire several times as it boiled up to the rim. While still boiling, cinnamon and cloves were sometimes added before pouring the liquid off into the *fin-djans*, or little china cups, to be served with the addition of a drop of essence of amber. Later, the Turks added sugar while boiling.

From the first simple uncovered *ibrik* there was developed, about the middle of the seventeenth century, a larger-size covered coffee boiler, the forerunner of the modern combination brewing and serving pot. This was a copper-plated kettle patterned after the oriental ewer with a broad base, bulbous body, and narrow neck. After having poured into it one and a half times as much water as the dish (cup) in which the drink was to be served would hold, the pot was placed on a lively fire. When the water boiled, the powdered coffee was tossed into the pot; and, as the liquid boiled up, it was taken from the fire and returned, probably a dozen times. Then the pot was placed in hot ashes to permit the grounds to settle. This done, the drink was served. Dufour, describing this process as practised in Turkey and Arabia, says:

One ought not to drink coffee, but suck it in as hot as one can. In order not to be burned, it is not necessary to place the tongue in the cup but hold the edge against the tongue with the lips above and below it, forcing it so little that the edges do not bear down, and then suck in; that is to say, swallow it sip by sip. If one is so delicate he can not stand the bitterness, he can temper it with sugar. It is a mistake to stir the coffee in the pot, the grounds being worth nothing. In the Levant it is only the scum of the people who swallow the grounds.

La Roque, in *Voyage del Arabie*, says:

The Arabians, when they take their coffee off the fire, immediately wrap the vessel in a wet cloth which fines the liquor instantly, makes it cream at the top and occasion a more pungent steam, which they take great pleasure in snuffing up as the coffee is pouring into the cups. They, like all other nations of the East, drink their coffee without sugar.

Some of the Orientals afterward modified the early coffee-making procedure by pouring boiling water on powdered coffee in the serving cups. They thus obtained "a foaming and perfumed beverage," says Jardin, "to which we [the French] could not accustom ourselves because of the powder which remains in suspension. Nevertheless, clarified coffee may be obtained in the Orient. In Mecca, in order to filter it, they strain it through stopples of dried herbs, put into the opening of a jar."

Sugar seems to have been introduced into coffee in Cairo about 1625. Veslingius records that the coffee drinkers in Cairo's three thousand coffee houses "did begin to put sugar in their coffee to correct the bitterness of it," and that "others made sugar plums of the coffee berries." This coffee confection later appeared in Paris, and about the same time (1700) at Montpellier was introduced a coffee water; "a sort of *rosa-folis* of an agreeable scent that has somewhat of the smell of coffee roasted." These novelties, however, were designed to please only "the most nice lovers of coffee"; for *ennui* and boredom demanded new sensations then as now.

Boiling continued the favorite method of preparing the beverage until well into the eighteenth century. Meanwhile, we learn from English references that it was the custom to buy the beans of apothecaries, to dry them in an oven, or to roast them in an old pudding dish or frying pan before pounding them to a powder with mortar and pestle, to force the powder through a lawn sieve, and then to boil it with spring water for a quarter of an hour. The following recipe from a rare book published in London, 1662, details the manner of making coffee in the seventeenth century:

#### COFFEE MAKING IN 1662

To make the drink that is now much used called coffee.

The coffee-berries are to be bought at any Druggist, about three shillings the pound; take what quantity you please, and over a charcoal



fire, in an old pudding-pan or frying-pan, keep them always stirring until they be quite black, and when you crack one with your teeth that it is black within as it is without; yet if you exceed, then do you waste the Oyl, which only makes the drink; and if less, then will it not deliver its Oyl, which must make the drink; and if you should continue fire till it be white, it will then make no coffee, but only give you its salt. The Berry prepared as above, beaten and forced through a Lawn Sieve, is then fit for use.

Take clean water, and boil one-third of it away what quantity soever it be, and it is fit for use. Take one quart of this prepared Water, put in it one ounce of your prepared coffee, and boil it gently one-quarter of an hour, and it is fit for your use; drink one-quarter of a pint as hot as you can sip it.

In England, about this time, the coffee drink was not infrequently mixed with sugar candy, and even with mustard. In the coffee houses, however, it was usually served black, without sugar or milk.

About 1660, Nieuhoff, the Dutch ambassador to China, was the first to make a trial of coffee with milk in imitation of tea with milk. In 1685, Sieur Monin, a celebrated doctor of Grenoble, France, first recommended *café au lait* as a medicine. He prepared it thus: Place on the fire a bowl of milk. When it begins to rise, throw into it a bowl of powdered coffee, a bowl of moist sugar, and let it boil for some time.

We read that in 1669 "coffee in France was a hot black decoction of muddy grounds thickened with syrup."

Angelo Rambaldi in his *Ambrosia Arabica* thus describes coffee making in Italy and other European countries in 1691:

DESCRIPTION OF THE VASE FOR MAKING THE  
DECOCTION, DOSE OF POWDER AND OF THE  
WATER NECESSARY AND TIME OF  
BOILING IT.

Two such vessels having a large paunch to reach the fire, two others with long necks and narrow, with a cover to restrain their spirituous and volatile particles which when thrown off by the heat are easily lost. These vessels are called Ibriq in Arabia. They are made of copper—coated with white outside and inside. We, who do not possess the art of making them should select an earth vitriate, sulphate of copper, or any other material adapted for kitchen ware: it might even be of silver.

The quantity of water and powder has no certain rule, by reason of the difference of our nature and tastes, and each one after some experience will use his own judgment to adjust it to his desire and liking.

Maronita infused two ounces of powder in three litres of water. Cotovico in his voyage to Jerusalem affirms that he has observed six ounces of the former to 20 litres of the latter, boiled until it was reduced to half the quantity.

Thévenot asserts that the Turks in three cups of water are contented with a good spoonful of powder. I have observed however that in Africa, France and England, into about six ounces of water (which with them is one cup) a dram of the powder is infused and this agrees with my taste—but I have wished at times to change the dose.

Others put the water into the vase and when it begins to boil add the powder, but because it is full of spirit at the first contact with the heat it rises and boils over the edge of the vase. Take it away from the fire till the boiling ceases, then put it on the fire again and let it stay a short time boiling with the cover on: Stand it on warm ashes until it settles, after which slowly pour a little of the decoction into an earthen vessel, or one of porcelain or any other kind, as hot as can be borne, and drink a sip; if it pleases your taste, add a portion of cardamom, cloves, nutmeg or cinnamon, and dissolve a little sugar in the water; yet because these substances will alter the taste of this simple, they are not prized by many experts.

Modern Arabia, Bassa, Turkey, the Great Orient, those who are travelling or in the army, infuse the powder in cold water, and then boiling it as directed above, bear witness to its efficacy. All times are opportune to take this salutary drink (beverage). Among the Turks are those who take it even by night, nor is there a business meeting or conversation, where coffee is not taken. Among the Great it would be accounted an incivility, if with smoke, coffee were not offered: and no one in the day is ashamed to frequent the bazaars where it is sold. When I was in London, that city of three million people, there were taverns for its special use. It is a great stimulant. The sober take it to invigorate the stomach. The scrofulous hated it because they thought it stirred up the bile on an empty stomach—but experience proving the contrary enjoy it as much as others.

In 1702, coffee in the American colonies was being used as a refreshment between meals, "like spirituous liquors."

It was in 1711 that the infusion idea in coffee making appeared in France. It came in the form of a fustian (cloth) bag which contained the ground coffee in the coffee maker, and the boiling water was poured over it. This was a decided French novelty, but it made slow headway in England and America, where some people were still boiling the whole roasted beans and drinking the liquor.

In England, as early as 1722, there arose a conscientious objector to boiled coffee in the person of Humphrey Broadbent, a coffee merchant who wrote a treatise on *the True Way of Preparing and Making Coffee*, in which he condemned the "silly" practice of making coffee by "boiling an ounce of the powder in a quart of water," then common in the London coffee houses, and urging the infusion method.

He favored the following procedure :

Put the quantity of powder you intend, into your pot (which should be either of stone, or silver, being much better than tin or copper, which takes from it much of its flavour and goodness) then pour boiling-hot water upon the aforesaid powder, and let it stand to infuse five minutes before the fire. This is an excellent way, and far exceeds the common one of boiling, but whether you prepare it by boiling or this way, it will sometimes remain thick and troubled, after it is made, except you pour in a spoonful or two of cold water, which immediately precipitates the more heavy parts at the bottom, and makes it clear enough for drinking.

Some, make coffee with spring water, but it is not so good as river, or *Thames*-water, because the former makes it hard, and distasteful, and the other makes it smooth and pleasant, lying soft on the stomach. If you have a desire to make good coffee in your families, I cannot conceive how you can put less than two ounces of powder to a quart, or one ounce to a pint of water; some put two ounces and a quarter.<sup>3</sup>

By 1760, the decoction, or boiling, method in France had been generally replaced by the infusion, or steeping, method.

In 1763, Donmartin, a tinsmith of St. Bedit, France, invented a coffee pot, the inside of which was "filled by a fine sack put in in its entirety," and which had a tap to draw the coffee. Many inventions to make coffee *sans ebullition* (without boiling) appeared in France about this time; but it was not until 1800 that De Belloy's pot, employing the original French drip method, appeared, signaling another step forward in coffee making—percolation.

#### *De Belloy and Count Rumford*

De Belloy's pot probably was made of iron or tin, afterward of porcelain; and it has served as a model for all the percolation devices that followed it for the next hundred years. It does not seem to have been patented, and not much is known of the inventor. About this period, it was the common practice in England to boil coffee in the good old-fashioned way, and to "fine" (clarify) it with isinglass. This moved Count Rumford (Benjamin Thompson), an American-British scientist, then living in Paris, to make a study of scientific coffee-making, and to produce an improved drip device known as Rumford's percolator. He has been generally credited with the invention of the percolator; but, as pointed out in a previous chapter, this

<sup>3</sup> Broadbent Humphrey. *The Domestic Coffee Man*, London, 1722.

honor seems to be De Belloy's and not Rumford's.

Count Rumford embodied his observations and conclusions in a verbose essay entitled *Of the excellent qualities of coffee and the art of making it in the highest perfection*, published in London in 1812. In this treatise he describes and illustrates the Rumford percolator.

Brillat-Savarin, the famous French gastronomist, who also wrote on coffee in his *Vime Meditation* said of the De Belloy pot:

I have tried, in the course of time, all methods and of all those which have been suggested to me up to today (1825), and with a full knowledge of the matter in hand, I prefer the De Belloy method, which consists of pouring the boiling water upon the coffee which has been placed in the vessel of porcelain or silver, pierced with very small holes. I have attempted to make coffee in a boiler at high pressure, but I have had as a result a coffee full of extracts and bitterness which would scrape the throat of a Cossack.

Brillat-Savarin had something also to say on the subject of grinding coffee, his conclusion being that it was "better to pound the coffee than to grind it."

He refers to M. Du Belloy, archbishop of Paris, "who loved good things and was quite an epicure," and says that Napoleon showed him deference and respect. This may have been Jean Baptiste De Belloy, who, according to Didot, was born in 1709 and died in 1808, and, it is thought likely was the inventor of the De Belloy pot.

Count Rumford was born in Woburn, Mass., in 1753. He was apprenticed to a storekeeper in Salem in 1766. He became an object of distrust among the friends of the cause of American freedom; and, on the evacuation of Boston by the Royal troops in 1776, he was selected by Governor Wentworth of New Hampshire to carry dispatches to England. He left England in 1802, and resided in France from 1804 until his death in 1814. In 1772, he had married, or rather, as he put it, he was married by, a wealthy widow, the daughter of a highly respectable minister and one of the first settlers at Rumford, now called Concord, New Hampshire. It was from this town that he took his title of Rumford when he was created a Count of the Holy Roman Empire in 1791. His first wife having died, he married in Paris the wealthy widow of the celebrated chemist, Lavoisier; and with her he lived an ex-

tremely uncomfortable life until they agreed to separate.

In his essay on coffee and coffee making, Count Rumford gives us a good pen picture of the preparation of the beverage in England at the beginning of the nineteenth century. He says:

Coffee is first roasted in an iron pan, or in a hollow cylinder, made of sheet iron, over a brisk fire; and when, from the colour of the grain, and the peculiar fragrance which it acquires in this process, it is judged to be sufficiently roasted, it is taken from the fire, and suffered to cool. When cold it is pounded in a mortar; or ground in a hand-mill to a coarse powder, and preserved for use.

Formerly, the ground Coffee being put into a coffee-pot, with a sufficient quantity of water, the coffee-pot was put over the fire, and after the water had been made to boil a certain time, the coffee-pot was removed from the fire, and the grounds having had time to settle, or having been fined down with isinglass, the clear liquor was poured off, and immediately served up in cups.

Count Rumford thought it a mistake to agitate the coffee powder in the brewing process, and in this he agreed with De Belloy. His improvement on the latter's pot is described in chapter XXXV. He was a coffee connoisseur; and as such was one of the first to advocate the use of cream as well as sugar for making an ideal cup of the beverage. He refers, though not by name, to De Belloy's percolation method and says, "Its usefulness is now universally acknowledged."

#### *A Few Definitions*

Just here, in order to assure a better understanding of the subject, it may be well to clear up sundry misconceptions regarding the words percolation, filtration, decoction, infusion, etc., by the simple expedient of definition.

A decoction is a liquid produced by boiling a substance until its soluble properties are extracted. Thus the coffee drink was first a decoction; and a decoction is what one gets today when coffee is boiled in the good old-fashioned way—as "mother used to make it."

Infusion is the process of steeping—extraction without boiling. It is extraction accomplished at any temperature below boiling, and is a general classification of procedure capable of sub-division. As generally and correctly applied, it is the operation wherein hot water is merely

poured upon ground coffee loose in a pot, or in a container resting on the bottom of the pot. In the strictest sense of the term, an infusion is also produced by percolation and filtration, when the water is not boiled in contact with the coffee.

Percolation means dripping through fine apertures in china or metal as in De Belloy's French drip pot.

Filtration means dripping through a porous substance, usually cloth or paper.

Percolation and filtration are practically synonymous, although a shade of distinction in their meaning has arisen, so that often the latter is considered as a step logically succeeding the former. Accomplishing extraction of a material by permitting a liquid to pass slowly through it is in fact percolation, whereas filtration of the resultant extract is effected by interposing in its path some medium which will remove solid or semi-solid material from it. Coffee-making practice has in itself so applied these terms that each is considered a complete process. Percolation is thus applied when the infusion is removed from the grounds immediately by dripping through fine perforations in the china or metal of which the device is constructed.

True percolation is not produced in the pumping "percolators," in which the heated water is elevated and sprayed over ground coffee held in a metal basket in the upper part of the pot; the liquor being recirculated until a satisfactory degree of extraction has been reached. Rather, the process is midway between decoction and infusion, for the weak liquor is boiled during the operation in order to furnish sufficient steam to cause the pumping action.

Filtration is accomplished when the ground coffee is retained by cloth or paper, generally supported by some portion of the brewing device, and extraction effected by pouring water on the top of the mass, permitting the liquid to percolate through, the filtering medium retaining the grounds.

#### *Patents and Devices*

From the beginning, the French devoted more attention than any other people to coffee brewing. The first French patent on a coffee maker was granted in 1802 to Denobe, Henrion, and Rauch for "a pharmacological-chemical coffee making device by infusion."

In 1802, Charles Wyatt obtained a patent in London on an apparatus for distilling coffee.

The first French patent on an improved French drip pot for making coffee "by filtration without boiling" was granted to Hadrot in 1806. Strictly speaking, this was not a filtering device, as it was fitted with a tin composition strainer, or grid. It was very like Count Rumford's percolator announced six years later, as will be seen by comparing illustrations of the two in chapter XXXV.

In 1815, *Sené*, invented in France his *Cafetière Sené*, another device to make coffee "without boiling."

About the year 1817, the coffee biggin appeared in England. It was simply a squat earthenware pot with an upper, movable, strainer part made of tin, after the French drip pot pattern. Later models employed a cloth bag suspended from the rim of the pot. It was said to have been invented by a Mr. Biggin; and Dr. Murray, of dictionary fame, seems to have become convinced of this gentlemen's existence, although others have doubted it and thought the name was of Dutch origin, the article having been first made for Holland. It has been suggested that, in all probability, the name came from the Dutch word *beg-gelin*, to-trickle, or run down. One thing is certain, coffee biggins came originally from France; so that if there was a Mr. Biggin, he merely introduced them into England. The coffee biggin with which Americans are most familiar is a pot containing a flannel bag or a cylindrical wire strainer to hold the ground coffee through which the boiling water is poured. The "Marion Harland" pot was an improved metal coffee biggin. The "Triumph" coffee filter was a cloth-bag device which made any coffee pot a biggin.

In 1819, Morize, a Paris tinsmith, invented a double drip, reversible coffee pot. The device had two movable "filters" and was placed bottom up on the fire until the water boiled, when it was inverted to let the coffee "filter" or drip through.

In 1819, Laurens was granted a French patent on the original pumping-percolator device, in which the water was raised by steam pressure and dripped over the ground coffee.

In 1820, Gaudet, another Paris tinsmith, invented a filtration device that employed a cloth strainer.

In 1822, Louis Bernard Rabaut was granted an English patent on a coffee-making device in which the usual French drip process was reversed by the use of steam pressure to force the boiling water upward through the coffee mass. Case-neuve, of Paris, was granted a patent on a similar device in France in 1824.

In 1825, the first coffee-pot patent in the United States was granted to Lewis Martelley on a machine "to condense the steam and essential oils and return them to the infusion."

In 1827, the first really practicable pumping percolator, as we understand the term today, was invented by Jacques-Augustin Gandais, a manufacturer of plated jewelry in Paris. The boiling water was raised through a tube in the handle and sprayed over the ground coffee suspended in a filter basket, but could not be returned for a further spraying.

In 1827, Nicholas Felix Durant, a manufacturer of Chalons-sur-Marne, was granted a French patent on a "percolator" employing, for the first time, an inner tube to raise the boiling water for spraying over the ground coffee.

In 1839, James Vardy and Moritz Platow were granted an English patent on a kind of urn "percolator," or filter, employing the vacuum process of coffee making, the upper vessel being made of glass.

By this time, the pumping percolator, working by steam pressure and by partial vacuum, was in general use in France, England, and Germany. And then began the movement toward the next stage in coffee making—filtration.

About 1840, Robert Napier (1791-1876) the Scottish marine engineer, of the celebrated Clyde shipbuilding firm of Robert Napier & Sons, invented a vacuum coffee machine to make coffee by distillation and filtration. The device was never patented; but thirty years later, it was being made in the works of Thomas Smith & Son (Elkington & Co., Ltd., successors) under the direction of Mr. Napier, the aged inventor. The device consists of a silver globe, brewer syphon, and strainer (see page 631). It operates as follows: a half-cupful of water is put into the globe, and the gas flame is lighted. The dry coffee is put into the receiver, which is then filled up with boiling water. This will at once become agitated, and will continue so for a few minutes. When it becomes still, the gas flame is



EARLY EUROPEAN AND AMERICAN COFFEE-MAKING DEVICES

1—English adaptation of French boiler. 2—English coffee biggin. 3—Improved Rumford percolator. 4—Jones's exterior-tube percolator. 5—Parker's steam-fountain coffee maker. 6—Platow's filterer. 7—Brain's vacuum, or pneumatic filter. 8—Beart's percolator. 9—American coffee biggin. 10—Cloth-bag drip pot. 11—Vienna coffee pot. 12—Le Brun's cafetière. 13—Reversible Potsdam cafetière. 14 and 15—Gen. Hutchinson's percolator and urn, combining De Belloy's and Rumford's ideas. 16—Etruscan biggin.



turned down, and clear coffee is syphoned over into the globe through the syphon tube, on the end of which, as it rests in the coffee liquid, there is a metal strainer covered with a filter cloth.

The Napierian coffee machine has enjoyed great popularity in England. The principle has in later years been incorporated in the Napier-List steam coffee machine for use in hotels, ships, restaurants, etc. Steam is used as a source of heat, but does not mix with the coffee. List's patent is for an improvement on the Napierian system and was granted in 1891.

It is related that shortly before he died, old Mr. Napier, at the termination of a dispute in Smith & Co.'s factory at Glasgow, where the device was being made under his instruction, said to old Mr. Smith: "You may be a guid silversmith, but I am a better engineer."

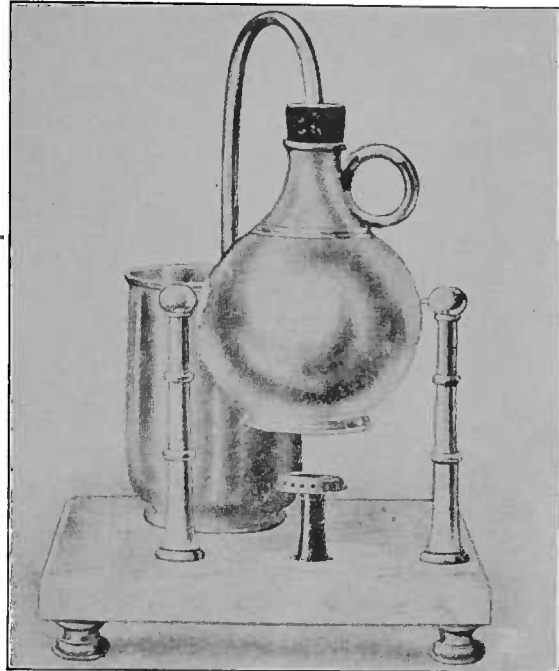
In 1841, William Ward Andrews was granted an English patent on an improved pot employing a pump to force the boiling water through the ground coffee while contained in a perforated cylinder screwed to the bottom of the pot.

In 1842, the first French patent on a glass coffee-making device was granted to Madame Vassieux of Lyons.

Following this, there were numerous patents issued in France and England on double glass-globe coffee-making devices. They were first known as double glass balloons, and most of them employed metal strainers.

After this, there were many "percolator" patents in France, England, and the United States, some of which were for improved forms of the original drip method of the De Belloy device. Others were for the type of machine which came to be known as "percolators" because they employed the principle of raising the heated water and spraying it over the ground coffee in continuous fashion. The story is told in chronological order in the chapter on the evolution of coffee apparatus; so it is not necessary to repeat it here. Numerous filtration devices also were produced abroad and in the United States.

Among the percolators, those of Manning, Bowman & Co., and of Landers, Frary & Clark, became well known here. In the filtration field, the following attained considerable distinction: Harvey Ricker's Half-Minute pot, employing a cotton sack with re-inforced bottom, introduced about 1881; the Kin-Hee pot of



NAPIER VACUUM COFFEE MAKER

1900; Cauchois' Private Estate coffee maker, using Japanese filter paper, introduced in 1905; Finley Acker's percolator, introduced the same year, which also employed a filter paper between two cylinders having side perforations; the "Tricolorator," 1908; King's percolator, using filter paper, in 1912; and the "Make-Right," 1911, with its adaptation as presented in the "Tru-Bru pot" of 1920.

The "Make-Right" was the invention of Edward Aborn, New York, and comprised two telescoping open wire frames, or baskets, with a flat piece of muslin between them. In the "Tru-Bru pot," the same idea was employed, except that the wire frames were so constructed as to furnish four drip points to afford better distribution on the ground coffee and to lessen the time of filtration. There was also a porcelain top, to house and to raise the filtration device, above the brew with an opening through which the boiling water could be poured without exposing the ground coffee.

Among later developments of the genuine percolator principle that have attracted attention in this country, mention should be made of the "Phylax" coffee maker, and the "Galt" pot.

In 1914-16, there was a revival of interest in the United States in the double glass-globe or vacuum method of making coffee, introduced into France as "double



GROUP OF HOUSEHOLD COFFEE MAKERS USED IN UNITED STATES

For description see opposite page.

glass balloons" in the first half of the nineteenth century. American ingenuity has produced several clever adaptations, and several notable filter improvements. Advertising has developed a great demand for these vacuum-type glass coffee makers—as they are generally known today—for both restaurant and home use. At first, the problem of keeping the beverage properly heated after brewing proved a serious obstacle to their adoption in restaurants, but the public liked to see them in operation and liked the coffee they produced, so special gas and electric heaters were soon developed. These brew the coffee quickly and then maintain its temperature at not less than 175° nor more than 190° F. Within this range of temperature coffee stays fresh for some time, and there is no loss of aroma by boiling. This has been a great advantage, as it permits advance preparation for the rush hours.

Vacuum-type glass coffee makers also are widely sold for home use, where they met no such preliminary obstacle as they did in public places, because it is not usually necessary to keep hot coffee on draft in the home over long periods. Coffee makers of the home type employ gas or electricity as heating agents. Among the well-known home and commercial makes are: the "Silex," "Vaculator," "Vis-a-Vac," "Thermex," etc.

Within the last few years, it has become the fashion to obtain patents in the United States on "the art of brewing coffee," or the "art of making coffee." Instances are the patents issued to Messrs. Calkin and Muller. In the Calkin patent (the "Phylax") the "art" consists in controlling the flow of the boiling water by means of the number and spacing of the holes in the water-spreader, so as to restrict the volume and the speed, to effect a quick initial extraction; and then, by means of a new spacing of holes in the infuser, retarding the drip "to attain a prolonged extraction of the tannin and other elements of slow extraction and combining the liquids obtained during the initial and subsequent stages of the brew for attaining a balanced liquid extract."

Muller's "art" consisted in so supplying and supporting the ground coffee in an urn that it is never again subjected to "decoction" after having been exposed to the air and steam following the first application of the water.

There has been a considerable advance in the manufacture of household coffee pots in the United States in recent years, particularly the drip or filtration type. The appearance of the coffee makers has been greatly improved, as well as their average of operation efficiency. The group in the illustration on page 632 visualizes the great variety of home coffee brewing devices now available. The models shown include drip, vacuum, percolator and old-fashioned types in aluminum, enameled ware, china ware, and chromium. The models are designated by their trade names, the substance of which they are made and their type, as follows: 1. "Drip-Drop," aluminum drip; 2. "Drip-o-Lator," aluminum drip; 3. "Kewaskum," aluminum drip; 4. "Dripmaster," aluminum drip; 5. "Kitchencraft," aluminum drip; 6. "Revere," chromium drip; 7. "Enterprise," aluminum drip; 8. "G. E.," chromium percolator; 9. "Manning Bowman," chromium percolator; 10. "Universal," aluminum percolator; 11. "Massillon," aluminum drip; 12. "Aluminum Products," aluminum drip; 13. "Royal Rochester," chromium percolator; 14. "Dripette," aluminum drip; 15. "Coffelator," aluminum vacuum; 16. "Chase," chromium drip; 17. "Wearever," regular aluminum percolator; 18. "Wearever," new type aluminum percolator; 19. "Wearever," aluminum drip; 20. "Comet Drip-olator," aluminum drip; 21. "Clear Drip," aluminum drip; 22. "Wearever," aluminum drip; 23. "Drip-o-Lator," china and aluminum drip; 24. "Golden Key," china and aluminum drip; 25. "Royal Granite," coffee pot; 26. "Hall," china drip; 27. "Fraunfelter," china drip; 28. "Hall," early model, china drip; 29. "Coors," porcelain drip; 30. "Tricolator," porcelain and aluminum drip; 31. "Bruette," enamel drip; 32. "Efcolite," china and aluminum drip; 33. "Nesco," enamel drip; 34. "Bon Marché," enamel drip; 35. "Dripette," one-cup aluminum drip; 36. "Becolator," enamel drip; 37. "Columbian," enamel drip; 38. "Porcelier," porcelain percolator; 39. "Tru-Bru," porcelain drip; 40. "Buckeye," one-cup aluminum drip; 41. "Vollrath," enameled drip; 42. "Private Estate," nickel-plated drip; 43. "Bellaire," enamel percolator; 44. "Tricolete," one-cup aluminum drip; 45. "Cream City," enamel percolator.

Another group is shown on the next page.



INDICATING THE VARIETY OF COFFEE BREWING DEVICES UTILIZING GLASS, NOW AVAILABLE

The above group includes most of the glass coffee makers on sale in the United States. Many of them are for both home and restaurant use. The trade names of the models shown are as follows: 1, "Coffeovac"; 2, "Coffeemaster"; 3, "Electrovac"; 4, "Silex"; 5, "G.E."; 6, "Electrobrew"; 7, "Cafelator"; 8, "Westinghouse"; 9, "Crystal-Chef"; 10, "Porostone"; 11, "Zol"; 12, "Vaculator"; 13, "Cafelator" aluminum top; 14, "Percovac"; 15, "Thermex"; 16, "Vis-Vac."

This brief review of the evolution of coffee brews shows that coffee making started with boiling, and next became an infusion. After that, the best practice became divided between simple percolation and filtration, which have continued to the present time. Boiling has also continued to find advocates in every country, even in the United States, where it seems to die hard, no matter how much is done to discredit it. Percolation devices are subdivided into the simple drip pots and the continuous percolation machines, as represented by numerous complicated and high-priced contrivances on the market. Gradually, however, true coffee lovers are realizing that the best results are to be obtained through simple percolation or simple filtration. There are good arguments for both methods.

A survey of American coffee habits in 1932 showed that between 50 and 75 per cent of families in various parts of the U. S. A. were using the pump percolator; 17 to 32 per cent prepared their coffee by boiling; and 5 to 20 per cent use the drip

#### METHODS OF BREWING

Followed by Families in Three Representative Sections of the U. S. A., as Shown in Percentages by a 1932 Survey

Method	Northeastern States %	Middle West %	Pacific Coast %
Percolator	75.51	52.31	58.48
Boil	17.54	32.16	18.50
Drip	5.43	12.79	20.11
Others	1.52	2.74	2.91



"VACULATOR" RESTAURANT COFFEE BREWING SET  
Attractive gas or electric heaters boil the water for brewing and then keep the beverage hot

method. The results of the survey are shown in the accompanying table.<sup>4</sup>

This survey also showed that only a small percentage of the families surveyed in different parts of the country use a heaping tablespoonful of coffee to each cup, which authorities generally agree is the proportion which should be used to obtain the best beverage, irrespective of the type of utensil used for brewing. About 75 per cent of the families used a medium grind of coffee, 20 per cent used fine ground, and 2 per cent coarse. The conclusion reached pointed to great possibilities for promotional work in bettering the

<sup>4</sup>"Survey of American Coffee Habits, Nos. I-IV," *Tea and Coffee Trade Journal*, Jan., 1932, pp. 23-26 and 43; April, 1932, pp. 391-394; July, 1932, pp. 36-37; and Sept., 1932, pp. 250-252.

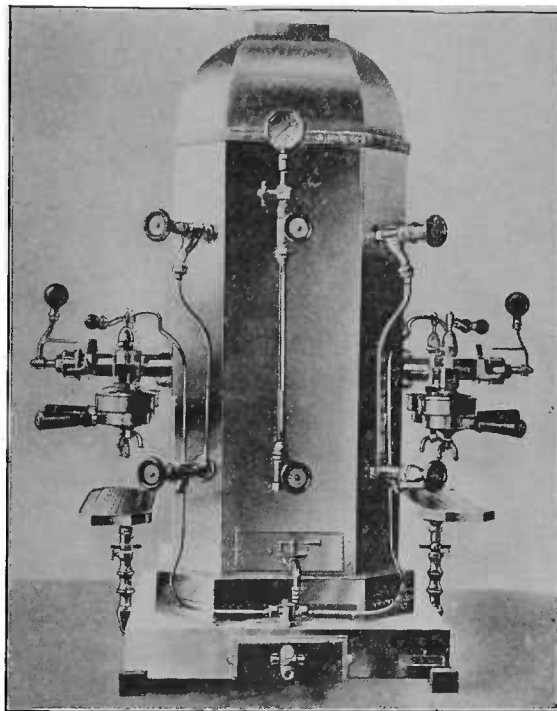


"SILEX" GLASS VACUUM-TYPE RESTAURANT COFFEE MAKER

beverage quality in American homes, and a consequent increase of coffee consumption.

*Commercial Coffee Urns*

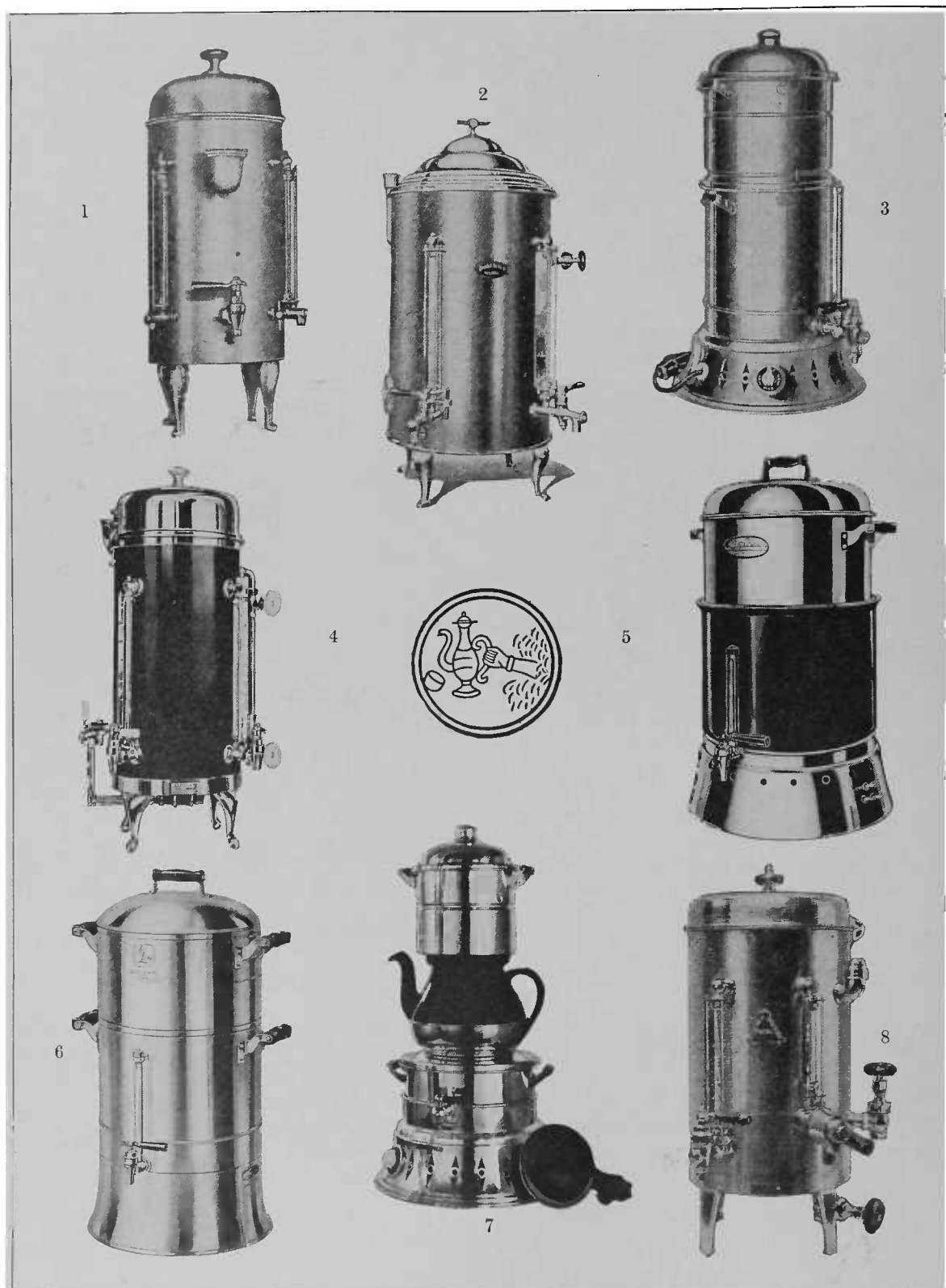
The demands of public caterers for coffee-making and dispensing equipment that is useful and attractive in appearance has been widely met by manufacturers of urns in the U. S. A. and European countries. In America, coffee urns, whether single or inter-connected batteries of two to five, commonly have a lower or main



"LA PAVONI" ITALIAN COFFEE MAKING DEVICE

portion which serves as a boiler for heating the water, with the aid of a large gas burner, and after the water boils it is drawn off and poured over finely ground coffee in a cloth or paper filter placed in the top of the urn. The gas flame is then turned low enough to maintain a temperature of about 175° F. in the coffee infusion which filters back into the lower tank, ready to be drawn off as needed. There are numerous variants of this system used in the United States. For example, where two or more urns are used in combination, some makes segregate the water heating from the coffee brewing urn or urns, and supply hot water separately to an inner brewing tank and an outer water jacket in the latter.





**GROUP OF COMMERCIAL COFFEE BREWING DEVICES IN THE U. S.**

1. Blickman urn. 2. "Ambassador" combination urn. 3. "Tricolator" urn. 4. Bastian-Blessing urn. 5 "Drip-o-Lator" urn. 6. "De Luxe" drip urn. 7. "Tricolator" station-type coffee maker. 8. "Amcoin" glass-lined urn.

Another recent improvement is a non-absorbent glass liner for the beverage tank.

Italy has developed large-capacity coffee urns on an entirely different system, utilizing the urn proper as a boiler to supply steam and hot water under pressure to multiple filtration and dispensing outlets instead of the single spigot familiar in American machines. Each dispensing outlet has a quickly detachable filter into which the correct amount of ground coffee for one cup is measured. A part-turn secures this in place under the dispensing outlet, after which a valve is opened which forces hot water and steam through the ground coffee and into the waiting coffee cup in an instantaneous brew. These machines, which are widely used on the Continent, supply from a hundred and fifty cups an hour in some of the smaller types to over a thousand in the larger ones.

The English favor an automatic, under-the-counter boiler with a coffee-brewing unit on the counter and one or more storage urns for receiving the beverage from the brewing unit; also a faucet to supply freshly boiling water for tea-brewing in individual pots or cups. Among the best-known makes are Still's, Stott's, and Jackson's. Either gas or electricity is employed for heating the water to the boiling point, which is done automatically whenever a tap in the above-counter equipment is turned on. Removable extractors are used for the ground coffee, permitting convenient dumping of exhausted coffee grounds and recharging with fresh coffee and new filter paper.

#### *Coffee Making in Europe in the Nineteenth Century*

ENGLAND. We have noted Count Rumford's efforts to reform coffee making in England in the early part of the nineteenth century. Many other scientific men joined the movement. Among them was Professor Donovan, who in the *Dublin Philosophical Journal* for May, 1826, told of his experiments "to ascertain the best methods for extracting all the virtues inherent in the berry." The *Penny Magazine* for June 14, 1834, after deploring "the straw-colored fluid commonly introduced under the misnomer of coffee in England," thus digests Professor Donovan's findings:

Mr. Donovan found, that what we shall call the medicinal quality of coffee resides in it

independent of its aromatic flavor,—that it is possible to obtain the exhilarating effect of the beverage without gratifying the palate,—and, on the other hand, that all the aromatic quality may be enjoyed without its producing any effect upon the animal economy. His object was to combine the two.

The roasting of coffee is requisite for the production of both these qualities; but, to secure them in their full degree, it is necessary to conduct the process with some skill. The first thing to be done is to expose the raw coffee to the heat of a gentle fire, in an open vessel, stirring it continually until it assumes a yellowish colour. It should then be roughly broken,—a thing very easily done,—so that each berry is divided into about four or five pieces, when it must be put into the roasting apparatus. This, as most commonly used, is made of sheet-iron, and is of a cylindrical shape: it no doubt answers the purpose well, and is by no means a costly machine, but coffee may be very well roasted in a common iron or earthenware pot, the main circumstances to be observed being the degree to which the process is carried, and the prevention of partial burning, by constant stirring. One of the requisites for having good coffee is that it shall have been recently roasted.

Coffee should be ground very fine for use, and only at the moment when it is wanted, or the aromatic flavour will in some measure be lost. To extract all its good qualities, the powder requires two separate and somewhat opposite modes of treatment, but which do not offer any difficulty when explained. On the one hand, the fine flavour would be lost by boiling, while, on the other, it is necessary to subject the coffee to that degree of heat in order to extract its medicinal quality. The mode of proceeding, which, after many experiments, Mr. Donovan found to be the most simple and efficacious for attaining both these ends, was the following:

The whole water to be used must be divided into two equal parts. One half must be put first to the coffee "cold," and this must be placed over the fire until it "just comes to a boil," when it must be immediately removed. Allowing it then to subside for a few moments the liquid must be poured off as clear as it will run. The remaining half of the water, which during this time should have been on the fire, must then be added "at a boiling heat" to the grounds, and placed on the fire, where it must be kept "boiling" for about three minutes. This will extract the medicinal virtue, and if then the liquid be allowed again to subside, and the clear fluid be added to the first portion, the preparation will be found to combine all the good properties of the berry in as great perfection as they can be obtained. If any fining ingredient is used it should be mixed with the powder at the beginning of the process.

Several kinds of apparatus, some of them very ingenious in their construction, have been proposed for preparing coffee, but they are all made upon the principle of extracting only the aromatic flavour, while Professor Donovan's suggestions not only enable us to accomplish that desirable object, but superadd the less obvious but equally essential matter of extracting and making our own all the medicinal virtues.



PEWTER POTS OF THE SEVENTEENTH AND EIGHTEENTH CENTURIES

Left to right, they are German, Flemish, English, and Dutch specimens in the Metropolitan Museum of Art, New York.

When Webster and Parkes published their *Encyclopedia of Domestic Economy*, London, 1844, they gave the following as "the most usual method of making coffee in England":

Put fresh ground coffee into a coffee-pot, with a sufficient quantity of water, and set this on the fire till it boils for a minute or two; then remove it from the fire, pour out a cupful, which is to be returned into the coffee-pot to throw down the grounds that may be floating; repeat this, and let the coffee-pot stand near the fire, but not on too hot a place, until the grounds have subsided to the bottom; in a few minutes the coffee will be clear without any other preparation, and may be poured into cups; in this manner, with good materials in sufficient quantity, and proper care, excellent coffee may be made. The most valuable part of the coffee is soon extracted, and it is certain that long boiling dissipates the fine aroma and flavour. Some make it a rule not to suffer the coffee to boil, but only to bring it just to the boiling point; but it is said by Mr. Donovan that it requires boiling for a little time to extract the whole of the bitter, in which he conceives much of the exhilarating qualities of the coffee reside.

This work had also the following to say on the clearing of coffee, which was then a much-mooted question:

The clearing of coffee is a circumstance demanding particular attention. After the heaviest parts of the grounds have settled, there are still fine particles suspended for some time, and if the coffee be poured off before these have subsided, the liquor is deficient in that transparency which is one test of its perfection; for coffee not well cleared has always an unpleasant bitter taste. In general, the coffee becomes clear by simply remaining quiet for a few minutes, as we have stated; but those who are anxious to have it as clear as possible employ some artificial means of assisting the clearing. The addition of a little isinglass, hartshorn shavings, skins of eels or soles, white of eggs, egg shells, etc., has been recommended for clear-

ing; but it is evident that these substances, to produce their effect, which is upon the same principle as the fining of beer or wine, should be dissolved previously, for if put in without, it would require so much time to dissolve, that the flavour of the coffee would vanish.

Coffee-making devices of this period in England, in addition to the Rumford type of percolator and the popular coffee biggin, included Evans' machine provided with a tin air-float to which was attached a filter bag containing the coffee; Jones' apparatus, a pumping percolator; Parker's steam-fountain coffee maker, which forced the hot water upward through the ground coffee; Platow's patent filter, previously mentioned, a single vacuum glass percolator in combination with an urn; Brain's vacuum or pneumatic filter employing a "muslin, linen or shamoy leather filter" and an exhausting pump, designed for kitchen use; and Palmer's and Beart's pneumatic filtering machines of similar construction.

Cold infusions were common, the practice being to let them stand overnight, to be filtered in the morning, and only heated, not boiled.

Coffee grinding for these various types of coffee makers was performed by iron mills; the portable box mill being most favored for family use. "It consisted of a square box either of mahogany or iron japanned, containing in the interior a hollow cone of steel with sharp grooves on the inside; into this fits a conical piece of hardened iron or steel having spiral grooves cut upon its surface and capable of being turned round by a handle." There was a drawer to receive the finely ground coffee. Larger wall-mills employed the same grinding mechanism.

In 1855, Dr. John Doran wrote in his *Table Traits*:

With regard to the making of coffee, there is no doubt that the Turkish method of pounding the coffee in a mortar is infinitely superior to grinding it in a mill, as with us. But after either method the process recommended by M. Soyer may be advantageously adopted: namely, "Put two ounces of ground coffee into a stewpan, which set upon the fire, stirring the coffee round with a spoon until quite hot, then pour over a pint of boiling water; cover over closely for five minutes, pass it through a cloth, warm again, and serve."

From observations by G. W. Poore, M.D., London, 1883, we are given a glimpse of coffee making in England in the latter part of the nineteenth century. He said:

Those who wish to enjoy really good coffee must have it fresh roasted. On the Continent, in every well-regulated household, the daily supply of coffee is roasted every morning. In England this is rarely done.

If roasted coffee has to be kept, it must be kept in an air-tight vessel. In France, coffee used to be kept in a wrapper of waxed leather, which was always closely tied over the contained coffee. In this way the coffee was kept from contact with any air.

The Viennese say that coffee should be kept in a glass bottle closed with a bung, and that coffee should on no account be kept in a tin canister.

The coffee having been roasted, it has to be reduced to a coarse powder before the infusion is made. The grinding and powdering of coffee should be done just before it is wanted, for if the whole coffee seeds quickly lose their aroma, how much more quickly will the aroma be dissipated from coffee which has been reduced to a fine powder? Nothing need be said in the matter of coffee mills. They are common

enough, varied enough, and cheap enough to suit all tastes.

To insure a really good cup of coffee attention must be given to the following points:

1. Be sure that the coffee is good in quality, freshly roasted, and fresh ground.

2. Use sufficient coffee. I have made some experiments on this point, and I have come to the conclusions that one ounce of coffee to a pint of water makes poor coffee, 1½ ounces of coffee to a pint of water makes fairly good coffee, two ounces of coffee to a pint of water makes excellent coffee.

3. As to the form of coffee pot I have nothing to say. The varieties of coffee machines are very numerous and many of them are useless incumbrances. At the best, they can not be regarded as absolutely necessary. The Brazilians insist that coffee pots should on no account be made of metal, but that porcelain or earthenware is alone permissible. I have been in the habit of late of having my coffee made in a common jug provided with a strainer, and I believe there is nothing better.

4. Warm the jug, put the coffee into it, boil the water, and pour the boiling water on the coffee, and the thing is done.

5. Coffee must not be boiled, or at most it must be allowed just to "come to a boil," as cook says. If violent ebullition takes place, the aroma of the coffee is dissipated, and the beverage is spoiled.

The most economical way of making coffee is to put the coffee into a jug and pour cold water upon it. This should be done some hours before the coffee is wanted—over night, for instance, if the coffee be required for breakfast. The light particles of coffee will imbibe the water and fall to the bottom of the jug in course of time. When the coffee is to be used stand the jug in a saucepan of water or a bainmarie and place the outer vessel over the fire till the water contained in it boils. The coffee in this way is gently brought to the boiling point without violent ebullition, and we get the maximum extract without any loss of aroma.



BELGIAN, RUSSIAN, AND FRENCH PEWTER SERVING POTS

These are in the Metropolitan Museum of Art, New York, and are of nineteenth century design.



GROUP OF EUROPEAN AND ASIATIC COFFEE MAKERS

1. Belgium—Silver plated or nickel. 2. China—metal pot, aluminum or brass nickel. 3. Turkey—brass antique, used throughout Mediterranean countries. 4. Persia—brass, long spout. 5. Germany—china drip pot in two parts. 6. England—willow pattern, china pot. 7. France—small china drip pot. 8. Sweden—brewing jar with filter cloth. 9. France—silver, one-cup style, fits on top of a coffee cup.

Always make your coffee strong. *Café au lait* is much better if made with one-fourth strong coffee and three-fourths milk than if made half-and-half with a weaker coffee; this is evident.

It is a mistake to suppose that coffee can not be made without a great deal of costly and cumbersome apparatus.

**THE CONTINENT.** Rossignon has given us a general view of coffee making on the continent of Europe in the middle of the nineteenth century. He says:

Formerly, small bags of baize were used to percolate coffee. The water was poured on the coffee, and when they were new the coffee percolated through them was pretty good, but when they had been used a few times they became greasy and it was very difficult to clean them by any means. The greasy baize altered the quality of the coffee, and in spite of all efforts to keep it clean the coffee had a tarnished appearance very disagreeable to the view. Very few persons use them at present. The apparatus most in use for the percolation of coffee is a tin coffee-pot composed of two parts. The upper one has a filter or sieve on which the coffee powder is placed and through which the filtered coffee must pass. Boiling water is poured on the coffee. The liquor which percolates falls in the second part. Then the upper part is removed

and the coffee is ready as a beverage. There are very many systems of coffee pots. One of the best is the Russian one, which consists of a receptacle composed of two parts resembling two halves of an egg screwed together. One part contains the hot water and the other the ground coffee. In the center there is a filter. Turning the pot upside down the percolation takes place very slowly and no aroma is lost.

The tin plate which is generally used to make the coffee pot has many drawbacks. One of them is the dissolution of iron which takes place after it has been used for a short time.

The quality of coffee, as a beverage, depends principally on the degree of heat of the water. Experience has shown that a medium class of coffee prepared at a moderate heat gives a very good liquor, while excellent coffee on which boiling water has been poured did not give a very good liquor. Therefore, instead of pouring boiling water at 100°C. in a porcelain or silver coffee-pot, those who desire to make a perfect coffee must use water heated from 60° to 75°C.

**FRANCE.** Also about the middle of the nineteenth century the French naturalist, Du Tour, thus describes one manner of making coffee in France:

Let the powder be poured into the coffee-pot filled with boiling water, in the proportion of



two ounces and a half to two pounds, or two English pints of water. Let the mixture be stirred with a spoon, and the coffee-pot be soon taken off the fire, but suffered to remain closely shut, for about at least two hours, on the warm ashes of a wood fire. During the infusion the liquor should be several times agitated by a chocolate frother, or something similar, and left for about fifteen minutes to settle.

*Café au lait* was first made as *café noir*, only stronger; then as much of this coffee as was required was poured in the cup, and the cup was filled up with *boiled* milk. *Café a la crème* was made by adding boiled cream to strong clear coffee and heating them together.

In France, during the latter part of the nineteenth century, coffee was roasted over charcoal fires in earthenware dishes or saucepans, stirred with a spatula or wooden spoon, or in small cylinder or globular roasters of iron. Gas roasting was also practised. When roasted in large batches, the beans were cooled in wicker baskets, tossed into the air. The grinding was preferably done in mortars or in box mills of pyramid shape with receiving drawers, and was not too fine.

The usual method of making coffee in France among the better classes at this time was by means of improved De Belloy drip devices, double glass vacuum filters, pumping percolators (double circulation devices), the Russian egg-shaped pots, and the Viennese machines. The last-named were metal pumping percolators with glass tops, usually swung between the uprights of a carry arrangement, the base of which held a spirit lamp.

Among the numerous French machines which became well known were: Reparlier's glass "filter"; Egrot's steam cloth-filter machine and Malen's percolator apparatus, both designed for barracks and ships, where previously the coffee had been brewed in soup kettles; Bouillon Muller's steam percolator; Laurent's whistling coffee pot, a steam percolator which announced when the coffee was ready; Ed Loysel's rapid filter, a hydrostatic percolator; and those pots to which Morize, Lemare, Grandin, Crepaux, and Gandais gave their names.

In 1892, the French minister of war directed that in the army roasting and grinding operations the coffee chaff should no longer be thrown away, as it had been



POPULAR GERMAN DRIP POT

found that it was rich in caffeine and aroma constituents.

Coffee *à la minute*, which appeared in France in the nineteenth century, was made by decoction or infusion through a funnel pierced with holes and covered inside with blotting paper, or a woolen strainer cloth. This system, says Jardin, suggested the economical coffee pot.

A popular German drip coffee maker of the late nineteenth century employs a plug in the spout which provides air pressure to hold back the infusion until the plug is removed.

Pierre Joseph Buc'hoz, physician to the king of Poland, in 1787, made a business of supplying roasted coffee in small packets, each sufficient for one cup. He built up quite a trade until one day he was caught substituting roasted rye for coffee. This was the Buc'hoz method of making coffee, much practised by the lower classes because he was looked upon as an authority:

Boil the water in a coffee pot. When it boils, draw it from the fire long enough to add an ounce of coffee powder to a pound of water. Stir with a spoon. Return it to the fire and when it boils move it back somewhat from the heat and let it simmer for eight minutes. Clarify with sugar or deer horn powder.

#### *Early Coffee Making in the United States*

The coffee drink reached the colonies, first as a beverage for the well-to-do, about 1668. When introduced to the general public through the coffee houses about 1700, it was first sipped from small dishes as in

England; and no one inquired too closely as to how it was made. When, half a century later, it had displaced beer and tea for breakfast, its correct making became a matter of polite inquiry. It was not until well into the nineteenth century that there was any suggestion of scientific interest, and not until within the last decade or two was any real chemical analysis of brewed coffee undertaken with a view to producing a scientific cup of the beverage.

At first, owing to the great distances, and difficulties surrounding communications, between the colonies, news of improvements in coffee makers and coffee making traveled slowly, and coffee customs brought from Europe by the early settlers became habits that were not easily changed. Some of the worst have clung on, ignoring the march of improvement, and seem as firmly entrenched in suburban and rural communities today as they were two hundred years ago.

Indeed, despite the fact that the United States has been the largest consumer of coffee among the nations for half a century, it is only with the last 25 years that coffee properly prepared could be obtained outside the principal cities. Even today, the average consumer is sadly in need of education in correct coffee brewing. It would be an excellent idea if all the coffee propaganda funds could be concentrated on a study of this one phase of the coffee question for several years, and the recommendations published in such fashion as firmly to fix in the minds of the rising generation a knowledge of correct coffee brewing. The facts of the case are that, generally speaking, coffee is still prepared in slovenly fashion in the average American home. However, with the good work done in recent years by organized trade effort to correct this abuse of our national beverage, signs are plentiful that the time is not far distant when a lasting reformation in coffee making will have been accomplished.

In colonial times the coffee drink was mostly a decoction. Esther Singleton tells us that in New Amsterdam coffee was boiled in a copper pot lined with tin and drunk as hot as possible with sugar or honey and spices. "Sometimes a pint of fresh milk was brought to the boiling point and then as much drawn tincture of coffee was added, or the coffee was put in cold water with the milk and both were boiled

together and drunk. Rich people mixed cloves, cinnamon, or sugar with ambergris in the coffee."<sup>5</sup>

Ground cardamom seeds were also used to flavor the decoction.

In the early days of New England, the whole beans were frequently boiled for hours with not wholly pleasing results in forming either food or drink.<sup>6</sup>

In New Orleans, the ground coffee was put into a tin or pewter coffee dripper, and the infusion was made by slowly pouring the boiling water over it after the French fashion. The coffee was not considered good unless it actually stained the cup. This method still obtains among the old Creole families.

Boiling coarsely pounded coffee for fifteen minutes to half an hour was common practice in the colonies before 1800.

In the early part of the nineteenth century, the best practice was to roast the coffee in an iron cylinder that stood before the hearth fire. It was either turned by a handle or wound up like a jack to go by itself. The grinding was done in a lap or wall mill; and among the best known makes were Kenrick's, Wilson's, Wolf's, John Luther's, George W. M. Vandergrift's, and Charles Parker's "Best Quality."

To make coffee "without boiling" the cookery books of the period advised the housewife to obtain "a biggin, the best of which is what in France is called a Grecque."

In 1844, the *Kitchen Directory and American Housewife's* advice on the subject of coffee making was as follows:

Coffee should be put in an iron pot and dried near a moderate fire for several hours before roasting (in pot over hot coals and stirring constantly). It is sufficiently roasted when biting one of the lightest colored kernels—if brittle the whole is done. A coffee roaster is better than an open pot. Use a tablespoonful ground to a pint of boiling water. Boil in tin pot twenty to twenty-five minutes. If boiled longer it will not taste fresh and lively. Let stand four or five minutes to settle, pour off grounds into a coffee pot or urn. Put fish skin or isinglass size of a nine pence in pot when put on to boil or else the white and shell of half an egg to a couple of quarts of coffee. French coffee is made in a German filter, the water is turned on boiling hot and one-third more coffee is needed than when boiled in the common way.

<sup>5</sup> *Dutch New York*, 1909 (p. 132).

<sup>6</sup> Earle, Alice Morse. *Customs' and Fashions in Old New England*, 1909.

In 1856, the *Ladies' Home Magazine*—(now the *Ladies' Home Journal*)—printed the following, which fairly sums up the coffee making customs of that period:

Coffee, if you would have its best flavor, should be roasted at home; but *not in an open pan*, for this permits a large amount of aroma to escape. The roaster should be a closed sphere or cylinder. The aroma, upon which the good taste of the coffee depends, is only developed in the berry by the roasting process, which also is necessary to diminish its toughness, and fit it for grinding. While roasting, coffee loses from fifteen to twenty-five per cent of its weight, and gains from thirty to fifty per cent in bulk. More depends upon the proper roasting than upon the quality of the coffee itself. One or two scorched or burned berries will materially injure the flavor of several cupfuls. Even a slight overheating diminishes the good taste.

The best mode of roasting, where it is done at home, is to dry the coffee first, in an open vessel, until its color is slightly changed. This allows the moisture to escape. Then cover it closely and scorch it, keeping up a constant agitation, so that no portion of a kernel may be unequally heated. Too low and too slow a heat dries it up without producing the full aromatic flavor; while too great heat dissipates the oily matter and leaves only bitter charred kernels. It should be heated so as to acquire a uniform deep cinnamon color, and an oily appearance, but never a deep, dark brown color. It then should be taken from the fire and kept closely covered until cold, and further until used. While unroasted coffee improves by age, the roasted berries will very generally lose their aroma if not covered very closely. The ground stuff kept on sale in barrels, or boxes, or in papers, is not worthy the name of coffee.

Coffee should not be ground until just before using. If ground over night, it should be covered; or, what is quite as well, put into the boiler and covered with water. The water not only retains the valuable oil and other aromatic elements, but also prepares it by soaking for immediate boiling in the morning.

If the coffee pot (the "*Old Dominion*," of course, for in a common boiler this process would ruin the coffee by wasting the aroma) be set on the range or stove, or near the fire, so as to be kept hot all night preparatory to boiling in the morning, the beverage will be found in the morning, rich, mellow, and of a most delicious flavor.

Coffee used at supper time should be placed on or near the fire immediately after dinner and kept hot or simmering—not boiling—all the afternoon.

Try this method if you wish coffee in perfection.

Wood's improved coffee roaster is acknowledged to be the best article of the kind now in use.

This patent coffee roaster has been improved by the introduction of a triangular flange inside of each of the hemispheres, as seen in the cut. These flanges, as the roaster is turned, catch the coffee and throw it from the inner surface, thus insuring a perfect uniformity in the burning.

The Woods roaster (1849) and the Old Dominion Coffee Pot (1856) have been referred to in chapter XXXV

From the *Encyclopedia of Practical Cookery*, we learn more about the customs prevailing "among the first cooks in the country" in roasting and making coffee in the United States about the middle of the nineteenth century. For example:

#### ROASTING COFFEE BEANS

Put the beans in the roaster, set this before a moderate fire, and turn slowly until the Coffee takes a good brown colour; for this it should require about twenty-five minutes. Open the cover to see when it is done. If browned, transfer it to an earthen jar, cover it tightly, and use when needed.

Or a more simple plan, and even more effectual, is to take a tin baking-dish, butter well the bottom, put the Coffee in it, and set it in a moderate oven until the beans take a strong golden colour, twenty minutes sufficing for this. Toss them frequently with a wooden spoon.

Another plan is to put in a small frying-pan 1 lb. of raw Coffee-beans and set the pan on the fire, stirring and shaking occasionally till the beans are yellow; then cover the frying-pan and shake the Coffee about till it is a dark brown. Move the pan off the fire, keep the cover on, and when the beans are a little cool, break an egg over them and stir them until they are all well coated with the egg. Then store the Coffee in tins or jars with tight-fitting lids, and grind it as wanted for use.

Coffee should always be bought in the bean and ground as required, otherwise it is liable to extensive adulteration with chicory (or succory); some persons like the addition, but the epicure who is really fond of Coffee would not admit of its introduction.

#### MAKING BREAKFAST COFFEE

Allow 1 tablespoonful of Coffee to each person. The Coffee when ground should be measured, put into the Coffee-pot, and boiling water poured over it in the proportion of  $\frac{3}{4}$  pint to each tablespoonful of Coffee, and the pot put on the fire; the instant it boils, take the pot off, uncover it, and let it stand a minute or two; then cover it again, put it back on the fire, and let it boil up again. Take it from the fire and let it stand for five minutes to settle. It is then ready to pour out.

This work recommended as among the latest and best devices for coffee making, all those manufactured or sold in this country by Adams & Son; the English coffee biggin; General Hutchinson's coffee pot and urn, combining De Belloy's and Rumford's ideas; Le Brun's "Cafetière" for making coffee by distillation and by steam pressure, passing it directly into the cup; a Vienna coffee-making machine, and a Russian coffee reversible pot called the "Potsdam" (see illustrations, page 630).

Among two score of coffee recipes for making various kinds of extracts, ices, candies, cakes, etc., flavored with coffee, there is a curious one for coffee beer, the invention of a Frenchman named Pluehart.

The ingredients and quantities in a thousand parts are—Strong coffee 300; rum 300; syrup thickened with gum senegal 65; alcoholic extract of orange peel 10; and water 325.

“It does not appear to have reached any important degree of popularity,” adds the editor.

In 1861, Godey's *Lady's Book and Magazine* noted with approval the growing custom of hotel and restaurant guests to order coffee instead of wines or spirits with their dinners. On the subject of “How to make a cup of coffee” it had this to say:

Which is the best way of making coffee? In this particular notions differ. For example, the Turks do not trouble themselves to take off the bitterness by sugar, nor do they seek to disguise the flavor by milk, as is our custom. But they add to each dish a drop of the essence of amber, or put a couple of cloves in it, during the process of preparation. Such flavoring would not, we opine, agree with western tastes. If a cup of the very best coffee, prepared in the highest perfection and boiling hot, be placed on a table in the middle of a room and suffered to cool, it will, in cooling, fill the room with its fragrance; but becoming cold, it will lose much of its flavor. Being again heated, its taste and flavor will be still further impaired, and heated a third time, it will be found vapid and nauseous. The aroma diffused through the room proved that the coffee has been deprived of its most volatile parts, and hence of its agreeableness and virtue. By pouring boiling water on the coffee, and surrounding the containing vessel with boiling water, the finer qualities of the coffee will be preserved.

Boiling coffee in a coffee-pot is neither economical or judicious, so much of the aroma being wasted by this method. Count Rumford (no mean authority) states that one pound of good Mocha, when roasted and ground, will make fifty-six cups of the very best coffee, but it must be ground finely, or the surfaces of the particles only will be acted upon by the hot water, and much of the essence will be left in the grounds.

In the East, coffee is said to arouse, exhilarate, and keep awake, allaying hunger, and giving to the weary renewed strength and vigor, while it imparts a feeling of comfort and repose. The Arabians, when they take their coffee off the fire, wrap the vessel in a wet cloth, which fines the liquor instantly, and makes it cream at the top. There is one great essential to be observed, namely, that coffee should not be ground before it is required for use, as in a powdered state its finer qualities evaporate.

We pass over the usual modes of making coffee, as being familiar to every lady who presides over every household; and content ourselves with the most modern and approved Parisian methods, though we may add that a

common recipe for good coffee is—two ounces of coffee and one quart of water. Filter or boil ten minutes, and leave to clear ten minutes.

The French make an extremely strong coffee. For breakfast, they drink one-third of the infusion, and two-thirds of hot milk. The *café noir* used after dinner, is the very essence of the berry. Only a small cup is taken, sweetened with white sugar or sugar-candy, and sometimes a little *eau de vie* is poured over the sugar in a spoon held above the surface, and set on fire; or after it, a very small glass of *liqueur*, called a *chasse-café*, is immediately drunk. But the best method, prevalent in France, for making coffee (and the infusion may be strong or otherwise as taste may direct) is to take a large coffee-pot with an upper receptacle made to fit close into it, the bottom of which is perforated with small holes, containing in its interior two movable metal strainers, over the second of which the powder is to be placed, and immediately under the third. Upon this upper strainer pour boiling water, and continue to do so gently; until it bubbles up through the strainer; then shut the cover of the machine close down, place it near the fire, and so soon as the water has drained through the coffee, repeat the operation until the whole intended quantity be passed. No finings are required. Thus all the fragrance of its perfume will be retained with all the balsamic and stimulating powers of its essence. This is a true Parisian mode, and *voilà!* a cup of excellent coffee.

This article is most interesting in that it shows the revolt against boiling coffee had started in the United States; also that the importance of fine grinding was being recognized and emphasized by the leaders of the best thought of the nation.

Probably the first scientific inquiry into the subject of coffee roasting and brewing in the United States was that detailed by August T. Dawson and Charles M. Wetherill, Ph.D., M.D., in the *Journal of the Franklin Institute* for July and August, 1855. The following is a digest:

There are two classes of beverages: 1, alcoholic, and 2, nitrogenized. Nitrogenized foods are effective to replace the substance of the different organs of the body wasted away by the process of vitality. Coffee is one of these.

Besides the tannin, the coffee berry contains two substances, one the nitrogenized quality, caffeine, which is about one per cent and is not altered in roasting, and the other a volatile oil which is developed in roasting and which gives the coffee its flavor. Dr. Julius Lehman (*Liebig's Annales* LXXXVII, 205) says that coffee retards the waste tissues of the body and diminishes the amount of food necessary to preserve life. This effect is due to the oil. Much of the nutritive portion of coffee is lost by European methods of making.

Good coffee is very rare. These experiments were made to ascertain whether a potable coffee could not be offered to the public at as low a price as the raw or roasted now is. In order to be successful we needed to extract a

larger portion of the nutritive substances than is extracted in the household. The experiments have proved vain.

As a result of our experiments with different ways of roasting and brewing coffee, we have found the following plan to be the most convenient and the best: the coffee will taste the same every time and it will taste good. If a good berry be properly roasted and the infusion be of the proper strength, good coffee must result. A Mocha berry should be selected and roasted seven or eight pounds at a time in a cylindrical drum. After roasting it should be placed in a stone jar with a mouth three inches in diameter. The jar should be closed air-tight. This will furnish two cups of coffee daily for six months. A quart should be taken from the jar at a time and ground. The ground coffee should be kept in covered glass jars.

The best coffee pot was found to be the common biggin having an upper compartment with a perforated bottom upon which to place the coffee. To make one cup of this infusion, place half an ounce of ground coffee in the upper compartment and six fluid ounces of water into the bottom. Put the biggin over a gas lamp. After three minutes the water will boil. When steam appears, take the biggin from the fire and pour the water into a cup and thence immediately into the top of the biggin where it will extract the berry by replacement. (Here follows an experiment.)

This experiment shows that loss of weight is no criterion that coffee is properly roasted, neither is the color (by itself) nor the temperature, nor the time.

Next we experimented to ascertain whether the aroma developed by roasting coffee and which is lost might not be collected and added to the coffee at pleasure. An attempt was made to drive the volatile oils from roasted coffee by steam and make a dried extract of the residual coffee to which the oils were to be later added. Two attempts were made and both failed. It appears that but a small quantity of the aroma is lost in roasting and that is mixed with bad smelling vapors from which it is impossible to free it.

Then we tried to make a potable coffee by making an aqueous extract of raw coffee, evaporating to dryness and roasting the residue. (Here follows the experiment.)

This also was unsuccessful. The great trouble here is a dark shiny residue, which, while tasteless, is very disagreeable to look at. In the preparation of coffee by boiling, two and a half times as much matter is extracted as by biggin.

The proper method of roasting coffee is as follows: It should be placed in a cylinder and turned constantly over a bright fire. When white smoke begins to appear, the contents should be closely watched. Keep testing the grains. As soon as a grain breaks easily at a slight blow, at which time the color will be a light chestnut brown, the coffee is done. Cool it by lifting some up and dropping it back with a tin cup. If it be left to cool in a heap there is great danger of over-roasting. Keep the coffee only in air-tight vessels. Measure the infusions, a half ounce of coffee to six ounces of water per cup.

All "extracts of coffee" are worthless. Most

of them are composed of burned sugar, chicory, carrots, etc.

In 1883, an authority of that day, Francis B. Thurber, in his book, *Coffee; from Plantation to Cup*, which he dedicated to the railroad restaurant man at Poughkeepsie, because he served an "ideal cup of coffee," favored the good old boiling method with eggs. This was the Thurber recipe:

Grind moderately fine a large cup or small bowl of coffee; break into it one egg with shell; mix well, adding enough cold water to thoroughly wet the grounds; upon this pour one pint of boiling water: let it boil slowly for ten to fifteen minutes, according to the variety of coffee used and the fineness to which it is ground. Let it stand three minutes to settle, then pour through a fine wire-sieve into a warm coffee pot; this will make enough for four persons. At table, first put the sugar into the cup, then fill half-full of boiling milk, add your coffee, and you have a delicious beverage that will be a revelation to many poor mortals who have an indistinct remembrance of, and an intense longing for, an ideal cup of coffee. If cream can be procured so much the better, and in that case boiling water can be added either in the pot or cup to make up for the space occupied by the milk as above; or condensed milk will be found a good substitute for cream.

In 1886, however, Jabez Burns, who knew something about the practical making of the beverage as well as the roasting and grinding operations, said:

Have boiling water handy. Take a clean dry pot and put in the ground coffee. Place on fire to warm pot and coffee. Pour on sufficient boiling water, not more than two-thirds full. As soon as the water boils add a little cold water and remove from fire. To extract the greatest virtue of coffee, grind it fine and pour scalding water over it.

John Cotton Dana, of the Newark Public Library, tells how in his old home in Woodstock, Vt., they had always, in the attic, a big stone jar of green coffee. This was sacred to the great feast days, Thanksgiving, Christmas, etc. Just before those anniversaries, the jar was brought forward and the proper amount of coffee was taken out and roasted in a flat sheet-iron pan on the top of the stove, being stirred constantly and watched with great care. "As my memory seems to say that this was not constantly done," says Mr. Dana, "it would seem that, even then, my father, who kept the general store in the village, bought roasted coffee in Boston or New York."

At the close of the century, there were still many advocates of boiling coffee; but



although the coffee trade was not quite ready to declare its absolute independence in this direction, there were many leaders who boldly proclaimed their freedom from the old prejudice. Arthur Gray, in his *Over the Black Coffee*, as late as 1902, quoted "the largest coffee importing house in the United States" as advocating the use of eggs and egg-shells and boiling the mixture for ten minutes.

#### *Developments in Better Coffee Making*

Better coffee making by co-operative trade effort got its initial stimulus at the 1912 convention of the National Coffee Roasters Association. As a result of discussions at that meeting and thereafter, a Better Coffee Making Committee was created for investigation and research.

The coffee trade's declaration of independence in the matter of boiled coffee was made at the 1913 convention of the National Coffee Roasters Association, when, after hearing the report of the Better Coffee Making Committee, presented by the late Edward Aborn of New York, it adopted a resolution saying that the recommendations met with its approval and ordering that they be printed and circulated.

The work done by the committee included "the first chemical analysis of brewed coffee on record," a study of grindings, and a comparison of the results of four brewing methods. Its conclusions and recommendations were embodied in a booklet published by the National Coffee Roasters Association, entitled *From Tree to Cup with Coffee*.

The committee made a further report in 1914, and some of the findings were subsequently published in an association booklet called *The Coffee Book*, used in connection with the second National Coffee Week campaign in 1915.

Also, the committee emphasized its previous findings, particularly this one: "Filter bags should be kept in cold water when not in use. Drying causes decomposition. Keeps sweet if kept wet. Use muslin for filter bag and pulverized granulation."

At the suggestion of the author, the efficiency of nine different coffee-making devices (including boiling and drip pots, pumping percolators, cloth and paper filters) was investigated in the laboratories of the Mellon Institute of Industrial Re-

search of the University of Pittsburgh in 1915; and Dr. Raymond F. Bacon submitted a report that showed that the boiling method produced the highest percentage of caffetannic acid and caffeine; the French drip process the lowest. The investigation disclosed also a more palatable brew at 195° to 200° F. than at the boiling point.

Another notable contribution to the science of coffee brewing was made by the Home Economics Laboratories of the University of Kansas in 1916. The experiments extended over one year. They showed that strength and color in coffee brews are independent of blend and price and are most fully obtained by pulverized granulation, which was found to be the most efficient; that the consumer pays for flavor and that filtration yielded the best brew. The French drip, or true percolator, did not figure in these experiments.

At the 1915 convention of the National Coffee Roasters Association, Mr. Aborn reported that 4,000 copies of the committee's findings on grinding and brewing had been given away; and the facts were further circulated in 2,000,000 booklets issued during two years. He told of tests which showed that while there might be reasons of commercial expediency for packing ground coffee, it could not be defended as a quality principle; also that plate-grinders produced a more efficient drawing granulation than roller grinders, and that the idea that the steel-cut process eliminates dirt was an absurdity, as "the finest ground coffee is not dirt but coffee in its most efficient drawing condition." He added, "I have paid no attention to chaff removal in these tests as the uselessness of such removal has been repeatedly shown up." The reference here was to his 1914 and 1913 reports, in which it was stated that "removing the chaff in the steel-cut process does not remove any of the tannin, and for this purpose the steel-cut process is wholly futile, and a wasteful and unnecessary tax upon cost," and that "the removal of the chaff appreciably affects the flavor and depreciates the cup value."

This report repeated previous findings against the pumping percolator as producing an inefficient brew and being a very faulty utensil. Mr. Aborn concluded his report by saying:

The old time boiling method has fewer and fewer defenders and holds its own only as a superstition. I therefore pass it over as a dis-

carded issue . . . It is but repetition of former reports for me to say that pulverized granulation is the most efficient granulation; that it assures the highest quality of brew and the lowest proportion of coffee to a given strength; that it is the most saving and most satisfying grinding for all to use; that it (the coffee) must be fresh ground; that the filtration method is the most correct in fundamental principles and that used with a muslin bag it assures the consumer coffee of the purest, finest flavored quality, highest health value and sure economy.

The campaign of education was continued during 1916, producing encouraging results among schools, colleges, the medical fraternity, newspapers, with the trade and the consumer. It marked the first big constructive work combining the practical and scientific phases of grinding and brewing methods.

The Better Coffee Making Committee published in 1917 a booklet entitled *Coffee Grinding and Brewing* in which it summarized its work to date, and presented its special plea for cotton-cloth filters as the ideal coffee-making device.

This device aroused considerable discussion, particularly between those who favored the paper filter and those who, with Mr. Aborn, believed cotton cloth, such as muslin, to be the most efficient strainer. "Cotton," argued Mr. Aborn, "is an ideal sanitary strainer because it contains no chemical or questionable manufacturing element."

On the other hand, it was pointed out by Dr. Floyd W. Robison, of the Detroit Testing Laboratories, that while cotton cloth, such as muslin, does give a fairly clear coffee, it is not so clear as by the methods where a filter paper is used. He said:

Both methods have serious objectionable features. The muslin bag, particularly, is decidedly unsanitary, especially when used in restaurants and hotels. It is rarely kept clean, and one who has frequented restaurants and many hotel kitchens knows that it lends itself to very unclean and unsightly methods of handling. The food inspector has to check this up perhaps as often as any one feature about a restaurant.

The objection to the filter paper is not at all on the ground of sanitation. It is ideal in this respect. The claim is made, and at least, in part, substantiated, that it does hold back valuable features of the brew.

There are many points about the filter that have not been considered at all. Mr. Calkin believes that the very best type of filter is a bed of coffee itself, and I must say this has the sanction of good laboratory experience.

I. D. Richheimer, attacking the cotton cloth filter, said:

It is a known fact that the fats in coffee are very dense and represent twelve to fifteen percent of the coffee weight. These fats—due to the simplest chemical action of contact with air, moisture and continued heat—begin a fermentation in the completed beverage. In the cloth-filtering process—due to the rapid passage of water through grounds almost as quickly as poured—the largest percentage of fats is carried into the beverage. Fat being lighter than water rises to the top of water if given a certain amount of time during the brewing process. Were there no fats (which ferment) in coffee there would be no need for placing cloth-filtering material under water, as suggested, to keep them from becoming sour.<sup>1</sup>

In the booklet referred to, Mr. Aborn expressed himself as follows on the filtration method:

The filtration method is not new, but well tried, thoroughly proven and long used, though often incorrectly. It is the method followed, more or less correctly, by all of the first-class hotels in the world. It is controlled by no patent or proprietary device, and requires a most inexpensive equipment. For a perfect result it but demands an accurate adherence to simple but vital principles. Deviations from these fundamentals, though apparently slight, cause failure. When they, and the necessary *exact* following of them, are clearly understood, any person, even a small child, can brew coffee with unvarying success.

The first point to consider in filtration is the dimensions of the filter bag, or container of the ground coffee, in relation to the quantity of coffee used and the granulation of same. If the filter be a muslin bag, free on all sides, the filtering surface is considerable and permits the necessary quick passage of water through the grounds, provided the bag is of a wide enough diameter as to prevent too great a depth of grounds through which the water cannot quickly penetrate. The error of too narrow a filter is a common one. It causes a delayed filtration, which means undesirably long contact of water and coffee and also the cooling of the liquid which in a correct, undelayed filtration is smoking hot at completion. The bag should also not be too long or be allowed to hang or soak in the liquid. A filter bag set tightly into a pot against its sides, thus surrounded with impenetrable walls, is greatly reduced in filtering surface, and the filtration is thereby slackened.

The filter material should not be too coarse in texture, like cheese cloth, or too heavy and impenetrable, like very heavy muslin. A moderate weight muslin, not too light, is efficient.

The degree of granulation also, of course, affects the rate of flow. The coarser the grind the faster the flow, which permits a larger quantity of coffee to a given diameter of filter bag.

<sup>1</sup> *Tea and Coffee Trade Jour.*, 1917 (vol. xxxiii: no. 5: pp. 339-40).

A most frequent fault in the use of the filtration method is the failure to understand the fine degree of grinding necessary to the best results. When the grind is not sufficiently fine the extraction is, of course, weak. A fine grind (like fine cornmeal) is essential. It does not retard the flow if the filter is of right dimensions. A powdered grind (like flour) is so fine that it is apt to "mat" itself into a resisting floor.

Many users of the filtration method pour the liquid through more than once. This gains some added color, but adds undesirable elements, depreciates flavor, and is especially inadvisable when the grind is sufficiently fine. *One pouring* only is recommended for the best results.

The chinaware, or glazed earthenware pot, sometimes called the French drip pot, with a chinaware or earthenware sieve container for the grounds at the top through which the water is poured, being free of all metal, is inviting in purity and in hygienic merit. Together with the filter bag, it is subject to the above remarks on dimensions. A chinaware sieve cannot be made as fine as a metal sieve and cannot of course hold very fine granulation as can cotton cloth. More coffee for a given strength is, therefore, required. The upper container should be wide enough, for a given quantity of coffee, as to allow an unretarded flow, and the more openings the strainer contains the better.

In any drip, filtration or percolating method the stirring of the grounds causes an over-contact of water and coffee and results in an over-drawn liquor of injured flavor. If the water does not pass through the grounds readily, the fault is as above indicated and cannot be corrected by stirring or agitation. Many complaints of bitter taste are traced to this error in the use of the filtration method.

It is not necessary to pour on the water in driblets. The water may be poured slowly, but the grounds should be kept well covered. The weight of the water helps the flow downward through the grounds. Care should be taken to keep up the temperature of the water. Set the kettle back on the stove when not pouring. If the water is measured, use a small heated vessel, which fill and empty quickly without allowing the water to cool.

In 1917, *The Tea and Coffee Trade Journal* made a comparative coffee-brewing test with a regulation coffee pot for boiling, a pumping percolator, a double glass filtration device, a cloth-filter device, and a paper filter device. The cup tests were made by E. M. Frankel, Ph.D.; and William B. Harris, coffee expert, United States Department of Agriculture. The brews were judged for color, flavor (palatability, smoothness), body (richness), and aroma. The test showed that the paper filtration device produced the most superior brew. The cloth-filter, glass-filter, percolator, and boiling pot followed in the order named.

At the 1917 convention of the National Coffee Roasters Association, John E. King,

of Detroit, announced that laboratory research which he had had conducted for him showed that the finer the grind, the greater the loss of aroma, and so he had selected a grind containing ninety per cent of very fine coffee and ten per cent of a coarser nature, which seemed to retain the aroma. He subsequently secured a United States patent for this grind. Mr. King announced also at this meeting that his investigations showed there was more than a strong likelihood that the much-discussed caffetannic acid did not exist in coffee—that it most probably was a mixture of chlorogenic and coffalic acids.

The World War operated to interfere with the coffee roasters' plans for a research bureau; and in the meantime the Brazil planters, in 1919, started a million-dollar advertising campaign in the United States, co-operating with a joint committee representing the green and roasted coffee interests. In the following year, this committee arranged with the Massachusetts Institute of Technology to start scientific research work on coffee, the literature of the roasters' Better Coffee Making Committee being turned over to it; and the Institute began to "test the results of the committee's work by purely analytical methods."

The first report on the research work at the Massachusetts Institute of Technology was made by Professor S. C. Prescott to the Joint Coffee Trade Publicity Committee in April, 1921. The committee gave out a statement saying that Prof. Prescott's report stated that "caffeine, the most characteristic principle of coffee, is, in the moderate quantities consumed by the average coffee drinker, a safe stimulant without harmful after-effects."

There was no publication of experimental results; but the announced findings were, in the main, a confirmation of the results of previous workers, particularly of Hollingworth, with whose statement, that "caffeine when taken with food in moderate amount is not in the least deleterious," the report was quoted as being in entire agreement.

At the annual convention of the National Coffee Roasters Association, November 2, 1921, Professor Prescott made a further report, in which he stated that investigations on coffee brewing had disclosed that coffee made with water between 185° and 200° was to be preferred to coffee made with the water at actual boiling temperature (212°), that the chemical action was

far less vigorous, and that the resulting infusion retained all the fine flavors and was freer from certain bitter or astringent flavors than that made at the higher temperature. Professor Prescott announced also that the best materials for coffee-making utensils were glass (including agate-ware, vitrified ware, porcelain, etc.), aluminum, nickel or silver plate, copper, and tin plate, in the order named.<sup>8</sup>

The Joint Coffee Trade Publicity Committee's booklet on *Coffee and Coffee Making*, issued in 1921, was guarded in its observations on grinding and brewing. It avoided all controversial points, but it did go so far as to say on the general subject of brewing:

Chemists have analyzed the coffee bean and told us that the only part of it which should go into our coffee cups for drinking is an aromatic oil. This aromatic element is extracted most efficiently only by fresh boiling water. The practice of soaking the grounds in cold water, therefore, is to be condemned. It is a mistake also to let the water and the grounds boil together after the real coffee flavor is once extracted. This extraction takes place very quickly, especially when the coffee is ground fine. The coarser the granulation the longer it is necessary to let the grounds remain in contact with the boiling water. Remember that flavor, the only flavor worth having, is extracted by the *short* contact of boiling water and coffee grounds, and that after this flavor is extracted, the coffee grounds become valueless dregs.

The report contained also the following helpful generalities on coffee service and the various methods of brewing in more or less common use in the United States:

Although the above rules are absolutely fundamental to good coffee making, their importance is so little appreciated that in some households the lifeless grounds from the breakfast coffee are left in the pot and resteepped for the next meal, with the addition of a small quantity of fresh coffee. Used coffee grounds are of no more value in coffee making than ashes are in kindling a fire.

After the coffee is brewed the true coffee flavor, now extracted from the bean, should be guarded carefully. When the brewed liquid is left on the fire or overheated this flavor is cooked away and the whole character of the beverage is changed. It is just as fatal to let the brew grow cold. If possible, coffee should be served as soon as it is made. If service is delayed, it should be kept hot but not overheated. For this purpose careful cooks prefer a double boiler over a slow fire. The cups should be warmed beforehand, and the same is true of a serving pot, if one is used. Brewed coffee,

once injured by cooling, cannot be restored by reheating.

Unsatisfactory results in coffee brewing frequently can be traced to a lack of care in keeping utensils clean. The fact that the coffee pot is used only for coffee making is no excuse for setting it away with a hasty rinse. Coffee making utensils should be cleansed after each using with scrupulous care. If a percolator is used pay special attention to the small tube through which the hot water rises to spray over the grounds. This should be scrubbed with the wire-handled brush that comes for the purpose.

In cleansing drip or filter bags use cool water. Hot water "cooks in" the coffee stains. After the bag is rinsed keep it submerged in cool water until time to use it again. Never let it dry. This treatment protects the cloth from the germs in the air which cause souring. New filter bags should be washed before using to remove the starch or sizing.

**DRIP (OR FILTER) COFFEE.** The principle behind this method is the quick contact of water at full boiling point with coffee ground as fine as it is practical to use it. The filtering medium may be of cloth or paper, or perforated china-ware or metal. The fineness of the grind should be regulated by the nature of the filtering medium, the grains being large enough not to slip through the perforations.

The amount of ground coffee to use may vary from a heaping teaspoonful to a rounded tablespoonful for each cup of coffee desired, depending upon the granulation, the kind of apparatus used and individual taste. A general rule is the finer the grind the smaller the amount of dry coffee required.

The most satisfactory grind for a cloth drip bag has the consistency of powdered sugar and shows a slight grit when rubbed between thumb and finger. Unbleached muslin makes the best bag for this granulation. For dripping coffee reduced to a powder, as fine as flour or confectioner's sugar, use a bag of canton flannel with the fuzzy side in. Powdered coffee, however, requires careful manipulation and cannot be recommended for everyday household use.

Put the ground coffee in the bag or sieve. Bring fresh water to a full boil and pour it through the coffee at a steady, gradual rate of flow. If a cloth drip bag is used, with a very finely ground coffee, one pouring should be enough. No special pot or device is necessary. The liquid coffee may be dripped into any handy vessel or directly into the cups. Dripping into the coffee cups, however, is not to be recommended unless the dripper is moved from cup to cup so that no one cup will get more than its share of the first flow, which is the strongest and best.

The brew is complete when it drips from the grounds, and further cooking or "heating up" injures the quality. Therefore, since it is not necessary to put the brew over the fire, it is possible to make use of the hygienic advantages of a glassware, porcelain, or earthenware serving pot.

**BOILED (OR STEEPED) COFFEE.** For boiling (or steeping) use a medium grind. The recipe is a rounded tablespoonful for each cup of coffee desired or—as some cooks prefer to remember it—a tablespoonful for each cup and "one for

<sup>8</sup> *Tea and Coffee Trade Jour.*, 1921 (vol. xli: no. 5: p. 688).

the pot." Put the dry coffee in the pot and pour over it fresh water *briskly boiling*. Steep for five minutes or longer, according to taste, over a low fire. Settle with a dash of cold water or strain through muslin or cheesecloth and serve at once.

**PERCOLATED COFFEE.** Use a rounded tablespoonful of medium fine ground coffee to each cupful of water. The water may be poured into the percolator cold or at the boiling point. In the latter case, percolation begins at once. Let the water percolate over the grounds for five or ten minutes depending upon the intensity of the heat and the flavor desired.

As a step in its program of direct practical service to the trade, the Associated Coffee Industries of America published and circulated among its members, in 1934, the first of a series of reports covering the results of research work on coffee and coffee brewing as conducted by Dr. Marion G. Frank, director of the Association's Research Bureau, sponsored by the National Federation of Coffee Growers of Colombia. Under the general title, "The Correctness of Grind in Relation to Coffee Brewing," Dr. Frank, who is a qualified authority on the chemistry of foods, discussed the particle-size of coffee grinds in their relation to correct coffee brewing. He said in part:

It is imperative that if the full flavor of the coffee is to be extracted, the grind must be right; and inasmuch as the brewing devices commonly found in the home are not used to capacity, the importance and uniformity of the grind become all the more vital. To verify the importance of the grind, brewing tests were made on batches of coffee ground to different average size. The grinder was of a well-known retail-store variety, capable of adjustable performance from "fine" to "coarse." Grinds of numbers 3, 4, 5, 6, and 7 as shown on the adjustment knob were used, the coarseness increasing with the higher numbers. Coffee beverage was brewed to capacity from each of these grinds in an eight-cup drip pot. The experiment was repeated in a six-cup drip pot of the same make. A third experiment consisted in brewing from these same grinds four cups of coffee in the six-cup pot. The ratio of coffee to water was kept constant, 8 grams of coffee being used to every cup of 150 cc. of water. The coffee was of the same blend and roast throughout. It was roasted on each occasion just before the tests were made. The flavor strength of the respective brews was determined by comparison with coffee infusions containing varying amounts of coffee. If, for instance, a brew gave a flavor equal to that of an infusion containing the same ratio of coffee to water, its flavor was adjudged 100 per cent. The experiments showed: (1) that as the coarseness of the grind increased, the flavor strength decreased, (2) that the flavor strength fell off more rapidly with increase in grind coarseness as the capacity of the pot diminished, (3) that full flavor strength is not so likely to be

achieved when the pot is not used to capacity, and (4) that flavor strength fell off most rapidly when the pot was not used to capacity.

The Ro-Tap, a machine for testing the uniformity of coffee grinds and to provide a check on the constancy of the grinding apparatus, is an excellent device, furnishing a thoroughgoing detailed analysis. But not many plants are equipped with the Ro-Tap, and it is mainly for these that a simpler, less expensive machine, called the "Rotary Analyzer," has been designed to make rough, daily tests. It is recommended that a sample batch of ground coffee be put through the Ro-Tap once every month as a check on the Rotary Analyzer. If the Ro-Tap analysis corresponds with that of the previous month, the figures obtained from the Rotary Analyzer are to be used as the standard to which the daily runs are referred throughout the month. The Association has arranged to secure these Rotary Analyzers for members, at cost of production.

Perhaps the most significant development in connection with household coffee brewing in the United States during the last decade is the endeavor of coffee roasters to tie-in their brands with the brewing devices that will insure the most correct brewing. Various types of coffee makers have been selected, but the drip or filtration type is the one generally favored. Prior to this movement, coffee men were reluctant to attempt to instruct or even to suggest to consumers the best way to make coffee; in fact, coffee men could not agree among themselves on this subject. However, they now realize fully that the product can be ruined in the making, and are paying more and more attention to this vital factor in its final preparation.

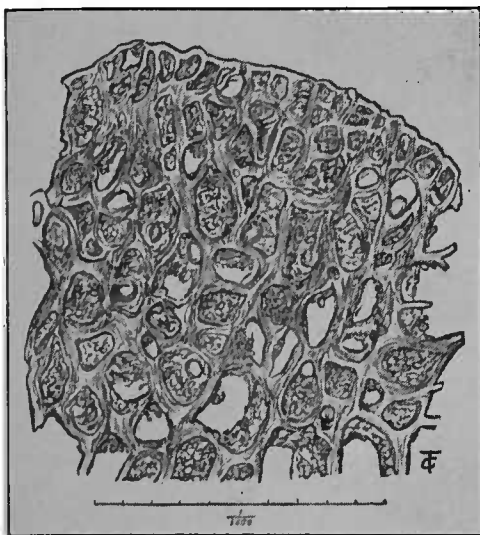
In response to a request by the author, Charles W. Trigg contributed the following discussion of coffee making:

#### SCIENTIFIC COFFEE BREWING

Before converting it into the beverage form, coffee must be carefully selected and blended, and skillfully roasted, in order thus far to assure obtaining a maximum efficiency of results. No matter how accurately all this be done, improper brewing of the roasted bean will nullify the previous efforts and spoil the drink; for roasted coffee is a delicate material, very susceptible to deterioration and of doubtful worth as the source of a beverage unless properly handled.

There probably never was produced a drink which so fits into the exacting desires of the human appetite as does coffee. Properly prepared, it is a delightful beverage; but incorrectly made, it becomes an imposition upon the palates of mankind. Sensitive though coffee is to improper manipulation, the best procedure for brewing it is also the easiest. Cheap coffee well made excels good coffee poorly made.





SECTION OF ROASTED BEAN MAGNIFIED 1,000 TIMES

**CONSTITUENT CONCEPTS.** The roasting of green coffee causes an alteration in the constitution of its constituents, with the result that some of the compounds present therein which were originally water-soluble are rendered insoluble, and some which were insoluble are converted into soluble ones. A portion of the original caffeine content is lost by sublimation. The aromatic conglomerate, *cafféol*, is formed, and a considerable quantity of gas is produced, a portion of which, developing pressure in the cells of the beans, pops, or swells, them so as to increase the size of each individual bean. The constituents which are water-soluble after the torrefaction may be generally classified as heavy extractives and light aromatic materials. The percentages and nature of these materials in the roasted coffee will vary with the type of coffee and with the roast which it is given. In general, and in particular for purposes of comparison of methods of brewing, they may be considered to be the same and to occur in about the same proportions in all coffees.

The heavy extractives are caffeine, mineral matter, proteins, caramel, and sugars, "caffetannic acid," and various organic materials of uncertain composition. Some fat will also be found in the average coffee brew, being present not by virtue of being water soluble, but because it has been melted from the bean by the hot water and carried along with the solution.

The caffeine furnishes the stimulation for which coffee is generally consumed. It has only a slightly bitter taste, and because of the relatively small percentage in which it is present in a cup of coffee, does not contribute to the cup value. The mineral matter, together with certain decomposition and hydrolysis products of crude fiber and chlorogenic acid, contribute toward the astringency or bitterness of the cup. The proteins are present in such small quantity, that their only rôle is to raise somewhat the almost negligible food value of a coffee infusion. The body, or what might be called the licorice-like character of coffee, is due to the presence of bodies of a glucosidic nature and to caramel.

As has been previously pointed out,<sup>9</sup> the term "caffetannic acid" is a misnomer; for the substances which are called by this name are in all probability mainly *cafféol* and chlorogenic acids. Neither is a true tannin, and they evince but few of the characteristic reactions of tannic acid. Some neutral coffees will show as high a "caffetannic acid" content as other acid-charactered ones. Careful work by Warnier<sup>10</sup> showed the actual acidities of some East Indian coffees vary from 0.013 to 0.033 per cent. These figures may be taken as reliable examples of the true acid content of coffee, and though they seem very low, it is not at all incomprehensible that the acids which they indicate produce the acidity in a cup of coffee. They probably are mainly volatile organic acids together with other acid-natured products of roasting.

We know that very small quantities of acid are readily detected in fruit juices and beer, and that variation in their percentages is quickly noticed, while the neutralization of this small amount of acidity leaves an insipid drink. Hence it seems quite likely that this small acid content gives to the coffee brew its essential acidity. A few minor experiments on neutralization have proven the production of a very insipid beverage by thus treating a coffee infusion. So that the acidity of certain coffees most apparently should be attributed to such compounds, rather than to the misnamed "caffetannic acid."

The light aromatic materials, and the other substances which are steam-distillable, i. e., which are driven off when coffee is concentrated by boiling, are the main determining factors in the individuality of coffees. These compounds, which are collectively called "*cafféol*," vary greatly in the percentages present in different coffees, and thus are largely responsible for our ability to distinguish coffees in the cup. It is these compounds which supply the pleasingly aromatic and appetizing odor to coffee.

All of these compounds, with the possible exception of the proteins, are easily soluble in both hot and cold water. The fact that a clear coffee extract made with hot water does not show any precipitate immediately upon cooling, proves that cold water will give as complete an extraction as hot water. However, speed of extraction is materially increased with rise in temperature, due to the fact that the rate and degree of solubility of the substances in water, and the diffusion of the water through the cell walls of the coffee, are accelerated. Also, the resistance which the fat content of the bean offers to the wetting of the coffee, and the persistency of the "enfleurage" action of the fat in retaining the *cafféol*, are less with hot than with cold water. Accordingly, the speed of extraction is increased by using hot water, and the efficiency of extraction procured per unit time of subjection to water is higher.

Prolonged contact of coffee with water results in the hydrolysis of some of the insoluble materials and subsequent extraction of the substances thus formed. The rate of hydrolysis also increases with temperature: and as these compounds are of an astringent or bitter nature, the solution obtained upon boiling coffee is naturally

<sup>9</sup> See chapter XXIV.

<sup>10</sup> *Pharm. Weekbl. voor Nederl.*, No. 13, 1899. *Apoth. Ztg.*, 1899 (p. 14).

possessed of a flavor unpleasant to the palate of the connoisseur. Boiling of the coffee infusion after it has been removed from the grounds also has a deleterious effect, as the local overheating of the solution at the point of application of the heat results in a decomposition, particularly if the solution be converted into steam at this point, leaving a thin film of solids temporarily exposed to the destructive action of the heat. Some of the more delicate constituents are unfavorably affected by such treatment, and undergo hydrolysis and oxidation. The products thus formed are thrown into relief in the flavor by the loss of the aromatic properties through steam distillation which is incidental to boiling.

It is a well-known fact that re-warming a coffee brew has an unfavorable effect upon it. This is probably due in part to a precipitation of some of the water-soluble proteins upon standing, and their subsequent decomposition when heat is applied directly to them in reheating the solution. The absorption of air by the solution upon cooling, with attendant oxidation, which is accentuated by the application of heat in re-warming, must also be considered, as well as the other effects of boiling as set forth, and the action of the materials of which the coffee pot is constructed upon the solution.

**PHYSICAL CONCEPTION.** The coffee bean is composed of a large number of cells which function as natural containers and retainers of coffee fat and of the aromatic flavoring substances. In order to render the soluble solids fully accessible, the resistance which these cells offer to the extracting water must be overcome by grinding so as to break open all of them. In this manner a grind is obtained which will give a maximum removal of the heavy extractives. But when all of the cells are broken, great opportunity is offered for the escape of the caffeol, which is further enhanced by the slight heating which usually accompanies such fine grinding. So much caffeol escapes that even our most expert cup-testers would experience difficulty in identifying powdered coffees in a blind test. What cup-testers, in fact, use powdered coffees for making their cup selections?

Consider powdered coffee, compared with freshly ground coffee of a coarser grind. Neither the former nor its brew possesses the amount of characteristic flavor or aroma, attributable to caffeol, evidenced by the latter. The explanation of this is that the finer the grind, the more readily accessible are the soluble constituents of the coffee to the extracting water. Caffeol, however, in addition to being water-soluble, is extremely fugacious, so that when the grinding is carried to such a fineness that every cell is broken, the greater part of the caffeol volatilizes before the water comes into contact with it. It is therefore highly desirable that a grind be used wherein all of the cells are not broken, but a grind that is sufficiently fine to permit efficient extraction. In the light of this knowledge, the grind advocated by King<sup>21</sup> seems to be logical, for with it—though neither a maximum of the non-volatile extractives nor a maximum of caffeol is obtained—an all-around maximum of cup quality is procured.

<sup>21</sup> *Tea and Coffee Trade Jour.*, 1917 (vol. xxxiii: pp. 552-55).

The escape, upon grinding, of these volatile aromatic, and flavoring constituents which lend individuality to coffees, makes it essential that the roasted beans be ground immediately prior to extraction.

**DIFFERENT METHODS OF EXTRACTION.** The methods employed for preparing the coffee drink may be classified under the general headings of boiling, steeping, percolation, and filtration. True percolation is the simple process known by the trade as filtration; but in this classification, the term indicates the style of extraction exemplified by the pumping percolator.

Boiled coffee is usually cloudy, due to the suspension of fine particles resulting from the disintegration of the grounds by the violence of boiling. The usual procedure in clarifying the decoction is to add the white of an egg or some egg-shells, the albumen of which is coagulated upon the fine particles by the heat of the solution, and the particles thus weighted sink to the bottom. Even this procedure, requiring much attention, does not give as clear a solution as some of the other extraction procedures. The conditions to which coffee is subjected during boiling are the worst possible, as both grounds and solution undergo hydrolysis, oxidation, and local overheating, while the caffeol is steam-distilled from the brew. Many persons, who have long been accustomed to drinking the relatively bitter beverage thus produced, are not satisfied by coffee made in any other way; but this is purely a perversion of taste, for none of the properties are present which make coffee so prized by the epicure.

Steeping, in which cold water is added to the coffee, and the mixture brought up to a boil, does not subject the coffee to so strenuous conditions. Local overheating and hydrolysis occur, but not to so great an extent as in boiling; and most of the effects of oxidation and volatilization of caffeol are absent. However, extraction is rather incomplete, due to lack of thorough admixture of the water and coffee.

When coffee is to be made under the best conditions, the temperature of the water used and of the extract after it is made should not fluctuate. In the pumping percolator, as in the steeping method, the temperature varies greatly from the time the extraction is started to the completion of the operation. This is deleterious. Also, local overheating of the infusion occurs at the point of application of the heat; and because of the manner in which the water is brought into contact with the coffee, the degree of extraction shows inefficiency. Spraying of the water over the coffee never permits the grounds to be completely covered with water at any one time, and the opportunity offered for channeling is excessive. The principle of thorough extraction demands that, as the substance being extracted becomes progressively more exhausted, fresh solvent should be brought into contact with it. In the pumping percolator the solution pumped over the grounds becomes more concentrated as the grounds become exhausted; so that the time taken to reach the degree of extraction desired is longer, and an appreciable amount of relatively concentrated liquor is retained by the grounds.

The simplest procedure to follow is that in which boiling water is poured over ground coffee suspended on a filtering medium in such a man-

ner that the extracting water will slowly pass through the coffee and be received in a containing vessel, which obviates further contact of the beverage with the grounds. The water as it comes into contact with the ground coffee extracts the soluble material, and the solution is removed by gravity. Fresh water takes its place; so that, if the filter medium be of the proper fineness, the water flows through at the correct rate of speed, and complete extraction is effected with the production of a clear solution. Thus a maximum extraction of desirable materials is obtained in a short time with a minimum of hydrolysis, oxidation, and loss of caffeol; and if the infusion be consumed at once, or kept warm in a contrivance embodying the double-boiler principle, the effects of local overheating are avoided. Also, with the use of an appropriate filter, a finer grind of coffee can be used than in the other devices, without obtaining a turbid brew. All this works toward the production of a desirable drink.

There are several devices on the market, some using paper, and some cloth, as a filter, which operate on this principle and give very good coffee. The use of paper presents the advantage of using a new and clean filter for each brew, whereas the cloth must be carefully kept immersed in water between brews to prevent its fouling.

Contrivances operating on the filtration principle have been designed for use on a large scale in conjunction with coffee urns, and have proven quite successful in causing all of the water to go slowly through the coffee without channeling, thus accomplishing practically complete extraction. The majority of urns are still operated with bags, of which the ones with sides of heavier material than the bottom obtain the most satisfactory results, as the majority of the water must pass through the coffee instead of out through the sides of the bag. Greatest efficiency, when bags are used, is obtained by repouring until all of the liquid has passed twice through the coffee; further repouring extracts too much of the astringent hydrolysis products. The bags, when not in use, should not be allowed to dry but should be kept in a jar of cold water. The urns provided with water jackets keep the brew at almost a constant temperature and avoid the deterioration incident to temperature fluctuation.

**COMPOSITION OF BREWS.** The real tests of the comparative values of different methods of brewing are the flavor and palatability of the drink, in conjunction with the number of cups of a given strength which are produced, or the relative strengths of brews of the same number of cups volume. Chemical analysis has not yet been developed to a stage where the results obtained with it are valuably indicative. Caffeol is present in quantities so small that no comparative results can be obtained. "Caffetannic acid" determinations are practically meaningless. This compound is of so doubtful a composition and physiological action, and the methods employed for its determination are so indefinite as to interpretation, as to render valueless any attempts at comparison of relative percentages. The only accurate analysis which can be made is that for caffeine.

Much advertising emphasis has been placed on the small amount of caffeine extracted by some devices. What is one of the main reasons for the consumption of coffee? The caffeine contained therein, of course. So that if one device extracts

less caffeine than another, that fact alone is nothing in favor of the former. If the consumer does not want caffeine in his drink there are caffeine-free coffees on the market.

The coffee liquor acts on metals in such a manner as to lower the quality of the drink, so that metals of any sort, and by all means, irons, should be avoided as far as possible. Instead, earthenware or glass, preferably a good grade of the former, should be employed as far as possible in the construction of coffee-making devices.

Of the various metals, silver, aluminum, monel metal, and tin (in the order named) are least attacked by coffee infusions; and besides these, nickel, copper, and well enameled iron (absolutely free from pin holes) may be used without much danger of contamination. Rings for coffee-urn bags should be made of tinned copper, monel metal, or aluminum. Even if coffee be made in metal contrivances, the receptacles in which it stands should be made of earthenware or of glass.

Painstaking care should be given to the preservation of the coffee-makers in a state of cleanliness, as upon this depends the value of the brew. Dirt, fine grounds, and fat (which will turn rancid quickly) should not be allowed to collect on the sides, bottom, or in angles of the device difficult of access. Nor should any source of metallic or exterior contamination be allowed to go uneliminated.

Responding to the author's request, Dr. S. C. Prescott, Dean of Science and Head of the Department of Biology and Public Health, Massachusetts Institute of Technology, Cambridge, has contributed the following more recent discussion of coffee making:

#### PREPARATION OF THE BEVERAGE

Much study has been given to the most satisfactory way to prepare this delightful and stimulating drink, for it is a fact that the most excellent coffee which can be grown and prepared by proper roasting can be ruined by improper methods of preparation for the table. The quality of the most satisfying beverage coffee is obtained only when it possesses fine aroma, delicacy of flavor, and fullness of body as well as warmth and stimulating character. These properties can be assured only when attention is paid to certain details—the freshness of the roasted coffee, a fineness of grind that permits rapid and effective extraction yielding a clear and brilliant infusion, a method of treatment involving time, temperature and equipment, which conserves the delicate volatile constituents inherent in the freshly roasted bean, but avoids the woody and bitter flavors that are invariably found in coffee which has been too long exposed to the solvent action of water on the ground material.

Roasted coffee retains its characteristic freshness for comparatively few days. When exposed to air it gradually acquires a dullness or a flatness of flavor, and eventually a staleness in odor and taste that rob it of its pleasing effect on the sense organs of smell and taste. The exact changes which take place are unknown, although one marked feature is the reduction in the amount

of carbon dioxide that is held in occluded or absorbed condition within the roasted bean. This loss seems in part at least to be a gaseous interchange between carbon dioxide and oxygen, and in coffee exposed freely to air the change in taste is begun within two or three days after roasting, and produces changes in flavor which may be readily detected by the fourth or fifth day. Obviously if the coffee is hermetically sealed, as in the vacuum pack, these marked changes do not occur until the package is opened and air exposure takes place.

Three methods of brewing coffee are in common use, and may be briefly considered:

1. The old-fashioned method of preparing coffee by boiling.

2. The use of the so-called percolators, in which the coffee grounds are repeatedly sprayed by successive portions of water and then of the infusion itself as it results from the long continued action.

3. The use of devices of various types which produce filtered or "drip" coffees; i. e., prepared by the single, or sometimes repeated, passage of hot water through the mass of ground coffee, the infusion passing into a receptacle below.

In the first and second of these methods the temperature is too high and the time of treatment too long for best results. The volatile constituents are lost and the coffee becomes "strong" not because of increased caffeine content but on account of the larger quantity of dissolved coloring matters, woody extract and other slowly soluble ingredients. The third method lends itself to a definite control of temperature, time of contact of water and coffee and retention of the desired substances and exclusion of those less desirable.

What follows is an extract from the report of an investigation of coffee made by the writer, presenting some of the more important features in relation to the brewing of coffee:

Since beverage coffee is an infusion, it follows that the composition of the liquid after infusion will depend upon the amount of the various soluble constituents which are removed by the water treatment, and therefore directly related to the duration of the infusion, the temperature employed, the concentration or relative amounts of ground coffee and water used, the solubility of the various constituents in the ground coffee, and to the character of the materials and apparatus used. Coffee brewing, therefore, is a complex chemical reaction rather than a mechanical process of mixing or compounding inert ingredients.

To determine the "best" method of preparing beverage coffee requires the investigation of each of the factors or conditions concerned in the process, and the interpretation of the results not only in terms of chemistry and biology, but also in terms of the reaction of the consumer.

The factors to be considered include:

- (a) The coffee itself—its freshness, degree of roast and fineness of grind.
- (b) The character of the water.
- (c) The temperature of the water.
- (d) The character of the container used in infusing.
- (e) The infusion time.
- (f) The strength of the infusion.
- (g) The effect of addition of other substances.

While the results of certain of these factors may be directly measured, as for example, the amount of extract from a given mixture of coffee and water under fixed conditions of time and temperature, such results would mean little to the average consumer of coffee and would give no indication of its quality as a beverage.

One of the most important factors pertaining to the preparation of coffee seems to be the temperature employed to prepare the extract, or in other words, at which the coffee is made. If medium or finely ground coffee in suitable quality is added to water at the boiling point, a slight lowering of the temperature takes place, amounting probably to 3 or 4 degrees. If the coffee is freshly ground, an action which may be perhaps most easily described as simulating effervescence takes place. Vigorous foaming ensues, gas bubbles are formed and buoy up the particles of coffee, then pass off into the air, and then the coffee grounds settle or boil quietly, and the soluble substances are more or less completely extracted. While at first the cause of the foaming was not certain, it was later found to be due to the expulsion of carbon dioxide occluded in the roasted coffee. It is possible that changes in the protein substances of the bean are also brought about, driving off the gas. The change seems to occur most explosively at a temperature somewhere between 95 degrees C., or a few degrees below, and so serves as a general indicator of the temperature. If we make an infusion of coffee at temperatures below this, never permitting the liquid to boil, the evolution of gas which results is far less vigorous and the resulting coffee infusion is freer from certain bitter or astringent flavors than that which is made at the higher temperature.

In order to determine whether temperature produces a marked change in the quality of the beverage coffee, an extended series of practical tests was carried out, using groups of individuals as the means for determining popular opinion. In general, a fairly large percentage preferred coffee which not only had not been brought to the boiling temperature, but which had been prepared at temperatures considerably below this point. We compared, for example, coffee made at a temperature of 85°C. (185°F.), coffee made at a temperature of from 90° to 93°C., coffee made above 95° but below the boiling point, and coffee which had been brought to the boiling point, and coffee which had been boiled at brief intervals, such as a minute and one and one-half minutes. The preference was for coffee made at the lower temperatures, whereas coffee made at boiling temperatures, or coffee actually boiled for a short time was looked upon with comparative disfavor.

The importance of this to the housewife, the hotel or restaurant manager is evident, for the result of many tests showed that the maintenance of the lower temperature secures coffee that is more palatable to the average consumer. There is also, conceivably, an important physiological aspect of the problem, for it may be that the more complex changes, or more marked chemical actions brought about at the boiling temperature decompose certain substances in the bean with the formation or setting free of materials which are not only prejudicial to the taste of the coffee, but may also have a direct physiological effect of undesirable character.



Another matter which seems to be of far greater importance than has been ordinarily supposed is the effect of metals upon the taste or flavor of beverage coffee. Inferentially, there arises also the even more important question as to whether the physiological action of coffee may not be similarly affected.

Coffee brewed in metal gives tastes variously described as "astringent," "metallic," "disagreeable," "bitter," or "puckery," in contrast to the smoother and more delicate flavor of the product made in glass. The differences in taste are most easily recognized by those unaccustomed to coffee-drinking and by those who are not regularly obtaining their morning cup of coffee from a metal pot. To the latter, the taste imparted by the container is sometimes regarded as an essential part of the taste of the coffee itself, and the beverage prepared in glass or china ware may at first taste "flat." In other words, the taste to which one is accustomed is likely to be regarded by the consumer as the normal taste. It requires little training, however, to detect the difference in actual flavor, regardless of one's particular experience. When group tests were carried out the results were of very definite significance.

Consideration of these results in the light of what we know of the chemistry of these metals seems to indicate a direct relation between the two. Organic chemists have shown that combinations between organic substances and metals are of frequent occurrence. It has been pointed out that caffeine and mercury form such a definite compound, and many others are known. Action of metals in modifying taste of numerous food substances is a matter of not uncommon experience. It is fairly obvious that many metals might yield pronounced flavors when cooked with an organic solution such as a coffee infusion. Iron has long been known to do so, and we find similar results with tin, aluminum, tinplate, copper, and nickel. There has been a tradition that silver produces a distinctive taste in coffee.

Without going into all the details, the results of studies on coffee making may be condensed into the following summary:

1. Very hard or very alkaline waters exert an unfavorable influence on the character of beverage coffee. Ordinary soft waters or waters of low hardness may be used without notable difference in the quality of the beverage.

2. The temperature of the water plays an important part in coffee making. Actual boiling increases the bitter taste. The most favorable temperatures seem to range from 85°C. to 95°C. (185° F. to 203° F.), as at these temperatures the caffeine is nearly all dissolved, the flavor-giving oils or ethers are not so largely boiled off and certain changes resulting in bitterness and woody taste are absent or negligible.

3. The time of infusing should be brief. In general, it should not exceed two minutes at the temperatures stated above. One minute is even better. Long infusion, even at the lower temperatures, increases the bitter taste and decreases the flavor and aroma.

4. About 80 per cent of the caffeine is dissolved in two minutes at the boiling point and nearly as much at 95°C.

5. Coffee boiled for one minute is markedly more bitter than that prepared at 95°C.

6. The action of coffee infusion on metals is

pronounced, and bitter, astringent, or metallic tastes may be produced.

7. Tin-plate, aluminum, copper, and nickel all affect the taste of coffee, and in general in the order named, tin-plate being the most objectionable in this respect.

8. Glass, porcelain, stone ware, agate and other vitrified wares exert no influence on the taste of coffee.

9. Some metals form compounds with caffeine, and probably also with other constituents of coffee.

10. The effect of metals is somewhat masked by use of sugar and cream. These adjuncts are levelers from the standpoint of taste. A coffee that may be very bitter in the clear condition, may lose a great deal of that bitter taste when sugar and cream are added in suitable proportions; so that it is much easier to carry on these comparative tests in the clear coffee than it is in coffee when sugar and cream are added, although we have made our tests both ways and the results are comparable in both ways.

11. Freshly roasted and freshly ground coffee are necessary for the best flavor.

12. Coffee in the bean retains its flavor longer than in ground form.

13. The fineness of the grind exerts an influence on the flavor. In general, a fine grind yields a richer flavor than a coarse grind because of the more rapid and complete solution of the flavor-giving substances. The grind should, however, be adapted to the method of brewing.

14. It is desirable to grind the coffee beans immediately before infusing if one wishes to secure and conserve all the available flavor and aroma.

15. Different types of coffee have their characteristic flavors which may be detected by the expert. Even coffee of low commercial grade, if freshly roasted, freshly ground and properly brewed will be superior to coffees of higher grade which have not been suitably stored to prevent oxidative changes, or which are badly prepared.

16. We believe the best results will be obtained with freshly roasted coffee, infused at temperatures 185° to 195°F. for not over two minutes in a glass, porcelain, or vitrified container, and immediately filtered from the grounds.

### *The Perfect Cup of Coffee*

Lovers of coffee in the United States are in a better position to obtain an ideal cup of the beverage than those in any other country. While imports of green coffee are not so carefully guarded as tea imports, there is a large measure of government inspection designed to protect the consumer against impurities, and the Department of Agriculture is zealous in applying the pure food laws to insure against misbranding and substitution. The department has defined coffee as "a beverage resulting from a water infusion of roasted coffee and nothing else."

Today no reputable merchant would think of selling even loose coffee for other





*The Gorham Company*

MODERN AMERICAN TEA AND COFFEE SERVICE, COLONIAL PATTERN

than what it is. And the consumer can feel that, in the case of package coffee, the label tells the truth about the contents.

With a hundred different kinds of coffee coming to this market from more than a score of producing countries, so many combinations are possible that there is sure to be a straight coffee or a blend to suit any taste. And those who may have been frightened into the belief that coffee is not for them should do a little experimenting before exposing themselves to the dangers of the coffee-substitute habit.

Once upon a time it was thought that Java and Mocha was the only worth-while blend, but now we know that combinations of various growths make a satisfying drink. And if the individual seeker should happen to be caffeine-sensitive, there are coffees so low in caffeine content, like some Puerto Ricans, as to overcome this objection; while there are other coffees from which the caffeine has been removed by a special treatment. There is no reason why any person who is fond of coffee should forego

its use. Paraphrasing Makaroff: Be modest, be kind, eat less, and think more, live to serve, work and play and laugh and love—it is enough! Do this and you may drink coffee without danger to your immortal soul.

Some connoisseurs still cling to the good old two-thirds Java and one-third Mocha blend, but the author has for years found great pleasure in a blend composed of half Medellin, one-quarter Mandheling, and one-quarter Mocha. However, this blend might not appeal to another's taste, and the component parts are not always easy to get.

Another pleasing blend is composed of a high grade Columbian, washed Maracaibo, and Santos, equal parts. In the stores of one of the large chain systems an excellent blend may be had composed of sixty per cent Bourbon Santos, and forty per cent Colombian.

If you are epicurean, you will want to read up on, and to try, the fancy Mexicans, Cobans, Sumatra growths, Meridas, and

some from the "Kona side" of Hawaii.

In preparing the perfect cup of coffee, then, the coffee must be of good grade, and fresh. It should, if possible, be ground just before using. The author has found a fine grind, about the consistency of fine granulated sugar, the most satisfactory. For general home use, a device that employs filter paper or filter cloth is best; for the epicure an improved porcelain French drip pot or an improved cloth filter will yield the utmost of coffee's delights. Drink it black, sweetened or unsweetened, with or without cream or hot milk, as your fancy dictates.

It should be remembered that to make good coffee no special pot or device is necessary. Good coffee can be made with any china vessel and a piece of muslin. But to make it in perfection pains must be taken with every step in the process from roaster to cup.

Hollingworth<sup>12</sup> points out that through taste alone it is impossible to distinguish between quinine and coffee, or between apple and onion. There is something more to coffee than its caffeine stimulus, its action on the taste-buds of the tongue and mouth. The sense of smell and the sense of sight play important rôles. To get all the joy there is in a cup of coffee, it must look good and smell good, before one can pronounce its taste good. It must woo us through the nostrils with the wonderful aroma that constitutes much of the lure of coffee.

And that is why, in the preparation of the beverage, the greatest possible care should be observed to preserve the aroma until the moment of its psychological release. This can only be done by having it appear at the same instant that the delicate flavor is extracted—roasting and grinding the bean much in advance of the actual making of the beverage will defeat this object. Boiling the extraction will perfume the house; but the lost fragrance will never return to the dead liquid called coffee, when served from the pot whence it was permitted to escape.

To recapitulate, the correct way to make coffee is as follows:

1. Buy a good grade of coffee and make sure that it is properly ground for the type of brewing device used.

2. Allow a rounded tablespoonful for each beverage cup.

3. Make it in a French drip pot or in some filtration device where freshly boiling water is poured through the grind but once.

4. Avoid pumping percolators, or any device for heating water and forcing it repeatedly through the grounds. Never boil coffee.

5. Keep the beverage hot and serve it "black" with sugar and hot milk, or cream, or both.

#### *Individual Coffee Bags*

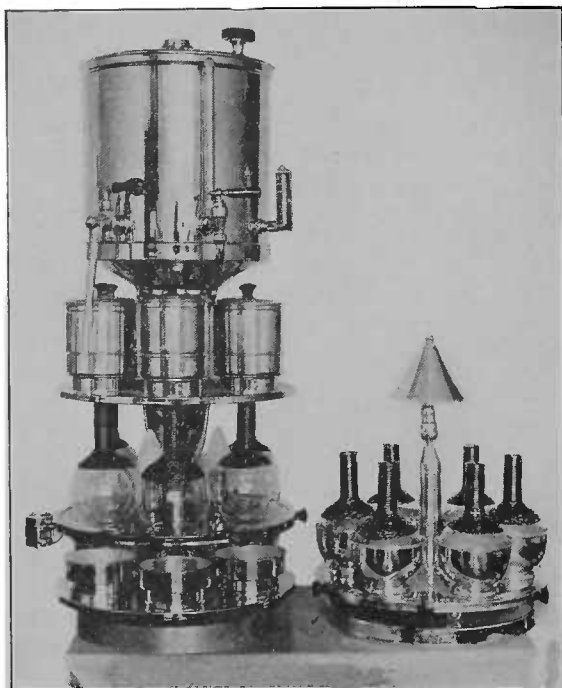
In 1935, Heyman Process Corporation, of New York, developed an "instant" or semi-soluble coffee which they pack in individual gauze bags; with strings and tags, looking like the individual tea bags which are widely used in the United States, and designed to be used in the same manner. Each bag contains the right amount for the preparation of two cups of coffee. The process is covered by U. S. patent 1,527,304 (1925). It is claimed that the granules produced by this process contain twice as much soluble coffee substance as does ordinary coffee, and that it is instantly available for the hot water. The strength of the beverage is determined by the length of time the bag is allowed to remain in the water. Among the advantages claimed are saving of time, the elimination of coffee "grounds" and coffee pot washing.

#### *Flake Coffee*

Incidental to the coffee researches being conducted at the Mellon Institute of Industrial Research under the auspices of the Continental Can Company, a process was developed for producing what is termed flake coffee, as covered by the basic United States patent number 1,903,362.

Flake coffee is produced by rolling especially prepared granulated coffee under high pressure, resulting in extremely thin flakes. In the process nearly all the cells are broken or crushed and the whole particles are flattened and compacted to a round or oval platelet having generally a slightly darker color than regular ground coffee because of the increased density and the oil which shows slightly on the surface. Reduction of the cellular space gives a particle of about one-half the original volume. All of the flakes are of uniform size and

<sup>12</sup> Hollingworth, H. L. and Poffenberger, A. T., Jr. *The Sense of Taste*, 1917 (p. 13).



DE VRY FRENCH DRIP RESTAURANT COFFEE MAKER  
WITH ROTARY WARMING DEVICE

A recent departure in public coffee making machines which makes fresh coffee in 36-cup batches in 6 bottles in 6 minutes.

but a few thousandths of an inch thick. The uniformity of thickness of the flakes and their extreme thinness are intended to assure equal and rapid extraction. Ten ounces of the flaked product is equivalent in strength to a pound of the average grind. The flake form may be used for any method of brewing and any type of pot.

Preservation of the coffee after being manufactured is accomplished by what is described by the manufacturers as a "cycle" process, which replaces with pure carbon dioxide all but a trace of the air within the can. The cans are sealed and remain at atmospheric pressure except for the small amount of carbon dioxide which re-dissolves in the flake coffee. Semi-automatically controlled machinery is used for its production. A small plant turns out 20 to 24 ten-ounce cans per minute.

The product has not been marketed as yet to any extent and so there has been little opportunity to ascertain its probable reception by consumers.

#### *Coffee as a Flavoring Agent*

Mrs. Ida C. Bailey Allen introduced a booklet which she prepared for the Joint

Coffee Trade Publicity Committee during the Brazil coffee campaign of 1919-23 with the following remarks on the use of coffee as a flavoring agent:

Although coffee is our national beverage, comparatively few cooks realize its possibilities as a flavoring agent. Coffee combines deliciously with a great variety of food dishes and is especially adapted to desserts, sauces and sweets. Thus used it appeals particularly to men and to all who like a full-bodied pronounced flavor.

For flavoring purposes coffee should be prepared just as carefully as when it is intended for a beverage. The best results are obtained by using freshly made coffee, but when, for reasons of economy, it is desirable to utilize a surplus remaining from the meal-time brew, care should be taken not to let it stand on the grounds and become bitter.

When introducing made coffee into a recipe calling for other liquid, decrease this liquid in proportion to the amount of coffee that has been added. When using it in a cake or in cookies, instead of milk, a tablespoonful less to the cup should be allowed, as coffee does not have the same thickening properties.

In some cases, better results are gained if the coffee is introduced into the dish by scalding or cooking the right proportion of ground coffee with the liquid which is to form the base. By this means the full coffee flavor is obtained, yet the richness of the finished product is not impaired by the introduction of water, as would be the case were the infused coffee used. This method is advisable especially for various desserts which have milk as a foundation, as those of the custard variety and certain types of Bavarian Creams, Ice Cream, and the like. The right proportion of ground coffee, which is generally a tablespoonful to the cup, should be combined with the cold milk or cream in the double-boiler top and should then be scalded over hot water, when the mixture should be put through a very fine strainer or cheese cloth, to remove all grounds.

Coffee can be used as a flavoring in almost any dessert or confection where a flavoring agent is employed. Here is a good recipe for a coffee syrup:

**COFFEE SYRUP.** Two quarts of very strong coffee; 3½ pounds sugar. The coffee should be very strong, as the syrup will be largely diluted. The proportion of a pound of coffee to one and three-fourths quarts of water will be found satisfactory. This may be made by any favorite method, cleared and strained, then combined with the sugar, brought to boiling point, and boiled for two or three minutes. It should be canned while boiling, in sterilized bottles. Fill them to overflowing and seal as for grape juice or for any other canned beverage.

**BOOK VI**  
**ARTISTIC ASPECTS**

بِسْمِ اللَّهِ الرَّحْمَنِ الرَّحِيمِ وَبِهِ الْعَوْنُ وَالْعَوْفُ  
 يقول راقم هذه الحروف هو ممنوع بطور هذه الحروف  
 بالصنوفه ففقد عفوس به الغنيه المكي عبد القادر  
 ابن محمد بن عبد القادر بن محمد الانصاري الحزيري  
 الحنبلي بعض المدغرة اعاليه واراش جناح احواله  
 حياه الله الذي اباح لنا ما خصنا به من الطيبات  
 واغدق انعاماته وافضاله بتنوع المطعومات  
 والنبات وسير لاهل واداره معرفته ما يكون معيننا  
 لهم على ما يصدره من الاوراد والعبادات وسقا  
 شرايا ظهور اصفت به من شوايب تهمد انهم  
 ساعاتهم والاقوات هو وفقهم لتناول ما احلله  
 وحاهم من موارد الشبهات والاسهم من المعارف  
 اللدنية ما يكون سببا لثقتهم في المعارج العلية  
 ونزهم عن خبايب الاوصاف وزايل السات  
 وقاها مما يخرج عن امر الشريعة المصطفوية  
 ونور بصايرهم فاستقوا في مدارج مراتب العبودية  
 فليس لهم الي غير جنابه التفات فسيما من  
 ادارته حبه على خواصه وحزبه فها هو اطربا  
 بذلك الشراب انا نخنادس شكوكهم ووضع لهم  
 طريق سلوكهم وازال عن قلوبهم الرين والحجاب  
 اظلم بسمايب جوده وجمع وجدهم في توحيد  
 واصفاتهم

كتاب  
 عمدة المصفوة في حل القهوة  
 تأليف الشيخ الامام السلام  
 الرحلة العظامه عبد القادر  
 ابن محمد الانصاري  
 الحزيري الحنبلي  
 عوف الله  
 عنه  
 ابنه  
 فرنوب الميرزا الباق  
 بن ابوالنور عرق  
 رمضان ١٠٥٦



الدليله وانما واحدا لمتار بها حيث لا خبيثة ولا علة  
 والف في حكمها مولفات بالحل والحرمه وبعده العقول  
 بذلك فمن ميري من المخطور ومن قابل بالوصمة  
 وكان من الف في حكمها وافصح عن بيان وصفها ونفها  
 ان العلامة والامام الفها مده قدوة المحققين ولسان  
 المتكلمين في كتاب الدين احمد بن محمد الغفاري المالكي  
 فزيل طيبة المحبوبة صلى الله في الدار الاخيرة اكره  
 متوتبة وطيب نزله ونزاه وجعل في اعلى عرف الخمان  
 ما واوه وكتب مولفا اعرب فيه عن الانصاف واضحت  
 غيايب الشكوك بما سطع من نور اليقين به واوضح  
 من الخلاف غير انه اوسع في محال الرد على المخالفات  
 الصباية وحاله في ميران البرهان باسنة الافلام  
 وكشف عن ادلة عزيرة محتارة فملتوسع والاطناب  
 فيما اورد من المقالة يكاد ان يوجب لنا نظرية  
 الساسة والمالاه ولتعداد الدليل والنظائر يحصل  
 الفتنور من الفكر الظاهر مع انه جرد مولفه من نكت  
 يكون ايرادها المستفيد بيت الفصيد ونظيره  
 يكون به فرايد فوايد منتظمة لكل باد ومعدة فاحيت  
 ان المنصونه مولفا لطفا معذب به مذاق القوائد  
 واقتطف من ارض هذا التستان ما يطيب ارجح الحبل  
 ماجد واخذ من غير القوائد ما تنصل الصلة منه  
 بالوايد

944  
 Ornat al safaat fi hall al cabuat.  
 de vsu legitimo et hito potionis que  
 vulgo Cafe nuncupatur. authore Abi-  
 alexander Ben Mohommed al Andari.  
 Constat hic liber capitibus septem et  
 ab authore editus est anno hegire 996  
 quo anno centum et viginti <sup>anni</sup> effluxerant  
 ex quo huius potionis vsus in Arabia  
 felice imaluerat.

THE EARLIEST COFFEE MANUSCRIPT, 1587

Pages from the Arabian writing by Abd-al-Kadir, photographed for this work in the Bibliothèque Nationale, Paris.



A HISTORY OF COFFEE IN LITERATURE

THE ROMANCE OF COFFEE, AND ITS INFLUENCE ON THE DISCOURSE, POETRY, HISTORY, DRAMA, PHILOSOPHIC WRITING, AND FICTION OF THE SEVENTEENTH, EIGHTEENTH, AND NINETEENTH CENTURIES, AND ON THE WRITERS OF TODAY—COFFEE IN ANCIENT AND MODERN VERSE—IN DRAMATIC LITERATURE—IN GENERAL LITERATURE—COFFEE QUIPS AND ANECDOTES

ANY study of the literature of coffee comprehends a survey of selections from the best thought of civilized nations from the time of Rhazes (850-922) to Francis Saltus Saltus. We have seen in chapter II how Rhazes, the physician-philosopher, appears to have been the first writer to mention coffee; and was followed by other great physicians, like Bengiazlah, a contemporary, and Avicenna (980-1037).

Then arose many legends about coffee, that served as inspiration for Arabian, French, Italian, and English poets.

Sheik Gemaledin, mufti of Mocha, is said to have discovered the virtues of coffee about 1454, and to have promoted the use of the drink in Arabia. Knowledge of the new beverage was given to Europeans by the botanists Rauwolf and Alpini toward the close of the sixteenth century.

The first authentic account of the origin of coffee was written by Abd-al-Kadir in 1587. It is the famous Arabian manuscript commending the use of coffee, preserved in the Bibliothèque Nationale, Paris, and catalogued as "Arabe, 4590."

Its title written in Arabic is as follows:

معدة	الصفوة	في حل	القهوة
1	2	3	4

which is pronounced (reading right to left:

omdat	as safwa	fi hall	al kahwa
1	2	3	4

or, in the literary style:

omdatu s safwati fi hallu 'l kahwati, which means, literally, (the corresponding words being underlined and numbered)

"The maintenance of purity as  
  
  
 regards the legitimacy of coffee"

or, more freely, "Argument in favor of the legitimate use of coffee."

قهوة kahwa, is the Arabic word for coffee.

The author is Abd-al-Kâdir ibn Mohammad al Ansâri al Jazari al Hanbali. That is, he was named Abd-al-Kadir, son of Mohammed.

*Abd-al-Kadir* means "slave of the strong one" (i.e., of God); while *al Ansari* means that he was a descendant of the *Ansari*; i.e., "helpers," the people of Medina who received and protected the Prophet Mohammed after his flight from Mecca; *al Jazari* means that he was a man of Mesopotamia; and *al Hanbali* that in law and theology he belonged to the well known sect, or school of the Hanbalites, so called after the great jurist and writer, Ahmad ibn Hanbal, who died at Bagdad A. H. 241 (A. D. 855). The Hanbalites are one of the four great sects of the Sunni Mohammedans.

Abd-al-Kadir ibn Mohammed lived in the tenth century of the Hegira—the sixteenth of our era, and wrote his book in 996 A. H. or A. D. 1587. Coffee had then been in common use since about A. D. 1450 in Arabia. It was not in use in the time of the Prophet, who died in A. D. 632; but

he had forbidden the drink of strong liquors which affect the brain, and hence it was argued that coffee, as a stimulant, was unlawful. Even today, the community of the Wahabis, very powerful in Arabia a hundred years ago, and still dominant in part of it, do not permit the use of coffee.

Abd-al-Kadir's book is thought to have been based on an earlier writing by Shihâb-ad-Dîn Ahmad ibn Abd-al-Ghafâr al Maliki, as he refers to the latter on the third page of his manuscript; but if so, this previous work does not appear to have been preserved. La Roque says Shihâb-ad-Din was an Arabian historian who supplied the main part of Abd-al-Kadir's story. La Roque refers also to a Turkish historian.

Research by the author has failed to disclose anything about Shihâb-al-Din save his name—*al Maliki* means that he belonged to the Malikites, another of the four great Sunni sects—and that he wrote about a hundred years before Abd-al-Kadir. No copy of his writings is known to exist.

Page 660 shows the title page of Abd-al-Kadir's manuscript, the first page, the third page, and the fly leaf of the cover, the latter containing an inscription in Latin made at the time the manuscript was first received or classified. It reads:

Omdat al safouat fi hall al cahuat.

De usu legitimo et licito potionis quae vulgo Café nuncupatur. Authore Abdalcader Ben Mohammed al Ansari. Constat hic liber capitibus septem, et ab authore editus est anno hegirae 996 quo anno centum et viginti anni effluerant ex quo huius potionis usus in Arabia felice invaluerat.

The translation of the Latin is:

Concerning the legitimate and lawful use of the drink commonly known as café, by Abdalcader Ben Mohammed al Ansari. The book is composed in seven chapters and was brought out by the author in the year of the Hegira 996, at which time a hundred and twenty years had passed since the use of this drink had become firmly established in Arabia Felix.

#### *Coffee in Poetry*

The Abd-al-Kadir work immortalized coffee. It is in seven chapters. The first treats of the etymology and significance of the word *cahouah* (kahwa), the nature and properties of the bean, where the drink was first used, and describes its virtues. The other chapters are devoted to the church dispute in Mecca in 1511; answer the religious objectors to coffee, and conclude with a collection of Arabic verses

composed during the Mecca controversy by the best poets of the time.

De Nointel, ambassador from the court of Louis XIV to the Ottoman Porte, brought back with him to Paris from Constantinople the Abd-al-Kadir manuscript, and another by Bichivili, one of the three general treasurers of the Ottoman Empire. The latter work is of a later date than the Abd-al-Kadir manuscript, and is concerned chiefly with the history of the introduction of coffee into Egypt, Syria, Damascus, Aleppo, and Constantinople.

The following are two of the earliest Arabic poems in praise of coffee. They date approximately from the period of the first coffee persecution in Mecca (1511), and are typical of the best thought of the day:

#### IN PRAISE OF COFFEE

*Translation from the Arabic*

O Coffee! Thou dost dispel all cares, thou art the object of desire to the scholar.

This is the beverage of the friends of God; it gives health to those in its service who strive after wisdom.

Prepared from the simple shell of the berry, it has the odor of musk and the color of ink.

The intelligent man who empties these cups of foaming coffee, he alone knows truth.

May God deprive of this drink the foolish man who condemns it with incurable obstinacy.

Coffee is our gold. Wherever it is served, one enjoys the society of the noblest and most generous men.

O drink! As harmless as pure milk, which differs from it only in its blackness.

Here is another, rhymed version of the same poem:

#### IN PRAISE OF COFFEE

*Translation from the Arabic*

O coffee! Loved and fragrant drink, thou drivest care away,

The object thou of that man's wish who studies night and day.

Thou soothest him, thou giv'st him health, and God doth favor those

Who walk straight on in wisdom's way, nor seek their own repose.

Fragrant as musk thy berry is, yet black as ink in sooth!

And he who sips thy fragrant cup can only know the truth.

Insensate they who, tasting not, yet vilify its use;

For when they thirst and seek its help, God will the gift refuse.

Oh, coffee is our wealth! for see, wher'er on earth it grows,

Men live whose aims are noble, true virtues who disclose.

## COFFEE COMPANIONSHIP

*Translation from the Arabic*

Come and enjoy the company of coffee in the places of its habitation; for the Divine Goodness envelops those who partake of its feast.

There the elegance of the rugs, the sweetness of life, the society of the guests, all give a picture of the abode of the blest.

It is a wine which no sorrow could resist when the cup-bearer presents thee with the cup which contains it.

It is not long since Aden saw thy birth. If thou doubtest this, see the freshness of youth shining on the faces of thy children.

Grief is not found within its habitations. Trouble yields humbly to its power.

It is the beverage of the children of God, it is the source of health.

It is the stream in which we wash away our sorrows. It is the fire which consumes our griefs.

Whoever has once known the chafing-dish which prepares this beverage, will feel only aversion for wine and liquor from casks.

Delicious beverage, its color is the seal of its purity.

Reason pronounces favorably on the lawfulness of it.

Drink of it confidently, and give not ear to the speech of the foolish, who condemn it without reason.

During the period of the second religious persecution of coffee in the latter part of the sixteenth century, other Arabian poets sang the praises of coffee. The learned Fakr-Eddin-Aboubeckr ben Abid Iesi wrote a book entitled *The Triumph of Coffee*, and the poet-sheikh Sherif-Eddin-Omar-ben-Faredh sang of it in harmonious verse, wherein, discoursing of his mistress, he could find no more flattering comparison than coffee. He exclaims, "She has made me drink, in long draughts, the fever, or, rather, the coffee of love!"

The numerous contributions by early travelers to the literature of coffee have been mentioned in chronological order in the history chapters. After Rauwolf and Alpini, there were Sir Antony Sherley, Parry, Biddulph, Captain John Smith, Sir George Sandys, Sir Thomas Herbert, and Sir Henry Blount in England; Tavernier, Thévenot, Bernier, P. de la Roque, and Galland in France; Della Valle in Italy; Olearius and Niebhur in Germany; Nieuhoff in Holland, and others.

Francis Bacon wrote about coffee in his *Hist. Vitae et Mortis* and *Sylvia Sylvarum*, 1623-27.

Burton referred to it in his *Anatomy of Melancholy* in 1632. Parkinson described it in his *Theatrum Botanicum* in 1640. In 1652, Pasqua Rosée published his

famous handbill in London, a literary effort as well as a splendid first advertisement.

Faustus Nairon (Banesius) produced in Rome, in 1671, the first printed treatise devoted solely to coffee. The same year Du-four brought out the first treatise in French, *De l'usage du caphé, du Thé, et du chocolat*. This he followed in 1684 with his work, *Traitez nouveaux et curieux du café, du thé, et du chocolat*. John Ray extolled the virtues of coffee in his *Universal History of Plants*, published in London in 1686. Galland translated the Abd-al-Kadir manuscript into French in 1699, and Jean La Roque published his *Voyage de l'Arabie Heureuse* in Paris in 1715. Excerpts from nearly all these works appear in various chapters of this work.

Leonardus Ferdinandus Meisner published a Latin treatise on coffee, tea, and chocolate in 1721. Dr. James Douglas, published in London, 1727, his *Arbor yemensis fructum coe ferens, or a discription and history of the Coffee Tree*. This work laid under contribution many of the Italian, German, French, and English scholars mentioned above; and the author mentioned as other sources of information: Dr. Quincy, Pechey, Gaudron, de Fontenelle, Professor Boerhaave, Figueroa, Chabraeus, Sir Hans Sloane, Langius, and Du Mont.

In the seventeenth and eighteenth centuries, the poets and dramatists of France, Italy and England found a plentiful supply in what had already been written on coffee, to say nothing of the inspiration offered by the drink itself, and by the society of the cafés of the period.

French poets, writing in Latin, first took coffee as the subject of their verse. Vanière sang its praises in the eighth book of his *Praedium rusticum*; and Fellon, a Jesuit professor of Trinity College, Lyons, wrote a didactic poem called, *Faba Arabica, Carmen*, which is included in the *Poemata didascalica* of d'Olivet.

Abbé Guillaume Massieu's *Carmen Caffaeum*, composed in 1718, has been referred to in chapter II. It was read at the Academy of Inscriptions. One of the panegyrists of this author, de Boze, in his *Elogé de Massieu*, says that if Horace and Virgil had known of coffee, the poem might easily have been attributed to them; and Thery, who translated it into French, says "it is a pearl of elegance in a rare jewel case."

The following translation of the poem from the Latin original was made for this work:

### COFFEE

*A Poem by Guillaume Massieu of the French Academy*

(A literal prose translation from the original Latin in the British Museum)

How coffee first came to our shores,  
 What the nature of the divine drink is, what its  
 use,  
 How it brings ready aid to man against every  
 kind of evils,  
 I shall here begin to tell in simple verse.  
 You soft-spoken men, who have often tried the  
 sweetness of this drink,  
 If it has never deceived your wishes or mocked  
 your hopes  
 With its empty results, be propitious and lend  
 a willing ear to our song.  
 And may you, O Phoebus, kindly be present, to  
 acknowledge  
 As your gift the power of herbs and healthful  
 plants, and to  
 Dispel sad diseases from our bodies; for they  
 say you are  
 The author of this blessing, and may you spread  
 your  
 Gifts among peoples, and everywhere far and  
 wide throughout the entire world.  
 Across Libya afar, and the seven mouths of the  
 swollen Nile,  
 Where Asia most joyfully spreads in immense  
 fields  
 Rich in various resources and filled with frag-  
 rant woods,  
 A region extends. The Sabeans of old inhabited  
 it.  
 I believe indeed Nature, that best parent of all  
 things,  
 Loved this place more than all others with a  
 tender love.  
 Here the air of Heaven always breathes more  
 mildly.  
 The sun has a gentler power; here are flowers  
 of a different clime;  
 And the earth with fertile bosom brings forth  
 various fruits,  
 Cinnamon, casia, myrrh, and fragrant thyme.  
 Amid the resources and gifts of this blessed  
 land,  
 Turned to the sun and the warm south winds,  
 A tree spontaneously lifts itself into the upper  
 air.  
 Growing nowhere else, and unknown in earlier  
 centuries,  
 By no means great in size, it stretches not far its  
 Spreading branches, nor lifts a lofty top to  
 heaven;  
 But lowly, after the manner of myrtle or pliant  
 broom,  
 It rises from the ground. Many a nut bends  
 its rich branches.  
 Small, like a bean, dark and dull in color,  
 Marked by a slight groove in the centre of its hull.  
 To transplant this growth to our own fields  
 Many have tried, and to cultivate it with great  
 care.

In vain; for the plant has not responded to the  
 zeal  
 And desires of the planters, and has rendered  
 vain their long labor;  
 Before day the root of the tender herb has  
 withered away.  
 Either this has happened through fault of cli-  
 mate, or grudging  
 Earth refuses to furnish fit nourishment to the  
 foreign plant.  
 Therefore come thou, whoever shall be possessed  
 by a love for coffee,  
 Do not regret having brought the healthful bean  
 from the far  
 Remote world of Arabia; for this is its bountiful  
 mother country.  
 The soothing draught first flowed from those  
 regions through other  
 Peoples; thence through all Europe and Asia,  
 and next made its way through the entire  
 world.  
 Therefore, what you shall know to be sufficient  
 for your needs,  
 Do you prepare long beforehand; let it be your  
 care to have collected  
 Yearly a copious store, and providently fill small  
 granaries,  
 As of yore the farmer, early mindful and provid-  
 ent of the future,  
 Collected crops from his fields and garnered them  
 in his barns,  
 And turned his attention to the coming year.  
 None the less, meanwhile, must the utensils for  
 coffee be cared for.  
 Let not vessels suited for drinking the beverage  
 be lacking,  
 And a pot, whose narrow neck should be topped  
 by a small cover  
 And whose body should swell gradually into an  
 oblong shape.  
 When these things shall have been provided by  
 you, let your  
 Next care be to roast well the beans with flames,  
 and to grind them when roasted.  
 Nor should the hammer cease to crush them with  
 many a blow,  
 Until they lay aside their hardness, and when  
 thoroughly ground,  
 Become fine powder; which forthwith pack either  
 in a bag or a box made for such uses.  
 And wrap it in leather, and smear it over with  
 soft wax, lest  
 Narrow chinks be open, or hidden channels.  
 Unless you prevent these, by a secret path gradu-  
 ally small  
 Particles and whatever of value exists, and the  
 entire strength,  
 Would leave, wasting into empty air.  
 There is also a hollow machine, like a small  
 tower, which they  
 Call a mill, in which you can bruise the useful  
 fruit of the  
 Roasted bean and crush it with frequent rubbing;  
 A revolving pivot in the middle, on an easy wheel  
 turning,  
 Twists its metal joints on a creaking stem.  
 The top of the wheel, you know, is pierced with  
 an ivory handle  
 Which will have to be turned by hand, through  
 a thousand revolutions,

And through a thousand circles it moves the pivot.  
 When you put a kernel in, you will turn the handle with quick hand—  
 No delay—and you will wonder how the crackling kernel is  
 With much grinding quickly reduced to a powder.  
 Once only the lower compartment receives on its kindly bosom  
 The crushed grains, which are placed in the very depths of the box.  
 But why do we linger over these less important matters?  
 Greater things call us. Then is it time to drain the sweet draught, either under the new light of the early sun  
 In the morning, when an empty stomach demands food;  
 Or, when, after the splendid feasts of a magnificent table  
 The overburdened stomach suffers from too heavy load, and  
 Unequal to the demands made upon it, seeks the aid of external heat.  
 Then come, when now the pot grows ruddy in the fire  
 Crackling beneath, and you shall behold the liquid, swelling  
 With mingled powdered coffee, now bubble around the brim,  
 Draw it from the fire. Unless you should do this, the force of  
 The water would break forth suddenly, overflowing, and would  
 Sprinkle the beverage on the fire beneath.  
 Therefore, let no such accident disturb your joys. You should keep watch carefully when the water no longer  
 Restrains itself and bubbles with the heat; then return  
 The pot to the fire thrice and four times, until the powdered  
 Coffee steams in the midst of the fire and blends thoroughly with the surrounding water.  
 This soothing drink ought to be boiled with skill, to be drunk  
 With art—not in the way men are wont to drink other beverages—  
 And with reason; for when you shall have taken it steaming from  
 A quick fire, and gradually all the dregs have settled to the  
 Very bottom, you shall not drink it impatiently at one gulp,  
 But rather, sip it little by little, and between draughts  
 Contrive pleasant delays; and sipping, drain it in long draughts,  
 So long as it is still hot and burns the palate.  
 For then it is better, and then it permeates our inmost bones, and  
 Penetrating within to the center of our vitals and our marrow,  
 It pervades all our body with its vivifying strength.  
 Often even merely inhaling the odor with their nostrils, men  
 Have welcomed it, when it has bubbled up from the bottom,  
 More refreshing than the breeze. So much pleasure is there in a delicious odor.

And now there remains awaiting us the other part of our task,  
 To make known the secret strength of the divine draught.  
 But who could hope to understand this wonderful blessing  
 Or to be able to pursue so great a miracle in verse?  
 For really, when coffee has quietly glided into your body,  
 Taking itself within, it sheds a vital warmth through your  
 Limbs, and inspires joyous strength in your heart. Then if  
 There is anything undigested, with fire's help, it heats the  
 Hidden channels, and loosens the thin pores, through which the  
 Useless moisture exudes, and seeds of diseases flee from all your veins.  
 Wherefore come, O you who have a care for your health!  
 You, whose triple chin hangs on your breast, Who drag your heavy stomach of great bulk,  
 It is fitting for you, first of all, to indulge in the warm  
 Beverage; for indeed it will dry the hideous flow of moisture  
 Which oppresses your limbs, and sends forth streams of perspiration from your whole body.  
 And in a short time, the swelling of your fat belly will  
 Gradually begin to decrease, and it will lighten your members, now oppressed by their heavy weight.  
 O happy peoples, on whom Titan, rising, looks with his first light!  
 Here, a rather free use of wine has never done harm,  
 For law and religion forbid us to quaff the flowing bowl.  
 Here one lives on coffee. Here, then, flourishing with joyous strength  
 One pursues life and knows not what diseases are, Nor that child of Bacchus and companion of high living—Gout;  
 Nor what innumerable diseases through this union are ready to attack our world.  
 Yet, indeed, the soothing power of this invigorating drink  
 Drives sad cares from the heart, and exhilarates the spirits.  
 I have seen a man, when he had not yet drained a mighty  
 Draught of this sweet nectar, walk silently with slow gait,  
 His brow sad, and forehead rough with forbidding wrinkles.  
 This same man who had hardly bathed his throat with the sweet  
 Drink—no delay—clouds fled from his wrinkled brow; and  
 He took pleasure in teasing all with his witty sayings.  
 Nor yet did he pursue any one with bitter laughter. For this  
 Harmless drink inspires no desire of offending, the venom  
 Is lacking, and pleasant laughter without bitterness pleases.



And in the entire East this custom of coffee drinking  
 Has been accepted. And now, France; you adopt  
 the foreign custom,  
 So that public shops, one after the other, are  
 opened for  
 Drinking Coffee. A hanging sign of either ivy  
 or laurel invites the passers-by.  
 Hither in crowds from the entire city they  
 assemble, and  
 While away the time in pleasant drinking.  
 And when once the feelings have grown warm,  
 acted upon by  
 The gentle heat, then good-humored laughter, and  
 pleasant  
 Arguments increase. General gaiety ensues, the  
 places about resound with joyous applause.  
 But never does the liquid imbibed overpower  
 weary minds, but  
 Rather, if ever slumber presses their heavy eyes  
 and dulls  
 The brain; and their strength, blunted, grows  
 torpid in the  
 Body, coffee puts sleep to flight from the eyes,  
 and slothful inactivity from the whole frame.  
 Therefore to absorb the sweet draught would be  
 an advantage  
 For those whom a great deal of long-continued  
 labor awaits  
 And those who need to extend their study far  
 into the night.

And here I shall make known who taught the use  
 of this pleasant  
 Drink; for its virtue, unknown, has lain hidden  
 through many  
 Years; and reviewing, I shall relate the matter  
 from the very beginning.

An Arab shepherd was driving his young goats  
 to the well-known  
 Pastures. They were wandering through lonely  
 wastes and cropping  
 The grasses, when a tree heavy with many berries  
 —never seen before—met their eyes.  
 At once, as they were able to reach the low  
 branches, they began  
 To pull off the leaves with many a nibble, and  
 to pluck the tender  
 Growth. Its bitterness attracts. The shepherd,  
 not knowing this,  
 Was meanwhile singing on the soft grass and  
 telling the story of his loves to the woods.  
 But when the evening star, rising, warned him  
 to leave the field,  
 And he led back his well-fed flock to their stalls,  
 he perceived  
 That the beasts did not close their eyes in sweet  
 sleep, but  
 Joyous beyond their wont, with wonderful de-  
 light throughout the  
 Whole night jumped about with wanton leaps.  
 Trembling with sudden  
 Fear, the shepherd stood amazed; and crazed  
 by the sound, he  
 Thought these things were being done through  
 some wicked trick of a neighbor, or by magic  
 art.

Not far from here a holy band of brethren had  
 built their  
 Humble home in a remote valley; their lot it was  
 to chant

Praises of God, and to load his altars with fitting  
 gifts.  
 Although throughout the night the deep-toned  
 bell resounded  
 With great din, and summoned them to the  
 sacred temple, often  
 The coming of dawn found them lingering on  
 their couches,  
 Having forgotten to rise in the middle of the  
 night.  
 So great was their love of sleep!  
 In charge of the sacred temple, revered and  
 obeyed by his  
 Willing brethren, was the master, an aged man,  
 a heavy mass of white hair on head and chin.  
 The shepherd, hastening, came to him and told  
 him the story,  
 Imploring his aid. The old man smiled to him-  
 self; but  
 He agreed to go, and investigate the hidden cause  
 of the miracle.

When he has come to the hills, he observes the  
 lambs, together  
 With their mothers, gnawing the berries of an  
 unknown plant,  
 And cries, "This is the cause of the trouble!"  
 And saying no  
 More, he at once picks the smooth fruit from  
 the heavily-laden  
 Tree, and carries it home, places it, when washed,  
 in pure  
 Water, cooking it over the fire, and fearlessly  
 drinks a large  
 Cup of it. Forthwith a warmth pervades his  
 veins, a living  
 Force is diffused through his limbs, and weariness  
 is dispelled from his aged body.  
 Then, at length, the old man exulting in the  
 blessing thus found,  
 Rejoices, and kindly shares with all his brothers.  
 They eagerly  
 At early night-fall, indulge in pleasant banquets  
 and drain great bowls.  
 No longer is it hard for them to break off sweet  
 sleep and to leave their soft beds as formerly.  
 O fortunate ones! whose hearts the sweet draught  
 has often  
 Bathed. No sluggish torpor holds their minds,  
 they briskly  
 Rise for their prescribed duties and rejoice to  
 outstrip the rays of the first light.

You also, whose care it is to feed minds with  
 divine eloquence  
 And to terrify with your words the souls of the  
 guilty, you also  
 Should indulge in the pleasant drink; for, as  
 you know, it  
 Strengthens weakness. Keen vigor is gained for  
 the limbs from  
 This source, and spreads through the whole body.  
 From this source  
 Too, shall come new strength and new power to  
 your voice.  
 You also, whom oft harmful vapors harass, whose  
 sick brain the dangerous vertigo shakes,  
 Ah, come! In this sweet liquid is a ready medi-  
 cine,  
 And none other better to calm undue agitation.  
 Apollo planted this power for himself, they say,  
 The story is worthy to be sung.

Once a disease most deadly to life assailed the disciples of Apollo's Mount. It spread far and wide, and attacked the brain itself. Already all the people of genius were suffering with this Disease; and the arts, deserted, were languishing along with The workers. Some even pretended to have the disease, and Assuming feigned suffering, gave themselves over to an idle life. Unpleasing work grew distasteful, and deadly inertia increased Everywhere. It pleased all, now released from work and labors, To indulge in care-free quiet. Apollo, full of indignation, did not endure longer that the deadly Contagion of such easy ruin should creep over them thus. And, That he might take away from seers all means of deception, he Enticed from the rich bosom of the earth this friendly plant, Than which no other is more ready either to refresh for work the Mind wearied by long studies, or to sooth troublesome sorrows of the head.

O plant, given to the human race by the gift of the Gods!  
No other out of the entire list of plants has ever vied with you.  
On your account sailors sail from our shores And fearlessly conquer the threatening winds, sandbanks and Dreadful rocks. With your nourishing growth you surpass dittany, Ambrosia, and fragrant panacea. Grim diseases flee from you. To You trusting health clings as a companion, and also the merry Crowd, conversation, amusing jokes, and sweet whisperings.

The poet Belighi toward the close of the sixteenth century composed a poem, which, freely translated, runs:

In Damascus, in Aleppo, in great Cairo,  
At every turn is to be found  
That mild fruit which gives so beloved a drink,  
Before coming to court to triumph.  
There this seditious disturber of the world,  
Has, by its unparalleled virtue,  
Supplanted all wines from this blessed day.

Jacques Delille (1738-1813) the didactic poet of nature, in *chant vi* of his "*Three Reigns of Nature*," thus apostrophizes the "divine nectar" and describes its preparation:

#### DIVINE COFFEE

*Translation from the French*

A liquid there is to the poet most dear,  
'T was lacking to Virgil, adored by Voltaire,  
'T is thou, divine coffee, for thine is the art,  
Without turning the head yet to gladden the heart.

And thus though my palate be dulled by age,  
With joy I partake of thy dear beverage.  
How glad I prepare me thy nectar most precious,  
No soul shall usurp me a rite so delicious;  
On the ambient flame when the black charcoal burns,  
The gold of thy bean to rare ebony turns,  
I alone, 'gainst the cone, wrought with fierce iron teeth,  
Make thy fruitage cry out with its bitter-sweet breath;  
Till charmed with such perfume, with care I entrust  
To the pot on my hearth the rare spice-laden dust:  
First to calm, then excite, till it seethingly whirls,  
With an eye all attention I gaze till it boils.  
At last now the liquid comes slow to repose;  
In the hot, smoking vessel its wealth I depose,  
My cup and thy nectar; from wild reeds expressed,  
America's honey my table has blest;  
All is ready; Japan's gay enamel invites—  
And the tribute of two worlds thy prestige unites:  
Come, Nectar divine, inspire thou me,  
I wish but Antigone, dessert and thee;  
For scarce have I tasted thy odorous steam,  
When quick from thy clime, soothing warmth round me stream,  
Attentive my thoughts rise and flow light as air,  
Awaking my senses and soothing my care.  
Ideas that but late moved so dull and depressed,  
Behold, they come smiling in rich garments dressed!  
Some genius awakes me, my course is begun;  
For I drink with each drop a bright ray of the sun.

Maumenet addressed to Galland the following verses:

If slumber, friend, too near, with some late glass should creep—  
Dull, poppy-perfumed sleep—  
If a too fumous wine confounds at length thy brain—  
Take coffee then—this juice divine  
Shall banish sleep and steam of vap'rous wine,  
And with its timely aid fresh vigor thou shalt find.

Castel, in his poem, *Les Plantes*, could not omit the coffee trees of the tropics. He thus addressed them in 1811:

Bright plants, the favorites of Phoebus,  
In these climes the rarest virtues offer,  
Delicious Mocha, thy sap, enchantress,  
Awakens genius, outvalues Parnasse!

In a collection of the *Songs of Brittany* in the Brest Library there are many stanzas in praise of coffee. A Breton poet has composed a little piece of ninety-six verses in which he describes the powerful attraction that coffee has for women and the possible effects on domestic happiness. The first time that coffee was used in Brittany, says an old song of that country, only the nobility drank it, and now all the common

people are using it, yet the greater part of them have not even bread.

A French poet of the eighteenth century produced the following:

#### LINES ON COFFEE

*Translation from the French*

Good coffee is more than a savory cup,  
Its aroma has power to dry liquor up.  
By coffee you get upon leaving the table  
A mind full of wisdom, thoughts lucid, nerves  
stable;

And odd tho' it be, 't is none the less true,  
Coffee's aid to digestion permits dining anew.  
And what 's very true, tho' few people know it,  
Fine coffee 's the basis of every fine poet;  
For many a writer as windy as Boreas  
Has been vastly improved by the drink ever  
glorious.

Coffee brightens the dullness of heavy philosophy,  
And opens the science of mighty geometry.  
Our law-makers, too, when the nectar imbibing,  
Plan wondrous reforms, quite beyond the de-  
scribing;

The odor of coffee they delight in inhaling,  
And promise the country to alter laws ailing.  
From the brow of the scholar coffee chases the  
wrinkles,

And mirth in his eyes like a firefly twinkles;  
And he, who before was but a hack of old Homer,  
Becomes an original, and that 's no misnomer.  
Observe the astronomer who 's straining his eyes  
In watching the planets which soar thro' the  
skies;

Alas, all those bright bodies seem hopelessly far  
Till coffee discloses his own guiding star.  
But greatest of wonders that coffee effects  
Is to aid the news-editor as he little expects;  
Coffee whispers the secrets of hidden diplomacy,  
Hints rumors of wars and of scandals so racy.  
Inspiration by coffee must be nigh unto magic,  
For it conjures up facts that are certainly tragic;  
And for a few pennies, coffee's small price per  
cup,

"Ye editor's" able to swallow the Universe up.

Esmenard celebrated Captain de Clieu's romantic voyage to Martinique with the coffee plants from the Jardin des Plantes, in some admirable verses quoted in chapter I.

Among other notable poetic flights in praise of coffee produced in France mention should be made of: "*L'Eloge du Cafe*" (Eulogy of Coffee), a song in twenty-four couplets, Paris, Jacques Estienne, 1711; "*Le Cafe*" (Coffee), a fragment from the fourth *chant* (song) of *La Grandeur de Dieu dans les merveilles de la Nature* (The Grandeur of God in the Wonders of Nature), Marseilles; "*Le Cafe*," extract from the fourth gastronomic song, by Berchoux; "*A Mon Cafe*" (To My Coffee), stanzas written by Ducis; "*Le Cafe*," anonymous stanzas inserted in the *Mace-*

*doine Poetique*, 1824; a poem in Latin in the Abbé Olivier's collection; *Le Bouquet Blanc et le Bouquet Noir, poesie en quatre chants*; *Le Cafe*, C. D. Mery, 1837; "*Eloge du Cafe*," S. Melaye, 1852.

Many Italian poets have sung the praises of coffee. L. Barotti wrote his poem, "*Il Caffé*" in 1681. Giuseppe Parini (1729-1799), Italy's great satirical and lyric poet and critic of the eighteenth century, in *Il Giorno* (*The Day*), gives a delightful pen picture of the manners and customs of Milan's polite society of the period. William Dean Howells quotes as follows from these poems (his own translation) in his *Modern Italian Poets*. The feast is over, and the lady signals to the cavalier that it is time to leave the table:

Spring to thy feet

The first of all, and, drawing near thy lady,  
Remove her chair and offer her thy hand,  
And lead her to the other room, nor suffer longer  
That the stale reek of viands shall offend  
Her delicate sense. Thee with the rest invites  
The grateful odor of the coffee, where  
It smokes upon a smaller table hid  
And graced with Indian webs. The redolent gums  
That meanwhile burn, sweeten and purify  
The heavy atmosphere, and banish thence  
All lingering traces of the feast. Ye sick  
And poor, whom misery or whom hope, perchance!  
Has guided in the noonday to these doors,  
Tumultuous, naked, and unsightly throng,  
With mutilated limbs and squalid faces,  
In litters and on crutches from afar  
Comfort yourselves, and with expanded nostrils  
Drink in the nectar of the feast divine  
That favourable zephyrs waft to you;  
But do not dare besiege these noble precincts,  
Importunately offering her that reigns  
Within your loathsome spectacle of woe!  
And now, sir, 't is your office to prepare  
The tiny cup that then shall minister,  
Slow sipped, its liquor to thy lady's lips;  
And now bethink thee whether she prefer  
The boiling beverage much or little tempered  
With sweet; or if, perchance, she likes it best,  
As doth the barbarous spouse, then when she  
sits

Upon brocades of Persia, with light fingers,  
The bearded visage of her lord caressing.

This is from "*Il Mezzogiorno*" (Noon). The other three poems, rounding out *The Day*, are "*Il Mattino*" (Morning), "*Il Vespre*" (Evening), and "*La Notte*" (Night). In "*Il Mattino*," Parini sings:  
Should dreary hypochondria's woe oppress thee,  
Should round thy charming limbs in too great  
measure  
Thy flesh increase, then with thy lips do honor  
To that clear beverage, made from the well-  
bronzed,  
The smoking, ardent beans Aleppo sends thee,  
And distant Mocha too, a thousand ship-loads;  
When slowly sipped it knows no rival.

Belli's *Il Caffè* supplies a partial bibliography of the Italian literature on coffee. There are many poems, some of them put to music. As late as 1921, there were published in Bologna some advertising verses on coffee by G. B. Zecchini with music by Cesare Cantino.

Pope Leo XIII, in his Horatian poem on "*Frugality*" composed in his eighty-eighth year, thus verses his appreciation of coffee:

Last comes the beverage of the Orient shore,  
Mocha, far off, the fragrant berries bore.  
Taste the dark fluid with a dainty lip,  
Digestion waits on pleasure as you sip.

Peter Altenberg, a Vienna poet, thus celebrated the cafés of his native city:

#### TO THE COFFEE HOUSE!

When you are worried, have trouble of one sort  
or another—to the coffee house!  
When she did not keep her appointment, for one  
reason or other—to the coffee house!  
When your shoes are torn and dilapidated—coffee  
house!  
When your income is four hundred crowns and  
you spend five hundred—coffee house!  
You are a chair warmer in some office, while  
your ambition led you to seek professional  
honors—coffee house!  
You could not find a mate to suit you—coffee  
house!  
You feel like committing suicide—coffee house!  
You hate and despise human beings, and at the  
same time you can not be happy without  
them—coffee house!  
You compose a poem which you can not inflict  
upon friends you meet in the street—coffee  
house!  
When your coal scuttle is empty, and your gas  
ration exhausted—coffee house!  
When you need money for cigarettes, you touch  
the head waiter in the—coffee house!  
When you are locked out and haven't the money  
to pay for unlocking the house door—coffee  
house!  
When you acquire a new flame, and intend  
revoking the old one, you take the new one  
to the old one's—coffee house!  
When you feel like hiding you dive into a—  
coffee house!  
When you want to be seen in a new suit—coffee  
house!  
When you can not get anything on trust any-  
where else—coffee house!

English poets from Milton to Keats celebrated coffee. Milton (1608-1674) in his "*Comus*" thus acclaimed the beverage:

One sip of this  
Will bathe the drooping spirits in delight  
Beyond the bliss of dreams.

Alexander Pope, poet and satirist (1688-1744), has the oft-quoted lines:

Coffee which makes the politician wise,  
And see through all things with his half-shut eyes.

In Carruthers' *Life of Pope*, we read that this poet inhaled the steam of coffee in order to obtain relief from the headaches to which he was subject. We can well understand the inspiration which called forth from him the following lines when he was not yet twenty:

As long as Mocha's happy tree shall grow,  
While berries crackle, or while mills shall go;  
While smoking streams from silver spouts shall  
glide,  
Or China's earth receive the sable tide,  
While coffee shall to British nymphs be dear,  
While fragrant steams the bended head shall  
cheer,  
Or grateful bitters shall delight the taste,  
So long her honors, name and praise shall last.

Pope's famous *Rape of the Lock* grew out of coffee-house gossip. The poem contains the passage on coffee already quoted:

For lo! the board with cups and spoons is  
crowned;  
The berries crackle and the mill turns round;  
On shining altars of japan they raise  
The silver lamp: the fiery spirits blaze:  
From silver spouts the grateful liquors glide,  
While China's earth receives the smoking tide.  
At once they gratify their scent and taste,  
And frequent cups prolong the rich repast.  
Straight hover round the fair her airy band;  
Some, as she sipped, the fuming liquor fanned:  
Some o'er her lap their careful plumes displayed,  
Trembling, and conscious of the rich brocade.  
Coffee (which makes the politician wise,  
And see through all things with his half-shut  
eyes.)  
Sent up in vapors to the baron's brain  
New stratagems, the radiant lock to gain.

Pope often broke the slumbers of his servant at night by calling him to prepare a cup of coffee; but for regular serving, it was his custom to grind and prepare it upon the table.

William Cowper's fine tribute to "the cups that cheer but not inebriate," a phrase which he is said to have borrowed from Bishop Berkeley, was addressed to tea and not to coffee, to which it has not infrequently been wrongfully attributed. It is taken from one of the most pleasing pictures in *The Task*.

Cowper refers to coffee but once in his writings. In his *Pity for Poor Africans* he expresses himself as "shocked at the ignorance of slaves":

I pity them greatly, but I must be mum  
For how could we do without sugar and rum?  
Especially sugar, so needful we see;  
What! Give up our desserts, our coffee and tea?

thus contenting himself, like many others, with words of pity where more active pro-

test might sacrifice his personal ease and comfort.

Leigh Hunt (1784-1859), and John Keats (1795-1834), were worshippers at the shrine of coffee; while Charles Lamb, famous poet, essayist, humorist, and critic, has celebrated in verse the exploit of Captain de Clieu in the following delightful verses:

#### THE COFFEE SLIPS

Whene'er I fragrant coffee drink,  
I on the generous Frenchman think,  
Whose noble perseverance bore  
The tree to Martinico's shore.  
While yet her colony was new,  
Her island products but a few;  
Two shoots from off a coffee tree  
He carried with him o'er the sea.  
Each little tender coffee slip  
He waters daily in the ship.  
And as he tends his embryo trees,  
Feels he is raising 'midst the seas  
Coffee groves, whose ample shade  
Shall screen the dark Creolian maid.  
But soon, alas! His darling pleasure  
In watching this his precious treasure  
Is like to fade—for water fails  
On board the ship in which he sails.  
Now all the reservoirs are shut,  
The crew on short allowance put;  
So small a drop is each man's share,  
Few leavings you may think there are  
To water these poor coffee plants—  
But he supplies their grasping wants,  
Even from his own dry parched lips  
He spares it for his coffee slips.  
Water he gives his nurslings first,  
Ere he allays his own deep thirst,  
Lest, if he first the water sip,  
He bear too far his eager lip.  
He sees them droop for want of more;  
Yet when they reach the destined shore,  
With pride the heroic gardener sees  
A living sap still in his trees.  
The islanders his praise resound;  
Coffee plantations rise around;  
And Martinico loads her ships  
With produce from those dear-saved slips.

In John Keat's amusing fantasy, *Cap and Bells*, the Emperor Elfinan greets Hum, the great soothsayer, and offers him refreshment:

"You may have sherry in silver, hock in gold,  
or glass'd champagne  
. . . what cup will you drain?"  
"Commander of the Faithful!" answered Hum,  
"In preference to these, I'll merely taste  
A thimble-full of old Jamaica rum."  
"A simple boon," said Elfinan; "thou mayst  
Have Nantz, with which my morning coffee's  
laced."

But Hum accepts the glass of Nantz, without the coffee, "made racy with the

third part of the least drop of *crème de citron*, crystal clear."

Numerous broadsides printed in London, 1660 to 1675, have been referred to in chapter IX. Few of them possess real literary merit.

"Coffee and Crumpets" has been much quoted. It was published in *Fraser's Magazine*, in 1837. Its author calls himself "Launcelot Littledo." The poem is quite long, and only those portions are printed here that refer particularly to "Yemen's fragrant berry":

#### COFFEE AND CRUMPETS

By Launcelot Littledo of Pump Court, Temple,  
Barrister-at-law.

There's ten o'clock! From Hampstead to the  
Tower  
The bells are chanting forth a lusty carol;  
Wrangling, with iron tongues, about the hour,  
Like fifty drunken fishwives at a quarrel;  
Cautious policemen shun the coming shower;  
Thompson and Fearon tap another barrel;  
"Dissolve frigus, lignum super foco.  
*Large reponens.*" Now, come Orinoco!

To puff away an hour, and drink a cup,  
A brimming *breakfast-cup* of ruddy Mocha—  
Clear, luscious, dark, like eyes that lighten up  
The raven hair, fair cheek, and *bella boca*  
Of Florence maidens. I can never sup  
Of perigourd, but (*quai a chi la tocca!*)  
I'm doomed to indigestion. So to settle  
This strife eternal,—Betty, bring the kettle!

Coffee! oh, Coffee! Faith, it is surprising.  
'Mid all the poets, good, and bad, and worse,  
Who've scribbled (Hock or Chian eulogizing)  
Post and papyrus with "immortal verse"—  
Melodiously similitudinising  
In Sapphics languid or Alcaics terse  
No one, my little brown Arabian berry,  
Hath sung thy praises—'tis surprising! very!

Were I a poet now, whose ready rhymes,  
Like Tommy Moore's, came tripping to their  
places—  
Reeling along a merry troll of chimes,  
With careless truth,—a dance of fuddled Graces;  
Hear it—*Gazette, Post, Herald, Standard, Times*,  
I'd write an epic! Coffee for its basis;  
Sweet as e'er warbled forth from cockney  
throttles  
Since Bob Montgomery's or Amos Cottle's.

Thou sleepy-eyed Chinese—enticing siren,  
Pekoe! the Muse hath said in praise of thee,  
"That cheers but not inebriates"; and Byron  
Hath called thy sister "Queen of Tears," Bohea!  
And he, Anacreon of Rome's age of iron,  
Says, how untruly "*Quis non potius te.*"  
While coffee, thou—bill-plastered gables say,

Art like old Cupid, "roasted every day."  
I love, upon a rainy night, as this is,  
When rarely and more rare the coaches rattle  
From street to street, to sip thy fragrant kisses;



While from the Strand remote some drunken  
battle  
Far-faintly echoes, and the kettle hisses  
Upon the glowing hob. No tittle-tattle  
To make a single thought of mine an alien  
From thee, my coffee-pot, my fount Castalian.

The many intervening verses cover an unhappy termination to an otherwise delightful ball. He is sitting with his charming "Mary," about to ask her to be his bride, when the unfortunate overturning of a glass of red wine into her white satin gown, at the same time overthrows all his dreams of bliss, "for the shrew displaces the angel he adored," and he resigns himself to the life of "a man in chambers."

'Tis thus I sit and sip, and sip and think,  
And think and sip again, and dip in *Fraser*,  
A health, King Oliver! to thee I drink:  
Long may the public have thee to amaze her.  
Like *Figaro*, thou makest one's eyelids wink,  
Twirling on practised palm thy polished razor—  
True Horace temper, smoothed on attic strop;  
Ah! thou couldst "*faire la barbe a tout l'Europe*."

Come, Oliver, and tell us what the news is;  
An easy chair awaits thee—come and fill 't.  
Come, I invoke thee, as they do the muses,  
And thou shalt choose thy tippie as thou wilt.  
And if thy lips my sober cup refuses,  
For ruddier drops the purple grape has spilt,  
We can sing, sipping in alternate verses,  
Thy drink and mine, like Corydon and Thyrsis.

Fill the bowl, but not with wine,  
Potent port, or fiery sherry;  
For this milder cup of mine  
Crush me Yemen's fragrant berry.

Gentle is the grape's deep cluster,  
But the wine's a wayward child;  
Nectar *this!* of meeker lustre—  
*This* the cup that "draws it mild."  
Deeply drink its streams divine—  
Fill the cup, but not with wine.

Prior and Montague inserted the following poetic vignette in their *City Mouse and Country Mouse*, written in burlesque of Dryden's *Hind and Panther*:

Then on they jogg'd; and since an hour of talk  
Might cut a banter on the tedious walk,  
As I remember, said the sober mouse,  
I've heard much talk of the Wits' Coffee-house;  
Thither, says Brindle, thou shalt go and see  
Priests supping coffee, sparks and poets tea;  
Here rugged frieze, there quality well drest,  
These baffling the grand Senior, those the Test,  
And there shrewd guesses made, and reasons  
given,  
That human laws were never made in heaven;  
But, above all, what shall oblige thy sight,  
And fill thy eyeballs with a vast delight,  
Is the poetic judge of sacred wit,  
Who does i' th' darkness of his glory sit;  
And as the moon who first receives the light,

With which she makes these nether regions  
bright,  
So does he shine, reflecting from afar  
The rays he borrowed from a better star;  
For rules, which from Corneille and Racin flow,  
Admired by all the scribbling herd below,  
From French tradition while he does dispense  
Unerring truths, 't is schism, a damned offense,  
To question his, or trust your private sense.

The late Geoffrey Sephton, an English poet and novelist, many years resident in Vienna, whose fantastic stories and fairy tales are well known in Europe, wrote the following sonnets on coffee:

### TO THE MIGHTY MONARCH, KING KAUHEE<sup>1</sup>

By Geoffrey Sephton

#### I

Away with opiates! Tantalising snares  
To dull the brain with phantoms that are not.  
Let no such drugs the subtle senses rot  
With visions stealing softly unawares  
Into the chambers of the soul. Nightmares  
Ride in their wake, the spirits to besot.  
Seek surer means to banish haunting cares:  
Place on the board the steaming Coffee-pot!  
O'er luscious fruit, dessert and sparkling flask,  
Let proudly rule as King the Great Kauhee,  
For he gives joy divine to all that ask,  
Together with his spouse, sweet *Eau de Vie*.  
Oh, let us 'neath his sovran pleasure bask.  
Come, raise the fragrant cup and bend the knee!

#### II

O great Kauhee, thou democratic Lord,  
Born 'neath the tropic sun and bronzed to splendour  
In lands of Wealth and Wisdom, who can render  
Such service to the wandering Human Horde  
As thou at every proud or humble board?  
Beside the honest workman's homely fender,  
'Mid dainty dames and damsels sweetly tender,  
In china, gold and silver, have we poured  
Thy praise and sweetness, Oriental King.  
Oh, how we love to hear the kettle sing  
In joy at thy approach, embodying  
The bitter, sweet and creamy sides of life;  
Friend of the People, Enemy of Strife,  
Sons of the Earth have born thee labouring.

In America, too, poets have sung in praise of coffee. The somewhat doubtful "kind that mother used to make" is celebrated in James Whitcomb Riley's classic poem:

### LIKE HIS MOTHER USED TO MAKE<sup>2</sup>

"*Uncle Jake's Place*," *St. Jo., Mo.*, 1874.

"I was born in Indiany," says a stranger, lank  
and slim,  
As us fellers in the restaurant was kindo' guyin'  
him,

<sup>1</sup> Kauhee (or *kahve*) is Turkish for coffee.

<sup>2</sup> Copyright, 1913. Used by special permission of the publishers, the Bobbs-Merrill Co., Indianapolis, Ind.

And Uncle Jake was slidin' him another punkin  
 pie  
 And a' extry cup o' coffee, with a twinkle in  
 his eye—  
 "I was born in Indiany—more'n forty years ago—  
 And I hain't ben back in twenty—and I'm work-  
 in' back'ards slow;  
 But I've et in ever' restarunt twixt here and  
 Santy Fee,  
 And I want to state this coffee tastes like gittin'  
 home, to me!  
 "Pour us out another, Daddy," says the feller,  
 warmin' up,  
 A-speakin' crost a saucerful, as Uncle tuk his  
 cup—  
 "When I see yer sign out yander," he went on,  
 to Uncle Jake—  
 "'Come in and git some coffee like yer mother  
 used to make'—  
 I thought of *my* old mother, and the Posey  
 county farm,  
 And me a little kid again, a-hangin' in her arm,  
 As she set the pot a-bilin', broke the eggs and  
 poured 'em in"—  
 And the feller kindo' halted, with a trimble in  
 his chin;  
 And Uncle Jake he fetched the feller's coffee  
 back, and stood  
 As solemn, fer a minute, as a' undertaker would;  
 Then he sorto' turned and tiptoed to'rds the  
 kitchen door—and next,  
 Here comes his old wife out with him, a-rubbin'  
 of her specs—  
 And she rushes fer the stranger, and she hollers  
 out, "It's him!  
 Thank God we've met him comin'!—Don't you  
 know yer mother, Jim?"  
 And the feller, as he grabbed her, says,—  
 "You bet I hain't forgot—  
 But," wipin' of his eyes, says he, "yer coffee's  
 mighty hot!"

One of the most delightful coffee poems  
 in English is Francis Saltus Saltus' (d.  
 1889) sonnet on "the voluptuous berry,"  
 as found in *Flasks and Flavons*:

#### COFFEE

Voluptuous berry! Where may mortals find  
 Nectars divine that can with thee compare,  
 When, having dined, we sip thy essence rare,  
 And feel towards wit and repartee inclined?

Thou wert of sneering, cynical Voltaire,  
 The only friend; thy power urged Balzac's mind  
 To glorious effort; surely Heaven designed  
 Thy devotees superior joys to share.  
 Whene'er I breathe thy fumes, 'mid Summer stars,

The Orient's splendent pomps my vision greet.  
 Damascus, with its myriad minarets, gleams!  
 I see thee, smoking, in immense bazaars,  
 Or yet, in dim seraglios, at the feet  
 Of blond Sultanas, pale with amorous dreams!

Arthur Gray, in *Over the Black Coffee*  
 (1902), has made the following contribu-  
 tion to the poetry of coffee, with an unfor-  
 tunate reflection on tea, which might well  
 have been omitted:

#### COFFEE

O, boiling, bubbling, berry, bean!  
 Thou consort of the kitchen queen—  
 Brownd and ground of every feature,  
 The only aromatic creature,  
 For which we long, for which we feel,  
 The breath of morn, the perfumed meal.  
 For what is tea? It can but mean,  
 Merely the mildest go-between.  
 Inspid sobriety of thought and mind  
 It "cuts no figure"—we can find—  
 Save peaceful essays, gentle walks,  
 Purring cats, old ladies' talks—  
 \* \* \*

But coffee! can other tales unfold.  
 Its history's written round and bold—  
 Brave buccaneers upon the "Spanish Main,"  
 The army's march across the length'ning plain,  
 The lone prospector wandering o'er the hill,  
 The hunter's camp, thy fragrance all distill.  
 So here's a health to coffee! Coffee hot!  
 A morning toast! Bring on another pot.

*The Tea and Coffee Trade Journal* pub-  
 lished in 1909 the following excellent stan-  
 zas by William A. Price:

#### AN ODE TO COFFEE

Oh, thou most fragrant, aromatic joy, impugned,  
 abused, and often stormed against,  
 And yet containing all the blissfulness that in  
 a tiny cup could be condensed!  
 Give thy contemners calm, imperial scorn—  
 For thou wilt reign through ages yet unborn!

Some ancient Arab, so the legend tells, first  
 found thee—may his memory be blest!  
 The worldwide sign of brotherhood today, the  
 binding tie between the East and West!  
 Good coffee pleases in a Persian dell,  
 And Blackfeet Indians make it more than well.

The lonely traveler in the desert range, if thou  
 art with him, smiles at eventide—  
 The sailor, as thy perfume bubbles forth, laughs  
 at the ocean as it rages wide—  
 And where the camps of fighting men are found  
 Thy fragrance hovers o'er each battleground.

"Use, not abuse, the good things of this life"—  
 that is a motto from the Prophet's days,  
 And, dealing with thee thus, we ne'er shall come  
 to troublous times or parting of the ways.  
 Comfort and solace both endure with thee,  
 Rich, royal berry of the coffee tree!

The *New York Tribune* published in  
 1915 the following lines by Louis Unter-  
 meyer, which was subsequently included  
 in his — *and Other Poets*.<sup>3</sup>

#### GILBERT K. CHESTERTON RISES TO THE TOAST OF COFFEE

Strong wine it is a mocker; strong wine it is a  
 beast.  
 It grips you when it starts to rise; it is the  
 Fabled Yeast.

<sup>3</sup> Copyright, 1916, by Henry Holt & Co., New York.  
 Reprinted by permission.

You should not offer ale or beer from hops that  
are freshly picked,  
Nor even Benedictine to tempt a benedict.  
For wine has a spell like the lure of hell, and  
the devil has mixed the brew;  
And the friends of ale are a sort of pale and  
weary, witless crew—  
And the taste of beer is a sort of a queer and  
undecided brown—  
But, comrades, I give you coffee—drink it up,  
drink it down.  
With a fol-de-rol-dol and a fol-de-rol-dee, etc.  
Oh, cocoa's the drink for an elderly don who  
lives with an elderly niece;  
And tea is the drink for studios and loud and  
violent peace—  
And brandy's the drink that spoils the clothes  
when the bottle breaks in the trunk;  
But coffee's the drink that is drunken by men  
who will never be drunk.  
So, gentlemen, up with the festive cup, where  
Mocha and Java unite;  
It clears the head when things are said too  
brilliant to be bright!  
It keeps the stars from the golden bars and the  
lips of the tipsy town;  
So, here's to strong, black coffee—drink it up,  
drink it down!  
With a fol-de-rol-dol and a fol-de-rol-dee, etc.

The American breakfast cup was celebrated in up-to-date American style in the following by Helen Rowland in the *New York Evening World*:

#### WHAT EVERY WIFE KNOWS

Give me a man who drinks good, hot, dark, strong  
coffee for breakfast!  
A man who smokes a good, dark, fat cigar after  
dinner!  
You may marry your milk-faddist, or your anti-  
coffee crank, as you will!  
But I know the magic of the coffee pot!  
Let me make my Husband's coffee—and I care  
not who makes eyes at him!  
Give me two matches a day—  
One to start the coffee with, at breakfast, and  
one for his cigar, after dinner!  
And I defy all the houris in Christendom to  
light a new flame in his heart!  
Oh, sweet supernal coffee-pot!  
Gentle panacea of domestic troubles,  
Faithful author of that sweet nepenthe which  
deadens all the ills that married folks are  
heir to.  
Cheery, glittering, soul-soothing, warmed hearted,  
inanimate friend!  
What wife can fail to admit the peace and  
serenity she owes to *you*?  
To you, who stand between her and all her early  
morning troubles—  
Between her and the before-breakfast grouch—  
Between her and the morning-after headache—  
Between her and the cold-gray-dawn scrutiny?  
To you, who supply the golden nectar that stim-  
ulates the jaded masculine soul,  
Soothes the shaky masculine nerves, stirs the  
fagged masculine mind, inspires the slow  
masculine sentiment,

And starts the sluggish blood a-flowing and the  
whole day right!

What is it, I ask you, when he comes down to  
breakfast dry of mouth, and touchy of tem-  
per—

That gives him pause, and silences that scin-  
tillating barb of sarcasm on the tip of his  
tongue,

With which he meant to impale you?

It is the sweet aroma of the coffee-pot—the thrill-  
ing thought of that first delicious sip!

What is it, on the morning after the club dance,  
That hides your weary, little, washed-out face  
and straggling, uncurled coiffure from his  
critical eyes?

It is the generous coffee-pot, standing like a  
guardian angel between you and him!

And in those many vital psychological moments,  
during the honeymoon, which decide for or  
against the romance and happiness of all the  
rest of married life—

Those critical before-breakfast moments when  
temperament meets temperament, and will  
meets "won't"—

What is it that halts you on the brink of tragedy,  
And distracts you from the temptation to answer  
back?

It is the absorbing anxiety of watching the coffee  
boil!

What is it that warms his veins and soothes your  
nerves,

And turns all the world suddenly from a dismal  
gray vale of disappointment to a bright rosy  
garden of hope—

And starts *another* day gliding smoothly along  
like a new motor car?

What is it that will do more to transform a man  
from a fiend into an angel than baptism in  
the River Jordan?

*It is the first cup of coffee in the morning!*

Berton Braley, American poet, in 1935,  
celebrates the first cup of coffee in the  
morning, in the following poem:

#### GROUNDS FOR COMPLAINT

I've a stomach made of zinc which will handle  
food and drink

That would cause an ostrich worry and com-  
punction;

Breakfast, dinner, tea or lunch—anything a goat  
would munch—

I can savor and assimilate with unction.

Jellies prettified with dyes, armor-plated cakes  
and pies

Which would knock a buzzard flat without a  
warning

I can merrily digest with a gustatory zest  
—If my coffee's only decent in the morning.

I'm a very cheerful gent with a heart resilient  
And a view of life as bright as I can make it,  
And if fortune, with a frown, stands me up and  
slaps me down

I have proven in the past that I can take it.

I can even rise above discombobulated love

I can stand a lady's sublimated scorning,

But I'm totally inutile and my whole career is  
futile

If I don't get decent coffee in the morning.

Merrily I roll along without women, wine or song,  
 I can do without companionship or money;  
 Lacking pictures, books or plays, I can worry  
 through my days  
 With a diposition moderately sunny.  
 I'm the captain of my soul, independent—on the  
 whole—  
 But my freedom and my courage die a-borning  
 And I wander in a coma if I miss the fresh aroma  
 Of a fragrant cup of coffee in the morning!<sup>4</sup>

#### *Coffee in Dramatic Literature*

Coffee was first "dramatized," so to speak, in England, where we read that Charles II and the Duke of York attended the first performance of *Tarugo's Wives or the Coffee House*, a comedy, in 1667, which Samuel Pepys described as "the most ridiculous and insipid play I ever saw in my life." The author was Thomas St. Serf. The piece opens in a lively manner, with a request on the part of its fashionable hero for a change of clothes. Accordingly, Tarugo puts off his "vest, hat, perriwig, and sword," and serves the guests to coffee, while the apprentice acts his part as a gentleman customer. Presently other "customers of all trades and professions" come dropping into the coffee house. These are not always polite to the supposed coffee-man; one complains of his coffee being "nothing but warm water boyl'd with burnt beans," while another desires him to "bring chocolette that's prepar'd with water, for I hate that which is encouraged with eggs." The pedantry and nonsense uttered by a "schollar" character is, perhaps, an unfair specimen of coffee-house talk; it is especially to be noticed that none of the guests ventures upon the dangerous ground of politics.

In the end, the coffee-master grows tired of his clownish visitors, saying plainly, "This rudeness becomes a suburb tavern rather than my coffee house"; and with the assistance of his servants he "thrusts 'em all out of doors, after the schollars and customers pay."

In 1694, there was published Jean Baptiste Rousseau's comedy, *Le Caffé*, which appears to have been acted only once in Paris, although a later English dramatist says it met with great applause in the French capital. *Le Caffé* was written in Laurent's café, which was frequented by Fontenelle, Houdard de la Motte, Dauchet, the abbé Alary Boindin, and others. Voltaire said

<sup>4</sup> *New York American*, April 16, 1935. Copyright. By permission.

that "this work of a young man without any experience either of the world of letters or of the theater seems to herald a new genius."

About this time it was the fashion for the coffee-house keepers of Paris, and the waiters, to wear Armenian costumes; for Pascal had builded better than he knew. In *La Foire Saint-Germain*, a comedy by Dancourt, played in 1696, one of the principal characters is old "Lorange, a coffee merchant clothed as an Armenian." In scene 5, he says to Mlle. Mousset, "a seller of house dresses," that he has been "a naturalized Armenian for three weeks."

Mrs. Susannah Centlivre (1667-1723), in her comedy, *A Bold Stroke for a Wife*, produced about 1719, has a scene laid in Jonathan's coffee house about that period. While the stock jobbers are talking in the first scene of Act II, the coffee boys are crying, "Fresh Coffee, gentlemen, fresh coffee? . . . Bohea tea, gentlemen?"

Henry Fielding (1707-1754) published *The Coffee-House Politician, or Justice caught in his own trap*, a comedy, in 1730.

*The Coffee House, a dramattick Piece by James Miller*, was performed at the Theater Royal in Drury Lane in 1737. The interior of Dick's coffee house figured as an engraved frontispiece to the published version of the play.

The author states in the preface that "this piece is partly taken from a comedy of one act written many years ago in French by the famous Rosseau, called 'Le Caffé,' which met with great applause in Paris." The coffee house in the play is conducted by the Widow Notable, who has a pretty daughter for whom, like all good mothers, she is anxious to arrange a suitable marriage.

In the first scene, an acrimonious conversation takes place between Puzzle, the Politician, and Bays, the poet, in which squabble the Pert Beau and the Solemn Beau, and other habitués of the place take part. Puzzle discovers that a comedian and other players are in the room, and insists that they be ejected or forbidden the house. The Widow is justly incensed, and indignantly replies:

Forbid the Players my House, Sir! Why, Sir, I get more by them in a Week than I do by you in seven Years. You come here and hold a paper in your hand for an Hour, disturb the whole Company with your Politics, call for Pen and Ink, Paper and Wax, beg a Pipe of Tobacco, burn out half a Candle, eat half a Pound of

Sugar, and then go away, and pay Two-pence for a Dish of Coffee. I could soon shut up my doors if I had not some other good People to make amends for what I lose by such as you, Sir.

All join the Widow in scoffing and jeering, and exit the highly discomfited Puzzle. The pretty little Kitty tricks her mother with the aid of the Player, and marries the man of her choice, but is forgiven when he is found to be a gentleman of the Temple.

The play is in one act and has several songs. The last is one of five stanzas, with music "set by Mr. Caret":

## SONG

What Pleasures a Coffee-House daily bestows!  
To read and hear how the World merrily goes;  
To laugh, sing and prattle of This, That, and  
T' other;  
And be flatter'd and ogl'd and kiss'd too, like  
Mother.  
Here the Rake, after Roving and Tipling all  
Night,  
For his Groat in the Morning may set his Head  
right,  
And the Beau, who ne'er fouls his White fingers  
with Brass,  
May have his Sixpen' worth of—Stare in the  
Glass.  
The Doctor, who'd always be ready to kill,  
May ev'ry Day here take his Stand, if he will;  
And the soldier, who'd bluster and challenge  
secure,  
May draw boldly here, for—we'll hold him he's  
sure.  
The Lawyer, who's always in quest of his Prey,  
May find fools here to feed upon every Day;  
And the sage Politician, in Coffee-Grounds known,  
May point out the Fate of each Crown but—his  
own.  
Then, Gallants, since ev'rything here you may  
find  
That pleasures the Fancy or profits the Mind,  
Come all, and take each a full Dish of Delight,  
And crowd up our Coffee-House every night.

John Timbs tells us this play "met with great opposition on its representation, owing to its being stated that the characters were intended for a particular family (that of Mrs. Yarrow and her daughter) who kept Dick's, the coffee-house which the artist had inadvertently selected as the frontispiece. It appears," Timbs continues, "that the landlady and her daughter were the reigning toast of the Templars, who then frequented Dick's; and took the matter up so strongly that they united to condemn the farce on the night of its production; they succeeded, and even extended their resentment to everything suspected to be this author's (the Rev. James Miller) for a considerable time after."

## SONG.

Set by Mr. CARET.



*What Pleasures a Coffee-House daily bestows!  
To read and hear how the World merrily goes;  
To laugh, sing, and prattle of This, That, and T'other;  
And be flatter'd, and ogl'd, and kiss'd too, like Mother.*

SONG FROM "THE COFFEE HOUSE"

Here

Carlo Goldoni, who has been called the Molière of Italy, wrote *La Bottega di Caffè*, (The Coffee House), a naturalistic comedy of bourgeois Venice, satirizing scandal and gambling, in 1750. The scene is a Venetian coffee house, probably Florian's, where several actions take place simultaneously. Among many remarkable studies is one of a prattling slanderer, Don Marzio, which ranks as one of the finest bits of original character drawing the stage has ever seen. The play was produced in English by the Chicago Theatre Society in 1912. Chatfield-Taylor thinks Voltaire probably imitated *La Bottega di Caffè* in his *Le Café, ou l'Écossaise*. Goldoni was a lover of coffee, a regular frequenter of the coffee houses of his time, from which he drew much in the way of inspiration,<sup>5</sup> Pietro Longhi, called the Venetian Hogarth, in one of his pictures presenting life and manners in Venice during the years of her decadence, shows Goldoni as a visitor in a café of the period, with a female mendicant soliciting alms. It is in the collection of Professor Italic Brass.

Goldoni, in the comedy *The Persian Wife*, gives us a glimpse of coffee making in the middle of the eighteenth century. He puts these words into the mouth of Curcuma, the slave:

Here is the coffee, ladies, coffee native of  
Arabia,  
And carried by the caravans into Ispahan.  
The coffee of Arabia is certainly always the  
best.

<sup>5</sup> Chatfield-Taylor, H. C. *Goldoni*. New York, 1913 (p. 607).



While putting forth its leaves on one side, upon  
the other the flowers appear;  
Born of a rich soil, it wishes shade, or but  
little sun.  
Planted every three years is this little tree in  
the surface of the soil.  
The fruit, though truly very small,  
Should yet grow large enough to become some-  
what green.  
Later, when used, it should be freshly ground,  
Kept in a warm and dry place and jealously  
guarded.

\* \* \*

But a small quantity is needed to prepare it.  
Put in the desired quantity and do not spill it  
over the fire:  
Heat it till the foam rises, then let it subside  
again away from the fire;  
Do this seven times at least, and coffee is made  
in a moment.

In 1760 there appeared in France *Le Café, ou l'Écossaise, comédie*, which purported to have been written by a Mr. Hume, an Englishman, and to have been translated into French. It was in reality the work of Voltaire, who had brought out another play, *Socrates*, in the same manner a short time before. *Le Café*, was translated into English the same year under the title *The Coffee House, or Fair Fugitive*. The title page says the play is written by "Mr. Voltaire" and translated from the French. It is a comedy in five acts. The principal characters are: Fabrice, a good-natured man and the keeper of the coffee house; Constantia, the fair fugitive; Sir William Woodville, a gentleman of distinction under misfortune; Belmont, in love with Constantia, a man of fortune and interest; Freeport, a merchant and an epitome of English manners; Scandal, a sharper; and Lady Alton, in love with Belmont.

*Il Caffè di Campagna*, a play with music by Galuppi, appeared in Italy in 1762.

Another Italian play, a comedy called *La Caffettiéra da Spirito* was produced in 1807.

*Hamilton*, a play by Mary P. Hamlin and George Arliss, the latter also playing the title rôle, was produced in America by George C. Tyler in 1918. The first-act scene is laid in the Exchange coffee house of Philadelphia, during the period of Washington's first administration. Among the characters introduced in this scene are James Monroe, Count Tallyrand, General Philip Schuyler, and Thomas Jefferson.

The authors very faithfully reproduce the atmosphere of the coffee house of Washington's time. Tallyrand remarks "Everybody comes to see everybody at the Ex-

change Coffee House It is club, restaurant, merchants' exchange, everything."

*The Autocrat of the Coffee Stall*, a play in one act, by Harold Chapin, was published in New York in 1921.

#### *Coffee and Literature in General*

An interesting book might be written on the transformation that tea and coffee have wrought in the tastes of famous literary men. And of the two stimulants, coffee seems to have furnished greater refreshment and inspiration to most. However, both beverages have made civilization their debtor in that they weaned so many fine minds from the heavy wines and spirits in which they once indulged.

Voltaire and Balzac were the most ardent devotees of coffee among the French *litterati*. Sir James Mackintosh (1765-1832), the Scottish philosopher and statesman, was so fond of coffee that he used to assert that the powers of a man's mind would generally be found to be proportional to the quantity of that stimulant which he drank. His brilliant schoolmate and friend, Robert Hall (1764-1831), the Baptist minister and pulpit orator, preferred tea, of which he sometimes drank a dozen cups. Cowper, Parson and Parr, the famous Greek scholars; Dr. Samuel Johnson; and William Hazlitt, the writer and critic, were great tea drinkers; but Burton, Dean Swift, Addison, Steele, Leigh Hunt, and many others, celebrated coffee.

Dr. Charles B. Reed, professor in the medical school of Northwestern University, says that coffee may be considered as a type of substance that fosters genius. History seems to bear him out. Coffee's essential qualities are so well defined, says Dr. Reed, that one critic has claimed the ability to trace throughout the works of Voltaire those portions that came from coffee's inspiration. Tea and coffee promote a harmony of the creative faculties that permits the mental concentration necessary to produce the masterpieces of art and literature.

Voltaire (1694-1778) the king of wits, was also king of coffee drinkers. Even in his old age he was said to have consumed fifty cups daily. To the abstemious Balzac (1799-1850) coffee was both food and drink.

In Frederick Lawton's *Balzac* we read: "Balzac worked hard. His habit was to go

to bed at six in the evening, sleep till twelve, and, after, to rise and write for nearly twelve hours at a stretch, imbibing coffee as a stimulant through these spells of composition."

In his *Treatise on Modern Stimulants*, Balzac thus describes his reaction to his most beloved stimulant:

This coffee falls into your stomach, and straightway there is a general commotion. Ideas begin to move like the battalions of the Grand Army on the battlefield, and the battle takes place. Things remembered arrive at full gallop, ensign to the wind. The light cavalry of comparisons deliver a magnificent deploying charge, the artillery of logic hurry up with their train and ammunition, the shafts of wit start up like sharpshooters. Similes arise, the paper is covered with ink; for the struggle commences and is concluded with torrents of black water, just as a battle with powder.

When Balzac tells how Doctor Minoret, Ursule Minoret's guardian, used to regale his friends with a cup of "Moka," mixed with Bourbon and Martinique, which the Doctor insisted on personally preparing in a silver coffee pot, it is his own custom that he is detailing. His Bourbon he bought only in the rue Mont Blanc (now the chaussé d'Antin); the Martinique, in the rue des Vieilles Audriettes; the Mocha, at a grocer's in the rue de l'Université. It was half a day's journey to fetch them.

There have been notable contributions to the general literature of coffee by French, Italian, English, and American writers. Space does not permit of more than passing mention of some of them.

The writings of the early French and English *literati* on coffee have been touched upon in the chapters on the coffee houses of old London and the early Parisian coffee houses, and in the history chapters dealing with the evolution of coffee drinking and coffee manners and customs.

After Dufour, Galland, and La Roque in France, there were Count Rumford, John Timbs, Douglas Ellis, and Robinson in England; Jardin and Franklin in France; Belli in Italy; Hewitt, Thurber, and Walsh in America.

Mention has been made of coffee references in the works of Aubrey, Burton, Addison, Steele, Bacon, and D'Israeli.

Brillat-Savarin (1755-1826), the great French epicure, knew coffee as few men before him or since. In his historical elegy, contained in *Gastronomy as a Fine Art, or the Science of Good Living*, he exclaims:

You crossed and mitred abbots and bishops who dispensed the favors of Heaven, and you the dreaded templars who armed yourselves for the extermination of the Saracens, you knew nothing of the sweet restoring influence of our modern chocolate, nor of the thought-inspiring bean of Arabia—how I pity you!

O. de Gourcuff's *De la Café, épître attribué à Senecé*, is deserving of honorable mention.

An early French writer pays this tribute to the inspirational effects of coffee:

It is a beverage eminently agreeable, inspiring and wholesome. It is at once a stimulant, a cephalic, a febrifuge, a digestive, and an anti-soporific; it chases away sleep, which is the enemy of labor; it invokes the imagination, without which there can be no happy inspiration. It expels the gout, that enemy of pleasure, although to pleasure gout owes its birth; it facilitates digestion, without which there can be no true happiness. It disposes to gaiety, without which there is neither pleasure nor enjoyment; it gives wit to those who already have it, and it even provides wit (for some hours at least) to those who usually have it not. Thank heaven for Coffee, for see how many blessings are concentrated in the infusion of a small berry. What other beverage in the world can compare with it? Coffee, at once a pleasure and a medicine; Coffee, which nourishes at the same moment the mind, body and imagination. Hail to thee! Inspirer of men of letters, best digestive of the gourmand. Nectar of all men.

In Bologna, 1691, Angelo Rambaldi published *Ambrosia arabica, caffè discorso*. This work is divided into eighteen sections, and describes the origin, cultivation, and roasting of the bean, as well as telling how to prepare the beverage.

During the time that Milan was under Spanish rule, Cesare Beccaria directed and edited a publication entitled *Il Caffè*, which was published from June 4, 1764, to May, 1766, "edited in Brescia by Giammaria Rizzardi and undertaken by a little society of friends," according to the salutatory. Besides the Marchese Beccaria, other editors and contributors were Pietro and Alexander Verri, Baillon, Visconti, Colpani, Longhi, Albertenghi, Frisi, and Secchi. The same periodical, with the same editorial staff, was published also in Venice in the *Typografia Pizzolato*.

Another publication called *Il Caffè*, devoted to arts, letters, and science, was published in Venice in 1850-52. Still another, having the same name, a national weekly journal, was published in Milan, 1884-89.

An almanac, having the title *Il Caffè*, was published in Milan in 1829.

A weekly paper, called *Il Caffè Pe-drocchi*, was published in Padua in 1846-48. It was devoted to art, literature, and politics.

A publication called *Coffee and Surrogates* (tea, chocolate, saffron, pepper, and other stimulants) was founded by Professor Pietro Polli, in Milan, in 1885; but was short-lived.

An early English magazine (1731) contains an account of divination by coffee-grounds. The writer pays an unexpected visit, and "surprised the lady and her company in close cabal over their coffee, the interest very intent upon one whom, by her address and intelligence, he guessed was a tire woman, to which she added the secret of divining by coffee grounds. She was then in full inspiration, and with much solemnity observing the atoms around the cup; on the one hand sat a widow, on the other a maiden lady. They assured me that every cast of the cup is a picture of all one's life to come, and every transaction and circumstance is delineated with the exactest certainty."

The advertisement used by this seer is quite interesting:

An advise is hereby given that there has lately arrived in this city (Dublin) the famous Mrs. Cherry, the only gentelwoman truly learned in the occult science of *tossing of coffee grounds*; who has with uninterrupted success for some time past practiced to the general satisfaction of her female visitants. Her hours are after prayers are done at St. Peter's Church, until dinner.

(N. B. She never requires more than 1 oz. of coffee from a single gentlewoman, and so proportioned for a second or third person, but not to exceed that number at any one time.)

If the one ounce of coffee represented her payment for reading the future, the charge could not be considered exorbitant!

English writers of the seventeenth and eighteenth centuries, were noticeably affected by coffee, and the coffee-houses of the times have been immortalized by them; and in many instances they themselves were immortalized by the coffee houses and their frequenters. In the chapters already referred to and at the close of this chapter, will be found stories, quips, and anecdotes, in which occur many names that are famous in art and literature.

Modern journalism dates from the publication, April 12, 1709, of the *Tatler*, whose editor was Sir Richard Steele (1672-1729) the Irish dramatist and essayist. He re-

ceived his inspiration from the coffee houses; and his readers were the men that knew them best. In the first issue he announced:

All accounts of gallantry, pleasure and entertainment shall be under the article of White's Coffee House; poetry under that of Will's Coffee House; learning under the title of Grecian; foreign and domestic news you will have from St. James's Coffee House, and what else I shall on any other subject offer shall be dated from my own apartment.

Steele's *Tatler* was issued three times weekly until 1711, when it suspended to be succeeded by the *Spectator*, whose principal contributor was Joseph Addison (1672-1719), the essayist and poet, and Steele's school-fellow.

Sir Richard Steele immortalized the Don and Don Saltero's coffee house in old Chelsea in No. 34 of the *Tatler*, wherein he tells us of the necessity of traveling to know the world, by his journey for fresh air, no farther than the village of Chelsea, of which he fancied that he could give an immediate description—from the five fields, where the robbers lie in wait, to the coffee house, where the literati sit in council. But he found, even in a place so near town as this, that there were enormities and persons of eminence, whom he before knew nothing of.

The coffee house was almost absorbed by the museum, Steele says:

When I came into the coffee-house, I had not time to salute the company, before my eyes were diverted by ten thousand gimcracks round the room, and on the ceiling. When my first astonishment was over, comes to me a sage of thin and meagre countenance, which aspect made me doubt whether reading or fretting had made it so philosophic; but I very soon perceived him to be that sort which the ancients call "gingivistee," in our language "tooth-drawers." I immediately had a respect for the man; for these practical philosophers go upon a very practical hypothesis, not to cure, but to take away the part affected. My love of mankind made me very benevolent to Mr. Salter, for such is the name of this eminent barber and antiquary.

The Don was famous for his punch, and for his skill on the fiddle. He drew teeth also, and wrote verses; he described his museum in several stanzas, one of which is:

Monsters of all sorts are seen:  
Strange things in nature as they grew so;  
Some relics of the Sheba Queen,  
And fragments of the fam'd Bob Crusoe.

Steele then plunges into a deep thought why barbers should go farther in hitting

the ridiculous than any other set of men; and maintains that Don Saltero is descended in a right line, not from John Tradescant, as he himself asserts, but from the memorable companion of the Knight of Mancha. Steele certifies to all the worthy citizens who travel to see the Don's rarities, that his double-barreled pistols, targets, coats of mail, his sclopeta (hand-culverin) and sword of Toledo, were left to his ancestor by the said Don Quixote; and by his ancestor to all his progeny down to Saltero. Though Steele thus goes far in favor of Don Saltero's great merit, he objects to his imposing several names, without his license, on the collection he has made, to the abuse of the good people of England; one of which is particularly calculated to deceive religious persons, to the great scandal of the well-disposed and may introduce heterodox opinions. Among the curiosities presented by Admiral Munden was a coffin, containing the body or relics of a Spanish saint, who had wrought miracles. Says Steele:

He shows you a straw hat, which I know to be made by Madge Peskad, within three miles of Bedford; and tells you "It is Pontius Pilate's wife's chambermaid's sister's hat." To my knowledge of this very hat, it may be added that the covering of straw was never used among the Jews, since it was demanded of them to make bricks without it. Therefore, this is nothing but, under the specious pretense of learning and antiquities, to impose upon the world. There are other things which I can not tolerate among his rarities, as, the china figure of the lady in the glass-case; the Italian engine, for the imprisonment of those who go abroad with it; both of which I hereby order to be taken down, or else he may expect to have his letters patent for making punch superseded, be debarred wearing his muff next winter, or ever coming to London without his wife.

Babillard says that Salter had an old grey muff, and that, by wearing it up to his nose, he was distinguishable at the distance of a quarter of a mile. His wife was none of the best, being much addicted to scolding; and Salter, who liked his glass, if he could make a trip to London by himself, was in no haste to return.

Don Saltero's proved very attractive as an exhibition, and drew crowds to the coffee house. A catalog was published of which were printed more than forty editions. Smollett, the novelist, was among the donors. The catalog, in 1760, comprehended the following rarities:

Tigers' tusks; the Pope's candle; the skeleton of a Guinea-pig; a fly-cap monkey, a piece of

the true Cross; the Four Evangelists' heads cut out on a cherry stone; the King of Morocco's tobacco-pipe; Mary Queen of Scots' pincushion; Queen Elizabeth's prayer-book; a pair of Nun's stockings; Job's ears, which grew on a tree; a frog in a tobacco stopper; and five hundred more odd relics!

The Don had a rival, as appears by *A Catalogue of the Rarities to be seen at Adam's, at the Royal Swan, in Kingsland-road, leading from Shoreditch Church, 1756*. Mr. Adams exhibited, for the entertainment of the curious:

Miss Jenny Cameron's shoes; Adam's eldest daughter's hat; the heart of the famous Bess Adams, that was hanged at Tyburn with Lawyer Carr, January 18, 1736-37; Sir Walter Raleigh's tobacco pipe; Vicar of Bray's clogs; engine to shell green peas with; teeth that grew in a fish's belly; Black Jack's ribs; the very comb that Abraham combed his son Isaac and Jacob's head with; Wat Tyler's spurs; rope that cured Captain Lowry of the head-ach, ear-ach, tooth-ach, and belly-ach; Adam's key of the fore and back door of the Garden of Eden, etc., etc.

These are only a few out of five hundred other equally marvellous exhibits.

The success of Don Saltero in attracting visitors to his coffee house, induced the proprietor of the Chelsea bunhouse to make a similar collection of rarities, to attract customers for his buns; and to some extent it was successful.

In the first number of the *Spectator*, Addison says:

There is no place of general resort wherein I do not often make my appearance. Sometimes I am seen thrusting my head into a round of politicians at Will's, and listening with great attention to the narratives that are made in those little circular audiences. Sometimes I smoke a pipe at Child's, and while I seem attentive to nothing but the *Postman*, overhear the conversation of every table in the room. I appear on Sunday nights at St. James' coffee house, and *sometimes* join the little committee of politics in the inner room as one who comes there to hear and improve. My face is likewise very well known at the Grecian, the Cocoa Tree, and in the theatres both of Drury Lane and the Hay Market. I have been taken for a merchant upon the Exchange for above these ten years, and sometimes pass for a Jew in the assembly of stock jobbers at Jonathan's; in short, wherever I see a cluster of people, I always mix with them, though I never open my lips, but in my own club.

In the second number he tells that:

I am now settled with a widow woman, who has a great many children and complies with my humor in everything. I do not remember that we have exchanged a word together for these five years; my coffee comes into my

chamber every morning without asking for it, if I want fire I point to the chimney, if water, to my basin; upon which my landlady nods as much as to say she takes my meaning, and immediately obeys my signals.

Three of Addison's papers in the *Spectator* (Nos. 402, 481, and 568) are humorously descriptive of the coffee houses of the period. No. 402 opens with the remark that:

The courts of two countries do not so much differ from one another, as the Court and the City, in their peculiar ways of life and conversation. In short, the inhabitants of St. James, notwithstanding they live under the same laws, and speak the same language, are a distinct people from those of Cheapside, who are likewise removed from those of the Temple on the one side, and those of Smithfield on the other, by several climates and degrees in their way of thinking and conversing together.

For this reason, the author takes a ramble through London and Westminster, to gather the opinions of his ingenious countrymen upon a current report of the death of the King of France.

I know the faces of all the principal politicians within the bills of mortality; and as every coffee-house has some particular statesman belonging to it, who is the mouth of the street where he lives, I always take care to place myself near him, in order to know his judgment on the present posture of affairs. And, as I foresaw the above report would produce a new face of things in Europe, and many curious speculations in our British coffee-houses, I was very desirous to learn the thoughts of our most eminent politicians on that occasion.

That I might begin as near the fountain-head as possible, I first of all called in at St. James's, where I found the whole outward room in a buzz of politics; the speculations were but very indifferent towards the door, but grew finer as you advanced to the upper end of the room, and were so much improved by a knot of theorists, who sat in the inner room, within the steams of the coffee-pot, that I there heard the whole Spanish monarchy disposed of, and all the line of Bourbons provided for in less than a quarter of an hour.

I afterwards called in at Giles's, where I saw a board of French gentlemen sitting upon the life and death of their grand monarch. Those among them who had espoused the Whig interest very positively affirmed that he had departed this life about a week since, and therefore, proceeded without any further delay to the release of their friends in the galleys, and to their own re-establishment; but, finding they could not agree among themselves, I proceeded on my intended progress.

Upon my arrival at Jenny Man's I saw an alert young fellow that cocked his hat upon a friend of his, who entered just at the same time with myself, and accosted him after the following manner; "Well, Jack, the old prig is dead

at last. Sharp's the word. Now or never, boy. Up to the walls of Paris, directly"; with several other deep reflections of the same nature.

I met with very little variation in the politics between Charing Cross and Covent Garden. And, upon my going into Will's, I found their discourse was gone off, from the death of the French King, to that of Monsieur Boileau, Racine, Corneille, and several other poets whom they regretted on this occasion as persons who would have obliged the world with very noble elegies on the death of so great a prince, and so eminent a patron of learning.

At a coffee-house near the Temple, I found a couple of young gentlemen engaged very smartly in a dispute on the succession to the Spanish monarchy. One of them seemed to have been retained as advocate for the Duke of Anjou, the other for his Imperial Majesty. They were both for regarding the title to that kingdom by the statute laws of England; but finding them going out of my depth, I pressed forward to Paul's Churchyard, where I listened with great attention to a learned man, who gave the company an account of the deplorable state of France during the minority of the deceased king.

I then turned on my right hand into Fish street, where the chief politician of that quarter, upon hearing the news, (after having taken a pipe of tobacco, and ruminated for some time) said, "If the King of France is certainly dead, we shall have plenty of mackerel this season: our fishery will not be disturbed by privateers, as it has been for these ten years past." He afterwards considered how the death of this great man would affect our pilchards, and by several other remarks infused a general joy into his whole audience.

I afterwards entered a by-coffee-house that stood at the upper end of a narrow lane, where I met with a Nonjuror engaged very warmly with a laceman who was the great support of a neighboring conventicle. The matter in debate was whether the late French King was most like Augustus Caesar or Nero. The controversy was carried on with great heat on both sides, and as each of them looked upon me very frequently during the course of their debate, I was under some apprehension that they would appeal to me, and therefore laid down my penny at the bar and made the best of my way to Cheapside.

I here gazed upon the signs for some time before I found one to my purpose. The first object I met in the coffee-room was a person who expressed a great grief for the death of the French King; but upon his explaining himself, I found his sorrow did not arise from the loss of the monarch, but for his having sold out of the Bank about three days before he heard the news of it. Upon which a haberdasher, who was the oracle of the coffee-house, and had his circle of admirers about him, called several to witness that he had declared his opinion, above a week before, that the French King was certainly dead; to which he added, that considering the late advices we had received from France, it was impossible that it could be otherwise. As he was laying these together, and debating to his hearers with great authority, there came a gentleman from



Garraway's, who told us that there were several letters from France just come in, with advice that the King was in good health, and was gone out a hunting the very morning the post came away; upon which the haberdasher stole off his hat that hung upon a wooden peg by him, and retired to his shop with great confusion. This intelligence put a stop to my travels, which I had prosecuted with so much satisfaction; not being a little pleased to hear so many different opinions upon so great an event, and to observe how naturally, upon such a piece of news, every one is apt to consider it to his particular interest and advantage.

Johnson wrote in his *Life of Addison* concerning the *Tatler* and the *Spectator* that they were:

Published at a time when two parties, loud, restless and violent, each with plausible declarations, and both perhaps without any distinct determination of its views, were agitating the nation; to minds heated with political contest they supplied cooler and more inoffensive reflections. . . . They had a perceptible influence on the conversation of the time, and taught the frolic and the gay to unite merriment with decency, effects which they can never wholly lose.

Harold Routh in the Cambridge *History of Literature*, speaking of the *Spectator*, says:

It surpassed the *Tatler* in style and in thought. It gave expression to the power of commerce. For more than a century traders had been characterized as dishonest and avaricious, because playwrights and pamphleteers generally wrote for the leisure classes, and were themselves too poor to have any but unpleasant relations with men of business. Now merchants were becoming ambassadors of civilization, and had developed intellect so as to control distant and, as it seemed, mysterious sources of wealth; by a stroke of the pen and largely through the coffee houses they had come to know their own importance and power.

Samuel Pepys (1633-1703) was very fond of good eating, and almost daily entries were made in his *Diary* of dinner delicacies that he had enjoyed. One dinner, that he considered a great success, was served to eight persons, and consisted of oysters, a hash of rabbits, a lamb, a rare chine of beef; next a great dish of roasting fowl ("cost me about 30 s.") a tart, then fruit and cheese. "My dinner was noble enough. I believe this day's feast will cost me near 5 pounds." But it will be noted that coffee was not mentioned as a part of the menu.

He makes countless references to visits paid to this and that coffee house, but records only one instance of actually drinking coffee:

Up betimes to my office, and thence at seven o'clock to Sir G. Carteret, and there with Sir J. Minnes made an end of his accounts, but staid not to dinner my Lady having made us drink our morning draft there of several wines, but I drank nothing but some of her coffee, which was poorly made, with a little sugar in it.

This note, which he considered worthy of record, was certainly not inspired by the excellence of the good lady's matutinal coffee.

William Cobbett (1762-1835), the English-American politician, reformer, and writer of economics, denounced coffee as "slops"; but he was one of a remarkably small minority. Before his day, one of England's greatest satirists, Dean Swift (1667-1745), led a long roll of literary men who were devotees of coffee.

Swift's writings are full of references to coffee; and his letters from Stella came to him under cover at the St. James coffee house. There is scarcely a letter to Esther (Vanessa) Vanhomrigh which does not contain a significant reference to coffee, by which the course of their friendship and clandestine meetings may be traced. In one dated August 13, 1720, written while traveling from place to place in Ireland, he says:

We live here in a very dull town, every valuable creature absent, and Cad says he is weary of it, and would rather prefer his coffee on the barrenest mountain in Wales than be king here.

A fig for partridges and quails,  
Ye dainties I know nothing of ye;  
But on the highest mount in Wales,  
Would choose in peace to drink my coffee.

In another letter, about two years later, replying to one in which Vanessa has reproached him and begged him to write her soon, he advises:

The best maxim I know in life, is to drink your coffee when you can, and when you cannot, to be easy without it; while you continue to be splenetic, count upon it I will always preach. Thus much I sympathize with you, that I am not cheerful enough to write, for, I believe, coffee once a week is necessary, and you know very well that coffee makes us severe, and grave, and philosophical.

These various references to coffee are thought to have been based upon an incident in the early days of their friendship, when on the occasion of the Vanhomrigh family journeying from Dublin to London, Vanessa accidentally spilt her coffee in the chimney-place at a certain inn, which Swift

considered an omen of their growing friendship. Writing from Clogher, Swift reminds Vanessa:

Remember that riches are nine parts in ten of all that is good in life, and health is the tenth—drinking coffee comes long after, and yet it is the eleventh, but without the two former you cannot drink it right.

In another letter he writes facetiously, in memory of her playful badinage:

I long to drink a dish of coffee in the sluttery and hear you dun me for a secret, and "Drink your coffee; why don't you drink your coffee?"

Leigh Hunt had very pleasant things to say about coffee, giving to it the charm of appeal to the imagination, which he said one never finds in tea. For example:

Coffee, like tea, used to form a refreshment by itself, some hours after dinner; it is now taken as a digester, right upon that meal or the wine, and sometimes does not even close it; or the digester itself is digested by a liquor of some sort called a *Chasse-Café* [coffee-chaser]. We like coffee better than tea for taste, but tea "for a constancy." To be perfect in point of relish (we do not say of wholesomeness) coffee should be strong and hot, with little milk and sugar. It has been drunk after this mode in some parts of Europe, but the public have nowhere, we believe, adopted it. The favorite way of taking it at a meal, abroad, is with a great superfluity of milk—very properly called, in France *café au lait* (coffee to the milk). One of the pleasures we receive in drinking coffee is that, being the universal drink in the East, it reminds of that region of the Arabian Nights as smoking does for the same reason; though neither of these refreshments, which are identified with Oriental manners, is to be found in that enchanting work. They had not been discovered when it was written; the drink then was sherbet. One can hardly fancy what a Turk or a Persian could have done without coffee and a pipe, any more than the English ladies and gentlemen, before the civil wars, without tea for breakfast.

In his old age, Immanuel Kant, the great metaphysician, became extremely fond of coffee; and Thomas de Quincey relates a little incident showing Kant's great eagerness for the after-dinner cup.

At the beginning of the last year of his life, he fell into a custom of taking, immediately after dinner, a cup of coffee, especially on those days when it happened that I was of his party. And such was the importance that he attached to his little pleasure that he would even make a memorandum beforehand, in the blank paper book that I had given him, that on the next day I was to dine with him, and consequently "that there was to be coffee." Some-

times in the interest of conversation, the coffee was forgotten, but not for long. He would remember and with the querulousness of old age and infirm health would demand that coffee be brought "upon the spot." Arrangements had always been made in advance, however; the coffee was ground, and the water was boiling; and in the very moment the word was given, the servant shot in like an arrow and plunged the coffee into the water. All that remained, therefore, was to give it time to boil up. But this trifling delay seemed unendurable to Kant. If it were said, "Dear Professor, the coffee will be brought up in a moment," he would say, "Will be! There's the rub, that it only *will* be." Then he would quiet himself with a stoical air, and say, "Well, one can die after all; it is but dying; and in the next world, thank God, there is no drinking of coffee and consequently no waiting for it."

When at length the servant's steps were heard upon the stairs, he would turn round to us, and joyfully call out: "Land, land! my dear friends, I see land."

Thackeray (1811-1863) must have suffered many tea and coffee disappointments. In the *Kickleburys on the Rhine* he asks: "Why do they always put mud into coffee aboard steamers? Why does the tea generally taste of boiled boots?"

In *Arthur's*, A. Neil Lyons has preserved for all time the atmosphere of the London coffee stall. "I would not," he says, "exchange a night at Arthur's for a week with the brainiest circle in London." The book is a collection of short stories. As already recorded, Harold Chapin dramatized this picturesque London institution in *The Autocrat of the Coffee Stall*.

In General Horace Porter's *Campaigning with Grant*, we have three distinct coffee incidents within fifty-odd pages; or explicitly, see pages 47, 56, 101; where, deep in the fiercest snarls of The Wilderness campaign we are treated to:

General Grant, slowly sipping his coffee . . . a full ration of that soothing army beverage . . . The general made rather a singular meal preparatory to so exhausting a day as that which was to follow. He took a cucumber, sliced it, poured some vinegar over it, and partook of nothing else except a cup of strong coffee . . . The general seemed in excellent spirits, and was even inclined to be jocose. He said to me, "We have just had our coffee, and you will find some left for you." . . . I drank it with the relish of a shipwrecked mariner.

One of the first immediate supplies General Sherman desired from Wilmington, on reaching Fayetteville and lines of communication in March, 1865, was, expressly, coffee; does he not say so himself, on page 297 of the second volume of his *Memoirs*?

Still more expressly, towards the close of his *Memoirs*, and among final recommendations, the fruit of his experiences in that whole vast war, General Sherman says this for coffee:

Coffee has become almost indispensable, though many substitutes were found for it, such as Indian corn, roasted, ground and boiled as coffee, the sweet potato, and the seed of the okra plant prepared in the same way. All these were used by the people of the South, who for years could procure no coffee, but I noticed that the women always begged of us real coffee, which seemed to satisfy a natural yearning or craving more powerful than can be accounted for on the theory of habit. Therefore I would always advise that the coffee and sugar ration be carried along, even at the expense of bread, for which there are many substitutes.

George Agnew Chamberlain's novel *Home* contains a vivid description of coffee-making on an old plantation, and could only have been written by a devoted lover of this drink. Gerry Lansing, the American, has escaped drowning in the river, and is now lost in the Brazilian forest. He finds his way at last to an old plantation house:

A stove was built into the masonry, and a cavernous oven gaped from the massive wall. At the stove was an old negress, making coffee with shaky deliberation. . . The girl and the wrinkled old woman made him sit down at the table, and then placed before him crisp rusks of mandioc flour and steaming coffee whose splendid aroma triumphed over the sordidness of the scene and through the nostrils reached the palate with anticipatory touch. It was sweetened with dark, pungent syrup and was served black in a capacious bowl, as though one could not drink too deeply of the elixir of life. Gerry ate ravenously and sipped the coffee, at first sparingly, then greedily. . . Gerry set down the empty bowl with a sigh. The rusks had been delicious. Before the coffee the name of nectar dwindled to impotency. Its elixir rioted in his veins.

In the *Rosary*, Florence L. Barclay has a Scotch woman tell how she makes coffee. She says:

Use a jug—it is not what you make it in; it is how ye make it. It all hangs upon the word fresh—freshly roasted—freshly ground—water freshly boiled. And never touch it with metal. Pop it into an earthen jug, pour in your boiling water straight upon it, stir it with a wooden spoon, set it on the hob ten minutes to settle; the grounds will all go to the bottom, though you might not think it, and you pour it out, fragrant, strong and clear. But the secret is, *fresh, fresh, fresh*, and don't stint your coffee.

Cyrus Townsend Brady's *The Corner in*

*Coffee* is "a thrilling romance of the New York coffee market."

Coffee, Du Barry, and Louis XV figure in one scene of the story of *The Moat with the Crimson Stains*, as told by Elizabeth W. Champney in her *Romance of the Bourbon Chateaux*. It tells of the German apprentice Riesener, who assisted his master Oeben in designing for Louis XV a beautiful desk with a secret drawer, which it took ten years of unremitting industry to execute. At the end, Riesener was to be accepted by his master as a partner and a son-in-law. Little Victoire, who loved to sit in a punt and trail her doll in the waters of the Bievre to see to what color its frock would be changed by the dyes of the Gobelins factory, was then only five, and Madam Oeben twenty-three. As the years rolled by Riesener grew to love the mother and not the daughter, who, meanwhile, shot up into a slim girl, not of her mother's beauty, but of a loveliness all her own. Then there was a quarrel because the young apprentice thought the master should have resented the suggestion of M. Duplessis that his wife pose in the nude for the statuettes which were to hold the sconces on the king's desk; and Riesener left in a fine youthful frenzy, vowing he would never return while the *Maitre* lived. The latter, unable to complete the masterpiece which he loved more than anything else on earth, sought death, and perished in the crimson waters of the Bievre.

The *maitre* had no enemies, but his quarrel with Riesener caused a fear to spring up in the widow's heart that the apprentice might have been guilty of his murder, so she refused to see him when, hearing of his master's death, he returned, stricken with remorse, to finish the desk. On it were the statuettes modeled in perfect likeness of Mlle. de Vaubernier, a wily little milliner of Riesener's bohemian set who had taken this way to bring herself to the attention of Louis XV. The ruse was successful; and after the acceptance of the desk, there was installed a new *maîtresse en titre*, the notorious Madame Du Barry, erstwhile the pretty milliner, Mlle. de Vaubernier.

Later, Madame Du Barry sent for the now famous *ebeniste* (cabinet maker); and, when her negro page Zamore admitted him, he found His Majesty Louis XV kneeling in front of the fireplace, making coffee for her while she laughed at him for scalding his fingers. He had been summoned to

show the king the mechanism of the secret drawer, so cunningly concealed in the king's desk that no one could find it. But Riesener knew not the secret of his master, who had died without revealing it. Then the red revolution came; and when the pretty pavilion at Louveciennes was sacked, and its costly furniture hurled down the cliff to the Seine, the king's desk, shattered almost beyond repair, was carried to the Goeblins' factory and presented to Mme. Oeben in recognition of her husband's workmanship. Then the secret compartment was found to have been disclosed, and Riesener was absolved by a letter therein, from the *maître*, who intimated he was about to end it all because of paralysis. Riesener married the widow and all ended happily.<sup>6</sup>

James Lane Allen, in *The Kentucky Warbler*, tells a tale of the Blue Grass country and of a young hero who wanders after a bird's note to find romance and the key to his own locked nature. Here is an incident from his first forest adventure:

There was one tree he curiously looked around for, positive that he should not be blind to it if fortunate enough to set his eyes on one—the coffee tree. That is, he felt sure he'd recognize it if it yielded coffee ready to drink, of which never in his life had they given him enough. Not once throughout his long troubled experience as to being fed had he been allowed as much coffee as he craved. Once, when younger, he had heard some one say that the only tree in all the American forests that bore the name of Kentucky was the Kentucky coffee tree, and he had instantly conceived a desire to pay a visit in secret to that corner of the woods. To take his cup and a few lumps of sugar and sit under the boughs and catch the coffee as it dripped down . . . No one to hold him back . . . as much as he wanted at last . . . The Kentucky coffee tree—his favorite in Nature!

John Kendrick Bangs relates, in *Coffee and Repartee*, some amusing skirmishes indulged in at the boarding-house table, between the Idiot and the guests, where coffee served the purpose of enlivening the tilt:

"Can't I give you another cup of coffee?" asked the landlady of the School Master.

"You may," returned the School Master, pained at the lady's grammar, but too courteous to call attention to it save by the emphasis with which he spoke the word "may."

Said the Idiot: "You may fill my cup too, Mrs. Smithers."

"The coffee is all gone," returned the landlady, with a snap.

<sup>6</sup> Copyright, 1903, by G. P. Putnam's Sons, New York. Used by courtesy of the author and the publisher.

"Then, Mary," said the Idiot, gracefully turning to the maid, "you may give me a glass of ice water. It is quite as warm, after all, as the coffee and not quite so weak."

One other little skit remains at the expense of Mrs. Smithers' coffee. At the breakfast table, where the air, as usual, is charged with repartee, Mr. Whitechoker, the minister says to his landlady:

"Mrs. Smithers, I'll have a dash of hot water in my coffee, this morning. Then with a glance toward the Idiot, he added, "I think it looks like rain."

"Referring to the coffee, Mr. Whitechoker?" queried the Idiot.

"Ah,—I don't quite follow you," replied the Minister with some annoyance.

"You said something looked like rain, and I asked you if the thing referred to was the coffee, for I was disposed to agree with you," said the Idiot.

"I am sure," put in Mrs. Smithers, "that a gentleman of Mr. Whitechoker's refinement would not make any such insinuation, sir. He is not the man to quarrel with what is set before him."

"I must ask your pardon, Madam," returned the Idiot politely. "I hope I am not the man to quarrel with my food, either. Indeed, I make it a rule to avoid unpleasantness of all sorts, particularly with the weak, under which category I find your coffee."<sup>7</sup>

#### *Coffee Quips and Anecdotes*

Coffee literature is full of quips and anecdotes. Probably the most famous coffee quip is that of Mme. de Sévigné, who, as already told in chapter X, was wrongfully credited with saying, "Racine and coffee will pass." It was Voltaire in his preface to *Irene* who thus accused the amiable letter-writer; and she, being dead, could not deny it.

That Mme. de Sévigné was at one time a coffee drinker is apparent from this quotation from one of her letters: "The cavalier believes that coffee gives him warmth, and I at the same time, foolish as you know me, do not take it any longer."

La Roque called the beverage "the King of Perfumes," whose charm was enriched when vanilla was added.

Emile Souvestre (1806-1854) said: "Coffee keeps, so to say, the balance between bodily and spiritual nourishment."

Isid Bourdon said: "The discovery of coffee has enlarged the realm of illusion and given more promise to hope."

An old Bourbon proverb says: "To an old man a cup of coffee is like the door

<sup>7</sup> Copyright, 1893, by Harper Bros., and 1921, by John Kendrick Bangs. Reprinted by permission.

post of an old house—it sustains and strengthens him.”

Jardin says that in the Antilles, instead of orange blossoms, the brides carry a spray of coffee blossoms; and when a woman remains unmarried, they say she has lost her coffee branch. “We say in France, that she has *coiffé* Sainte-Catherine.”

Fontenelle and Voltaire have both been quoted as authors of the famous reply to the remark that coffee was a slow poison: “I think it must be, for I’ve been drinking it for eighty-five years and am not dead yet.”

In Meidinger’s *German Grammar* the “slow-poison” *bon mot* is attributed to Fontenelle.

It seems reasonable to give Fontenelle credit for this *bon mot*. Voltaire died at eighty-four. Fontenelle lived to be nearly a hundred years. Of his cheerfulness at an advanced age an anecdote is related. In conversation, one day, a lady a few years younger than Fontenelle playfully remarked, “Monsieur, you and I stay here so long, methinks Death has forgotten us.” “Hush! Speak in a whisper, madame.” replied Fontenelle, “*tant mieux!* (so much the better!) don’t remind him of us.”

Flaubert, Hugo, Baudelaire, Paul de Kock, Théophile Gautier, Alfred de Musset, Zola, Coppée, George Sand, Guy de Maupassant, and Sarah Bernhardt, all have been credited with many clever or witty sallies about coffee.

Prince Talleyrand (1754-1839), the French diplomat and wit, has given us the cleverest summing up of the ideal cup of coffee. He said it should be “*Noir comme le diable, chaud comme l’enfer, pur comme un ange, doux comme l’amour.*” Or in English, “black as the devil, hot as hell, pure as an angel, sweet as love.”

This quip has been wrongfully attributed to Brillat-Savarin. Talleyrand said also:

A cup of coffee lightly tempered with good milk detracts nothing from your intellect; on the contrary, your stomach is freed by it, and no longer distresses your brain; it will not hamper your mind with troubles, but give freedom to its working. Suave molecules of Mocha stir up your blood, without causing excessive heat; the organ of thought receives from it a feeling of sympathy; work becomes easier, and you will sit down without distress to your principal repast, which will restore your body, and afford you a calm delicious night.

Among coffee drinkers a high place must be given to Prince Bismarck (1815-1898).

He liked coffee unadulterated. While with the Prussian army in France, he one day entered a country inn and asked the host if he had any chicory in the house. He had. Bismarck said: “Well, bring it to me; all you have.” The man obeyed, and handed Bismarck a canister full of chicory.

“Are you sure this is all you have?” demanded the chancellor.

“Yes, my lord, every grain.”

“Then,” said Bismarck, keeping the canister by him, “go now and make me a pot of coffee.”

This same story has been related of François Paul Jules Grévy (1807-1891), president of France, 1879-1887. According to the French story, Grévy never took wine, even at dinner. He was, however, passionately fond of coffee. To be certain of having his favorite beverage of the best quality, he always, when he could, prepared it himself. Once he was invited, with a friend, M. Bethmont, to a hunting party by M. Menier, the celebrated manufacturer of chocolate, at Noisiel. It happened that M. Grévy and M. Bethmont lost themselves in the forest. Trying to find their way out, they stumbled upon a little wine house, and stopped for a rest. They asked for something to drink. M. Bethmont found his wine excellent; but, as usual, Grévy would not drink. He wanted coffee, but he was afraid of the decoction which would be brought him. He got a good cup, however, and this is how he managed it:

“Have you any chicory?” he said to the man.

“Yes, sir.”

“Bring me some.”

Soon the proprietor returned with a small can of chicory.

“Is that all you have?” asked Grévy.

“We have a little more.”

“Bring me the rest.”

When he came again, with another can of chicory, Grévy said:

“You have no more?”

“No, sir.”

“Very well. Now go and make me a cup of coffee.”

As already told, Louis XV had a great passion for coffee, which he made himself. Lenormand, the head gardener at Versailles, raised six pounds of coffee a year which was for the exclusive use of the king. The king’s fondness for coffee and for Mme. Du Barry gave rise to a celebrated anecdote of Louveciennes which was accepted as true



by many serious writers. It is told in this fashion by Mairobert in a pamphlet scandalizing Du Barry in 1776:

His Majesty loves to make his own coffee and to forsake the cares of the government. One day the coffee pot was on the fire and, his Majesty being occupied with something else, the coffee boiled over. "Oh France, take care! Your coffee *f— le camp!*" cried the beautiful favorite.

Charles Vatel has denied this story.

It is related of Jean Jacques Rousseau that once when he was walking in the Tuileries he caught the aroma of roasting coffee. Turning to his companion, Bernardino de Saint-Pierre, he said, "Ah, that is a perfume in which I delight; when they roast coffee near my house, I hasten to open the door to take in all the aroma." And such was the passion for coffee of this philosopher of Geneva that when he died, "he just missed doing it with a cup of coffee in his hand."

Barthez, confidential physician of Napoleon the first, drank a great deal of it, freely, calling it "the intellectual drink."

Bonaparte, himself, said: "Strong coffee, and plenty, awakens me. It gives me a warmth, an unusual force, a pain that is not without pleasure. I would rather suffer than be senseless."

Edward R. Emerson tells the following story of the Café Procope. One day while M. Saint-Foix was seated at his usual table in this café an officer of the king's body-guard entered, sat down, and ordered a cup of coffee, with milk and a roll, adding, "It will serve me for a dinner." At this, Saint-Foix remarked aloud that a cup of coffee, with milk and a roll, was a confoundedly poor dinner. The officer remonstrated. Saint-Foix reiterated his remark, adding that nothing he could say to the contrary would convince him that it was *not* a confoundedly poor dinner. Thereupon a challenge was given and accepted, and the whole company present adjourned as spectators to a duel which ended by Saint-Foix receiving a wound in the arm.

"That is all very well," said the wounded combatant; "but I call you to witness, gentlemen, that I am still profoundly convinced that a cup of coffee, with milk and a roll, is a confoundedly poor dinner."

At this moment the principals were arrested and carried before the Duke de Noailles, in whose presence Saint-Foix, without waiting to be questioned, said:

"Monseigneur, I had not the slightest in-

tention of offending this gallant officer who, I doubt not, is an honorable man; but your excellency can never prevent my asserting that a cup of coffee, with milk and a roll, is a profoundedly poor dinner."

"Why, so it is," said the Duke.

"Then I am not in the wrong," persisted Saint-Foix; "and a cup of coffee"—at these words magistrates, delinquents, and auditory burst into a roar of laughter, and the antagonists forthwith became warm friends.<sup>8</sup>

Boswell in his *Life of Johnson* tells a story of an old chevalier de Malte, of *ancienne noblesse*, but in low circumstances, who was in a coffee house in Paris, where was also "Julien, the great manufacturer at Gobelins, of fine tapestry, so much distinguished for the figures and the colours. The chevalier's carriage was very old. Says Julien with a plebeian insolence, 'I think, sir, you had better have your carriage new painted.'

"The chevalier looked at him with indignant contempt, and answered:

"Well, sir, you may take it home and dye it."

"All the coffee house rejoiced at Julien's confusion."

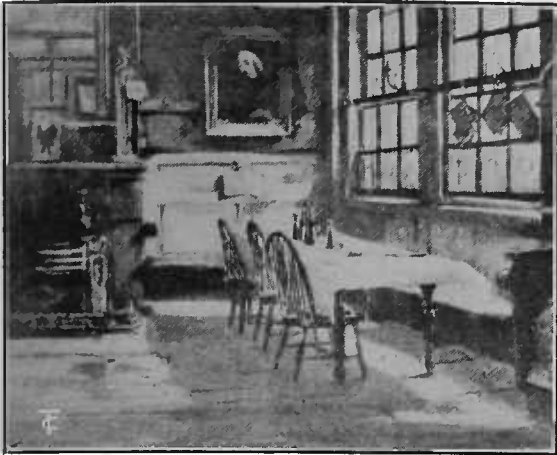
Sydney Smith (1771-1845), the English clergyman and humorist, once said: "If you want to improve your understanding, drink coffee; it is the intellectual beverage."

Our own William Dean Howells paid the beverage this tribute: "This coffee intoxicates without exciting, soothes you softly out of dull sobriety, making you think and talk of all the pleasant things that ever happened to you."

The wife of the late President Harding preferred coffee to tea. Afternoon guests at the White House might be refreshed, if they chose, by a sip of tea. But while tea was on tap for callers, Mrs. Harding always had coffee for those who, like herself, preferred it.

Will Irwin tells a story about the late General Hugh L. Scott in which coffee plays the star part in an Indian rebellion. There arose among the Navajos, at Beautiful Mountain, a medicine man prophet, a kind of Southwestern Sitting Bull, whose guiding spirit told him that the gods were going to send a deluge to drown out the white man. It would fill the valleys, rise almost to the tops of the mountain peaks.

<sup>8</sup>*Beverages Past and Present*, New York, copyright 1908. By courtesy of G. P. Putnam's Sons, Publishers.



DR. JOHNSON'S SEAT AT THE CHESHIRE CHEESE

The Navajos must withdraw to the high mountains. When the deluge receded, the white men would all be dead and the country would no longer be arid. There would follow another golden age in which the Navajos, blessed by peace and plenty, would be lords of the world. His following grew. They danced themselves into a frenzy, and one day they trekked in great numbers to the summit of Beautiful Mountain, where they sat down to wait.

These fanatics were mostly men. The women stayed at home and attended to their weaving. The flocks became neglected and famine loomed. Bootleg rifles and ammunition began to arrive at Beautiful Mountain. The government sent for General Scott. He knew his Navajos. He knew their special weakness for coffee. They have no affinity for alcohol. When the father of a family sells one of his wife's rugs at the trading post he usually buys a pound of coffee and a little sugar. The squaws serve it on special occasions.

General Scott rode up Beautiful Mountain to see what could be done. With him went two or three mounted orderlies and a small train of pack mules. These last carried twenty pounds of coffee, corresponding quantities of sugar, several cases of condensed milk, some big coffee pots and a lot of nested tin cups. Arrived under flag of truce, General Scott addressed the Indians in a melange of English, Navajo, and a sign language. He and his men must ask their hospitality, he said. It seemed an imposition, since their provisions, he knew, were running low. But he had brought them a gift. How would they like a cup of coffee all around?

Savage enthusiasm lit the eyes of the Navajos. Instantly fifty Indians rushed to build fires. They had one cup, another, and still another. And sweet peace descended upon their spirits. Their hearts opened to the son of the Great White Father. They listened to his arguments. Before night General Scott was riding down the trail to Shiprock. And behind him, still in a pleasant state of nervous well-being, marched all the forces of the recent Navajo rebellion.

#### *Old London Coffee-House Anecdotes*

A good-sized volume might be compiled of the many anecdotes that have been written about habitués of the London coffee houses of the seventeenth and eighteenth centuries.

Dr. Samuel Johnson (1709-1784), the lexicographer, was one of the most constant frequenters of the coffee houses of his day. His big, awkward figure was a familiar sight as he went about attended by his satellite, young James Boswell, who was to write about him for the delight of future generations in his marvelous *Life of Johnson*. The intellectual and moral peculiarities of the man found a natural expression in the coffee house. Johnson was fifty-four and Boswell only twenty-three when the two first met in Tom Davies' book-shop in Covent Garden. The story is told by Boswell with great particularity and characteristic naiveté:

Mr. Davies mentioned my name, and respectfully introduced me to him. I was much agitated, and recollecting his prejudice against the Scotch, of which I had heard so much, I said to Davies, "Don't tell him where I come from." "From Scotland," cried Davies roguishly. "Mr. Johnson," said I, "I do indeed come from Scotland, but I cannot help it." I am willing to flatter myself that I meant this as a light pleasantry to sooth and conciliate him, and not as a humiliating abasement at the expense of my country. But however that might be, this speech was somewhat unlucky, for with that quickness of wit for which he was so remarkable, he seized the expression, "come from Scotland!" which I used in the sense of being of that country; and, as if I had come away from it, or left it, he retorted, "That, sir, I find is what a great many of your countrymen cannot help."

Nothing daunted, however, Boswell within a week called upon Johnson in his chambers. This time the doctor urged him to tarry. Three weeks later he said to him, "Come to me as often as you can." With-



THE OLD TABARD INN, SOUTHWARK

in a fortnight thereafter Boswell was giving the great man a sketch of his own life and Johnson was exclaiming, "Give me your hand; I have taken a liking to you."

When people began to ask, "who is this Scotch cur at Johnson's heels?" Goldsmith replied: "He is not a cur; he is only a bur. Tom Davies flung him at Johnson in sport, and he has the faculty of sticking."

Thus began one of the strangest friendships, out of which developed the most delightful biography in all literature. Boswell's taste for literary adventures, and Johnson's literary vagrancy met in a companionship that found much satisfaction in the bohemianism of the inns and coffee houses of old London. Boswell thus describes the eccentric doctor's outlook on this mode of living:

We dined today at an excellent inn at Chapel-House, where Mr. Johnson commented on English coffee houses and inns remarking that the English triumphed over the French in one respect, in that the French had no perfection of tavern life. There is no private house, (said he), in which people can enjoy themselves so well, as at a capital tavern. Let there be ever so great plenty of good things, ever so much grandeur, ever so much elegance, ever so much desire that everybody should be easy; in the nature of things it cannot be: there must always be some degree of care and anxiety. The master of the house is anxious to entertain his guests; the guests are anxious to be agreeable to him; and no man, but a very impudent dog indeed, can as freely command what is in another man's house, as if it were his own. Whereas, at a tavern, there is a general freedom from anxiety. You are sure you are welcome: and the more noise you make, the more trouble you give, the more good things you call for, the welcomer you are. No servants will attend you with alacrity which waiters do, who are incited by the prospect of an immediate reward in proportion as they please. No, Sir, there is nothing which has yet been contrived by man, by which so much happiness is produced as by a good tavern or inn. He then repeated, with great emotion, Shenstone's lines:

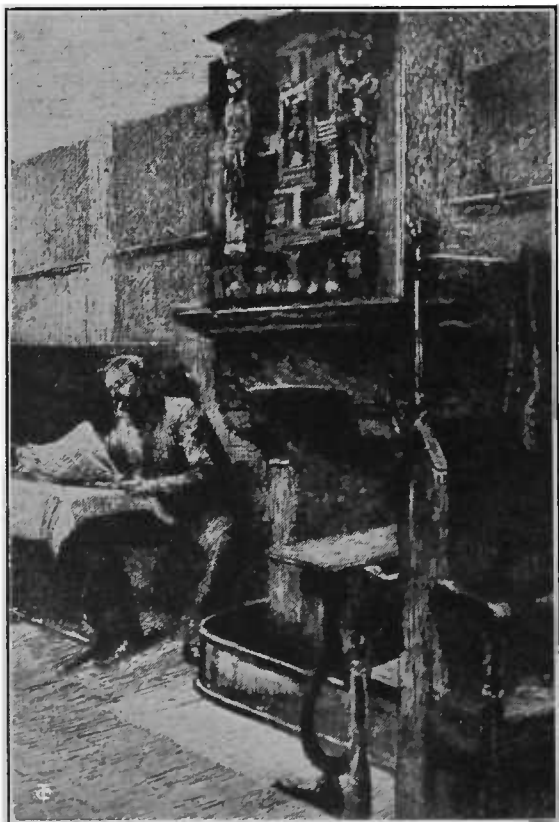
"Who'er has travell'd life's dull round,  
Where'er his stages may have been,  
May sigh to think he still has found  
His warmest welcome at an inn."

Patient delving into Johnsoniana is rewarded with many anecdotes about the mad doctor philosopher and his faithful reporter who delighted in translating his genius to the world.

Boswell was a wine-bibber, but Johnson confessed to being "a hardened and shameless tea drinker." When Boswell twiggd him for abstaining from the stronger drink, the doctor replied: "Sir, I have no objection to a man's drinking wine if he can do it in moderation. I find myself apt to go to excess in it and therefore, after having been for some time without it, on account of illness, I thought it better not to return to it."

Another time he said of tea: "What a delightful beverage must that be that pleases all palates at a time when they can take nothing else at breakfast."

In his early days Johnson had David Garrick as an unwilling pupil. After the actor had become famous and his prosperity



FIREPLACE IN THE COFFEE ROOM OF THE OLD COCK TAVERN



MORNING GOSSIP IN THE COFFEE ROOM OF THE OLD COCK TAVERN

had turned his head, he was wont to "put the table in a roar" by mimicking the doctor's grimaces. There is a story that on the occasion of a certain dinner party where both were guests, Garrick indulged in a coarse jest on the great man's table manners. After the merriment had subsided, Doctor Johnson arose solemnly and said:

"Gentlemen, you must doubtless suppose from the extreme familiarity with which Mr. Garrick has thought fit to treat me that I am an acquaintance of his; but I can assure you that until I met him here, I never saw him but once before—and then I paid five shillings for the sight."

A certain sycophant, thinking to curry favor with Johnson, took to laughing loud and long at everything he said. Johnson's patience at last became exhausted, and after a particularly objectionable outburst, he turned upon the boor with:

"Pray sir, what is the matter? I hope I have not said anything which you can comprehend!"

Because of his physical and mental disabilities Dr. Johnson was not a good social animal. Nevertheless, when it pleased his

humor, he could be the cavalier, for his mind overcame every impediment.

It is related of him that once when a lady who was showing him around her garden expressed her regret at being unable to bring a particular flower to perfection, he arose gallantly to the occasion by taking her hand and remarking:

"Then madam, permit me to bring perfection to the flower!"

Again, when Mrs. Siddons, the great English tragedienne, called upon him in his chambers and the servant did not promptly bring her a chair, his quick wit made capital of the incident by the remark:

"You see, madam, wherever you go there are no seats to be had!"

John Thomas Smith in his *Antiquarian Rambles in the Streets of London* (1846), tells an amusing incident in the life of Sir George Etherege, the playwright, who, having run up a bill at Locket's ordinary, a coffee house much frequented by dramatists of the period, and finding himself unable to pay, began to absent himself from the place. Mrs. Locket thereupon sent a man to dun and to threaten him with prosecution if he did not pay. Sir George sent

back word that if she stirred a step in the matter he would kiss her. On receiving this answer, the good lady, much exasperated, called for her hood and scarf, and told her husband, who interposed, that "she would see if there was any fellow alive who would have the impudence—" "Prithee! my dear, don't be so rash," said her husband; "there is no telling what a man may do in his passion."

Richard Savage, the English poet and friend of Johnson, who included him in his famous *Lives of the Poets*, was arrested for the murder of James Sinclair after a drunken brawl in Robinson's coffee house in 1727. He was found guilty, but narrowly escaped the death penalty by the intercession of the countess of Hertford. A feature of his trial was the extraordinary charge to the jury of Judge Page, who for his hard words and his love of hanging, is damned to everlasting fame in the verse of Pope. The charge was:

Gentlemen of the jury! You are to consider that Mr. Savage is a very great man, a much greater man than you or I, gentlemen of the jury; that he wears very fine clothes, much finer than you or I, gentlemen of the jury; that he has an abundance of money in his pocket, much more money than you or I, gentlemen of the jury; but, gentlemen of the jury, is it not a very hard case, gentlemen of the jury, that Mr. Savage should therefore kill you or me, gentlemen of the jury?

Albert V. Lally has made a collection of old coffee-house anecdotes. Among them are the following:

The story is told of how Sir Richard Steele in Button's Coffee House was once made the umpire in an amusing difference between two unnamed disputants. These two were arguing about religion, when one of them said: "I wonder, sir, you should talk of religion, when I'll hold you five guineas, you can't say the Lord's prayer." "Done," said the other, "and Sir Richard Steele shall hold the stakes." The money being deposited the gentleman began with, "I believe in God," and so went right through the creed. "Well," said the other when he had finished, "I didn't think he could have done it."

There is another story of a famous judge, Sir Nicholas Bacon, who was importuned by a criminal to spare his life on account of kinship. "How so," demanded the judge. "Because my name is Hog and yours is Bacon; and hog and bacon are so near akin that they cannot be separated."

"Ay," responded the judge dryly, "but you and I cannot yet be kindred, for hog is not bacon until it is well hanged."

On another occasion a nervous barrister, pleading before this same judge, began with re-

peated references to his "unfortunate client." "Go on, sir," said the judge, "so far the Court is with you."

Of Jonathan Swift it is related that a gentleman who had sought to persuade him to accept an invitation to dinner said, in way of special inducement, "I'll send you my bill of fare." "Send me rather your bill of company," retorted Swift, showing his appreciation of the truth that not that which is eaten, but those who eat, form the more important part of a good dinner.

On the occasion when the "dreadful Judge Jeffreys" was trying Compton, bishop of London, before the Court of High Commission, that prelate, as Campbell relates in his *Lives of the Lord Chancellors*, complained of having no copy of the indictment. Jeffreys replied to this excuse that "all the coffee houses had it for a penny." The case being resumed after the lapse of a week, the bishop again protested that he was unprepared, owing to his continued difficulty in obtaining a copy of the necessary document. Jeffreys was obliged once more to adjourn the case, and in so doing offered this bantering apology:

"My lord," said he, "in telling you our commission was to be seen in every coffee house, I did not speak with any design to reflect on your lordship, as if you were a haunter of coffee houses. I abhor the thoughts of it!"

As the Judge had once been distinctly opposed to the party and principles which he went to such a length in supporting, so had he formerly owed something to the very institution against which his last blow was directed. Roger North relates, and Campbell repeats the story, that, "after he was called to the bar, he used to sit in coffee houses and order his man to come and tell him that company attended him at his chamber; at which he would huff and say, 'let them stay a little, I will come presently,' and thus made a show of business."<sup>9</sup>

John Timbs, in his *Clubs and Club Life in London*, has a host of anecdotes and stories of the old London coffee houses among them the following:

Garraway's noted coffee-house, situated in Change-alley, Cornhill, had a threefold celebrity; tea was first sold in England here; it was a place of great resort in the time of the South Sea Bubble; and was later a place of great mercantile transactions. The original proprietor was Thomas Garway, tobacconist and coffee-man, the first who retailed tea, recommending it as a cure of all disorders.

<sup>9</sup> *The Pot and Kettle*, Boston, 1920 (vol. iii: no 2).





"HIS WARMEST WELCOME AT AN INN"

The George Inn of today has retained a portion of its old galleries, the original of which completely surrounded the courtyard in typical "Dickens Inn" style. The visitor can imagine Mr. Pickwick emerging from the door of one of the bedrooms and calling into the yard to Sam Weller. In the old-fashioned coffee room on the ground floor one may still lunch and dine enclosed in high bench seats

Ogilby, the compiler of the *Britannia*, had his standing lottery of books at Mr. Garway's Coffee-house from April 7, 1673, till wholly drawn off. And, in the "Journey through England," 1722, Garraway's Robins's, and Joe's are described as the three celebrated coffee-houses: "In the first, the People of Quality, who have business in the City, and the most considerable and wealthy citizens frequent. In the second the Foreign Banquiers, and often even Foreign Ministers. And in the third, the buyers and sellers of stock."

Wines were sold at Garraway's in 1673, "by the candle," that is, by auction, while an inch of candle burns. In the *Tatler*, No. 147, we read: "Upon my coming home last night, I found a very handsome present of French wine, left for me, as a taste of 216 hogshead, which are to be put on sale at 20£ a hogshead, at Garraway's Coffee-house, in Exchange alley," etc. The sale by candle is not, however, by candle-light, but during the day. At the commencement of the sale, when the auctioneer has read a description of the property, and the conditions on which it is to be disposed of, a piece of candle, usually an inch long, is lighted, and he who is the last bidder at the time the light goes out is declared the purchaser.

Swift, in his *Ballad on the South Sea Scheme*, 1721, did not forget Garraway's:

There is a gulf, where thousands fell,  
Here all the bold adventurers came,  
A narrow sound, though deep as hell,  
'Change alley is the dreadful name.

Subscribers here by thousands float,  
And jostle one another down,  
Each paddling in his leaky boat,  
And here they fish for gold and drown.

Now buried in the depths below,  
Now mounted up to heaven again,  
They reel and stagger to and fro,  
At their wits' end, like drunken men.

Meantime secure on Garway cliffs,  
A savage race, by shipwrecks fed,  
Lie waiting for the founder'd skiffs,  
And strip the bodies of the dead.

Dr. Jno. Radcliff, who was a rash speculator in the South Sea Scheme, was usually planted at a table at Garraway's about Exchange time, to watch the turn of the market; and here he was seated when the footman of his powerful rival, Dr. Edward Hannes, came into Garraway's and inquired by way of a puff, if Dr. H. was there. Dr. Radcliff, who was surrounded with several apothecaries and surgeons that flocked about him, cried out, "Dr. Hannes is not here,"

and desired to know "who wants him?" The fellows' reply was, "such a lord and such a lord"; but he was taken up with the dry rebuke, "No, no, friend, you are mistaken; the Doctor wants those lords." One of Radcliff's ventures was five thousand guineas upon one South Sea project. When he was told at Garraway's that 'twas all lost, "Why," said he, "'tis but going up five thousand pair of stairs more." "This answer," says Tom Brown, "deserved a statue."

Jonathan's Coffee-house was another Change-alley coffee-house, which is described in the *Tatler*, No. 38, as "the general mart of stock-jobbers," and the *Spectator*, No. 1, tells us that he "sometimes passes for a Jew in the assembly of stock-jobbers at Jonathan's." This was their rendezvous, where gambling of all sorts was carried on, notwithstanding a former prohibition against the assemblage of the jobbers, issued by the City of London, which prohibition continued unrepealed until 1825.

The *Spectator*, No. 16, notices some gay frequenters of the Rainbow Coffee-house in Fleet Street: "I have received a letter desiring me to be very satirical upon the little muff that is now in fashion; another informs me of a pair of silver garters buckled below the knee, that have been lately seen at the Rainbow Coffee-house in Fleet Street."

Mr. Moncrieff, the dramatist, used to tell that about 1780, this house was kept by his grandfather, Alexander Moncrieff, when it retained its original title of "The Rainbow Coffee-house."

Nanjo's Coffee-house at the east corner of Inner Temple-lane, No. 17, Fleet-Street, by some confused with Groom's house, No. 16, was the favorite haunt of Lord Thurlow before he dashed into law practice. At this coffee-house a large attendance of professional loungers was attracted by the fame of the punch and the charms of the landlady, which, with the small wits, were duly admired by and at the bar. One evening, the famous cause of Douglas *v.* the Duke of Hamilton was the topic of discussion, when Thurlow being present, it was suggested, half in earnest, to appoint him junior counsel, which was done. This employment brought him acquaintance with the Duchess of Queensberry, who saw at once the value of a man like Thurlow, and recommended Lord Bute to secure him by a silk gown.

Dick's Coffee-house, at No. 8, Fleet-street, (south side, near Temple Bar) was originally "Richard's," named from Richard Torner, or Turner, to whom the house was let in 1680. Richard's was frequented by Cowper, when he lived in the Temple. In his own account of his insanity, Cowper tells us:

"At breakfast I read the newspaper, and in it a letter, which, the further I perused it, the more closely engaged my attention. I cannot now recollect the purport of it; but before I had finished it, it appeared demonstratively true to me that it was a libel or satire upon me. The author appeared to be acquainted with my purpose of self-destruction, and to have written that letter on purpose to secure and hasten the execution of it. My mind, probably, at this time began to be disordered; however it was, I was certainly given to a strong delusion. I said within myself, 'Your cruelty shall be gratified; you

shall have your revenge,' and flinging down the paper in a fit of strong passion, I rushed hastily out of the room; directing my way towards the fields, where I intended to find some house to die in; or, if not, determined to poison myself in a ditch, where I could meet with one sufficiently retired."

Lloyd's Coffee-house was one of the earliest establishments of its kind; it is referred to in a poem printed in the year 1700, called the *Wealthy Shopkeeper, or Charitable Christian*:

Now to Lloyd's Coffee-house he never fails,  
To read the letters, and attend the sales.

In 1710, Steele (*Tatler*, No. 246) dates from Lloyd's his Petition on Coffee-house Orators and Newsvendors. And Addison, in *Spectator*, April 23, 1711, relates this droll incident: "About a week since there happened to me a very odd accident, by reason of one of these my papers of minutes which I had accidentally dropped at Lloyd's Coffee-house, where the auctions are usually kept. Before I missed it, there were a cluster of people who had found it, and were diverting themselves with it at one end of the coffee-house. It had raised so much laughter among them before I observed what they were about, that I had not the courage to own it. The boy of the coffee-house, when they had done with it, carried it about in his hand, asking everybody if they had dropped a written paper; but nobody challenging it, he was ordered by those merry gentlemen who had before perused it, to get up into the auction pulpit, and read it to the whole room, that if anybody would own it they might. The boy accordingly mounted the pulpit, and with a very audible voice read what proved to be minutes, which made the whole coffee-house very merry; some of them concluded it was written by a madman, and others by somebody that had been taking notes out of the *Spectator*. After it was read, and the boy was coming out of the pulpit, the *Spectator* reached his arm out, and desired the boy to give it him; which was done according. This drew the whole eyes of the company upon the *Spectator*; but after casting a cursory glance over it, he shook his head twice or thrice at the reading of it, twisted it into a kind of match, and lighted his pipe with it. 'My profound silence,' says the *Spectator*, 'together with the steadiness of my countenance, and the gravity of my behaviour during the whole transaction, raised a very loud laugh on all sides of me; but as I had escaped all suspicion of being the author, I was very well satisfied, and applying myself to my pipe and the *Postman*, took no further notice of anything that passed about me.'"

The Smyrna Coffee-house in Pall Mall was, in the reign of Queen Anne, famous for "that cluster of wise-heads" found sitting every evening from the left side of the fire to the door. The following announcement in the *Tatler*, No. 78, is amusing: "This is to give notice to all ingenious gentlemen in and about the cities of London and Westminster, who have a mind to be instructed in the noble sciences of music, poetry, and politics, that they repair to the Smyrna Coffee-house, in Pall Mall, betwixt the hours of eight and ten at night, where they may be instructed gratis, with elaborate essays 'by word of mouth,' on all or any of the above-mentioned arts."

St. James's Coffee-house was the famous Whig coffee-house from the time of Queen Anne till late in the reign of George III. It was the last house but one on the south-west corner of St. James's street, and is thus mentioned in No. 1 of the *Tatler*: "Foreign and Domestic News you will have from St. James's Coffee-house." It occurs also in the passage quoted previously from the *Spectator*. The St. James's was much frequented by Swift; letters for him were left here. In his *Journal* to Stella he says: "I met Mr. Harley, and he asked me how long I had learnt the trick of writing to myself? He had seen your letter through the glass case at the Coffee-house, and would swear it was my hand."

To show the order and regularity observed at the St. James's, we may quote the following advertisement, appended to the *Tatler*, No. 25: "To prevent all mistakes that may happen among gentlemen of the other end of the town, who come but once a week to St. James's Coffee-house, either by miscalling the servants, or requiring such things from them as are not properly within their respective provinces, this is to give notice that Kidney, keeper of the book-debts of the outlying customers, and observer of those who go off without paying, having resigned that employment, is succeeded by John Sowton; to whose place of enterer of messages and first coffee-grinder, William Bird is promoted; and Samuel Burdock comes as shoe-cleaner in the room of the said Bird."

But the St. James's is more memorable as the house where originated Goldsmith's celebrated poem, "Retaliation." The poet belonged to a temporary association of men of talent, some of them members of the Club, who dined together occasionally here.

Will's Coffee-house, the predecessor of Button's, and even more celebrated than that coffee-house, was kept by William Urwin. It first had the title of the Red Cow, then of the Rose, and, we believe, is the same house alluded to in the pleasant story in the second number of the *Tatler*. "Supper and friends expect we at the Rose."

Dean Lockier has left this life-like picture of his interview with the presiding genius (Dryden) at Will's.

"I was about seventeen when I first came up to town," says the Dean, "an odd-looking boy, with short rough hair, and that sort of awkwardness which one always brings up at first out of the country with one. However, in spite of my bashfulness and appearance, I used, now and then, to thrust myself into Will's to have the pleasure of seeing the most celebrated wits of that time, who then resorted thither. The second time that ever I was there, Mr. Dryden was speaking of his own things, as he frequently did, especially of such as had been lately published. 'If anything of mine is good,' says he, 'tis "Mac-Flecno," and I value myself the more upon it, because it is the first piece of ridicule written in heroics.' On hearing this I plucked up my spirit so far as to say, in a voice but just loud enough to be heard, "that "Mac-Flecno" was a very fine poem, but that I had not imagined it to be the first that was ever writ that way.' On this, Dryden turned short upon me, as surprised at my interposing; asked me how long 'I had been a dealer in poetry'; and added, with a smile, 'Pray, Sir, what is it that you did imagine to have been

writ so before?'—I named Boileau's 'Lutrin' and Tassoni's 'Secchia Rapita,' which I had read, and knew Dryden had borrowed some strokes from each. 'Tis true,' said Dryden, 'I had forgot them.' A little after, Dryden went out, and in going, spoke to me again, and desired me to come and see him the next day. I was highly delighted with the invitation; went to see him accordingly; and was well acquainted with him after, as long as he lived."

Will's Coffee-house was the open market for libels and lampoons, the latter named from the established burden formerly sung to them:

*Lampone, lampone, camerada lampone.*

There was a drunken fellow, named Julian, who was a characterless frequenter of Will's, and Sir Walter Scott has given this account of him and his vocation:

"Upon the general practice of writing lampoons, and the necessity of finding some mode of dispersing them, which should diffuse the scandal widely while the authors remained concealed, was founded the self-erected office of Julian, Secretary, as he called himself, to the Muses. This person attended Will's, the Wits' Coffee-house, as it was called; and dispersed among the crowds who frequented that place of gay resort copies of the lampoons which had been privately communicated to him by their authors. 'He is described,' says Mr. Malone, 'as a very drunken fellow, and at one time was confined for a libel.'"

Pepys, one night, going to fetch home his wife, stopped in Covent Garden, at the Great Coffee-house there, as he called Will's, where he never was before: "Where," he adds, "Dryden, the poet (I knew at Cambridge), and all the Wits of the town, and Harris the player, and Mr. Hoole of our College. And had I had time then, or could at other times, it will be good coming thither, for there, I perceive, is very witty and pleasant discourse. But I could not tarry, and, as it was late, they were all ready to go away."

Addison passed each day alike, and much in the manner that Dryden did. Dryden employed his mornings in writing, dined *en famille*, and then went to Will's, "only he came home earlier o' nights."

Pope, when very young, was impressed with such veneration for Dryden, that he persuaded some friends to take him to Will's Coffee-house, and was delighted that he could say that he had seen Dryden. Sir Charles Wogan, too, brought up Pope from the Forest of Windsor, to dress *a la mode*, and introduce at Will's Coffee-house. Pope afterwards described Dryden as "a plump man with a down look, and not very conversible," and Cibber could tell no more "but that he remembered him a decent old man, arbiter of critical disputes at Will's." Prior sings of—

The younger Stiles,

Whom Dryden pedagogues at Will's!

Most of the hostile criticism on his Plays, which Dryden has noticed in his various Prefaces, appear to have been made at his favourite haunt, Will's Coffee-house.

Dryden is generally said to have been returning from Will's to his house in Gerard Street, when

he was cudgelled in Rose Street by three persons hired for the purpose by Wilmot, Earl of Rochester, in the winter of 1679.

It is worthy of remark that Swift was accustomed to speak disparagingly of Will's, as in his "Rhapsody on Poetry":

Be sure at Will's the following day  
Lie snug, and hear what critics say;  
And if you find the general vogue  
Pronounces you a stupid rogue,  
Damns all your thoughts as low and little;  
Sit still, and swallow down your spittle.

Swift thought little of the frequenters of Will's: he used to say, the worst conversation he ever heard in his life was at Will's Coffee-house, where the wits (as they were called) used formerly to assemble; that is to say, five or six men who had writ plays or at least prologues, or had a share in a miscellany, came thither, and entertained one another with their trifling composures, in so important an air as if they had been the noblest efforts of human nature, or that the fate of kingdoms depended on them."

In the first number of the *Tatler*, poetry is promised under the article of Will's Coffee-house. The place, however, changed after Dryden's time: "you used to see songs, epigrams, and satires in the hands of every man you met, you have now only a pack of cards; and instead of the cavils about the turn of the expression, the elegance of the style, and the like, the learned now dispute only about the truth of the game." "In old times, we used to sit upon a play here, and after it was acted, but now the entertainment's turned another way."

The *Spectator* is sometimes seen "thrusting his head into a round of politicians at Will's, and listening with great attention to the narratives that are made in these little circular audiences." Then, we have as an instance of no one member of human society but that would have some little pretension for some degree in it, "like him who come to Will's Coffee-house upon the merit of having writ a posie of a ring." And, "Robin, the porter who waits at Will's, is the best man in town for carrying a billet: the fellow has a thin body, swift step, demure looks, sufficient sense, and knows the town."

After Dryden's death, in 1701, Will's continued for about ten years to be still the Wits' Coffee-house, as we see by Ned Ward's account, and by the "Journey through England" in 1722.

Pope entered with keen relish into society, and courted the correspondence of the town wits and coffee-house critics. Among his early friends was Mr. Henry Cromwell, one of the *cousinry* of the Protector's family: he was a bachelor, and spent most of his time in London; he had some pretensions to scholarship and literature, having translated several of Ovid's *Elegies*, for Tonson's *Miscellany*. With Wycherly, Gay Dennis, the popular actors and actresses of the day, and with all the frequenters of Will's, Cromwell was familiar. He had done more than take a pinch out of Dryden's snuff-box, which was a point of high ambition and honor at Will's; he had quarrelled with him about a frail poetess, Mrs. Elizabeth Thomas, whom Dryden had christened *Corinna*, and who was also known as *Sappho*. Gay characterized this literary and eccentric beau as an

Honest, hatless Cromwell, with red breeches:

it being his custom to carry his hat in his hand when walking with ladies. What with ladies and literature, rehearsals and reviews, and critical attention to the quality of his coffee and Brazil snuff, Henry Cromwell's time was fully occupied in town. Cromwell was a dangerous acquaintance for Pope at the age of sixteen or seventeen, but he was a very agreeable one. Most of Pope's letters to his friends are addressed to him at the Blue Hall, in Great Wildstreet, near Drury Lane, and others to "Widow Hambleton's Coffee-house, at the end of Princes-street, near Drury-Lane, London." Cromwell made one visit to Binfield; on his return to London, Pope wrote to him, "referring to the ladies in particular," and to his favorite coffee.

Will's was the great resort for the wits of Dryden's time, after whose death it was transferred to Button's. Pope describes the houses as "opposite each other, in Russell-street, Covent Garden," where Addison established Daniel Button, in a new house, about 1712; and his fame, after the production of *Cato*, drew many of the Whigs thither. Button had been servant to the Countess of Warwick. The house is more correctly described as "over against Tom's near the middle of the south side of the street."

Addison was the great patron of Button's; but it is said that when he suffered any vexation from his Countess, he withdrew from Button's house. His chief companions, before he married Lady Warwick, were Steele, Budgell, Philips, Carey, Davenant, and Colonel Brett. He used to breakfast with one or other of them in St. James's-place, dine at taverns with them, then to Button's, and then to some tavern again, for supper in the evening; and this was the usual round of his life, as Pope tells us in *Spencer's Anecdotes*, where Pope also says: "Addison usually studied all the morning, then met his party at Button's, dined there, and stayed five or six hours; and sometimes far into the night. I was of the company for about a year, but found it too much for me; it hurt my health, and so I quitted it." Again: "There had been a coldness between me and Mr. Addison for some time, and we had not been in company together for a good while anywhere but at Button's Coffee-house, where I used to see him almost every day."

Here Pope is reported to have said of Patrick, the lexicographer, that "a dictionary-maker might know the meaning of one word, but not of two put together."

Button's was the receiving house for contributions to *The Guardian*, for which purpose was put up a lion's head letter box, in imitation of the celebrated lion at Venice, as humorously announced. Thus:

"N. B.—Mr. Ironside has, within five weeks last past, muzzled three lions, gorged five, and killed one. On Monday next the skin of the dead one will be hung up, *in terrorem*, at Button's Coffee-house."

\* \* \*

"I intend to publish once every week the roarings of the Lion, and hope to make him roar so loud as to be heard over all the British nation. I have, I know not how, been drawn into tattle of myself, more majorum, almost the length of a whole *Guardian*. I shall therefore fill up the



remaining part of it with what still relates to my own person, and my correspondents. Now I would have them all know that on the 20th instant, it is my intention to erect a Lion's Head, in imitation of those I have described in Venice, through which all the private commonwealth is said to pass. This head is to open a most wide and voracious mouth, which shall take in such letters and papers as are conveyed to me by my correspondents, it being my resolution to have a particular regard to all such matters as come to my hands through the mouth of the Lion. There will be under it a box, of which the key will be in my own custody, to receive such papers as are dropped into it. Whatever the Lion swallows I shall digest for the use of the publick. This head requires some time to finish, the workmen being resolved to give it several masterly touches, and to represent it as ravenous as possible. It will be set up in Button's Coffee-house, in Covent Garden, who is directed to show the way to the Lion's Head, and to instruct any young author how to convey his works into the mouth of it with safety and secrecy."

"I think myself obliged to acquaint the publick, that the Lion's Head, of which I advertised them about a fortnight ago, is now erected at Button's Coffee-house, in Russell-street, Covent Garden, where it opens its mouth at all hours for the reception of such intelligence as shall be thrown into it. It is reckoned an excellent piece of workmanship, and was designed by a great hand in imitation of the antique Egyptian lion, the face of it being compounded out of that of a lion and a wizard. The features are strong and well furrowed. The whiskers are admired by all that have seen them. It is planted on the western side of the Coffee-house, holding its paws under the chin, upon a box, which contains everything that he swallows. He is, indeed, a proper emblem of knowledge and action, being all head and paws."

"Being obliged, at present, to attend a particular affair of my own, I do empower my printer to look into the arcana of the Lion, and select out of them such as may be of publick utility; and Mr. Button is hereby authorized and commanded to give my said printer free ingress and egress to the lion, without any hindrance, let, or molestation whatsoever, until such time as he shall receive orders to the contrary. And, for so doing, this shall be his warrant."

"My Lion, whose jaws are at all times open to intelligence, informs me that there are a few enormous weapons still in being; but that they are to bet met with only in gaming houses and some of the obscure retreats of lovers, in and about Drury-lane and Covent Garden."

This memorable Lion's Head was tolerably well carved: through the mouth the letters were dropped into a till at Button's; and beneath were inscribed these two lines from Martial:

*Cervantur magnis isti Cervicibus ungues;  
Non nisi delicta pascitur ille fera.*

The head was designed by Hogarth, and is etched in Ireland's *Illustrations*. Lord Chesterfield is said to have once offered for the Head fifty guineas. From Button's it was removed to the Shakspeare's Head Tavern, under the Piazza,

kept by a person named Tomkyns; and in 1751, was, for a short time, placed in the Bedford Coffee-house immediately adjoining the Shakspeare, and there employed as a letter-box by Dr. John Hill, for his *Inspector*. In 1769, Tomkyns was succeeded by his waiter, Campbell, as proprietor of the tavern and lion's head, and by him the latter was retained until November 8, 1804, when it was purchased by Mr. Charles Richardson, of Richardson's Hotel, for 17£ 10s., who also possessed the original sign of the Shakspeare's Head. After Mr. Richardson's death in 1827, the Lion's Head devolved to his son, of whom it was bought by the Duke of Bedford, and deposited at Woburn Abbey, where it still remains.

Pope was subjected to much annoyance and insult at Button's. Sir Samuel Garth wrote to Gay, that everybody was pleased with Pope's Translation, "but a few at Button's"; to which Gay adds, to Pope, "I am confirmed that at Button's your character is made very free with, as to morals, etc."

Cibber, in a letter to Pope, says: "When you used to pass your hours at Button's, you were even there remarkable for your satirical itch of provocation; scarce was there a gentleman of any pretension to wit, whom your unguarded temper had not fallen upon in some biting epigram, among which you once caught a pastoral Tartar, whose resentment, that your punishment might be proportionate to the smart of your poetry, had stuck up a birchen rod in the room, to be ready whenever you might come within reach of it; and at this rate you writ and rallied and writ on, till you rhymed yourself quite out of the coffee-house." The "pastoral Tartar" was Ambrose Philips, who, says Johnson, "hung up a rod at Button's, with which he threatened to chastise Pope."

Pope, in a letter to Craggs, thus explains the affair: "Mr. Philips did express himself with much indignation against me one evening at Button's Coffee-house (as I was told), saying that I was entered into a cabal with Dean Swift and others, to write against the Whig interest, and in particular to undermine his own reputation and that of his friends, Steele and Addison; but Mr. Philips never opened his lips to my face, on this or any like occasion, though I was almost every night in the same room with him, nor ever offered me any indecorum. Mr. Addison came to me a night or two after Philips had talked in this idle manner, and assured me of his disbelief of what had been said, of the friendship we should always maintain, and desired I would say nothing further of it. My Lord Halifax did me the honour to stir in this matter, by speaking to several people to obviate a false aspersion, which might have done me no small prejudice with one party. However, Philips did all he could secretly to continue to report with the Hanover Club, and kept in his hands the subscriptions paid for me to him, as secretary to that Club. The heads of it have since given him to understand, that they take it ill; but (upon the terms I ought to be with such a man) I would not ask him for this money, but commissioned one of the players, his equals, to receive it. This is the whole matter; but as to the secret grounds of this malignity, they will make a very pleasant history when we meet."

Another account says that the rod was hung up at the bar of Button's, and that Pope avoided





#### ALEXANDER POPE AT BUTTON'S COFFEE HOUSE—1730

From drawing by Hogarth. The man opposite the seated figure is thought to be Pope

it by remaining at home—"his usual custom." Philips was known for his courage and superior dexterity with the sword; he afterwards became justice of the peace, and used to mention Pope, whenever he could get a man in authority to listen to him, as an enemy to the Government.

At Button's the leading company, particularly Addison and Steele, met in large flowing flaxen wigs. Sir Godfrey Kneller, too, was a frequenter.

The master died in 1731, when in the *Daily Advertiser*, October 5, appeared the following: "On Sunday morning, died after three days' illness, Mr. Button, who formerly kept Button's Coffee-house, in Russell-street, Covent Garden: a very noted house for wits, being the place where the Lyon produced the famous *Tatlers* and *Spectators*, written by the late Mr. Secretary Addison and Sir Richard Steele, Knt., which works will transmit their names with honour to posterity."

Among other wits who frequented Button's were Swift, Arbuthnot, Savage, Budgell, Martin Folkes, and Drs. Garth and Armstrong. In 1720, Hogarth mentions "four drawings in Indian ink" of the characters at Button's Coffee-house. In these were sketches of Arbuthnot, Addison, Pope (as it is conjectured) and a certain Count Viviani, identified years afterwards by Horace Wal-

pole, when the drawings came under his notice. They subsequently came into Ireland's possession.

Jemmy Maclaine, or M'Clean, the fashionable highwayman, was a frequent visitor at Button's. Mr. John Taylor, of the *Sun* newspaper, describes Maclaine as a tall, showy, good-looking man. A Mr. Donaldson told Taylor that, observing Maclaine paid particular attention to the barmaid of the Coffee-house, the daughter of the landlord, he gave a hint to the father of Maclaine's dubious character. The father cautioned the daughter against the highwayman's addresses, and imprudently told her by whose advice he put her on her guard; she as imprudently told Maclaine. The next time Donaldson visited the coffee-room, and sitting in one of the boxes, Maclaine entered, and in a loud tone said, "Mr. Donaldson, I wish to *spake* to you in a private room." Mr. D. being unarmed, and naturally afraid of being alone with such a man, said, in answer, that as nothing could pass between them that he did not wish the whole world to know, he begged leave to decline the invitation. "Very well," said Maclaine, as he left the room, "we shall meet again." A day or two after, as Mr. Donaldson was walking near Richmond, in the evening, he saw Maclaine on horseback; but fortunately, at that moment, a gentleman's carriage appeared in view, when Maclaine immediately turned his horse

towards the carriage, and Donaldson hurried into the protection of Richmond as fast as he could. But for the appearance of the carriage, which presented better prey, it is possible that Maclaine would have shot Mr. Donaldson immediately.

Maclaine's father was an Irish dean; his brother was a Calvinist minister in great esteem at the Hague. Maclaine himself had been a grocer in Welbeck-street, but losing a wife that he loved extremely, and by whom he had one little girl, he quitted his business with two hundred pounds in his pockets which he soon spent, and then took to the road with only one companion, Plunket, a journeyman apothecary.

Maclaine was taken in the autumn of 1750, by selling a laced waistcoat to a pawnbroker in Monmouth-street, who happened to carry it to the very man who had just sold the lace. Maclaine impeached his companion, Plunket, but he was not taken. The former got into verse: Gray, in his "Long Story," sings:

As sudden fit of ague shook him;  
He stood as mute as poor M'Lean.

Button's subsequently became a private house, and here Mrs. Inchbald lodged, probably, after the death of her sister, for whose support she practised such noble and generous self-denial. Mrs. Inchbald's income was now 172£ a year, and we are told that she now went to reside in a boarding-house, where she enjoyed more of the comforts of life. Phillips, the publisher, offered her a thousands pounds for her *Memoirs*, which she declined. She died in a boarding-house at Kensington, on the 1st of August, 1821, leaving about 6,000£ judiciously divided amongst her relatives. Her simple and parsimonious habits were very strange. "Last Thursday," she writes, "I finished scouring my bedroom, while a coach with a coronet and two footmen waited at my door to take me an airing."

"One of the most agreeable memories connected with Button's," says Leigh Hunt, "is that of Garth, a man whom, for the sprightliness and generosity of his nature, it is a pleasure to name. He was one of the most amiable and intelligent of a most amiable and intelligent class of men—the physicians."

It was just after Queen Anne's accession that Swift made acquaintance with the leaders of the wits at Button's. Ambrose Philips refers to him as the strange clergyman whom the frequenters of the Coffee-house had observed for some days. He knew no one, no one knew him. He would lay his hat down on a table, and walk up and down at a brisk pace for half an hour without speaking to any one, or seeming to pay attention to anything that was going forward. Then he would snatch up his hat, pay his money at the bar, and walk off, without having opened his lips. The frequenters of the room had christened him "the mad parson." One evening, as Mr. Addison and the rest were observing him, they saw him cast his eyes several times upon a gentleman in boots, who seemed to be just come out of the country. At last, Swift advanced towards this bucolic gentleman, as if intending to address him. They were all eager to hear what the dumb parson had to say, and immediately quitted their seats to get near him. Swift went up to the country gentleman, and in a very abrupt manner, without any previous salute, asked him, "Pray,

Sir, do you know any good weather in the world?" After staring a little at the singularity of Swift's manner and the oddity of the question, the gentleman answered, "Yes, Sir, I thank God I remember a great deal of good weather in my time."—"That is more," replied Swift, "than I can say; I never remember any weather that was not too hot or too cold, too wet or too dry; but, however God Almighty contrives it, at the end of the year 'tis all very well."

Sir Walter Scott gives, upon the authority of Dr. Wall, of Worcester, who had it from Dr. Arbuthnot himself, the following anecdote—less coarse than the version generally told. Swift was seated by the fire at Button's; there was sand on the floor of the coffee-room, and Arbuthnot, with a design to play upon this original figure, offered him a letter, which he had been just addressing, saying at the same time, "There—sand that"—"I have got no sand," answered Swift, "but I can help you to a little gravel." This he said so significantly, that Arbuthnot hastily snatched back his letter, to save it from the fate of the capital of Lilliput.

Tom's Coffee-house in Birchin-lane, Cornhill, though in the main a mercantile resort, acquired some celebrity from its having been frequented by Garrick, who, to keep up an interest in the City, appeared here about twice in a winter at 'Change time, when it was the rendezvous of young merchants.

Hawkins says: "After all that has been said of Mr. Garrick, envy must own that he owed his celebrity to his merit; and yet, of that himself so diffident, that he practiced sundry little but innocent arts, to insure the favour of the public:" yet, he did more. When a rising actor complained to Mrs. Garrick that the newspapers abused him, the widow replied, "You should write your own criticisms; David always did."

One evening, Murphy was at Tom's, when Colley Cibber was playing at whist, with an old general for his partner. As the cards were dealt to him, he took up every one in turn, and expressed his disappointment at each indifferent one. In the progress of the game he did not follow suit, and his partner said, "What! have you not a spade, Mr. Cibber?" The latter, looking at his cards, answered, "Oh, yes, a thousand;" which drew a very peevish comment from the general. On which, Cibber, who was shockingly addicted to swearing, replied, "Don't be angry, for—I can play ten times worse if I like."

The celebrated Bedford Coffee-house, in Covent Garden, once attracted so much attention as to have published, "Memoirs of the Bedford Coffee-house," two editions, 1751 and 1763. It stood "under the Piazzis, in Covent Garden," in the north-west corner, near the entrance to the theatre, and has long ceased to exist.

In the *Connoisseur*, No. 1, 1754, we are assured that "this Coffee-house is every night crowded with men of parts. Almost every one you meet is a polite scholar and a wit. Jokes and bon-mots are echoed from box to box: every branch of literature is critically examined, and the merit of every production of the press, or performance of the theatres, weighed and determined."

And in the above-named "Memoirs" we read that "this spot has been signalized for many years as the emporium of wit, the seat of criticism, and

the standard of taste.—Names of those who frequented the house: Foote, Mr. Fielding, Mr. Woodward, Mr. Leone, Mr. Murphy, Mopsy, Dr. Arne. Dr. Arne was the only man in a suit of velvet in the dog-days."

Stacie kept the Bedford when John and Henry Fielding, Hogarth, Churchill, Woodward, Lloyd, Dr. Goldsmith and many others met there and held a gossiping shilling rubber club. Henry Fielding was a very smart fellow.

The *Inspector* appears to have given rise to this reign of the Bedford, when there was placed here the Lion from Button's, which proved so serviceable to Steele, and once more fixed the dominion of wit in Covent Garden.

The reign of wit and pleasantry did not, however, cease at the Bedford at the demise of the *Inspector*. A race of punsters next succeeded. A particular box was allotted to this occasion, out of hearing of the lady of the bar, that the *double entendres*, which were sometimes very indelicate, might not offend her.

The Bedford was beset with scandalous nuisances, of which the following letter, from Arthur Murphy to Garrick, April 10, 1768, presents a pretty picture:

"Tiger Roach (who used to bully at the Bedford Coffee-house because his name was Roach) is set up by Wilke's friends to burlesque Luttrell and his pretensions. I own I do not know a more ridiculous circumstance than to be a joint candidate with the Tiger. O'Brien used to take him off very pleasantly, and perhaps you may, from his representation, have some idea of this important wight. He used to sit with a half-starved look, a black patch upon his cheek, pale with the idea of murder, or with rank cowardice, a quivering lip, and a downcast eye. In that manner he used to sit at a table all alone, and his soliloquy, interrupted now and then with faint attempts to throw off a little saliva, was to the following effect:—'Hut! hut! a mercer's 'prentice with a bag-wig; —d—n my s—l, if I would not skiver a dozen of them like larks! Hut! hut! I don't understand such airs!—I'd cudgel him back, breast and belly, for three skips of a louse!—How do you do, Pat? Hut! hut! God's blood—Larry, I'm glad to see you; 'Prentices! a fine thing indeed!—Hut! hut! How do you do, Dominick!—D—n my s—l, what's here to do!' These were the meditations of this agreeable youth. From one of these reveries he started up one night, when I was there, called a Mr. Bagnell out of the room, and most heroically stabbed him in the dark, the other having no weapon to defend himself with. In this career, the Tiger persisted, till at length a Mr. Lennard brandished a whip over his head, and stood in a menacing attitude, commanding him to ask pardon directly. The Tiger shrank from the danger, and with a faint voice pronounced—'Hut! what signifies it between you and me? Well! well! I ask your pardon.' 'Speak louder, Sir; I don't hear a word you say.' And indeed he was so very tall, that it seemed as if the sound, sent feebly from below, could not ascend to such a height. This is the hero who is to figure at Brentford."

Foote's favourite coffee-house was the Bedford. He was also a constant frequenter of Tom's, and took a lead in the Club held there, and already described.

Dr. Barrowby, the well-known newsmonger of

the Bedford, and the satirical critic of the day, has left this whole-length sketch of Foote:

"One evening (he says) he saw a young man extravagantly dressed out in a frock suit of green and silver lace, bag-wig, sword, bouquet, and point ruffles, enter the room (at the Bedford), and immediately join the critical circle at the upper end. Nobody recognized him; but such was the ease of his bearing, and the point of humor and remark with which he at once took up the conversation, that his presence seemed to disconcert no one, and a sort of pleased buzz of 'who is he?' was still going round the room unanswered, when a handsome carriage stopped at the door; he rose, and quitted the room, and the servants announced that his name was Foote, and that he was a young gentleman of family and fortune, a student of the Inner Temple, and that the carriage had called for him on its way to the assembly of a lady of fashion." Dr. Barrowby once turned the laugh against Foote at the Bedford, when he was ostentatiously showing his gold repeater, with the remark—"Why, my watch does not go!" "It soon *will* go," quietly remarked the Doctor. Young Collins, the poet, who came to town in 1744 to seek his fortune, made his way to the Bedford, where Foote was supreme among the wits and critics. Like Foote, Collins was fond of fine clothes, and walked about with a feather in his hat, very unlike a young man who had not a single guinea he could call his own. A letter of the time tells us that "Collins was an acceptable companion everywhere; and among the gentlemen who loved him for a genius, may be reckoned the Doctors Armstrong, Barrowby, Hill, Messrs. Quin, Garrick, and Foote, who frequently took his opinions upon their pieces before they were seen by the public. He was particularly noticed by the geniuses who frequented the Bedford and Slaughter's Coffee-houses."

Ten years later (1754) we find Foote again supreme in his critical corner at the Bedford. The regular frequenters of the room strove to get admitted to his party at supper; and others got as near as they could to the table, as the only humor flowed from Foote's tongue. The Bedford was now in its highest repute.

Foote and Garrick often met at the Bedford, and many and sharp were their encounters. They were the two great rivals of the day. Foote usually attacked, and Garrick, who had many weak points, was mostly the sufferer. Garrick, in early life, had been in the wine trade, and had supplied the Bedford with wine; he was thus described by Foote as living in Durham-yard, with three quarts of vinegar in the cellar, calling himself a wine-merchant. How Foote must have abused the Bedford wine of this period!

One night, Foote came into the Bedford, where Garrick was seated, and there gave him an account of a most wonderful actor he had just seen. Garrick was on the tenters of suspense, and there Foote kept him a full hour. Foote brought the attack to a close by asking Garrick what he thought of Mr. Pitt's histrionic talents, when Garrick, glad of the release, declared that if Pitt had chosen the stage, he might have been the first actor upon it.

Another night, Garrick and Foote were about to leave the Bedford together, when the latter, in paying the bill, dropped a guinea; and not finding it at once, said, "Where on earth can it

be gone to?"—"Gone to the devil, I think," replied Garrick, who had assisted in the search.—"Well said, David!" was Foote's reply, "let you alone for making a guinea go further than anybody else."

Churchill's quarrel with Hogarth began at the shilling rubber club, in the parlour of the Bedford; when Hogarth used some very insulting language towards Churchill, who resented it in the *Epistle*. This quarrel showed more venom than wit. "Never," says Walpole, "did two angry men of their abilities throw mud with less dexterity."

Woodward, the comedian, mostly lived at the Bedford, was intimate with Stacie, the landlord, and gave him his (W.'s) portrait, with a mask in his hand, one of the early pictures by Sir Joshua Reynolds. Stacie played an excellent game at whist. One morning about two o'clock, one of the waiters awoke him to tell him that a nobleman had knocked him up, and had desired him to call his master to play a rubber with him for one hundred guineas. Stacie got up, dressed himself, won the money, and was in bed and asleep, all within an hour.

After Macklin had retired from the stage, in 1754, he opened that portion of the Piazza-houses, in Covent Garden, afterwards known as the Tavistock Hotel. Here he fitted up a large coffee-room, a theatre for oratory, and other apartments. To a three-shilling ordinary he added a shilling lecture, or "School of Oratory and Criticism"; he presided at the dinner table, and carved for the company; after which he played a sort of "Oracle of Eloquence." Fielding has happily sketched him in his "Voyage to Lisbon": "Unfortunately for the fishmongers of London, the Dory only resides in the Devonshire seas; for could any of this company only convey one to the Temple of luxury under the piazza, where Macklin, the high priest, daily serves up his rich offerings, great would be the reward of that fishmonger."

In the Lecture, Macklin undertook to make each of his audience an orator, by teaching him how to speak. He invited hints and discussions; the novelty of the scheme attracted the curiosity of numbers; and this curiosity he still further excited by a very uncommon controversy which now subsisted, either in imagination or reality, between him and Foote, who abused one another very openly—"Squire Sammy," having for his purpose engaged the Little Theatre in the Haymarket.

Besides this personal attack, various subjects were debated here in the manner of the Robin Hood Society, which filled the Orator's pocket, and proved his rhetoric of some value.

Here is one of his combats with Foote. The subject was Duelling in Ireland, which Macklin had illustrated as far as the reign of Elizabeth. Foote cried, "Order"; he had a question to put. "Well, Sir," said Macklin, "what have you to say on this subject?" "I think, Sir," said Foote, "this matter might be settled in a few words. What o'clock is it, Sir?" Macklin could not possibly see what the clock had to do with a dissertation upon Duelling, but gruffly reported the hour to be half-past nine. "Very well," said Foote, "about this time of the night every gentleman in Ireland that can possibly afford it is in his third bottle of claret, and therefore in a fair way, of getting drunk; and from drunkenness pro-

ceeds quarrelling, and from quarrelling, duelling, and so there's an end of the chapter." The company were much obliged to Foote for his interference, the hour being considered; though Macklin did not relish this abridgement.

The success of Foote's fun upon Macklin's Lectures, led him to establish a summer entertainment of his own at the Haymarket. He took up Macklin's notion of applying Greek tragedy to modern subjects, and the squib was so successful that Foote cleared by it 500£ in five nights, while the great Piazza Coffee-room in Covent Garden was shut up, and Macklin in the *Gazette* as a bankrupt.

But when the great plan of Mr. Macklin proved abortive, when as he said in a former prologue, upon a nearly similar occasion—

From scheming, fretting, famine and despair,  
We saw to grace restor'd an exiled player;  
when the town was sated with the seemingly-concocted quarrel between the two theatrical geniuses, Macklin locked his doors, all animosity was laid aside, and they came and shook hands at the Bedford; the group resumed their appearance, and, with a new master, a new set of customers was seen.

Tom King's Coffee-house was one of the old night-houses of Covent Garden Market; it was a rude shed immediately beneath the portico of St. Paul's Church, and was one "well known to all gentlemen to whom beds are unknown." Fielding in one of his Prologues says:

What rake is ignorant of King's Coffee-house?  
It is in the background of Hogarth's print of *Morning* where the prim maiden lady, walking to church, is soured with seeing two fuddled *beaux* from King's Coffee-house caressing two frail women. At the door there is a drunken row, in which swords and cudgels are the weapons.<sup>10</sup>

Harwood's *Alumni Etonenses*, p. 239, in the account of the Boys elected from Eton to King's College, contains this entry: "A. D. 1713, Thomas King, born at West Ashton, in Wiltshire, went away scholar in apprehension that his fellowship would be denied him; and afterwards kept that Coffee-house in Covent Garden, which was called by his own name."

Moll King was landlady after Tom's death: she was witty, and her house was much frequented, though it was little better than a shed. "Noblemen and the first *beaux*," said Stacie, "after leaving Court would go to her house in full dress, with swords and bags, and in rich brocaded silk coats, and walked and conversed with persons of every description. She would serve chimney-sweepers, gardeners, and the market-people in common with her lords of the highest rank. Mr. Apreece, a tall thin man in rich dress, was her constant customer. He was called Cadwallader by the frequenters of Moll's." It is not surprising that Moll was often fined for keeping a disorderly house. At length, she retired from business—and the pillory—to Hempstead, where she lived on her ill-earned gains, but paid for a pew in church, and was charitable at appointed seasons, and died in peace in 1747.

The Piazza Coffee-house at the north-eastern angle of Covent Garden Piazza, appears to have originated with Macklin's; for we read in an advertisement in the *Publick Adviser*, March 5,

<sup>10</sup> See Chapter XXXVIII.

1756: "The Great Piazza Coffee-room, in Covent Garden."

The Piazza was much frequented by Sheridan; and here is located the well-known anecdote told of his coolness during the burning of Drury-lane Theatre, in 1809. It is said that as he sat at the Piazza, during the fire, taking some refreshment, a friend of his having remarked on the philosophical calmness with which he bore his misfortune, Sheridan replied:

"A man may surely be allowed to take a glass of wine by his *own fireside*."

Sheridan and John Kemble often dined together at the Piazza, to be handy to the theatre. During Kemble's management, Sheridan had occasion to make a complaint, which brought a "nervous" letter from Kemble, to which Sheridan's reply is amusing enough. Thus, he writes: "that the management of a theatre is a situation capable of becoming *troublesome*, is information which I do not want, and a discovery which I thought you made long ago." Sheridan then treats Kemble's letter as "a nervous flight," not to be noticed seriously, adding his anxiety for the interest of the theatre, and alluding to Kemble's touchiness and reserve; and thus concludes:

"If there is anything amiss in your mind not arising from the *troublesomeness* of your situation, it is childish and unmanly not to disclose it. The frankness with which I have dealt towards you entitles me to expect that you should have done so.

"But I have no reason to believe this to be the case; and attributing your letter to a disorder which I know ought not to be indulged, I prescribe that thou shalt keep thine appointment at the Piazza Coffee-house, tomorrow at five, and, taking four bottles of claret instead of three, to which in sound health you might stint yourself, forget that you ever wrote the letter, as I shall that I ever received it.

"R. B. Sheridan."

The Piazza facade, and interior, were of Gothic design. When the house was demolished, in its place was built the Floral Hall, after the Crystal Palace model.

The Chapter Coffee-house was a literary place of resort in Paternoster Row, more especially in connection with the Wittinagemot of the last century. A very interesting account of the Chapter, at a later period (1848) is given by Mrs. Gaskell.

Goldsmith frequented the Chapter, and always occupied one place, which for many years after was the seat of literary honor there. There are leather tokens of the Chapter Coffee-house in existence.

Child's Coffee-house, in St. Paul's Churchyard, was one of the *Spectator's* houses. "Sometimes," he says, "I smoke a pipe at Child's and whilst I seem attentive to nothing but the *Postman*, overhear the conversation of every table in the room." It was much frequented by the clergy; for the *Spectator*, No. 609, notices the mistake of a country gentleman in taking all persons in scarfs for Doctors of Divinity, since only a scarf of the first magnitude entitles him to "the appellation of Doctor from his landlady and the *Boy at Child's*."

Child's was the resort of Dr. Mead, and other professional men of eminence. The Fellows of the Royal Society came here. Whiston relates

that Sir Hans Sloane, Dr. Halley and he were once at Child's when Dr. H. asked him, W., why he was not a member of the Royal Society? Whiston answered, because they durst not choose a heretic. Upon which Dr. H. said, if Sir Hans Sloane would propose him, W., he, Dr. H., would send it, which was done accordingly.

The propinquity of Child's to the Cathedral and Doctors' Commons, made it the resort of the clergy, and ecclesiastical loungers. In that respect, Child's was superseded by the Chapter, in Paternoster Row.

The London Coffee-house was established previous to the year 1731, for we find of it the following advertisement:

"May, 1731.

"Whereas, it is customary for Coffee-houses and other Public-houses, to take 8s. for a quart of Arrack, and 6s. for a quart of Brandy or Rum, made into Punch:

"This is to give notice,

"That James Ashley has opened on Ludgate Hill, the London Coffee-house, Punch-house, Dorchester Beer and Welsh Ale Warehouse, where the finest and best old Arrack, Rum and French Brandy is made into Punch, with the other of the finest ingredients—viz., A quart of Arrack made into Punch for six shillings; and so in proportion to the smallest quantity, which is half-a-quartern for fourpence half-penny. A quart of Rum or Brandy made into Punch for four shillings; and so in proportion to the smallest quantity, which is half-a-quartern for fourpence half-penny; and gentlemen may have it as soon made as a gill of Wine can be drawn."

The premises occupied a Roman site; for, in 1800, in the rear of the house, in a bastion of the City Wall, was found a sepulchral monument dedicated to Claudina Martina by her husband, a provincial Roman soldier; here also were found a fragment of a statue of Hercules and a female head. In front of the Coffee-house immediately west of St. Martin's Church, stood Ludgate.

The London Coffee-house was noted for its publishers' sales of stock and copyrights. It was within the rules of the Fleet prison; and in the Coffee-house were "locked up" for the night such juries from the Old Bailey Sessions, as could not agree upon verdicts. The house was long kept by the grandfather and father of Mr. John Leech, the celebrated artist.

A singular incident occurred at the London Coffee-house, many years since: Mr. Brayley, the topographer, was present at a party here, when Mr. Broadhurst, the famous tenor, by singing a high note, caused a wine-glass on the table to break, the bowl being separated from the stem.

From *The Kingdom's Intelligencer*, a weekly paper, published by authority, in 1662, we learn that there had just been opened a "new coffee-house," with the sign of the Turk's Head, where was sold by retail "the right coffee-powder," from 4s. to 6s. 8d. per pound; that pounded in a mortar, 2s.; East Indian berry, 1s. 6d.; and the right Turkie berry, well garbled, at 3s. "The ungarbled for lesse, with directions how to use the same." Also Chocolate at 2s. 6d. per pound; the perfumed from 4s. to 10s.; "also, Sherbets made in Turkie, of lemons, roses and violets perfumed; and Tea, or Chaa, according to its goodness. The house seal is Morat the Great. Gentlemen customers and acquaintances are (the next



New Year's Day) invited to the sign of the Great Turk at this new Coffee-house, where Coffee will be on free cost." Morat figures as a tyrant in Dryden's "Aurung Zebe." There is a token of this house, with the sultan's head, in the Beaufoy collection.<sup>11</sup>

Another token in the same collection, is of unusual excellence, probably by John Roettier. It has on the obverse, Morat ye Great Men did mee call,—Sultan's head; reverse, Where eare I came I conquered all.—In the field, Coffee, Tobacco, Sherbet, Tea, Chocolate, retail in Exchange Ale. "The word Tea," says Mr. Burn, "occurs on no other tokens than those issued from 'the Great Turk' Coffee-house, in Exchange alley"; in one of its advertisements, 1662, tea is from 6s. to 60s. a pound.

Competition arose. One Constantine Jennings in Threadneedle-street, over against St. Christopher's Church, advertised that coffee, chocolate, sherbet, and tea, the right Turkey berry, may be had as cheap and as good of him as is anywhere to be had for money; and that people may there be taught to prepare the said liquors gratis.

Pepys, in his "Diary," tells, September 25, 1669, of his sending for "a cup of Tea, a China Drink, he had not before tasted." Henry Bennet, Earl of Arlington, about 1666, introduced tea at Court. And, in his "Sir Charles Sedley's Mulberry Garden," we are told that "he who wished to be considered a man of fashion always drank wine-and-water at dinner, and a dish of tea afterwards." These details are condensed from Mr. Burn's excellent "Beaufoy Catalogue," 2nd edition, 1855.

In Gerard-street, Soho, also, was another Turk's Head Coffee-house, where was held a Turk's Head Society; in 1777, we find Gibbon writing to Garrick: "At this time of year (August 14) the Society of the Turk's Head can no longer be addressed as a corporate body, and most of the individual members are probably dispersed: Adam Smith; in Scotland; Burke in the shades of Beaconsfield; Fox, the Lord or the devil knows where."

The place was a kind of headquarters for the Loyal Association during the Rebellion of 1745. Here was founded "The Literary Club" and a select body for the Protection and Encouragement of Art. Another Society of Artists met in Peter's-court, St. Martin's-lane, from the year 1739 to 1769. After continued squabbles, which lasted for many years, the principal artists met together at the Turk's Head, where many others having joined them, they petitioned the King (George III) to become patron of a Royal Academy of Art. His Majesty consented; and the new Society took a room in Pall Mall, opposite to Market-lane, where they remained until the King, in the year 1771, granted them apartments in Old Somerset House.

The Turk's Head Coffee-house, No. 142, in the Strand, was a favourite supping-house with Dr. Johnson and Boswell, in whose Life of Johnson are several entries, commencing with 1763—"At night, Mr. Johnson and I supped in a private room at the Turk's Head Coffee-house, in the Strand; 'I encourage this house,' said he, 'for the mistress of it is a good civil woman, and has not much business.'" Another entry is—"We con-

cluded the day at the Turk's Head Coffee-house very socially." And, August 3, 1673—"We had our last social meeting at the Turk's Head Coffee-house, before my setting out for foreign parts."

The name was afterwards changed to "The Turk's Head, Canada and Bath Coffee-house," and was a well frequented tavern and hotel.

At the Turk's Head, or Miles's Coffee-house, New Palace-yard, Westminster, the noted Rota Club met, founded by Harrington, in 1659; where was a large oval table, with a passage in the middle, for Miles to deliver his coffee.<sup>12</sup>

For many years previous to the streets of London being completely paved, "Slaughter's Coffee-house" was called "The Coffee-house on the Pavement." Besides being the resort of artists, Old Slaughter's was the house of call for Frenchmen.

St. Martin's-lane was long one of the headquarters of the artists of the last century. "In the time of Benjamin West," says J. T. Smith, "and before the formation of the Royal Academy, Greek-street, St. Martin's-lane, and Gerard-street, was their only colony. Old Slaughter's Coffee-house, in St. Martin's-lane, was their grand resort in the evenings, and Hogarth was a constant visitor." He lived at the Golden Head, on the eastern side of Leicester Fields, in the northern half of the Sabloniere Hotel. The head he cut out himself from pieces of cork, glued and bound together; it was placed over the street-door. At this time, young Benjamin West was living in chambers, in Bedford-street, Covent Garden, and had there set up his easel; he was married in 1765, at St. Martin's Church. Roubiliac was often to be found at Slaughter's in early life; probably before he gained the patronage of Sir Edward Walpole, through finding and returning to the baronet the pocket-book of bank-notes which the young maker of monuments had picked up in Vauxhall Gardens. Sir Edward, to remunerate his integrity, and his skill, of which he showed specimens, promised to patronize Roubiliac through life, and he faithfully performed this promise. Young Gainsborough, who spent three years amid the works of the painters in St. Martin's-lane, Hayman, and Cipriani, who were all eminently convivial, were, in all probability, frequenters of Slaughter's. Smith tells us that Quin and Hayman were inseparable friends, and so convivial, that they seldom parted till daylight.

Mr. Cunningham relates that here, "in early life, Wilkie would enjoy a small dinner at a small cost. I have been told by an old frequenter of the house, that Wilkie was always the last dropper-in for dinner, and that he was never seen to dine in the house by daylight. The truth is, he slaved at his art at home till the last glimpse of daylight had disappeared."

Haydon was accustomed, in the early days of his fitful career, to dine here with Wilkie. In his "Autobiography," in the year 1808, Haydon writes: "This period of our lives was one of great happiness; painting all day, then dining at the Old Slaughter Chop-house, then going to the Academy until eight, to fill up the evening, then going home to tea—that blessing of a studious man—talking over respective exploits, what he, Wilkie, had been doing and what I had been doing, and, then frequently to relieve our minds

<sup>11</sup> See Chapter IX.

<sup>12</sup> See Chapter IX.

fatigued by their eight and twelve hours' work, giving vent to the most extraordinary absurdities. Often have we made rhymes on odd names, and shouted with laughter at each new line that was added. Sometimes lazily inclined after a good dinner, we have lounged about, near Drury Lane or Covent Garden, hesitating whether to go in, and often have I (knowing first that there was nothing I wished to see) assumed a virtue I did not possess, and pretending moral superiority, preached to Wilkie on the weakness of not resisting such temptations for the sake of our art and our duty, and marched him off to his studies, when he was longing to see Mother Goose."

J. T. Smith refers to Old Slaughter's as "formerly the rendezvous of Pope, Dryden and other wits, and much frequented by several eminently clever men of his day."

Thither came Ware, the architect, who, when a little sickly boy, was apprenticed to a chimney-sweeper, and was seen chalking the street-front of Whitehall, by a gentleman who purchased the remainder of the boy's time; gave him an excellent education; then sent him to Italy, and, upon his return, employed him, and introduced him to his friends as an architect. Ware was heard to tell this story while he was sitting to Roubiliac for his bust. Ware built Chesterfield House and several other noble mansions, and compiled a Palladio, in folio: he retained the soot in his skin to the day of his death. He was very intimate with Roubiliac, who was an opposite eastern neighbour of Old Slaughter's. Another architect, Gwynn, who competed with Mylne for designing and building Blackfriars Bridge, was also a frequent visitor at Old Slaughter's, as was Gravelot, who kept a drawing-school in the Strand, nearly opposite to Southampton-street.

Hudson, who painted the Dilettanti portraits; M'Ardell, the mezzotinto-scraper; and Luke Sullivan, the engraver of Hogarth's March to Finchley, also frequented Old Slaughter's; likewise Theodore Gardell, the portrait painter, who was executed for the murder of his landlady; and Old Moser, keeper of the Drawing Academy in Peter's-court.

Parry, the Welsh harper, though totally blind, was one of the first draught-players in England, and occasionally played with the frequenters of Old Slaughter's; and here in consequence of a bet, Roubiliac introduced Nathaniel Smith (father of John Thomas), to play at draughts with Parry; the game lasted about half an hour: Parry was much agitated, and Smith proposed to give in; but as there were bets depending, it was played out, and Smith won. This victory brought Smith numerous challenges; and the dons of the Barn, a public-house, in St. Martin's-lane, nearly opposite the church, invited him to become a member; but Smith declined. The Barn, for many years, was frequented by all the noted players of chess and draughts; and it was there that they often decided games of the first importance, played between persons of the highest rank.

The Grecian Coffee-house, Devereux-court, Strand, (closed in 1843) was named from Constantine, of Threadneedle street, the *Grecian* who kept it. In the *Tatler* announcement, all accounts of learning are to be "under the title of the Grecian"; and, in the *Tatler*, No. 6: "While other parts of the town are amused with the

present actions (Marlborough's) we generally spend the evening at this table (at the Grecian) in inquiries into antiquity, and think anything new, which gives us new knowledge. Thus, we are making a very pleasant entertainment to ourselves in putting the actions of Homer's Iliad into an exact journal."

The *Spectator's* face was very well known at the Grecian, a coffee-house "adjacent to the law." Occasionally it was the scene of learned discussion. Thus Dr. King relates that one evening, two gentlemen, who were constant companions, were disputing here, concerning the accent of a Greek word. This dispute was carried to such a length, that the two friends thought proper to determine it with their swords; for this purpose they stepped into Devereux-court, where one of them (Dr. King thinks his name was Fitzgerald) was run through the body, and died on the spot.

The Grecian was Foote's morning lounge. It was handy, too, for the young Templar, Goldsmith, and often did it echo with Oliver's boisterous mirth; for "it had become the favourite resort of the Irish and Lancashire Templars, whom he delighted in collecting around him, in entertaining with a cordial and unostentatious hospitality, and in occasionally amusing with his flute, or with whist, neither of which he played very well!" Here Goldsmith occasionally wound up his "Shoemaker's Holiday" with supper.

It was at the Grecian that Fleetwood Shephard told this memorable story to Dr. Tancred Robinson, who gave Richardson permission to repeat it. "The Earle of Dorset was in Little Britain, beating about for books to his taste: there was 'Paradise Lost.' He was surprised with some passages he struck upon, dipping here and there and bought it; the bookseller begged him to speak in his favour, if he liked it, for they lay on his hands as waste paper. Shephard was present. My Lord took it home, read it, and sent it to Dryden, who in a short time returned it. 'This man,' says Dryden, 'cuts us all out, and the ancients, too!'"

George's Coffee-house, No. 213, Strand, near Temple Bar, was a noted resort in the eighteenth and nineteenth centuries. When it was a coffee-house, one day, there came in Sir James Lowther, who after changing a piece of silver with the coffee-woman, and paying twopence for his dish of coffee, was helped into his chariot, for he was very lame and infirm, and went home: some little time afterwards, he returned to the same coffee-house, on purpose to acquaint the woman who kept it, that she had given him a bad half-penny, and demanded another in exchange for it. Sir James had about 40,000£ per annum.

Shenstone, who found "the warmest welcome at an inn," found George's to be economical. "What do you think," he writes, "must be my expense, who love to pry into everything of the kind? Why, truly one shilling. My company goes to George's Coffee-house, where, for that small subscription I read all pamphlets under a three shillings' dimension; and indeed, any larger would not be fit for coffee-house perusal." Shenstone relates that Lord Oxford was at George's, when the mob, that were carrying his Lordship in effigy, came into the box where he was, to beg money of him, amongst others; this story Horace

Walpole contradicts, adding that he supposes Shenstone thought that after Lord Oxford quitted his place he went to the coffee-house to learn news.

Arthur Murphy frequented George's, "where the town wits met every evening." Lloyd, the law-student, sings:

By law let others toil to gain renown!  
Florio's a gentleman, a man o' the town.  
He nor courts clients, or the law regarding,  
Hurries from Nando's down to Covent Garden.  
Yet, he's a scholar; mark him in the pit,  
With critic catcall sound the stops of wit!  
Supreme at George's, he harangues the throng,  
Censor of style, from tragedy to song.

The Percy Coffee-house, Rathbone-place, Oxford-street, no longer exists; but it will be kept in recollection for its having given name to one of the most popular publications of its class, namely, the *Percy Anecdotes*, by Sholto and Reuben Percy, Brothers of the Benedictine Monastery of Mont Bengier, in forty-four parts, commencing in 1820. So said the title pages, but the names and the locality were *supposé*. Reuben Percy was Thomas Byerley, who died in 1824; he was the brother of Sir John Byerley, and the first editor of the *Mirror*, commenced by John Limbird, in 1822. Sholto Percy was Joseph Clinton Robertson, who died in 1852; he was the projector of the *Mechanics' Magazine*, which he edited from its commencement to his death. The name of the collection of Anecdotes was not taken, as at the time supposed, from the popularity of the *Percy Reliques*, but from the Percy Coffee-house, where Byerley and Robertson were accustomed to meet to talk over their joint work. The *idea* was, however, claimed by Sir Richard Phillips, who stoutly maintained that it originated in a suggestion made by him to Dr. Tilloch and Mr. Mayne, to cut the anecdotes from the many years' files of the *Star* newspaper, of which Dr. Tilloch was the editor; and Mr. Byerley assistant editor; and to the latter overhearing the suggestion, Sir Richard contested, might the *Percy Anecdotes* be traced. They were very successful, and a large sum was realized by the work.

Peele's Coffee-house, Nos. 177 and 178, Fleet-street, east corner of Fetter-lane, was one of the coffee-houses of the Johnsonian period; and here was long preserved a portrait of Dr. Johnson, on the keystone of a chimney-piece, stated to have been painted by Sir Joshua Reynolds. Peele's was noted for files of newspapers from these dates: *Gazette*, 1759; *Times*, 1780; *Morning Chronicle*, 1773; *Morning Post*, 1773; *Morning Herald*, 1784; *Morning Advertiser*, 1794; and the evening papers from their commencement. The house is now a tavern.

### *Coffee Literature and Ideals*

The bibliography at the end of this work will serve to indicate the nature and extent

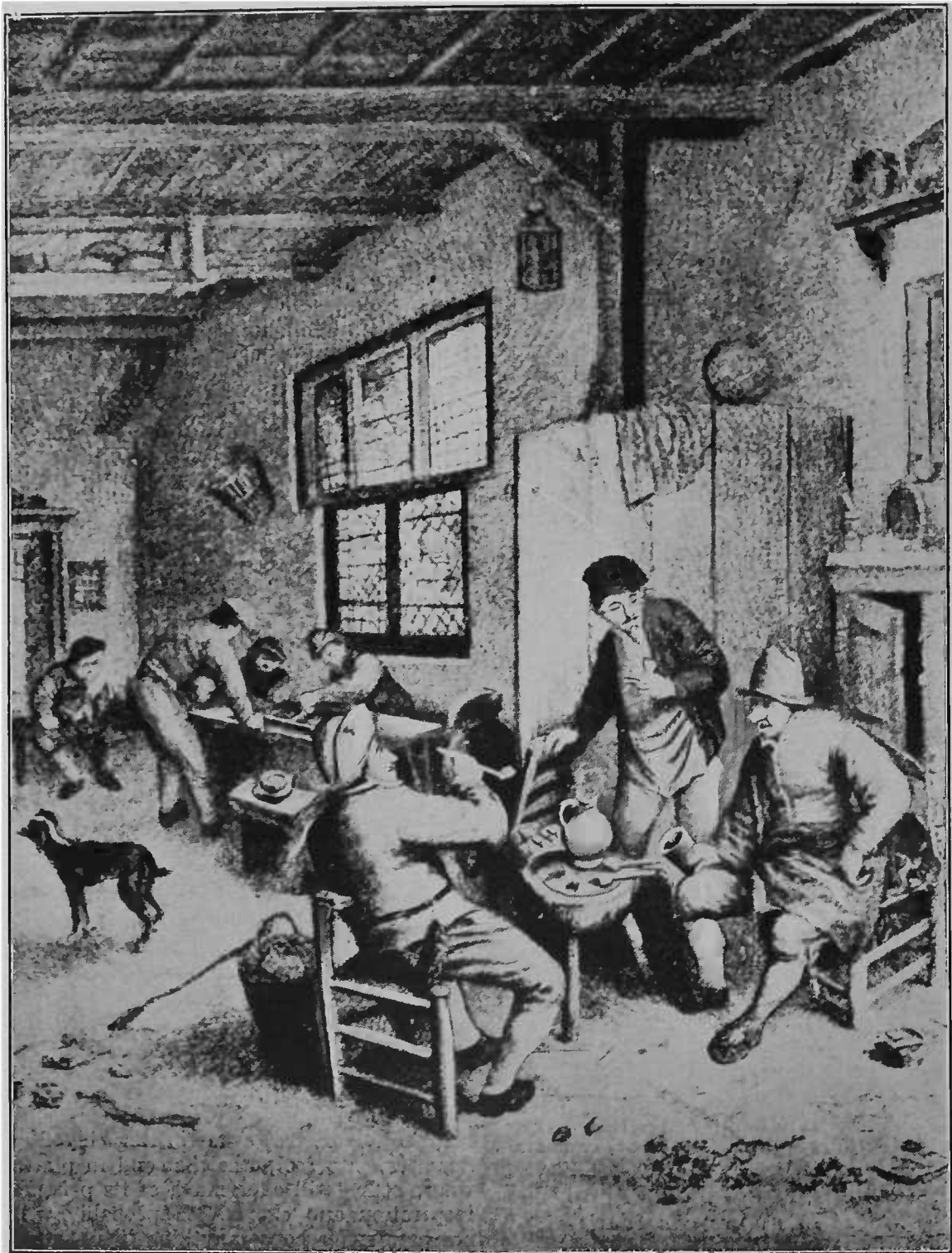
of the general literature of coffee. Not that it is complete or nearly so; it would require twice the space to include mention of all the fugitive bits of verse, essays, and miscellaneous writings in newspapers and periodicals dealing with the poetry and romance, history, chemistry, and physiological effects of coffee. Only the early works and the more notable contributions of the last three centuries are included in the bibliography; but there is sufficient to enable the student to analyze the lines of general progress.

A study of the literature of coffee shows that the French really internationalized the beverage. The English and Italians followed. With the advent of the newspaper press, coffee literature began to suffer from its competition.

The complexities of modern life suggest that coffee drinking in perfection, the esthetics, and a new literature of coffee may once more become the pleasure of a small caste. Are the real pleasures of life, the things truly worth while, only to the swift—the most efficient? Who shall say? Are not some of us, particularly in America, rather prone to glorify the gospel of work to such an extent that we are in danger of losing the ability to understand or to enjoy anything else?

Granted that this is so, coffee, already recognized as the most grateful lubricant known to the human machine, is destined to play another part of increasing importance in our national life as a kind of national shock-absorber as well. But its rôle is something more than this, surely. When life is drab, it takes away its grayness. When life is sad, it brings us solace. When life is dull, it brings us new inspiration. When we are a-weary it brings us comfort and good cheer.

The lure of coffee lies in its appeal to our finer sensibilities; and signs are not wanting that that pursuit of the long, sweet happiness that every one is seeking will lead some of us, even in big bustling America, into footpaths that end in places where coffee will offer much of its pristine inspiration and charm. It probably will not be a coffee house anything like that of the long ago, but perhaps it will be a kind of modernized coffee club. Why not?



**A COFFEE HOUSE IN HOLLAND, ABOUT 1650**

From an etching by J. Beauvarlet after the painting by Adriaen van Ostade (1610-1685), which is said to be the earliest picture of a coffee house in western Europe

## CHAPTER XXXVIII

### COFFEE IN RELATION TO THE FINE ARTS

HOW COFFEE AND COFFEE DRINKING HAVE BEEN CELEBRATED IN PAINTING, ENGRAVING, SCULPTURE, CARICATURE, LITHOGRAPHY, AND MUSIC—EPICS, RHAPSODIES, AND CANTATAS IN PRAISE OF COFFEE—BEAUTIFUL SPECIMENS OF THE ART OF THE POTTER AND THE SILVERSMITH AS SHOWN IN THE COFFEE SERVICE OF VARIOUS PERIODS OF THE WORLD'S HISTORY—SOME HISTORICAL RELICS

COFFEE has inspired the imagination of many poets, musicians, and painters. In the seventeenth and eighteenth centuries those whose genius was dedicated to the fine arts seem to have fallen under its spell and to have produced much of great beauty that has endured. To the painters, engravers, and caricaturists of that period we are particularly indebted for pictures that have added greatly to our knowledge of early coffee customs and manners.

Adriaen van Ostade (1610-1685), the Dutch genre painter and etcher, pupil of Frans Hals, in his "Dutch Coffee House" (1650), shows the genesis of the coffee house of western Europe about the time it still partook of some of the tavern characteristics. Coffee is being served to a group in the foreground. It is believed to be the oldest existing picture of a coffee house. The illustration is after the etching by J. Beauvarlet in the graphic collection at Munich.

William Hogarth (1697-1764), the famous English painter and engraver of satirical subjects, chose the coffee houses of his time for the scenes of a number of his social caricatures. In his series, "Four Times of the Day," which throws a vivid light on the street life of London of the period of 1738, we are shown Covent Garden at 7:55 A.M. by the clock on St. Paul's Church. A prim maiden lady, said to have been sketched from an elderly relation of the artist, who cut him out of her will, on her way home from early service, accompanied

by a shivering foot-boy, is scandalized by the spectacle presented by some roystering blades issuing from Tom King's notorious coffee house to the right. The *beaux* are forcing their attentions upon the more comely of the market women in the foreground. Tom King was a scholar at Eton before he began his ignoble career. At the date of this picture, it is thought he had been succeeded by his widow, Moll King, also of scandalous repute.

Scene VI of the "Rake's Progress," by Hogarth, is laid at the club in White's chocolate (coffee) house, which Dr. Swift described as "the common rendezvous of infamous sharpers and noble cullies." The rake has lost all his recently acquired wealth, pulls off his wig and flings himself upon the floor in a paroxysm of fury and execration. In allusion to the burning of White's in 1733, flames are seen bursting from the wainscot, but the pre-occupied gamblers take no heed, even of the watchman crying "Fire!" To the left is seated a highwayman, with horse pistol and black mask in a skirt pocket of his coat. He is so engrossed in his thoughts that he does not notice the boy at his side offering a glass of liquor on a tray. The scene well depicts the low estate to which White's had fallen. It recalls a bit of dialogue from Farquhar's *Beaux' Stratagem* (act III, scene 2), where Aimwell says to Gibbet, who is a highwayman: "Pray, sir, ha'nt I seen your face at Will's Coffee House?" "Yes sir, and at White's, too," answers the highwayman. After the fire, the club and chocolate





IN THE CLUB AT WHITE'S COFFEE HOUSE, 1733

From a painting in the series, "The Rake's Progress," by William Hogarth

house were removed to Gaunt's coffee house. The removal was thus announced in the *Daily Post* of May 3:

This is to acquaint all noblemen and gentlemen that Mr. Arthur having had the misfortune to be burnt out of White's Chocolate House is removed to Gaunt's Coffee House, next the St. James Coffee House in St. James Street, where he humbly begs they will favour him with their company as usual.

Alessandro Longhi (1733-1813), the Italian painter and engraver, called the Venetian Hogarth, in one of his pictures presenting life and manners in Venice during the years of her decadence, shows Goldoni, the dramatist, as a visitor in a café of the period, with a female mendicant soliciting alms.

In the Louvre at Paris hangs the "Petit Déjeuner" by François Boucher (1703-1770), famous court painter of Louis XV. It shows a French breakfast-room of the

period of 1744, and is interesting because it illustrates the introduction of coffee into the home; it shows also the coffee service of the time.

In Van Loo's portrait of Madame de Pompadour, second mistress and political adviser of Louis XV of France, the coffee service of a later period of the eighteenth century appears. The Nubian servant is shown offering the marquise a demi-tasse which has just been poured from the covered oriental pot which succeeded the original Arabian-Turkish boiler, and was much in vogue at the time.

Coffee and Madame du Barry (or would it be more polite to say Madame du Barry and coffee?) inspired the celebrated painting of Madame de Pompadour's successor in the affections of Louis, "the well beloved." This is entitled "Madam du Barry at Versailles," and in the Versailles catalog it is described as painted by De-



TOM KING'S COFFEE HOUSE IN COVENT GARDEN, 1738

From a painting in the series, "Four Times of the Day," by William Hogarth

crease after Drouais. Decreuse was a pupil of Gros, and painted many of the historical portraits at Versailles.

Malcolm C. Salaman, in his *French Color Prints of the XVIII Century*, referring to Dagoty's print of this picture, done

in 1771, says "the original has been attributed to Francois Hubert Drouais, but there can be little doubt that the original portraiture was from the hand of the engraver (Dagoty), as the style is far inferior to Drouais." He thus describes it:



"PETIT DEJEUNER," BY BOUCHER

Showing the home coffee service of the period of 1744

Here we see the last of Louis XV's mistresses sitting in her bedroom in that alluring retreat of hers at Louveciennes, near the woods of Marly, as she takes her cup of coffee from her pet attendant, the little negro boy, Zamore, as the Prince de Conti had named him, all brave in red and gold. Doubtless she is expecting the morning visit of the King, no longer the handsome young gallant, but old and leaden-eyed, and puffy-cheeked; and perhaps it will be on this very morning that she will wheedle Louis, in a moment of extravagant badinage, into appointing the negro boy to be Governor of the Chateau and Pavilion of Louveciennes at a handsome salary, just as, on another day, she playfully teased the jaded old sensualist into decorating with the cordon bleu her cuisinière when it was triumphantly revealed to him that the dinner he had been praising with enthusiastic gusto was, after all, the work of a woman cook, the very possibility of which he had contemptuously doubted. But as we look at these two, the royal mistress and her little black favorite, we forget the "well beloved" and his voluptuous pleasures and indulgences, for in the shadows we see another picture, some twenty years on, when the proud unconscionable beauty, no longer *reine de la main gauche*, stands before the dreaded Tribunal of the Terror, while Zamore, the treacherous, ungrateful negro, dismissed from his service at Louveciennes and now devoted to the committee of public safety, and one of her implacable accusers, sends her shrieking to the guillotine.

The introduction of the coffee house into Europe was memorialized by Franz Schams, the genre painter, pupil of the Vienna Academy, in a beautiful picture entitled "The First Coffee House in Vienna, 1684," owned by the Austrian Art Society. A lithographic reproduction was executed by the artist and printed by Joseph Stoufs in Vienna. There are several specimens in the United States; and the illustration printed on page 44 has been made from one of these in the possession of the author.

The picture shows the interior of the Blue Bottle, where Kolschitzky opened the first coffee house in Vienna. The hero-proprietor stands in the foreground pouring a cup of the beverage from an oriental coffee pot, and another is suspended from the coffee-house sign that hangs over the fireplace. In the fire alcove a woman is pounding coffee in a mortar. Men and women in the costumes of the period are being served coffee by a Vienna *mädchen*.

The painters Marilhat, Descamps, and de Tournemine have pictured café scenes; the first in his "Café sur une route de Syrie," which was shown at the Salon of 1844; the second in his "Café Turc," which figured at the Exposition of 1855; and the third in his "Café en Asia Mineure," which re-



COFFEE SERVICE IN THE HOME OF MADAME DE POMPADOUR—PAINTING BY VAN LOO



MADAME DU BARRY AND HER SLAVE BOY ZAMORE—PAINTING BY DECREUSE

ceived honors at the Salon in 1859, and attracted attention at the Universal Exposition of 1867.

A decorative panel designed for the buffet at the Paris Opera House by S. Mazerolles was shown at the Exposition of 1878. A French artist, Jacquand, has painted two charming compositions; one representing the reading room, and the other the interior, of a café.

Many German artists have shown coffee manners and customs in pictures that are now hanging in well known European galleries. Among others, mention should be made of C. Schmidt's "The Sweets Shop of Josty in Berlin," 1845; Milde's "Pastor Rautenberg and His Family at the Coffee Table," 1833; and his "Manager Classen and His Family at the Afternoon Coffee Table," 1840; Adolph Menzel's "Parisian Boulevard Café," 1870; Hugo Meith's "Saturday Afternoon at the Coffee Table"; John Philipp's "Old Woman with Coffee Cup"; Freidrich Walle's "Afternoon Coffee in the Court Gardens at Munich"; Paul Meyerheim's "Oriental Coffee

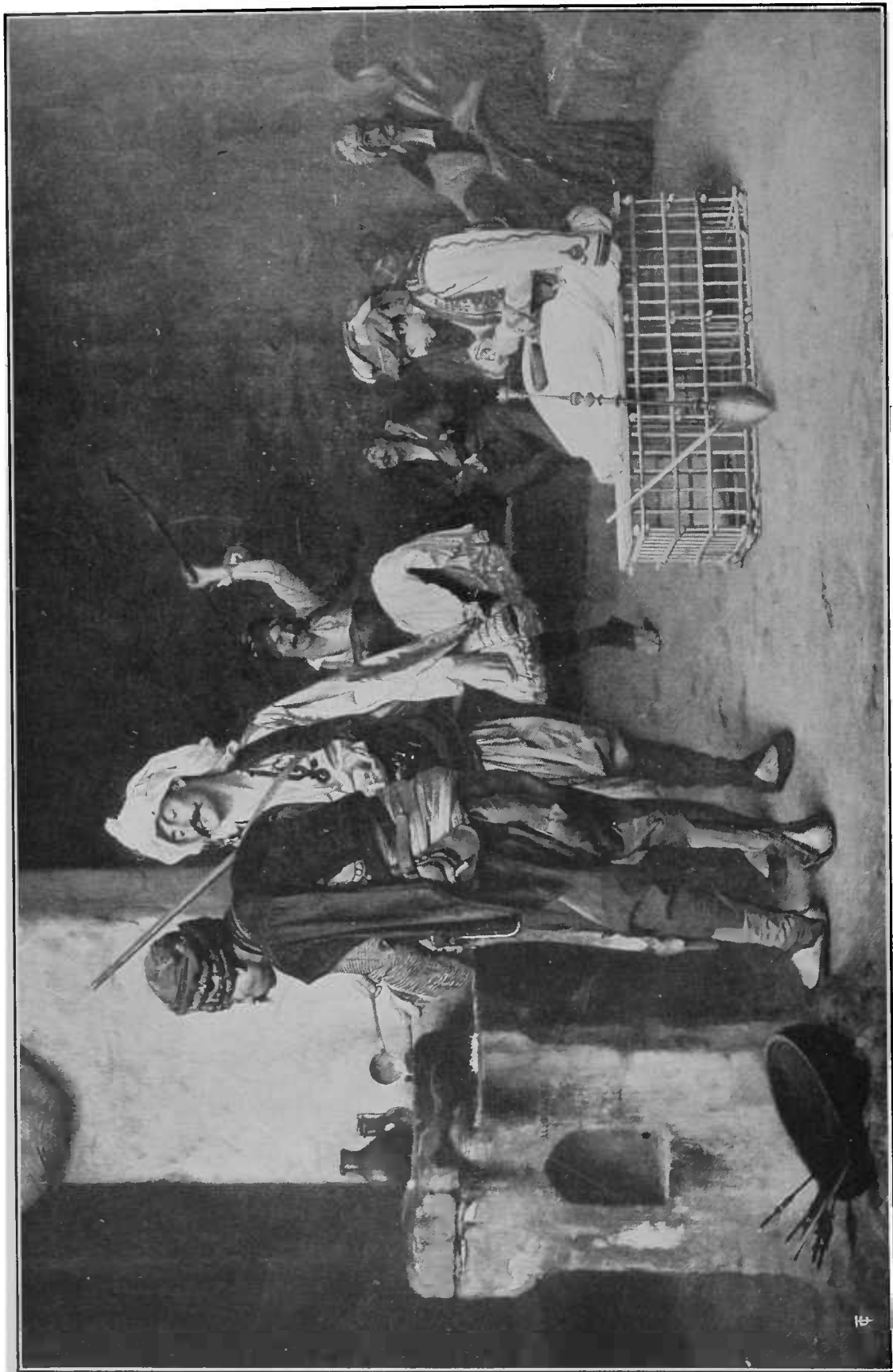
House"; and Peter Philippi's (Dusseldorf) "Kaffeebesuch."

At the Exposition des Beaux Arts, Salon of 1881, there was shown P. A. Ruffio's picture, "Le café vient au secours de la Muse" (Coffee comes to the aid of the Muse), in which the graceful form of an oriental ewer appears.

The "Coffee House at Cairo," a canvas by Jean Léon Gérôme (1824-1904) that hangs in the Metropolitan Museum of Art, New York, has been much admired. It shows the interior of a typical oriental coffee house with two men near a furnace at the left preparing the beverage; a man seated on a wicker basket about to smoke a hooka; a dervish dancing; and several persons seated against the wall in the background.

The New York Historical Society acquired in 1907 from Miss Margaret A. Ingram an oil painting of the "Tontine Coffee House." It was painted in Philadelphia by Francis Guy, and was sold at a raffle, after having been admired by President John Adams. It shows lower Wall





COFFEE HOUSE AT CAIRO—PAINTING BY GÉRÔME IN THE METROPOLITAN MUSEUM, NEW YORK



Street in 1796-1800, with the Tontine coffee house on the northwest corner of Wall and Water Streets, where its more famous predecessor, the Merchants coffee house, was located before it moved to quarters diagonally opposite.

Charles P. Gruppe's (b. 1860) painting showing General "Washington's Official Welcome to New York by City and State Officials at the Merchants' Coffee House," April 23, 1789, just one week before his inauguration as first president of the United States, is a colorful canvas that has been much praised for its atmosphere and historical associations. It is the property of the author.

The art museums and libraries of every country contain many beautiful water-colors, engravings, prints, drawings, and lithographs, whose creators found inspiration in coffee. Space permits the mention of only a few.

T. H. Shepherd has preserved for us Button's, afterward the Caledonien coffee house, Great Russell Street, Covent Garden, in a water-color drawing of 1857; Tom's coffee house, 17 Great Russell Street, Covent Garden, 1857; Slaughter's coffee house in St. Martin's Lane, 1841; also, in 1857, the Lion's Head at Button's, put up by Addison and now the property of the Duke of Bedford at Woburn.

Hogarth is represented in the Sam Ireland collection by several original drawings of frequenters of Button's in 1730.

Thomas Rowlandson (1756-1827), the great English caricaturist and illustrator, has given us several fine pictures of Eng-



"KAFFEEBESUCH"

From the painting by Peter Philippi



"COFFEE COMES TO THE AID OF THE MUSE"  
From the painting by Ruffio

lish coffee-house life. His "Mad Dog in a Coffee House" presents a lively scene; and his water-color of "The French Coffee House" is one of the best pictures we have of the French coffee house in London as it looked during the latter half of the eighteenth century.

During the campaign in France in 1814, Napoleon arrived one day, unheralded, in a country presbytery, where the good curé was quietly turning his hand coffee-roaster. The emperor asked him, "What are you doing there, abbé?" "Sire," replied the priest, "I am doing like you. I am burning the colonial fodder." Charlet (1792-1845) made a lithograph of the incident.

Several French poet-musicians resorted to music to celebrate coffee. Brittany has its own songs in praise of coffee, as have other French provinces. There are many epics, rhapsodies, and cantatas—and even a comic opera by Meilhat, music by Deffes, bearing the title, *Le Café du Roi*, produced at the Théâtre Lyrique, November 16, 1861.

Fuzelier wrote, in honor of coffee, a cantata, set to music by Bernier. This is the burden of the poet's song:

Ah coffee, what climes yet unknown,  
 Ignore the clear fires that thy vapors inspire!  
 Thou countest, in thy vast empire  
 Those realms that Bacchus' reign disown.  
 Favored liquid, which fills all my soul with  
 delights,  
 Thy enchantments to life happy hours persuade,  
 We vanquish e'en sleep by thy fortunate aid,  
 Thou hast rescued the hours sleep would rob  
 from our nights.  
 Favored liquid which fills all my soul with  
 delights,  
 Thy enchantments to life happy hours persuade.

Oh liquid that I love,  
 Triumphant stream of sable,  
 E'en for the gods above,  
 Drive nectar from the table.  
 Make thou relentless war  
 On treacherous juices sly,  
 Let earth taste and adore  
 The sweet calm of the sky.  
 Oh liquid that I love,  
 Triumphant stream of sable,  
 E'en for the gods above,  
 Drive nectar from the table.

During the early vogue of the café in Paris, a *chanson*, entitled *Coffee*, reproduced on page 715, was set to music with accompaniment for the piano by M. H. Colet, a professor of harmony at the Conservatoire. Printed in the form of a placard, and put up in cafés, it received the approbation of, and was signed by de Voyer

d'Argenson, lieutenant of police. The poetry is not irreproachable. It can hardly be attributed to any of the well known poets of the time; but rather to one of those bohemian rimesters that wrote all too abundantly on all sorts of subjects. It is the development of a theory concerning the properties of coffee and the best method of making it. It is interesting to note that the uses of advertising were known and appreciated in Paris in 1711; for in the *chanson* there appears the name and address of one Vilain, a merchant, rue des Lombards, who was evidently in fashion at that period. The translation of the stanza reproduced is as follows:

#### COFFEE—A CHANSON

If you, with mind untroubled,  
 Would flourish, day by day,  
 Let each day of the seven  
 Find coffee on your tray.  
 It will your frame preserve from every malady,  
 Its virtues drive afar, la! la!  
 Migrain and dread catarrh—ha! ha!  
 Dull cold and lethargy.

The most notable contribution to the "music of coffee," if one may be permitted the expression, is the *Coffee Cantata* of Johann Sebastian Bach (1685-1750), the German organist and the most modern com-



"MAD DOG IN A COFFEE HOUSE"—CARICATURE BY ROWLANDSON



NAPOLEON AND THE CURBÉ—LITHOGRAPH BY CHARLET

poser of the first half of the eighteenth century. He hymned the religious sentiment of protestant Germany; and in his *Coffee Cantata* he tells in music the protest of the fair sex against the libels of the enemies of the beverage, who at the time were actively urging in Germany that it should be forbidden women, because its use made for sterility! Later on, the government surrounded the manufacture, sale, and use of coffee with many obnoxious restrictions, as told in chapter VII.

Bach's *Coffee Cantata* is No. 211 of the *Secular Cantatas*, and was published in Leipzig in 1732. In German it is known as *Schweigst stille, plaudert nicht* (Be silent, do not talk). It is written for soprano, tenor, and bass solos and orchestra. Bach used as his text a poem by Piccander. The cantata is really a sort of one-act operetta; a jocose production representing the efforts of a stern parent to check his daughter's propensities for coffee drinking, the

new-fashioned habit. One seldom thinks of Bach as a humorist; but the music here is written in a mock-heroic vein, the recitatives and arias having a merry flavor, hinting at what the master might have done in light opera.

The libretto shows the father Schlendrian, or Slowpoke, trying by various threats to dissuade his daughter from further indulgence in the new vice, and, in the end, succeeding by threatening to deprive her of a husband. But his victory is only temporary. When the mother and the grandmother indulge in coffee, asks the final trio, who can blame the daughter?

Bach uses the spelling coffee—not *kaffee*. The cantata was sung as recently as December 18, 1921, at a concert in New York by the Society of the Friends of Music, directed by Arthur Bodanzky.

Lieschen, or Betty, the daughter, has a delightful aria, beginning, "Ah, how sweet coffee tastes—lovelier than a thousand kis-

ARIE.

Flauto traverso.

Lieschen.

Continuo.

Eil wie schmeckt der Coffee süsse, lieber als tausend Küsse, mil der als

Muscaten-Wein. Ei, ei, wie schmeckt der Coffee, ei,

“AH, HOW SWEET COFFEE TASTES—LOVELIER THAN A THOUSAND KISSES, SWEETER FAR THAN MUSCATEL WINE!”

Opening bars of Betty's aria in Bach's *Coffee Cantata*, 1732

ses, sweeter far than muscatel wine!" the opening bars of which are reproduced on page 714.

As the text is not long, it is printed here complete.

CHARACTERS

MESSENGER AND NARRATOR ..... Tenor  
SLOWPOKE ..... Bass  
BETTY, DAUGHTER TO SLOWPOKE ..... Soprano

TENOR (*Recitative*). Be silent, do not talk, but notice what will happen! Here comes old Slowpoke with his daughter Betty. He's grumbling like a common bear—just listen to what he says.

(*Enter SLOWPOKE muttering*). What vexatious things one's children are! A hundred thousand naughty ways! What I tell my daughter Betty might as well be told to the moon!  
(*Enter BETTY*.)

SLOWPOKE (*Recitative*). You naughty child, you mischievous girl, oh when can I have my way—give up your coffee!

BETTY. Dear father, do not be so strict! If I can't have my little demitasse of coffee three times a day, I'm just like a dried up piece of roast goat!

BETTY (*Aria*). Ah! How sweet coffee tastes! Lovelier than a thousand kisses, sweeter far than muscatel wine! I must have my coffee, and



STATUE OF KOLSCHITZKY IN VIENNA

LE CAFÉ, avec accompagnement de piano par H. COLET, professeur d'harmonie au Conservatoire.

*Allegro. 3/4*

CHANT.

PIANO.

Si vous vou-lex sans pei - ne vivre en bon-ne san - té, Sept jours de la se - mai - ne Pre - nez du bonca - fé, il vous pré-ser-ve - ra De tou-te ma-la - di - e, Sa ver-tu chasse - ra, Là, là, Mi - graine et flu - xi - on, Don, don, Rhume et mélan-co - li - e.

*Fin.*

COFFEE—A CHANSON; MUSIC BY COLET, 1711

if any one wishes to please me, let him present me with—coffee!

SLOWPOKE (*Recitative*). If you won't give up coffee, young lady, I won't let you go to any wedding feasts—I won't even let you go walking!

BETTY. O yes! Do let me have my coffee!

SLOWPOKE. What a little monkey you are, anyway! I will not let you have any whalebone skirts of the present fashionable size!

BETTY. Oh, I can easily fix that!

SLOWPOKE. But I won't let you stand at the window and watch the new styles!

BETTY. That doesn't bother me, either. But be good and let me have my coffee!

SLOWPOKE. But from my hands you'll get no silver or gold ribbon for your hair!

BETTY. Oh well! so long as I have what does satisfy me!

SLOWPOKE. You wretched Betty, you! You won't give in to me?

SLOWPOKE (*Air*). Oh these girls—what obstinate dispositions they do have! They certainly are not easy to manage! But if one hits the right spot—oh well, one may succeed!

SLOWPOKE, *with an air of being sure of success this time* (*Recitative*). Now please do what father says.

BETTY. In everything, except about coffee.





THE MOST BEAUTIFUL COFFEE HOUSE IN THE WORLD

The Caffè Pedrocchi in Padua, Italy, Empire period, erected by the poor lemonade vender and coffee seller, Antonio Pedrocchi.

SLOWPOKE. Well, then, you must make up your mind to do without a husband.

BETTY. Oh—yes? Father, a husband?

SLOWPOKE. I swear you can't have him—

BETTY. Till I give up coffee? Oh well—coffee—let it be forgotten—dear father—I will not drink—none!

SLOWPOKE. *Then you can have one!*

BETTY (*Aria*). To-day, dear father—do it to-day. (*He goes out.*) Ah, a husband! Really this suits me exactly! When they know I must have coffee, why, before I go to bed to-night I can have a valiant lover! (*Goes out.*)

TENOR (*Recitative*). Now go hunt up old Slowpoke, and just watch him get a husband for his daughter—for Betty is secretly making it known “that no wooer may come to the house, unless he promises me himself, and has it put in the marriage contract that he will allow me to make coffee whenever I will!”

(*Enter SLOWPOKE and BETTY, singing—as chorus—with TENOR.*)

TRIO. The cat will not give up the mouse, old maids continue “coffee-sisters!”—the mother loves her drink of coffee—grandma, too, is a coffee fiend—who now will blame the daughter!



COFFEE GRINDER SET WITH JEWELS  
In the Metropolitan Museum of Art, New York



COVER TITLES OF POPULAR COFFEE SONGS

In 1925, at Leeds, England, the British National Opera Company performed a one-act operatic version of Bach's *Coffee Cantata* entitled "Coffee and Cupid." The translation and adaptation was by Prof. Sanford-Terry. The music, which was arranged by Mr. Percy Pitt, incorporated the familiar *Coffee Cantata* with additions drawn from others of Bach's secular works.

In the original, Betty (Lieschen) gives up her coffee for marital bliss. But Mr. Sanford-Terry, in interpreting an additional movement by the composer, carries it a stage further. The lady, apparently falling in with her father's wishes, signs a marriage contract. Slowpoke (Schlenderian) is fatuously complacent at what he imagines is his victory, but once Betty has made sure of Cupid she proceeds to show her father and the wedding guests that she intends also to have her coffee as usual. Coffee is handed round to the assembled guests, to the complete discomfiture of Slowpoke. In his rage, he dashes his wig into the tray of coffee cups and hurls it to the ground, and in the last picture one has of this tyrannical parent he is floundering, bald and impotent, in the brew he detests.

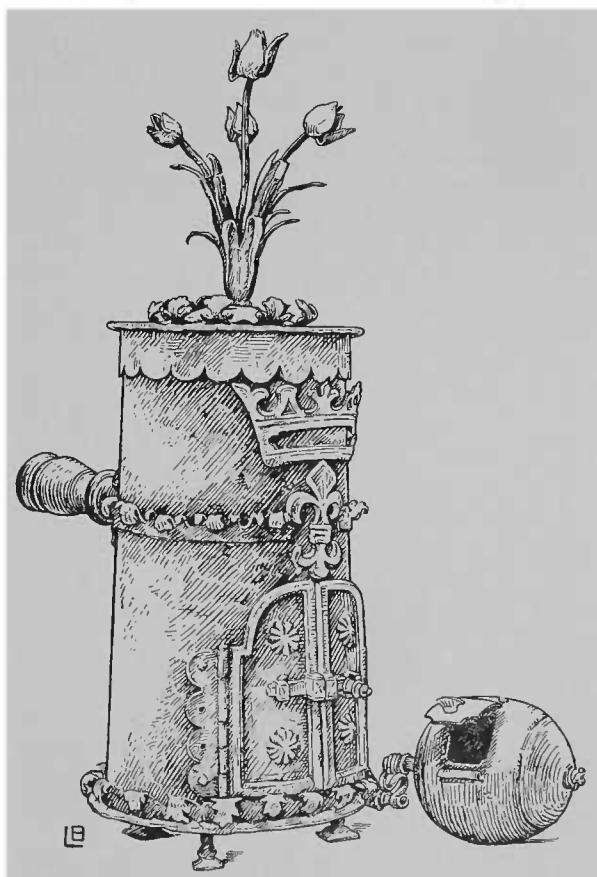
Guatemala has given us a waltz called "La Flor del Café" (The Coffee Flower), attributed to Alcántara.

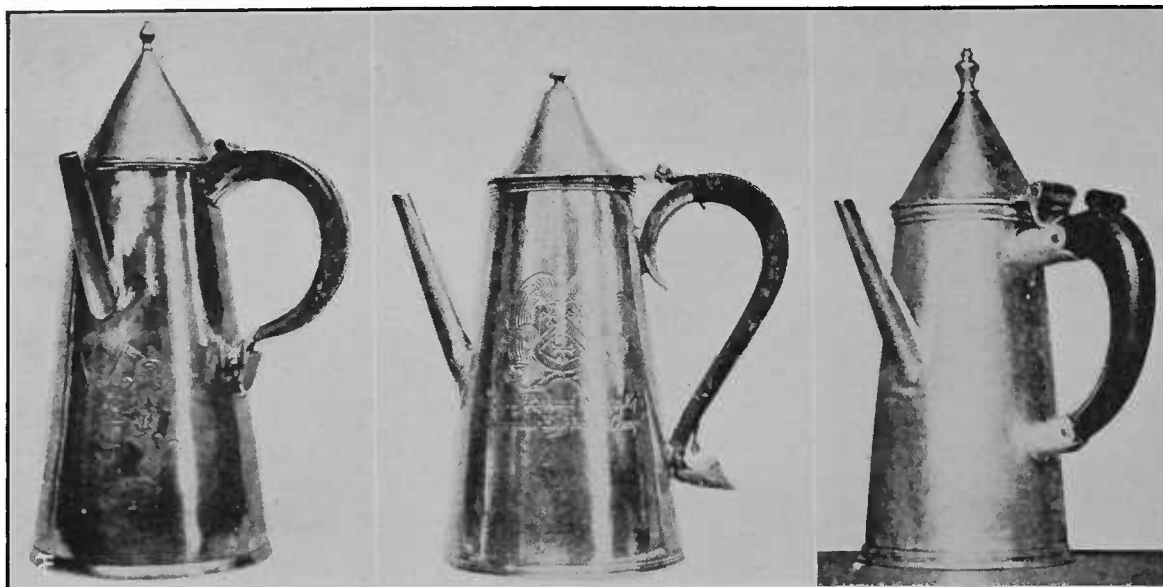
Coffee has proven quite a source of inspiration for Tin Pan Alley, America's

fountain-head for popular songs. First there was "A Cup of Coffee, a Sandwich and You," introduced into several *revues*. "Your the Cream in My Coffee" was featured in *Hold Everything*; Irving Berlin's "Let's Have Another Cup of Coffee" swept the country; "Coffee in the Morning and Kisses in the Night" was a motion picture song success; and "All over a Cup of Coffee" was a story in song of how life's little tragedies and comedies are sometimes linked up with our national beverage.

Research has discovered only one piece of sculpture associated with coffee—the statute of the Austrian hero Kolschitzky, the patron saint of the Vienna coffee houses. It graces the second-floor corner of a house in the Favoriten Strasse, where it was erected in his honor by the Coffee Makers' Guild of Vienna. The great "brother-heart" is shown in the attitude of pouring coffee into cups on a tray from an oriental service pot.

The celebrated Caffè Pedrocchi, the center of life in the city of Padua, Italy, in the early part of the nineteenth century,

ITALIAN WROUGHT-IRON COFFEE ROASTER  
In the *Edison Monthly*



Teapot, 1670

Coffee Pot, 1681

Coffee Pot, 1689

## SEVENTEENTH-CENTURY TEA AND COFFEE POTS

is one of the most beautiful buildings erected in Italy. Its use is apparent at first glance. It was begun in 1816, opened June 9, 1831, and completed in 1842. Antonio Pedrocchi (1776-1852), an obscure Paduan coffee-house keeper, tormented by a desire for glory, conceived the idea of building the most beautiful coffee house in the world, and carried it out.

Artists and craftsmen of all ages since the discovery of coffee have brought their genius into play to fashion various forms of apparatus associated with the preparation of the coffee drink. Coffee roasters and grinders have been made of brass, silver, and gold; coffee mortars, of bronze; and coffee making and serving pots, of beautiful copper, pewter, pottery, porcelain, and silver designs.

In the Peter collection in the United States National Museum there is to be seen a fine specimen of the Bagdad coffee pot made of beaten copper and used for making and serving; also, a beautiful Turkish coffee set. In the Metropolitan Museum in New York there are some beautiful specimens of Persian and Egyptian ewers in faience, probably used for coffee service. Also, in American and continental museums are to be seen many examples of seventeenth-century German, Dutch, and English bronze mortars and pestles used for "braying" coffee beans.

A very beautiful specimen of the oriental coffee grinder, made of brass and teakwood, set with red and green glass jewels,

and inlaid in the teakwood with ivory and brass, is at the Metropolitan. This is of Indo-Persian design of the nineteenth century.

The Metropolitan Museum shows also many specimens of pewter coffee pots used in India, Germany, Holland, Belgium, France, Russia, and England in the seventeenth and eighteenth centuries.

One can guess at the luxuriousness of the coffee pots in use in France throughout the eighteenth century by noting that from March 20, 1754, to April 16, 1755, Louis XV bought no fewer than three gold coffee pots of Lazare Duvaux. They had carved branches, and were supplied with "chafing dishes of burnished steel" and lamps for spirits of wine. They cost, respectively, 1,950, 1,536, and 2,400 francs. In the "inventory of Marie-Josephe de Saxe, Dauphine of France," we note, too, a "two cup coffee pot of gold with its chafing dish for spirits of wine in a leather case."

The Italian wrought-iron coffee roaster of the seventeenth century was often a work of art. The specimen illustrated is rich in decorative motifs associated with the best in Florentine art.

Madame de Pompadour's inventory disclosed a "gold coffee mill, carved in colored gold to represent the branches of a coffee tree." The art of the goldsmith, which sought to embellish everything, did not disdain these homely utensils; and one may see at the Cluny Museum in Paris, among

many mills of graceful form, a coffee mill of engraved iron dating from the eighteenth century, upon which are represented the four seasons. We are told, however, that it graced the "sale after the death of Mme. de Pompadour," which, of course, makes it much more valuable.

"The tea pot, coffee pot, and chocolate pot first used in England closely resembled each other in form," says Charles James Jackson in his *Illustrated History of English Plate*, "each being circular in plan, tapering towards the top, and having its handle fixed at a right angle with the spout."

He says further:

The earliest examples were of oriental ware and the form of these was adopted by the English plate workers as a model for others of silver. It apparently was not until after both tea and coffee had been used for several years in this country [England] that the tea pot was made proportionately less in height and greater in diameter than the coffee pot. This distinction, which was probably due to copying the forms of Chinese porcelain tea pots, was afterwards maintained, and to the present day the difference between the teapot and the coffee pot continued to be mainly one of height.



FOLKINGHAM POT, 1715-16



LANTERN COFFEE POT, 1692

The coffee pot illustrated (1681) formerly belonged to the East India Company, and is preserved in the Victoria and Albert Museum. It is almost identical with a teapot (1670) in the same museum, except that its straight spout is fixed nearer to the base, as is its leather-covered handle, which, with the sockets into which it fits, forms a long recurving scroll fixed opposite to and in line with the spout. Its cover, which is hinged to the upper handle socket, is high like that of the 1670 teapot; but instead of the straight outline of that cover, this is slightly waved and surmounted by a somewhat flat button-shaped knob. Engraved on the body is a shield of arms, a chevron between three crosses fleury, surrounded by tied feathers. The inscription is "The Guift of Richard Sterne Eq to ye Honorable East India Compa."

This pot is nine and three-quarters inches in height by four and seven-eighths inches in diameter at the base; it bears the London hall-marks of 1681-82 and the maker's mark "G. G." in a shield-shaped shield, thought by Jackson to be George Garthorne's mark.

The 1689 coffee pot illustrated is the property of King George V. It bears the London hall-marks of 1689-90, and the mark of Francis Garthorne. Its tall, round



IRISH COFFEE POT, 1760  
Hall-marked Dublin; the property of Col. Moore-Brabazon



VISCOUNTESS WOLSELEY'S COFFEE POT



A SCOFIELD POT OF 1779-80



COFFEE JUG, 1736

SILVER COFFEE POTS OF THE EIGHTEENTH CENTURY



body tapers toward the top, and has applied moldings on the base and rim. Its spout is straight and tapers upward to the level of the rim of the pot. Its handle is of ebony, crescent-shaped, and riveted into two sockets fixed at a right angle with the spout. The lid is a high cone surmounted by a small vase-shaped finial, and is hinged to the upper socket of the handle. On no part of the pot is there any ornamentation other than the royal cipher of King William III and Queen Mary, which is engraved on the reverse side of the body. This example, which measures nine inches in height to the top of its cover, resembles very closely in form the East India Company's tea-pot just referred to; but as tea-pots with much lower bodies appear to have come into fashion before 1689, this pot was probably used as a coffee pot from the first.

The 1692 coffee pot of lantern shape is the property of H. D. Ellis, and has its spout curved upward at the top, being furnished with a small, hinged flap and a scroll-shaped thumb-piece attached to the rim of the cover. The body and cover were originally quite plain, the embossing and chasing with symmetrical rococo decoration being added later, probably about 1740.



"DISH OF COFFEE BOY" DESIGN IN DELFT TILES  
1692



WASTELL POT, 1720-21

Jackson says the wooden handle is not the original one, which was probably C-shaped. The pot bears the usual London hall-marks for the year 1692 and the maker's mark is "G G" upon a shield, a mark recorded upon the copper plate belonging to the Goldsmiths' company, which Mr. Cripps thinks was that of George Garthorne. The characteristics of this lantern-shaped coffee pot are:

1. The straight sides, so rapidly tapering from the base upward that in a height of only six inches the base diameter of four and three-eighths inches tapers to a diameter of no more than two and one-half inches at the rim.
2. The nearly straight spout, furnished with a flap or shutter.
3. The true cone of the lid.
4. The thumb-piece, which is a familiar feature upon the tankards of the period.
5. The handle fixed at right angles to the spout.

Mr. Ellis, in a paper before the Society of Antiquaries on the earliest form of coffee pot, says:

If coffee was first introduced into this country by the Turkey merchants, nothing is more probable than that those who first brought the berry, brought also the vessel in which it was to be served. Such a vessel would be the Turkish ewer whose shape is familiar to us, the same today as two hundred years ago, for in the East things are slow to change. And



ELERS WARE COFFEE POT  
Stoneware, about 1700

SALT-GLAZE POT  
By John Astbury

SALT-GLAZE POT  
About 1725



POTS IN POTTERY AND PORCELAIN 18TH TO 20TH CENTURIES

1—Staffordshire; 2—English, eighteenth to twentieth centuries; 3—English, eighteenth to nineteenth centuries; 4—Leeds, 1760-1790; 5—Staffordshire, nineteenth to twentieth centuries



CHINESE PORCELAIN COFFEE POT  
Late seventeenth century

throughout the reign of the second Charles, so long as the extended use of coffee in the houses of the people was retarded by the opposition of the Women of England, and by the scarcely less powerful influence of the King's Court, the small requirements of a mere handful of coffee-houses would be easily met by the importation of Turkish vessels. Reference to the coffee-house keepers' tokens in the Beaufoy collection in the Guildhall Museum shows that many of the traders of 1660-1675 adopted as their trade sign a hand pouring coffee from a pot. This pot is invariably of the Turkish ewer pattern. It is true that there is nothing to show that the Turks themselves ever served coffee from the ewer, but it is scarcely conceivable that the English coffee-house keepers should have adopted as their trade sign, their pictorial advertisement, so to speak, a vessel which had no connection with the commodity in which they dealt, and which would convey no meaning associated with coffee to the public. But as soon as the extended use of the beverage created a demand which stimulated a home manufacture of coffee-pots, a new departure is apparent. The undulating outlines beloved by the Orientals, bowed as their scimitars, curvilinear as their graceful flowing script, do not commend themselves to the more severe Western taste of the period which had then declared its preference for sweet simplicity in silver-smiths' work, such as we see in the basons, cups, and especially the flat-topped tankards



Vincent Pot, Hall-marked, London, 1738

Lord Swaythling's Pot, 1731

SILVER COFFEE POTS, EARLY EIGHTEENTH CENTURY  
From Jackson's "Illustrated History of English Plate"



SINO-LOWESTOFT, EIGHTEENTH TO NINETEENTH CENTURIES



ITALIAN CAPODIMONTE, EIGHTEENTH CENTURY



LA SEINE, 1774

SEVRES, 1792

GERMAN POTS, EIGHTEENTH CENTURY

PORCELAIN POTS IN THE METROPOLITAN MUSEUM, NEW YORK



SILVER COFFEE POTS, LATE EIGHTEENTH CENTURY  
Left, 1776-77. Right, 1773-74.

of that day. The beauty of the straight line had asserted its power, and fashion felt its sway. Such was the feeling that produced the coffee-pot of 1692, the straight lines of which continued in vogue until the middle of the following century, when a re-action in favour of bulbous bodies and serpentine spouts set in.<sup>1</sup>

Some of the more notable of the coffee-house-keepers' tokens in the Guildhall Museum were photographed for this work. They are described and illustrated in chapter IX.

There are illustrated other silver coffee pots in the Victoria and Albert Museum, by Folkingham (1715-16), and by Wastell (1720-21), the latter pot being octagonal.

There is illustrated also a design in tiles that were let into the wall of an ancient coffee house in Brick Lane, Spitalfields, known as the "Dish of Coffee Boy" in the catalog of the collection of London antiquities in the Guildhall Museum. Mr. Ellis thinks this belongs to a period a little earlier, but certainly not later, than 1692;

<sup>1</sup> *Proceedings: Second Series*, 1899 (vol. xvii: no 2; p. 390).

the coffee pot represented being exactly of the lantern shape. It is an oblong sign of glazed Delft tiles, decorated in blue, brown, and yellow, representing a youth pouring coffee. Upon a table, by his side, are a gazette, two pipes, a bowl, a bottle, and a mug; above, on a scroll, is, "dish of coffee boy."

Modifications of the lantern began to appear with great rapidity in England. In the coffee pot of Chinese porcelain, illustrated, probably made in China from an English model a few years later than the 1692 pot, Mr. Ellis observes that "the spout has already lost its straightness, the extreme taper of the body is diminished, and the lid betrays the first tendency to depart from the straightness of the cone to the curved outline of the dome." He adds:

These variations rapidly intensified, and at the commencement of the eighteenth century we find the body still less tapering and the lid has become a perfect dome. As we approach the end of Queen Anne's reign the thumb piece disappears and the handle is no longer set on at right angles to the spout. Through the reign of George I but little modification took place,

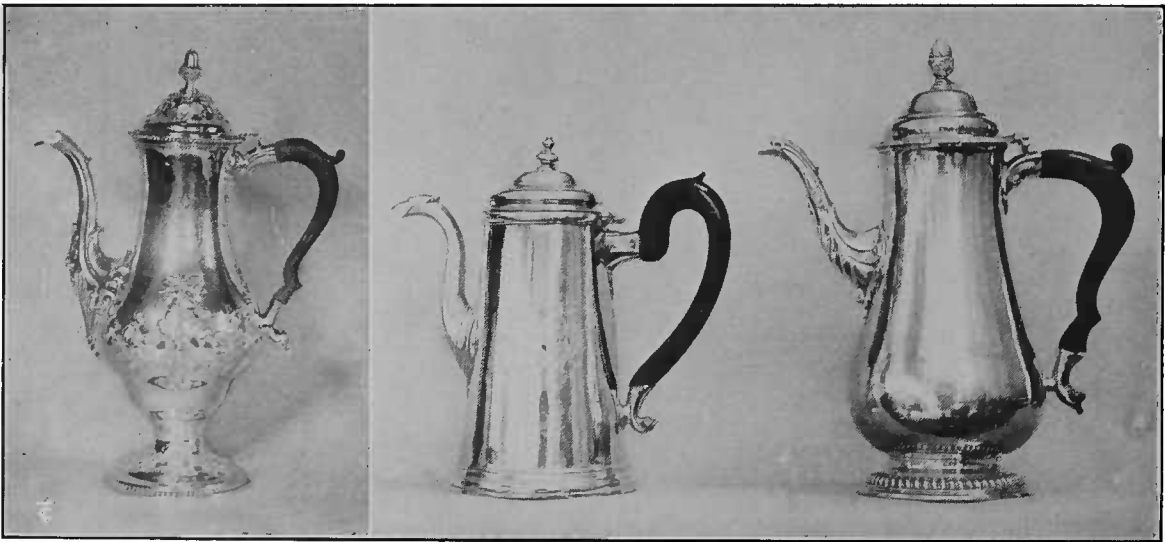




By Samuel Minott  
Halsey Collection

By Charles Hatfield  
Metropolitan Museum of Art

By Pygan Adams  
Clearwater Collection

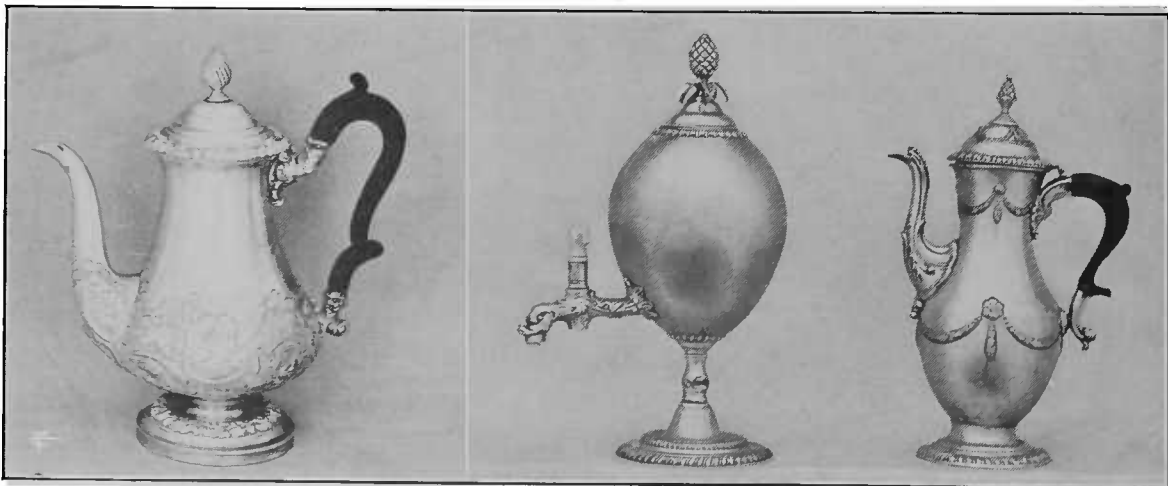


London Pot, 1773-74

By Jacob Hurd

By Paul Revere

FROM FRANCIS HILL BIGELOW'S "HISTORIC SILVER OF THE COLONIES"



ENGLISH SHEFFIELD PLATE COFFEE POTS AND COFFEE URN, EIGHTEENTH CENTURY  
SILVER COFFEE POTS IN AMERICAN COLLECTIONS

save that the taper of the body became less and less. In the Second George's time we find the taper has almost entirely disappeared, so that the sides are nearly parallel, while the dome of the lid has been flattened down to a very low elevation above the rim. In the second quarter of the eighteenth century the pear shaped coffee pot was the vogue. In the earlier years of George III, when many new and beautiful designs in silversmiths' work were created, a complete revolution in coffee-pots takes place, and the flowing outlines of the new pattern recall the form of the Turkish ewer, which had been discarded nearly one hundred years previously.

The evolution is shown by illustrations of Lord Swaythling's pot of 1731; the coffee jug of 1736; the Vincent pot of 1738; the Viscountess Wolseley's coffee pot of copper plated with silver; the Irish coffee pot of 1760; and the silver coffee pots of 1773-76 and of 1779-80 (see illustrations on pages 720, 723, and 725).

There are illustrated in this connection specimens of coffee pots in stoneware by Elers (1700), and in salt glaze by Astbury, and another of the period about 1725. These are in the department of British and medieval antiquities in the British Museum, where are to be seen also some beautiful



SPANISH COFFEE POT, EIGHTEENTH CENTURY  
In the Metropolitan Museum

specimens of coffee-service pots in Whieldon ware, and in Wedgewood's jasper ware.

Illustrated, too, are some beautiful examples of the art of the potter, applied to coffee service, as found in the Metropolitan Museum, where they have been brought from many countries. Included are Leeds and Staffordshire examples of the eighteenth, nineteenth, and twentieth centuries; a Sino-Lowestoft pot of the eighteenth-nineteenth century; an Italian (*capodimonte*) pot of the eighteenth century; German pots of the eighteenth and nineteenth centuries; a Vienna coffee pot of the eighteenth century; a French (*La Seime*) coffee pot of 1774-1793, a Sèvres pot of 1792-1804; and a Spanish eighteenth-century coffee pot decorated in copper luster.

At the Metropolitan may be seen also Hatfield and Sheffield-plate pots of the eighteenth and nineteenth centuries; and many examples of silver tea and coffee service and coffee pots by American silversmiths.

Silver teapots and coffee pots were few in America before the middle of the eighteenth century. Early coffee-pot examples were tapering and cylindrical in form, and later matched the tea pots with swelling drums, molded bases, decorated spouts, and molded lids with finials.



VIENNA COFFEE POT, 1830  
In the Metropolitan Museum of Art

From notes by R. T. Haines Halsey and John H. Buck, collected by Florence N. Levy and woven into an introduction to the Metropolitan Museum's art exhibition catalog for the Hudson-Fulton celebration of 1909, we learn that:

The first silver made in New England was probably fashioned by English or Scotch emigrants who had served their time abroad. They were followed by craftsmen who were either born here, or, like John Hull, arriving at an early age, learned their trade on this side.

In England it was required that every master goldsmith should have his mark and set it upon his work after it was assayed and marked with the king's mark (hall-mark) testifying to the fineness of the metal.

The Colonial silversmiths marked their wares with their initials, with or without emblems, placed in shields, circles, etc., without any guide as to place of manufacture or date. After about 1725 it was the custom to use the surname, with or without an initial, and sometimes the full name. Since the establishment of the United States the name of the town was often added and also the letters D or C in a circle, probably meaning dollar or coin, show-

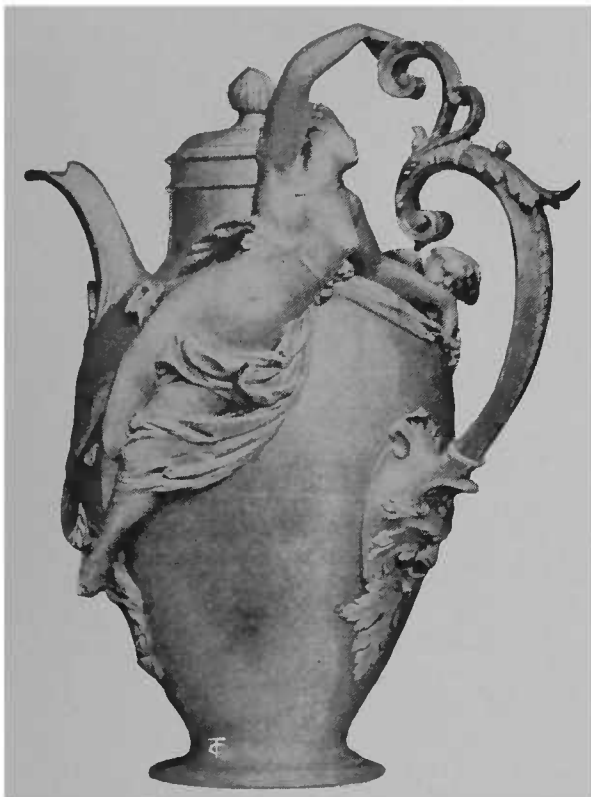


COFFEE POT BY WM. SHAW AND WM. PRIEST  
Made for Peter Faneuil (about 1751-52), who gave his name to Boston Faneuil Hall, which has been called the cradle of American liberty.



POT OF SHEFFIELD PLATE, 18TH CENTURY  
In the Metropolitan Museum

SILVER POT BY EPHRAIM BRASHER  
In the Clearwater Collection, Metropolitan Museum



FRENCH SILVER COFFEE POT  
Grand Prize, Union Centrale, 1886

ing the standard or coin from which the wares were made.

In the New York colony there were evolved silver teapots of a unique design, that was not used elsewhere in the colonies. Mr. Halsey says they were used indiscriminately for both tea and coffee. In style they followed, to a certain extent, the squat pear-shaped tea pots of the period of 1717-18 in England, but had greater height and capacity.

The colonial silversmiths wrought many beautiful designs in coffee, tea, and chocolate pots. Fine specimens are to be seen in the Halsey and Clearwater loan collections in the Metropolitan Museum. Included in the Clearwater collection is a coffee pot by Pygan Adams (1712-1776); and recently, there was added a coffee pot by Ephraim Brasher, whose name appears in the *New York City Directory* from 1786 to 1805. He was a member of the Gold and Silversmiths' Society, and he made the die for the famous gold doubloon, known by his name, a specimen of which was sold in Philadelphia for \$4,000. His brother, Abraham Brasher, who was an officer in the continental army, wrote many popular ballads of the Revolutionary period, and was

a constant contributor to the newspapers.

The Clearwater collection of colonial silver in the Metropolitan Museum is a magnificent one; and the coffee pot is worthy of it. It is thirteen and one-half inches high, weighs forty-four ounces, exclusive of the ebony handle, has a curved body and splayed base, with a godrooned band to the base and a similar edge to the cover. The spout is elaborate and curved; the cover has an urn-shaped finial; and there is a decoration of an engraved medallion surrounded by a wreath with a ribbon forming a true lover's knot.

In the Halsey collection is shown a silver coffee pot by Samuel Minott, and several beautiful specimens of the handiwork of Paul Revere, whose name is more often connected with the famous "midnight ride" than with the art of the silversmith. Of all the American silversmiths, Paul Revere was the most interesting. Not only was he a silversmith of renown, but a patriot, soldier, grand master Mason, confidential agent of the state of Massachusetts Bay, engraver, picture-frame designer, and die-sinker. He was born in Boston in 1735, and died in 1818. He was the most famous of all the Boston silversmiths, although he



THE GREEN DRAGON TAVERN COFFEE URN



By an unknown silversmith

By Paul Revere

By Paul Revere

## COFFEE POTS BY AMERICAN SILVERSMITHS

is more widely known as a patriot. He was the third of a family of twelve children, and early entered his father's shop. When only nineteen, his father died; but he was able to carry on the business. The engraving on his silver bears witness to his ability. He engraved also on copper, and made many political cartoons. He joined the expedition against the French at Crown Point, and in the war of the Revolution was a lieutenant-colonel of artillery. After the

close of the war, he resumed his business of a goldsmith and silversmith in 1783. Decidedly a man of action, he well played many parts; and in all his manifold undertakings achieved brilliant success. There clings, therefore, to the articles of silver made by him an element of romantic and patriotic association which endears them to those who possess them.

Revere had a real talent that enabled him to impart an unwonted elegance to his



TWENTIETH-CENTURY AMERICAN COFFEE SERVICE  
The Portsmouth Pattern, by the Gorham Co.



work, and he was famous as an engraver of the beautiful crests, armorial designs, and floral wreaths that adorn much of his work. His teapots and coffee pots are beautiful.

Revere coffee pots are to be seen in the Boston Museum of Fine Arts as well as in the Metropolitan Museum in New York. The Boston Museum of Fine Arts has also a coffee pot made by William Shaw and William Priest in 1751-52 for Peter Faneuil, the wealthiest Bostonian of his time, who gave his name to Boston Faneuil Hall, New England's cradle of American liberty.

Among other American silversmiths who produced striking designs in coffee pots, mention should be made of G. Aiken (1815); Garrett Eoff (New York, 1785-1850); Charles Faris (who worked in Boston about 1790); Jacob Hurd (1702-1758, known in Boston as Captain Hurd); John McMullin (mentioned in the Philadelphia *Directory* for 1796); James Musgrave (mentioned in Philadelphia directories of 1797, 1808, and 1811); Myer Myers (admitted as freeman, New York, 1746; active until 1790; president of the New York Silversmiths Society, 1786); and Anthony Rasch (who is known to have worked in Philadelphia, 1815).

In the museums of the many historical societies throughout the United States are to be seen interesting specimens of coffee pots in pewter, Britannia metal, and tin

ware, as well as in pottery, porcelain, and silver. Some of these are illustrated.

As in other branches of art during the seventeenth and eighteenth centuries, the United States was indebted to England, Holland, and France for much of the early pottery and porcelain. Elers, Astbury, Whieldon, Wedgwood, their imitators, and the later Staffordshire potters, flooded the American market with their wares. Porcelain was not made in this country previous to the nineteenth century. Decorative pottery was made here, however, from an early period. Britannia ware began to take the place of pewter in 1825; and the introduction of japanned tin ware and pottery gradually caused the manufacture of pewter to be abandoned.

An interesting relic is in the collection of the Bostonian Society. It is a coffee urn of Sheffield ware, formerly in the Green Dragon tavern, which stood on Union Street from 1697 to 1832, and was a famous meeting place of the patriots of the Revolution. It is globular in form, resting on a base; and inside is still to be seen the cylindrical piece of iron which, when heated, kept the delectable liquid contents of the urn hot until imbibed by the frequenters of the tavern. The iron bar was set in a zinc or tin jacket to keep such fire-place ashes as still clung to it from coming in contact with the coffee, which was probably brewed in a stew kettle be-



TURKISH COFFEE SET, PETER COLLECTION, UNITED STATES NATIONAL MUSEUM, WASHINGTON

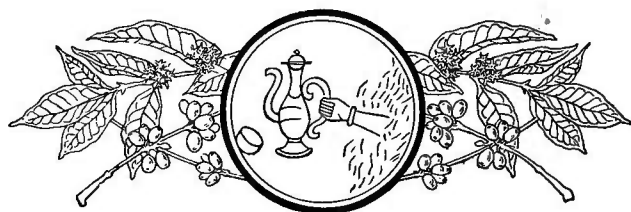
fore being poured into the urn for serving. The Green Dragon tavern site, now occupied by a business structure, is owned by the St. Andrew's Lodge of Freemasons of Boston; and at a recent gathering of the lodge on St. Andrew's Day, the urn was exhibited to the assembled brethren.

When the contents of the tavern were sold, the urn was bought by Mrs. Elizabeth Harrington, who then kept a famous boarding-house on Pearl Street, in a building owned by the Quincy family. The house was razed in 1847, being replaced by the Quincy Block. Mrs. Harrington removed to High Street, and from there to Chauncey Place. Some of the prominent men of Boston boarded with her for many years. At her death, the urn was given to her daughter, Mrs. John R. Bradford. It was presented to the society by Miss Phebe C. Bradford, of Boston, granddaughter of Mrs. Elizabeth Harrington.

A somewhat similar urn, made of pewter, is in the Museum of the Maine Historical Society of Portland, Me.; another in the

Museum of the Essex Institute at Salem, Mass.

Among the many treasured relics of Abraham Lincoln is an old Britannia coffee pot from which he was regularly served while a boarder with the Rutledge family at the Rutledge inn in New Salem (now Menard), Ill. It was a valued utensil, and Lincoln is said to have been very fond of it. The pot is now the property of the Old Salem Lincoln League, of Petersburg, Ill., and was donated to it, with other relics, by Mrs. Saunders, of Sisquoc, Cal., the only surviving child of James and Mary Ann Rutledge. Mrs. Rutledge carefully preserved this and other relics of New Salem days; and shortly before her death in 1878, she gave them into the keeping of her daughter, Mrs. Saunders, advising her to preserve them until such time as a permanent home for them would be provided by a grateful people back at New Salem, where they were associated with the immortal Lincoln and his tragic romance with her daughter Ann.



---

# A COFFEE CHRONOLOGY

Giving Dates and Events of Historical Interest in Legend, Travel, Literature, Cultivation, Plantation Treatment, Trading, and in the Preparation and Use of Coffee from the Earliest Time to the Present

\* Approximate date.

† Legendary.

---

- 900\***—Rhazes, famous Arabian physician, is first writer to mention coffee, calling it *bunca* or *bunchum*.†
- 1000\***—Avicenna, Mohammedan physician and philosopher, is the first writer to explain the medicinal properties of the coffee bean, which he also calls *bunchum*.†
- 1258\***—Sheik Omar, disciple of Sheik Schadheli, patron saint and legendary founder of Mocha, by chance discovers coffee as a heverage at Ousah in Arabia.†
- 1300\***—The coffee drink is a decoction made from roasted berries, crushed in a mortar and pestle, the powder being placed in boiling water, and drink taken down, grounds and all.
- 1350\***—Persian, Egyptian, and Turkish ewers made of pottery are first used for serving coffee.
- 1400-1500**—Earthenware or metal coffee-roasting plates with small holes, rounded and shaped like a skimmer, come into use in Turkey and Persia over braziers. Also about this time appears the familiar Turkish cylinder coffee mill, and the original Turkish coffee boiler of metal.
- 1428-48**—Spice grinder to stand on four legs first invented; subsequently used to grind coffee.
- 1454\***—Sheik Gemaledin, mufti of Aden, having discovered the virtues of the berry on a journey to Abyssinia, sanctions the use of coffee in Arabia Felix.
- 1470-1500**—The use of coffee spreads to Mecca and Medina.
- 1500-1600**—Shallow iron dippers with long handles and small foot-rests come into use in Bagdad and in Mesopotamia for roasting coffee.
- 1505\***—The Arabs introduce the coffee plant into Ceylon.
- 1510**—The coffee drink is introduced into Cairo.
- 1511**—Kair Bey, governor of Mecca, after consultation with a council of lawyers, physicians, and leading citizens, issues a condemnation of coffee, and prohibits the use of the drink. Prohibition subsequently ordered revoked by the sultan of Cairo.
- 1517**—Sultan Selim I, after conquering Egypt, brings coffee to Constantinople.
- 1524**—The kadi of Mecca closes the public coffee houses because of disorders, but permits coffee drinking at home and in private. His successor allows them to re-open under license.
- 1530\***—Coffee drinking introduced into Damascus.
- 1532\***—Coffee drinking introduced into Aleppo.
- 1534**—A religious fanatic denounces coffee in Cairo and leads a mob against the coffee houses, many of which are wrecked. The city is divided into two parties, for and against coffee; but the chief judge, after consultation with the doctors, causes coffee to be served to the meeting, drinks some himself, and thus settles the controversy.
- 1542**—Soliman II, at the solicitation of a favorite court lady, forbids the use of coffee, but to no purpose.
- 1554**—The first coffee houses are opened in Constantinople by Shemsî of Damascus and Hekem of Aleppo.
- 1570\*-80\***—Religious zealots in Constantinople, jealous of the increasing popularity of the coffee houses, claim roasted coffee to be a kind of charcoal, and the mufti decides that it is forbidden by the law. Amurath III subsequently orders the closing of all coffee houses, on religious grounds, classing coffee with wine, forbidden by the *Koran*. The order is not strictly observed, and coffee drinking continues behind closed shop-doors and in private houses.
- 1573**—Rauwolf, German physician and botanist, first European to mention coffee, makes a journey to the Levant.
- 1580**—Prospero Alpini (Alpinus), Italian physician and botanist, journeys to Egypt and brings back news of coffee.
- 1582-83**—The first printed reference to coffee appears as *chaube* in Rauwolf's *Travels*, published in German at Frankfort and Lauingen.
- 1585**—Gianfrancesco Morosini, city magistrate in Constantinople, reports to the Venetian senate the use by the Turks "of a black water, being the infusion of a bean called *cavee*."
- 1587**—The first authentic account of the origin of coffee is written by the Sheik Abd-al-Kadir, in an Arabian manuscript preserved in the Bibliothèque Nationale, Paris.
- 1592**—The first printed description of the coffee plant (called *bon*) and drink (called *caova*) appears in Prospero Alpini's work *The Plants of Egypt*, written in Latin, and published in Venice.
- 1596\***—Belli sends to the botanist de l'Écluse "seeds used by the Egyptians to make a liquid they call *cave*."
- 1598**—The first printed reference to coffee in English appears as *chaoua* in a note of Paludanus in *Linschooten's Travels*, translated from the Dutch, and published in London.
- 1599**—Sir Antony Sherley, first Englishman to refer to coffee drinking in the Orient, sails from Venice for Aleppo.
- 1600\***—Pewter serving-pots appear.
- 1600**—Iron spiders on legs, designed to sit in open fires, are used for roasting coffee.
- 1600\***—Coffee cultivation introduced into southern India at Chickmaglur, Mysore, by a Moslem pilgrim, Baha Budan.†
- 1600-32**—Mortars and pestles of wood, and of metal (iron, bronze, and brass) come into common use in Europe for making coffee powder.
- 1601**—The first printed reference to coffee in English, employing the more modern form of the word, appears in W. Parry's book, *Sherley's Travels*, as "a certain liquor which they call coffe."
- 1603**—Captain John Smith, English adventurer, and founder of the colony of Virginia, in his book of travels published this year, refers to the Turks' drink, "coffa."
- 1610**—Sir George Sandys, the poet, visits Turkey, Egypt, and Palestine, and records that the Turks "sip a drink called *coffa* (of the berry that it is made of) in little china dishes, as hot as they can suffer it."

- 1614**—Dutch traders visit Aden to examine into the possibilities of coffee cultivation and coffee trading.
- 1615**—Pietro Della Valle writes a letter from Constantinople to his friend Mario Schipano at Venice that when he returns he will bring with him some coffee, which he believes "is a thing unknown in his native country."
- 1615**—Coffee is introduced into Venice.
- 1616**—The first coffee is brought from Mocha to Holland by Pieter Van dan Broecke.
- 1620**—Peregrine White's wooden mortar and pestle (used for "hraying" coffee) is brought to America on the Mayflower by White's parents.
- 1623-27**—Francis Bacon, in his *Historia Vitae et Mortis* (1623), speaks of the Turks' "caphe"; and in his *Sylvarum Sylvarum* (1627) writes: "They have in Turkey a drink called *coffa* made of a herry of the same name, as black as soot, and of a strong scent. . . . this drink comfortheth the brain and heart, and helpth digestion."
- 1625**—Sugar is first used to sweeten coffee in Cairo.
- 1632**—Burton in his *Anatomy of Melancholy* says: "The Turks have a drink called *coffa*, so named from a herry black as soot and as bitter."
- 1634**—Sir Henry Blount makes a voyage to the Levant, and is invited to drink "cauphe" in Turkey.
- 1637**—Adam Olearius, German traveler and Persian scholar, visits Persia (1633-39); and on his return tells how in this year he observed that the Persians drink *chawa* in their coffee houses.
- 1637**—Coffee drinking is introduced into England by Nathaniel Conopios, a Cretan student at Balliol College, Oxford.
- 1640**—Parkinson, in his *Theatrum Botanicum*, publishes the first hotanical description of the coffee plant in English—referred to as "*Arbor Bon cum sua Bana*. The Turkes Berry Drink."
- 1640**—The Dutch merchant, Wurffbain, offers for sale in Amsterdam the first commercial shipment of coffee from Mocha.
- 1644**—Coffee is introduced into France at Marseilles by P. de la Roque, who brought back also from Constantinople the instruments and vessels for making it.
- 1645**—Coffee comes into general use in Italy.
- 1645**—The first coffee house is opened in Venice.
- 1647**—Adam Olearius publishes in German his *Persian Voyage Description*, containing an account of coffee manners and customs in Persia in 1633-39.
- 1650\***—Varnar, Dutch minister resident at the Ottoman Porte, publishes a treatise on coffee.
- 1650\***—The individual hand-turned metal (tin-plate or tinned copper) roaster appears; shaped like the Turkish coffee grinder, for use over open fires.
- 1650**—The first coffee house in England is opened at Oxford by Jacobs, a Jew.
- 1650**—Coffee is introduced into Vienna.
- 1652**—The first London coffee house is opened by Pasqua Rosée in St. Michael's Alley, Cornhill.
- 1652**—The first printed advertisement for coffee in English appears in the form of a handbill issued by Pasqua Rosée, acclaiming "The Vertue of the Coffee Drink."
- 1656**—Grand Vizier Kuprili, during the war with Candia, and for political reasons, suppresses the coffee houses and prohibits coffee. For the first violation the punishment is cudgeling; for a second, the offender is sewn up in a leather hag and thrown into the Bosphorus.
- 1657**—The first newspaper advertisement for coffee appears in *The Publick Adviser* of London.
- 1657**—Coffee is introduced privately into Paris by Jean de Thévenot.
- 1658**—The Dutch begin the cultivation of coffee in Ceylon.
- 1660\***—The first French commercial importation of coffee arrives in haies at Marseilles from Egypt.
- 1660**—Coffee is first mentioned in the English statute books when a duty of four pence is laid upon every gallon made and sold "to be paid by the maker."
- 1660\***—Nieuhoff, Dutch ambassador to China, is the first to make a trial of coffee with milk, in imitation of tea with milk.
- 1660**—Elford's "white iron" machine for roasting coffee is much used in England, being "turned on a spit by a jack."
- 1662**—Coffee is roasted in Europe over charcoal fires without flame, in ovens, and on stoves; being "browned in uncovered earthenware tart dishes, old pudding pans, fry pans."
- 1663**—All English coffee houses are required to be licensed.
- 1663**—Regular imports of Mocha coffee begin at Amsterdam.
- 1665**—The improved Turkish long brass combination coffee grinder with folding handle and cup receptacle for green beans, for boiling and serving, is first made in Damascus. About this period the Turkish coffee set, including long-handled hoiler and porcelain cups in brass holders, comes into vogue.
- 1668**—Coffee is introduced into North America.
- 1669**—Coffee is introduced publicly into Paris by Soliman Aga, the Turkish ambassador.
- 1670**—Coffee is roasted in larger quantities in small closed sheet-iron cylinders having long iron handles designed to turn them into open fireplaces. First used in Holland. Later, in France, England, and the United States.
- 1670**—The first attempt to grow coffee in Europe at Dijon, France, results in failure.
- 1670**—Coffee is introduced into Germany.
- 1670**—Coffee is first sold in Boston.
- 1671**—The first coffee house in France is opened in Marseilles in the neighborhood of the Exchange.
- 1671**—The first authoritative printed treatise devoted solely to coffee, written in Latin by Faustus Nairon, professor of Oriental languages, Rome, is published in that city.
- 1671**—The first printed treatise in French largely devoted to coffee, *Concerning the Use of Coffee, Tea, and Chocolate*, by Philippe Sylvestre Dufour, is published at Lyons.
- 1672**—Pascal, an Armenian, first sells coffee publicly at St.-Germain's fair, Paris, and opens the first Parisian coffee house.
- 1672**—Great silver coffee pots (with all the utensils belonging to them of the same metal) are used at St.-Germain's fair, Paris.
- 1674**—*The Women's Petition Against Coffee* is published in London.
- 1674**—Coffee is introduced into Sweden.
- 1675**—Charles II issues a proclamation to close all London coffee houses as places of sedition. Order revoked on petition of the traders in 1676.
- 1679**—An attempt by the physicians of Marseilles to discredit coffee on purely dietetic grounds fails of effect; and consumption increases at such a rate that traders in Lyons and Marseilles begin to import the green bean by the shipload from the Levant.
- 1679\***—The first coffee house in Germany is opened by an English merchant at Hamburg.
- 1683**—Coffee is sold publicly in New York.
- 1683**—Kolschitzky opens the first coffee house in Vienna.
- 1685**—*Café au lait* is first recommended for use as a medicine by Sieur Monin, a celebrated physician of Grenoble, France.

- 1686**—John Ray, one of the first English botanists to extol the virtues of coffee in a scientific treatise, publishes his *Universal Botany of Plants* in London.
- 1686**—The first coffee house is opened in Regensburg, Germany.
- 1689**—Café de Procope, the first real French café, is opened in Paris by François Procope, a Sicilian, coming from Florence.
- 1689**—The first coffee house is opened in Boston.
- 1691**—Portable coffee-making outfits to fit the pocket find favor in France.
- 1692**—The "lantern" straight-line coffee pot with true cone lid, thumb-piece, and handle fixed at right angle to the spout, is introduced into England, succeeding the curved Oriental serving pot.
- 1694**—The first coffee house is opened in Leipzig, Germany.
- 1696**—The first coffee house (The King's Arms) is opened in New York.
- 1696**—The first coffee seedlings are brought from Kananur, on the Malabar coast, and introduced into Java at Kedawoeng, near Batavia, but not long afterward are destroyed by flood.
- 1699**—The second shipment of coffee plants from Malabar to Java by Henricus Zwaardcroon becomes the progenitors of all the *arabica* coffee trees in the Netherlands Indies.
- 1699**—Galland's translation of the earliest Arabian manuscript on coffee appears in Paris under the title, *Concerning the First Use of Coffee and the Progress It Afterward Made*.
- 1700**—Ye coffee house, the first in Philadelphia, is built by Samuel Carpenter.
- 1700-1800**—Small portable coke or charcoal stoves made of sheet-iron, and fitted with horizontal revolving cylinders turned by hand, come into use for family roasting.
- 1701**—Coffee pots appear in England with perfect domes and bodies less tapering.
- 1702**—The first "London" coffee house is established in Philadelphia.
- 1704**—Bull's machine for roasting coffee, probably the first to use coal for commercial roasting is patented in England.
- 1706**—The first samples of Java coffee, and a coffee plant grown in Java, are received at the Amsterdam botanical gardens.
- 1707**—The first coffee periodical, *The New and Curious Coffee House*, is issued at Leipzig by Theophilus Georgi, as a kind of organ of the first kaffee-klatsch.
- 1711**—Java coffee is first sold at public auction in Amsterdam.
- 1711**—A novelty in coffee-making is introduced into France by infusing the ground beans in a fustian (linen) bag.
- 1712**—The first coffee house is opened in Stuttgart, Germany.
- 1713**—The first coffee house is opened in Augsburg, Germany.
- 1714**—The thumb-piece on English coffee pots disappears, and the handle is no longer set at a right angle to the spout.
- 1714**—A coffee plant, raised from seed of the plant received at the Amsterdam botanical gardens in 1706, is presented to Louis XIV of France, and is nurtured in the Jardin des Plantes, Paris.
- 1715**—Jean La Roque publishes in Paris his *Voyage de l'Arabie Heureuse* (voyage to Arabia the Happy) containing much valuable information on coffee in Arabia and its introduction into France.
- 1715**—Coffee cultivation is introduced into Haiti and Santo Domingo.
- 1715-17**—Coffee cultivation is introduced into the Isle of Bourbon (now Réunion) by a sea captain of St. Malo, who brings the plants from Mocha by direction of the French Company of the Indies.
- 1718**—Coffee cultivation is introduced into Surinam (Dutch Guiana).
- 1718**—Abbé Massieu's *Carmen Caffaeum*, the first and most notable poem on coffee written in Latin, is composed, and is read before the Academy of Inscriptions.
- 1720**—Caffè Florian is opened in Venice by Floriano Francesconi.
- 1721**—The first coffee house is opened in Berlin, Germany.
- 1721**—Meisner publishes a treatise on coffee, tea, and chocolate.
- 1722**—Coffee cultivation is introduced into Cayenne from Surinam.
- 1723**—The first coffee plantation started in the Portuguese colony of Pará, Brazil, with plants brought from Cayenne (French Guiana) results in failure.
- 1723**—Gahriel de Clieu, Norman captain of infantry, sails from France, accompanied by one of the seedlings of the Java tree presented to Louis XIV, and with it shares his drinking water on a protracted voyage to Martinique.
- 1727**—Seeds and shoots of the coffee plant are brought to Pará, the Portuguese colony at the mouth of the Amazon, from Cayenne, French Guiana, beginning the first successful commercial introduction of coffee cultivation in Brazil.
- 1730**—The English bring the cultivation of coffee to Jamaica.
- 1732**—The British Parliament seeks to encourage the cultivation of coffee in British possessions in America by reducing the inland duty.
- 1732**—Bach's celebrated *Coffee Cantata* is published in Leipzig.
- 1737**—The Merchants' coffee house is established in New York; by some called the true cradle of American liberty and the birth-place of the Union.
- 1740**—Coffee culture is introduced into the Philippines from Java by Spanish missionaries.
- 1746**—A royal edict is issued in Sweden against "the misuse and excesses of tea and coffee drinking."
- 1748**—Coffee cultivation is introduced into Cuba by Don José Antonio Gelahert.
- 1750**—Coffee cultivation is introduced into Celebes from Java.
- 1750**—The straight-line coffee pot in England begins to give way to the reactionary movement in art favoring bulbous bodies and serpentine spouts; the sides are nearly parallel, while the dome of the lid is flattened to a slight elevation above the rim.
- 1750-60**—Coffee cultivation is introduced into Guatemala.
- 1752**—Intensive coffee cultivation is resumed in the Portuguese colonies in Pará and Amazonas, Brazil.
- 1754**—A white-silver coffee roaster, eight inches high by four inches in diameter, is mentioned as being among the deliveries made to the army of Louis XV at Versailles.
- 1755**—Coffee cultivation is introduced into Puerto Rico from Martinique.
- 1756**—Coffee drinking is prohibited by royal decree in Sweden, but coffee bootlegging and loss of taxes ultimately force removal of the ban.
- 1760**—Decoction, or boiling, of coffee in France is generally replaced by the infusion method.
- 1760**—João Alberto Castello Branco plants in Rio de Janeiro a coffee tree brought to Brazil from Goa, Portuguese India.
- 1761**—Brazil exempts coffee from export duty.



- 1763**—Donmartin, a tinsmith of St. Benoit, France, invents a novel coffee pot, the inside of which is "filled by a fine flannel sack put in in its entirety." It has a tap to draw the coffee.
- 1764**—Count Pietro Verri publishes in Milan, Italy, a philosophic and literary periodical, entitled *Il Caffè* (the coffee house).
- 1765**—Mme. de Pompadour's golden coffee mill is mentioned in her inventory.
- 1770**—Complete revolution in style of English serving pots; return to the flowing lines of the Turkish ewer.
- 1770**—Chicory is first used with coffee in Holland.
- 1770-73**—Coffee cultivation begins in Rio, Minas, and São Paulo.
- 1771**—John Dring is granted a patent in England for a compound coffee.
- 1774**—Molke, a Belgian monk, introduces the coffee plant from Surinam into the garden of the Capuchin monastery at Rio de Janeiro.
- 1774**—A letter is sent by the Committee of Correspondence from the Merchants' coffee house, New York, to Boston, proposing the American Union.
- 1775-76**—The Venetian Council of Ten bans coffee houses on the ground of immorality, vice, and corruption. However, they survive all attempts to suppress them.
- 1777**—King Frederick the Great of Prussia issues his celebrated coffee and beer manifesto, recommending the use of the latter in place of the former among the lower classes.
- 1779**—Richard Dearman is granted an English patent for a new method of making mills for grinding coffee.
- 1779**—Coffee cultivation is introduced into Costa Rica from Cuba by the Spanish voyager, Navarro.
- 1781**—King Frederick the Great of Prussia establishes state coffee-roasting plants in Germany, declares the coffee business a government monopoly, and forbids the common people to roast their own coffee. "Coffee-smellers" make life miserable for violators of the law.
- 1784**—Coffee cultivation is introduced into Venezuela by seed from Martinique.
- 1784**—A prohibition against the use of coffee, except by the rich, is issued by Maximilian Frederick, elector of Cologne.
- 1785**—Governor Bowdoin of Massachusetts introduces chicory to the United States.
- 1789**—The first import duty on coffee, two and a half cents a pound, is levied by the United States.
- 1789**—George Washington is officially greeted, April 23, as president-elect of the United States at the Merchants' coffee house in New York.
- 1790**—Coffee cultivation is introduced into Mexico from the West Indies.
- 1790**—The first wholesale coffee-roasting plant in the United States begins operation at 4 Great Dock Street, New York.
- 1790**—The first United States advertisement for coffee appears in the *New York Daily Advertiser*.
- 1790**—The import duty on coffee in the United States is increased to four cents a pound.
- 1790**—The first crude package coffee is sold in "narrow mouthed stoneware pots and jars," by a New York merchant.
- 1791**—John Hopkins, an English merchant, exports the first coffee from Rio de Janeiro to Lisbon, Portugal.
- 1792**—The Tontine coffee house is established in New York.
- 1794**—The import duty on coffee in the United States is increased to five cents a pound.
- 1798**—The first United States patent for an improved coffee-grinding mill is granted to Thomas Bruff, Sr.
- 1800\***—Chicory comes into use in Holland as a substitute for coffee.
- 1800\***—De Belloy's coffee pot, made of tin, later of porcelain, appears—the original French drip coffee pot.
- 1800\*-1900\***—There is a return in England to the style of coffee-serving pot having the handle at right angle to the spout.
- 1802**—The first French patent on a coffee maker is granted to Denobe, Henrion, and Rouch for "a pharmacological-chemical coffee making device by infusion."
- 1802**—Charles Wyatt is granted a patent in London on an apparatus for distilling coffee.
- 1804\***—The first cargo of coffee—and other East Indian produce—from Mocha, to be shipped in an American bottom, reaches Salem, Mass.
- 1806**—James Henckel is granted a patent in England on a coffee drier, "an invention communicated to him by a certain foreigner."
- 1806**—The first French patent on an improved French drip coffee pot for making coffee by filtration, without boiling, is granted to Hadrot.
- 1806**—The coffee percolator (really an improved French drip coffee pot) is invented by Count Rumford (Benjamin Thompson), an expatriated American scientist, in Paris.
- 1808**—Coffee is cultivated in a small way around Cúcuta, Colombia, having been introduced from Venezuela in the last half of the eighteenth century.
- 1809**—The first importation of Brazil coffee by the United States arrives at Salem, Mass.
- 1809**—Coffee becomes an article of commerce in Brazil.
- 1811**—Walter Rochfort, a London grocer and tea dealer, obtains a patent in London on a compressed coffee tablet.
- 1812**—Coffee in England is roasted in an iron pan or hollow cylinder made of sheet iron; and then is pounded in a mortar, or ground in a hand-mill.
- 1812**—Anthony Schick is granted an English patent on a method, or process, for roasting coffee, for which specifications were never enrolled.
- 1812**—Coffee is roasted in Italy in a glass flask with a loose cork, held over a clear fire of burning coals and continually agitated.
- 1812**—The import duty on coffee in the United States is increased to ten cents a pound as a war-revenue measure.
- 1813**—A United States patent is granted Alexander Duncan Moore, New Haven, Conn., on a mill for grinding and pounding coffee.
- 1814**—A war-time fever of speculation in tea and coffee causes the citizens of Philadelphia to form a non-consumption association, each member pledging himself not to pay more than twenty-five cents a pound for coffee, and not to use tea unless it is already in the country.
- 1816**—The import duty on coffee in the United States is reduced to five cents a pound.
- 1817\***—The coffee biggin (said to have been invented by a man named Biggin) comes into common use in England.
- 1818**—The Havre coffee market for spot coffee and to arrive is established.
- 1819**—Morize, a Paris tinsmith, invents a double drip reversible coffee pot.
- 1819**—Laurens is granted a French patent on the original pumping-percolator device in which the boiling water was raised by steam pressure and sprayed over the ground coffee.
- 1820**—Peregrine Williamson, Baltimore, is granted the first United States patent for an improvement on a coffee roaster.

- 1820**—Another early form of the French percolator is patented by Gaudet, a Paris tinsmith.
- 1822**—Nathan Reed, Belfast, Me., is granted a United States patent on a coffee huller.
- 1824**—Richard Evans is granted a patent in England for a commercial method of roasting coffee, comprising a cylinder sheet-iron roaster fitted with improved flanges for mixing, a hollow tube and trier for sampling the coffee while roasting, and a means for turning the roaster completely over to empty it.
- 1825**—The pumping percolator, worked by steam pressure and partial vacuum, comes into vogue in France, Germany, Austria, and elsewhere.
- 1825**—The first coffee-pot patent in the United States is issued to Lewis Martelly, New York.
- 1825**—Coffee cultivation is introduced into Hawaii from Rio de Janeiro.
- 1827**—The first patent for a really practicable French coffee percolator is granted to Jacques Augustin Gandais, a manufacturer of plated jewelry in Paris.
- 1828**—Charles Parker, Meriden, Conn., begins work on the original Charles Parker coffee mill.
- 1829**—The first French patent on a coffee mill is granted Colaux et Cie, Molsheim, France.
- 1829**—Établissements Lauzanne begin the manufacture of hand-turned cylinder coffee roasting machines in Paris.
- 1830**—The import duty on coffee in the United States is reduced to two cents a pound.
- 1831**—David Selden is granted a patent in England for a coffee-grinding mill having cones of cast iron.
- 1831**—John Whitmee & Co., England, begin the manufacture of coffee-plantation machinery.
- 1831**—The import duty on coffee in the United States is reduced to one cent a pound.
- 1832**—A United States patent is granted to Edmund Parker and Herman M. White, Meriden, Conn., on a new household coffee and spice mill. (Chas. Parker Co. business founded same year.)
- 1832**—Government coffee cultivation by forced labor is introduced into Java.
- 1832**—Coffee is placed on the free list in the United States.
- 1832-33**—United States patents are granted to Ammi Clark, Berlin, Conn., on improved coffee and spice mills for household use.
- 1833**—Amos Ransom, Hartford, Conn., is granted a United States patent on a coffee roaster.
- 1833-34**—A complete English coffee-roasting-and-grinding plant is installed in New York by James Wild.
- 1834**—This year marks the earliest recorded exportation of coffee from Colombia.
- 1834**—John Chester Lyman is granted a patent in England on a coffee huller employing circular wooden disks with wire teeth.
- 1835**—Thomas Ditson, Boston, is granted a United States patent on a coffee huller. Ten others follow.
- 1835**—The first private coffee estates are started in Java and Sumatra.
- 1836**—The first French coffee-roaster patent is issued to François René Lacoux, Paris, on a combination coffee roaster and grinder made of porcelain.
- 1837**—The first French coffee substitute is patented by François Buriel, Lyons.
- 1839**—James Vardy and Moritz Platow are granted an English patent on a form of urn percolator, employing the vacuum process of coffee making, the upper vessel being made of glass.
- 1840**—Coffee cultivation is introduced into El Salvador.
- 1840**—Central America begins shipping coffee to the United States.
- 1840\***—Robert Napier, of the Clyde engineering firm of Robert Napier & Sons, invents the Napierian vacuum coffee machine to make coffee by distillation and filtration, but the idea is never patented. (See 1870.)
- 1840**—Abel Stillman, Poland, N. Y., is granted a United States patent on a family coffee roaster having a mica window to enable the operator to observe the coffee while roasting.
- 1840**—The English begin to cultivate coffee in India.
- 1840**—Wm. McKinnon & Co., Aberdeen, Scotland, begin the manufacture of plantation machinery. (Established 1798.)
- 1842**—The first French patent on a glass coffee-making device is granted to Mme. Vassieux of Lyons.
- 1843**—Ed. Loysel de Santais, Paris, is granted a patent on an improved coffee-making device, the principle of which is later incorporated in a hydrostatic percolator making 2,000 cups an hour.
- 1846**—James W. Carter, Boston, is granted a United States patent on the Carter "pull-out" coffee roaster.
- 1847**—J. R. Remington, Baltimore, is granted a United States patent on a coffee roaster employing a wheel of buckets to move the green coffee beans singly through a charcoal-heated trough in which they are roasted while passing over the rotating wheel.
- 1847-48**—William Dakin and Elizabeth Dakin are granted patents in England for a roasting cylinder lined with gold, silver, platinum, or alloy, and traversing carriage on a railway to move the roaster in and out of the heating chamber.
- 1848**—Thomas John Knowlys is granted a patent in England on a perforated roasting cylinder coated with enamel.
- 1848**—Luke Herbert is granted the first English patent on a coffee-grinding machine.
- 1849**—Apoleoni Preterre, Havre, is granted a patent in England on a coffee roaster mounted on a weighing apparatus to indicate loss of weight in roasting, and automatically to stop the roasting process.
- 1849**—Thomas R. Wood of Cincinnati is granted a United States patent on Wood's improved spherical coffee roaster for use on kitchen stoves.
- 1850**—John Gordon & Co., begin the manufacture of coffee-plantation machinery in London.
- 1850\***—The cultivation of coffee is introduced into Guatemala.
- 1850\***—John Walker introduces his cylinder pulper for coffee plantations.
- 1852**—Edward Gee secures a patent in England for an improved combination of apparatus for roasting coffee; having a perforated cylinder fitted with inclined flanges for turning the beans while roasting.
- 1852**—Robert Bowman Tennent is granted a patent in England on a two-cylinder machine for pulping coffee. Others follow.
- 1852**—Tavernier is granted a French patent on a coffee tablet.
- 1853**—Lacassagne and Latchoud are granted a French patent on liquid and solid extracts of coffee.
- 1855**—C. W. Van Vliet, Fishkill Landing, N. Y., is granted a patent on a household coffee mill employing upper breaking and lower grinding, cones. Assigned to Charles Parker, Meriden, Conn.
- 1856**—Waite and Sener's Old Dominion pot is patented in the United States.
- 1857**—The Newell patents on coffee-cleaning machinery are issued in America. Sixteen patents follow.
- 1857**—George L. Squier, Buffalo, N. Y., begins the manufacture of coffee-plantation machinery.

- 1859—John Gordon, London, is granted an English patent on a coffee pulper.
- 1860\*—Osborn's Celebrated Prepared Java coffee, the pioneer ground-coffee package, is put on the New York market by Lewis A. Osborn.
- 1860—Marcus Mason, an American mechanical engineer in San José, Costa Rica, invents the Mason pulper and cleaner.
- 1860—John Walker is granted a patent in England on a disk pulper for pulping Arabian coffee.
- 1860—Alexius van Gülpen begins the manufacture of green-coffee-grading machine at Emmerich, Germany.
- 1861—An import duty of four cents a pound on coffee is imposed by the United States as a war-revenue measure.
- 1862—The import duty on coffee in the United States is increased to five cents a pound.
- 1862—The first paper-bag factory in the United States, making bags for loose coffee, begins operation in Brooklyn.
- 1862—E. J. Hyde, Philadelphia, is granted a United States patent on a combined coffee roaster and stove, fitted with a crane on which the roasting cylinder is revolved and swung out horizontally from the stove.
- 1864—Jabez Burns, New York, is granted a United States patent on the Burns coffee roaster, the first machine that did not have to be moved away from the fire for discharging the roasted coffee—marking a distinct advance in the manufacture of coffee-roasting apparatus.
- 1864—James Henry Thompson, Hoboken, and John Lidgerwood, Morristown, N. J., are granted an English patent on a coffee-hulling machine.
- 1865—John Arbuckle introduces to the trade at Pittsburgh roasted coffee in individual packages, the forerunner of the "Ariosa" package.
- 1866—William Van Vleek Lidgerwood, American chargé d'affaires, Rio de Janeiro, is granted an English patent on a coffee-hulling-and-cleaning machine.
- 1867—Jabez Burns is granted United States patents on a coffee cooler, a coffee mixer, and a grinding mill, or granulator.
- 1868—Thomas Page, New York, begins the manufacture of a pull-out coffee roaster similar to the Carter machine.
- 1868—Alexius van Gülpen, in partnership with J. H. Lensing and Theodor von Gimborn, begins the manufacture of coffee-roasting machines at Emmerich, Germany.
- 1868—E. B. Manning, Middletown, Conn., patents his tea-and-coffee pot in the United States.
- 1868—John Arbuckle is granted a United States patent for a roasted-coffee coating consisting of Irish moss, isinglass, gelatin, sugar, and eggs.
- 1869—Élie Moneuse and L. Duparquet, New York, are granted three United States patents on a coffee pot, or urn, formed of sheet copper and lined with pure sheet block tin.
- 1869—B. G. Arnold, New York, engineers the first large green-coffee speculation; his success as an operator winning for him the title of King of the Coffee Trade.
- 1869—Henry E. Smyser, assignor to the Weikel & Smith Spice Co., Philadelphia, is granted his first United States patent on a spice box used also for coffee.
- 1869—Licenses to sell coffee in London are abolished.
- 1869—Coffee-leaf disease attacks the plantations in Ceylon.
- 1870—John Gulick Baker, Philadelphia, one of the founders of the Enterprise Manufacturing Co. of Pennsylvania, is granted a patent on a coffee grinder introduced to the trade by the Enterprise Manufacturing Co. as its "Champion No. 1" mill.
- 1870—Delephine, Sr., Marourme, is granted a French patent on a tubular coffee roaster that turns over the flame.
- 1870—Alexius van Gülpen, Emmerich, Germany, brings out a globular coffee roaster having perforations and an exhauster.
- 1870—Thos. Smith & Son, Glasgow, Scotland (Elkington & Co., successors), begin the manufacture of the Napierian vacuum coffee-making machines for brewing coffee by distillation.
- 1870—First United States trade-mark for essence of coffee is registered by Butler, Earhart & Co., Columbus, Ohio.
- 1870—The first coffee valorization enterprise in Brazil results in failure.
- 1871—J. W. Gillies, New York, is granted two patents in the United States for roasting and treating coffee by subjecting it to an intervening cooling operation.
- 1871—First United States trade-mark for coffee is issued to Butler, Earhart & Co., Columbus, Ohio, for "Buckeye," first used in 1870.
- 1871—G. W. Hungerford is granted United States patents on coffee-cleaning-and-polishing machines.
- 1871—The import duty on coffee in the United States is reduced to three cents a pound.
- 1872—Jabez Burns, New York, is granted a United States patent on an improved coffee-granulating mill. Another in 1874.
- 1872—J. Guardiola, Chocoma, Guatemala, is granted his first United States patents on a coffee pulper and a coffee drier.
- 1872—The import duty on coffee in the United States is repealed.
- 1872—Robert Hewitt, Jr., New York, publishes the first American work on coffee, *Coffee: Its History, Cultivation, and Uses*.
- 1873—J. G. Baker, Philadelphia, assignor of the Enterprise Manufacturing Co. of Pennsylvania, is granted a United States patent on a grinding mill later known to the trade as "Enterprise Champion Globe No. 0."
- 1873—Marcus Mason begins the manufacture of coffee-plantation machinery in the United States.
- 1873—"Ariosa," first successful national brand of package coffee is put on the United States market by John Arbuckle of Pittsburgh. (Registered 1900.)
- 1873—H. C. Lockwood, Baltimore, is granted a United States patent on a coffee package made of paper and lined with tin-foil.
- 1873—The first international syndicate to control coffee is organized in Frankfort, Germany, by the German Trading Company, and operates successfully for eight years.
- 1873—The Jay Cooke stock-market panic causes the price of Rios in the New York market to drop from twenty-four cents to fifteen cents in one day.
- 1873—E. Dugdale, Griffin, Ga., is granted two United States patents on coffee substitutes.
- 1873—The first "coffee palace," the Edinburgh Castle, designed to replace public-houses for workmen, is opened in London.
- 1874—John Arbuckle is granted a United States patent on a coffee-cleaner-and-grader.
- 1875—Coffee cultivation is introduced into Guatemala.
- 1875-76-78—Turner Strowbridge, of New Brighton, Pa., is granted three United States patents on a box coffee mill first made by Logan & Strowbridge.
- 1876—John Manning brings out his valve-type percolator in the United States.
- 1876-78—Henry B. Stevens, Buffalo, assignor to George L. Squier, Buffalo, is granted important United States patents on coffee-cleaning-and-grading machines.

- 1877—The first German patent on a commercial coffee roaster is issued in Berlin to G. Tuberman's Son.
- 1877—A French patent is granted Marchand and Hignette, Paris, on a sphere or ball coffee roaster.
- 1877—The first French patent on a gas coffee roaster is issued to Roure of Marseilles.
- 1878—Coffee cultivation is introduced into British Central Africa.
- 1878—*The Spice Mill*, the first paper in America devoted to the coffee and spice trades, is founded by Jabez Burns in New York.
- 1878—A United States patent is issued to Rudolphus L. Webb, assignor to Landers, Frary & Clark of New Britain, Conn., on an improved box coffee grinder for home use.
- 1878—Chase & Sanborn, the Boston coffee roasters, are the first to pack and ship roasted coffee in sealed containers.
- 1878—John C. Dell, Philadelphia, is granted a United States patent on a coffee mill for store use.
- 1878—Coffee cultivation is begun by the British in Central Africa.
- 1879—H. Faulder, Stockport, Lancaster, Eng., is granted an English patent on the first English gas coffee roaster, now made by the Grocers Engineering & Whitmee, Ltd.
- 1879—A new gas coffee roaster is invented in England by Fleury & Barker.
- 1879—C. F. Hargreaves, Rio de Janeiro, is granted an English patent on machinery for hulling, polishing, and separating coffee.
- 1879—Charles Halstead, New York, is the first to bring out a metal coffee pot with a china interior.
- 1879-80—Orson W. Stowe, of the Peck, Stowe & Wilcox Co., Southington, Conn., is granted United patents on an improved coffee and spice mill.
- 1880—Great failures in the American coffee trade as a result of syndicate planting and buying of coffees in Brazil, Mexico, and Central America.
- 1880—Coffee pot with tops, having muslin bottoms for clarifying and straining, are first made by Duparquet, Huot & Moneuse Co. in the United States.
- 1880—Peter Pearson, Manchester, Eng., is granted a patent in England on a coffee roaster wherein gas is substituted for coke as fuel.
- 1880—Henry E. Smyser, Philadelphia, is granted a United States patent on a package-making-and-filling machine, forerunner of the weighing-and-packing machine, the control of which by John Arbuckle led to the coffee-sugar war with the Havemeyers.
- 1880—Fancy paper bags for coffee are first used in Germany.
- 1880-81—G. W. and G. S. Hungerford are granted United States patents on machines for cleaning, scouring, and polishing coffee.
- 1880-81—The first big coffee-trade combination in North America, known as the "trinity" (O. G. Kimball, B. G. Arnold and Bowie Dash, all of New York), has a sensational collapse, its failure being the result of syndicate planting and buying of coffees in Brazil, Mexico, and Central America.
- 1881—Steele & Price, Chicago, are the first to introduce all-paper cans (made of strawboard) for coffee.
- 1881—C. S. Phillips, Brooklyn, is granted three patents in the United States for aging and maturing coffee.
- 1881—The Emmericher Maschinenfabrik und Eisengiesserei at Emmerich, Germany, begins the manufacture of a closed globular roaster with a gas-heater attachment.
- 1881—Jabez Burns is granted a United States patent on an improved construction of his roaster, comprising a turn-over front head, serving for both feeding and discharging.
- 1881—The Morgan brothers, Edgar H. and Charles, begin the manufacture of household coffee mills, subsequently acquired (1885) by the Arcade Manufacturing Co., Freeport, Ill.
- 1881—Francis B. Thurber, New York, publishes the second important American work on coffee, *Coffee from Plantation to Cup*.
- 1881—Harvey Ricker, Brooklyn, introduces to the trade a "minute" coffee pot and urn, known as the "Boss," name subsequently changed to "Minute," and later improved and patented (1901) as the "Half Minute" coffee pot—a filtration device employing a cotton sack with a thick bottom.
- 1881—New York Coffee Exchange is incorporated.
- 1882—Chris. Abele, New York, is granted a patent in the United States on an improvement on a coffee roaster, similar to the original Burns machine (on which the 1864 patent had expired) known as the Knickerbocker.
- 1882—The Hungerfords, father and son, bring out a coffee roaster, similar to the first Burns machine, in competition with Chris. Abele.
- 1882—A German patent is granted to Emil Newstadt, Berlin, on one of the earliest coffee-extract-making machines.
- 1882—The first French coffee exchange, or terminal market is opened at Havre.
- 1882—New York Coffee Exchange begins business.
- 1883—The Burns Improved Sample Coffee Roaster is patented in the United States by Jabez Burns.
- 1884—The "Star" coffee pot, later known as the "Marion Harland," is introduced to the trade.
- 1884—The Chicago Liquid Sack Co. introduces the first combination paper and tin-end can for coffee in the United States.
- 1885—F. A. Cauchois introduces into the United States market an improved porcelain-lined coffee urn.
- 1885—Property of New York Coffee Exchange is transferred to the Coffee Exchange, City of New York, incorporated by special charter.
- 1885—Coffee cultivation is introduced into the Belgian Congo.
- 1886—Walker, Sons & Co., Ltd., begin experiments in Ceylon with a Liberian disk coffee pulper; fully perfected in 1898.
- 1886-88—The "great coffee boom" forces the price of Rio 7's from seven and a half to twenty-two and a quarter cents, the subsequent panic reducing the price to nine cents. Total sales on the New York Coffee Exchange, 1887-88, amount to 47,868,750 bags; and prices advance 1,485 points during 1886-87.
- 1887—Beeston Tupholme, London, is granted a patent in England on a direct-flame gas coffee roaster.
- 1887—Coffee cultivation is introduced into Tonkin, Indo-China.
- 1887—Coffee exchanges are opened in Amsterdam and Hamburg.
- 1888—The abolition of slavery in Brazil wrecks the coffee industry and paves the way for the fall of the monarchy, which is succeeded by a republic in 1889.
- 1888—Evaristo Conrado Engelberg, Piracicaba, São Paulo, Brazil, is granted a United States patent on a coffee-hulling machine (invented in 1885); and the same year, the Engelberg Huller Co., Syracuse, N. Y., is organized for the purpose of manufacturing and selling Engelberg machines.
- 1888—Karel F. Henneman, the Hague, Netherlands, is granted a patent in Spain on a direct-flame gas coffee roaster.
- 1888—A French patent is granted to Postulart on a gas roaster.
- 1889—David Fraser, who came to the United States in

- 1886 from Glasgow, Scotland, establishes the Hungerford Co., succeeding to the business of the Hungerfords.
- 1889—The Arcade Manufacturing Co., Freeport, Ill., brings out the first "pound" coffee mill.
- 1889—Karel F. Henneman, the Hague, Netherlands, is granted patents in Belgium, France, and England, on his direct-flame gas coffee roaster.
- 1889—C. A. Otto is granted a German patent on a spiral-coil gas coffee machine to roast coffee in three and a half minutes.
- 1890—A. Mottant, Bar-le-Duc, France, begins the manufacture of coffee-roasting machines.
- 1890\*—Coffee exchanges are opened in Antwerp, London, and Rotterdam.
- 1890—Sigmund Kraut begins the manufacture of fancy grease-proof paper-lined coffee bags in Berlin.
- 1891—The New England Automatic Weighing Machine Co., Boston, begins the manufacture of machines to weigh coffee into cartons and other packages.
- 1891—R. F. E. O'Krassa, Antigua, Guatemala, is granted an important English patent on a machine for pulping coffee.
- 1891—John List, Black Heath, Kent, Eng., is granted an English patent on a steam coffee urn described as an improvement on the Napierian system.
- 1892—T. von Gimborn, Emmerich, Germany, is granted an English patent on a coffee roaster employing a naked gas flame in a rotary cylinder.
- 1892—The Fried. Krupp A. G. Grusonwerk, Magdeburg-Buckau, Germany, begins the manufacture of coffee-plantation machinery.
- 1893—Cirilo Mingo, New Orleans, is granted a United States patent on a process for maturing, or aging green coffee beans by moistening the bags.
- 1893—The first direct-flame gas coffee roaster in America (Tupholme's English machine) is installed by F. T. Holmes at the plant of the Potter-Parlin Co., New York, which places similar machines on daily rental basis throughout the United States, limiting leases to one firm in a city, obtaining exclusive American rights from the Waygood, Tupholme Co., now the Whitmee Engineering Company, Ltd., London.
- 1893—Karel F. Hennemann, the Hague, Netherlands, is granted a United States patent on his direct-flame gas coffee roaster.
- 1894—The first automatic weighing machine to weigh goods in cartons is installed in the plant of Chase & Sanborn, Boston.
- 1894—Joseph M. Walsh, Philadelphia, publishes his *Coffee; Its History, Classification and Description*.
- 1895—Gerritt C. Otten and Karel F. Henneman, the Hague, Netherlands, are granted a United States patent on a coffee roaster.
- 1895—Adolph Kraut introduces German-made double (grease-proof lined) paper bags for coffee in America.
- 1895—Marcus Mason, assignor to Marcus Mason & Co., New York, is granted United States patents on machines for pulping and polishing coffee.
- 1895—Thomas M. Royal, Philadelphia, is the first to manufacture in the United States a fancy duplex-lined paper bag.
- 1895—Edelstan Jardin publishes in Paris work on coffee, entitled *Le Caf  ier et le Caf  *.
- 1895—The Electric Scale Co., Quincy, Mass., begins the manufacture of pneumatic weighing machines; business continued by the Pneumatic Scale Corp., Ltd., Norfolk Downs, Mass.
- 1895—The Henneman direct-flame gas coffee roaster, a Dutch machine, is introduced into the United States by C. A. Cross, Fitchburg, Mass.
- 1896—Natural gas is first used in the United States as fuel for roasting, being introduced under coal roasting cylinders in Pennsylvania and Indiana by improvised gas-burners.
- 1896—Coffee is planted experimentally in Kenya, East Africa.
- 1896—1897—Beeston Tupholme is granted United States patents on his direct-flame gas coffee roaster.
- 1896—Coffee cultivation is introduced into Queensland, Australia, in a small way.
- 1897—Joseph Lambert of Vermont begins the manufacture and sale in Battle Creek, Mich., of the Lambert self-contained coffee roaster without the brick setting then required for coffee roasting machines.
- 1897—A special gas burner (made the basis of application for patent) is first attached to a regular Burns roaster.
- 1897—The Enterprise Manufacturing Co., Pennsylvania, is the first regularly to employ electric motors for driving commercial coffee mills by means of belt-and-pulley attachments.
- 1897—Carl H. Duehring, Hoboken, N. J., assignor to D. B. Fraser, New York, is granted a United States patent on a coffee roaster.
- 1898—The Hobart Manufacturing Co., Troy, Ohio, puts on the market one of the first coffee grinders connected with an electric motor and driven by a belt-and-pulley attachment.
- 1898—Millard F. Hamsley, Brooklyn, is granted a United States patent on an improved direct-flame gas coffee roaster.
- 1898—Edwin Norton of New York is granted a United States patent on a vacuum process of canning foods, later applied to coffee. Others follow.
- 1898—J. A. Olavarria, a distinguished Venezuelan, first advocates a plan for restriction of coffee production, and for regulation of coffee exports from countries suffering from overproduction.
- 1898—A bear campaign forces Rio 7's down to four and a half cents on the New York Coffee Exchange.
- 1899—The hubonic-plague boom temporarily halts the downward trend of coffee prices.
- 1899—The Canister Co., Phillipsburg, N. J., begins the manufacture of square and oblong fiber-bodied tin-end cans for coffee.
- 1899—Soluble coffee is invented in Chicago by Dr. Sartori Kato, a chemist of Tokio.
- 1899—David B. Fraser, New York, is granted two patents in the United States, one for a coffee roaster and one for a coffee cooler.
- 1899—Ellis M. Potter, New York, is granted a United States patent on a direct-flame gas coffee roasting machine embodying certain improvements on the Tupholme machine, whereby the gas flame is spread over a large area, so avoiding scorching and securing a more thorough and uniform roast.
- 1900—The Burns direct-flame gas coffee roaster with a patented swing-gate head for feeding and discharging at the center, is first introduced to the trade.
- 1900—First gear-driven electric coffee grinder is introduced into the United States market by the Enterprise Manufacturing Co. of Pennsylvania.
- 1900—The Burns swing-gate sample-coffee roasting outfit is patented in the United States.
- 1900—Hills Bros., San Francisco, are the first to pack coffee in a vacuum under the Norton patents.
- 1900—Charles Morgan, Freeport, Ill., is granted a United States patent on a glass-jar coffee mill with removable glass measuring cup.
- 1900—R. F. E. O'Krassa, Antigua, Guatemala, is granted English and a United States patents on machines for shelling and drying coffee.
- 1900—Chemically purified and neutralized rosin as a glaze



- (*hars-glasur*) for roasted coffee, designed to keep it fresh and palatable, is first discovered and applied in Germany.
- 1900—Charles Lewis is granted a United States patent on his "Kin Hee" filter coffee pot.
- 1900—Coffee cultivation on a commercial scale is begun in Kenya.
- 1900—1901—A new era in coffee is inaugurated when Santos permanently displaces Rio as the world's largest source of supply.
- 1901—Kato's soluble coffee is put on the United States market by the Kato Coffee Company at the Pan-American Exposition in Buffalo.
- 1901—American Can Co. begins the manufacture and sale of tin coffee cans in the United States.
- 1901—Improved all-paper cans for coffee (made of straw-board or chip-board, plain or manila-lined) are introduced into the United States market by J. H. Kuechenmeister of St. Louis.
- 1901—The first issue of *The Tea and Coffee Trade Journal*, devoted to the interests of the tea and coffee trades, appears in New York.
- 1901—Coffee cultivation is introduced into British East Africa from Réunion Island.
- 1901—Robert Burns of New York is granted two United States patents on a coffee roaster and cooler.
- 1901—Joseph Lambert of Marshall, Mich., introduces to the trade in the United States a gas coffee roaster, one of the earliest machines employing gas as fuel for indirect roasting.
- 1901—T. C. Morewood, Brentford, Middlesex, Eng., is granted an English patent on a gas coffee roaster with a removable sampling tube.
- 1901—F. T. Holmes joins the Huntley Manufacturing Co., Silver Creek, N. Y., which then begins to build the "Monitor" coffee roaster for the trade.
- 1901—Landers, Frary & Clark's Universal percolator is patented in the United States.
- 1902—The Coles Manufacturing Co. (Braun Co., successors) and Henry Troemner, Philadelphia, begin the manufacture and sale of gear-driven electric coffee grinders.
- 1902—The Pan-American Congress, meeting in Mexico City, proposes an international congress for the study of coffee, to meet in New York, October, 1902.
- 1902—An international coffee congress is held in New York, October 1 to October 30.
- 1902—*Robusta* coffee is introduced into Java from the Jardin Botanique at Brussels.
- 1902—The first fancy duplex paper bag made by machinery from a roll of paper is produced by the Union Bag & Paper Corp.
- 1902—The Jagenberg Machine Co. begins the introduction into the United States of a line of German-made automatic packaging-and-labeling machines for coffee.
- 1902—T. K. Baker, Minneapolis, is granted two United States patents on a cloth-filter coffee maker.
- 1903—A United States patent on a coffee concentrate and process of making the same (soluble coffee) is granted to Sartori Kato of Chicago, assignor to the Kato Coffee Company of Chicago.
- 1903—F. A. Cauchois introduces Coffey's soluble coffee to the United States coffee trade, the product being ground roasted coffee mixed with sugar and reduced to a powder.
- 1903—Overproduction in Brazil causes Santos 4's to drop to 3.55 cents on the New York Exchange, the lowest price ever recorded for coffee.
- 1903—John Arbuckle, New York, is granted a United States patent on a coffee-roasting apparatus, employing a fan to force the "hot fire gases" into the roasting cylinder.
- 1903—George C. Lester, New York, is granted a United States patent on an electric coffee roaster.
- 1904—Dr. E. Denekamp is granted a United States patent on a rosin glaze for roasted coffee, designed to preserve its flavor and aroma.
- 1904—The so-called "cotton crowd," under the leadership of D. J. Sully, forces green-coffee prices up to 11.85 cents, all records for business on the New York Coffee Exchange being smashed by the sale of over a million bags on February 5.
- 1904—Sigmund Sternau, J. P. Steppe, and L. Strassberger, assignors to S. Sternau & Co., New York, are granted a United States patent on a coffee percolator.
- 1904—05—Douglas Gordon, assignor to Marcus Mason & Co., New York, is granted United States patents on a coffee pulper and a coffee drier.
- 1905—The A. J. Deer Co., Buffalo (now at Hornell, N. Y.), begins the sale of its "Royal" electric coffee mills direct to dealers, on the instalment plan, revolutionizing the former practice of selling coffee mills through the hardware jobbers.
- 1905—H. L. Johnston is granted a United States patent on a coffee mill which he assigns to the Hobart Manufacturing Co., Troy, Ohio.
- 1905—Frederick A. Cauchois introduces his "Private Estate" coffee maker, a filtration device employing Japanese filter paper.
- 1905—Finley Acker, Philadelphia, is granted a United States patent on a coffee percolator, employing "porous or bibulous paper" as a filtering medium and having side perforations.
- 1905—A coffee exchange is opened in Trieste, Austria-Hungary.
- 1905—The Kaffee-Handels Aktiengesellschaft, Bremen, is granted a German patent on a process for freeing coffee from caffeine.
- 1906—H. D. Kelly, Kansas City, Mo., is granted a United States patent on the "Kellum Thermo-Automatic" coffee urn, employing a coffee extractor in which the ground coffee is continually agitated before percolation by a vacuum process. Sixteen patents follow.
- 1906—G. Washington, an American chemist born in Belgium of English parents, living temporarily in Guatemala City, invents a refined soluble coffee.
- 1906—Frank T. Holmes, Brooklyn, assignor to the Huntley Manufacturing Co., is granted a patent for an improvement on a coffee-roasting machine.
- 1906—Captain Moegling's electric-fuel coffee roaster, invented in 1900, is given a practical demonstration in Germany.
- 1906—Ludwig Schmidt, assignor to the Essmueller Mill Furnishing Co., St. Louis, is granted a United States patent on a coffee roaster.
- 1906—The first convention of coffee states in Brazil is held at Taubate, São Paulo, February 29th.
- 1906—07—Brazil produces a record-breaking crop of 20,190,000 bags, and the State of São Paulo inaugurates a plan to valorize coffee.
- 1907—The Pure Food and Drugs Act comes into force in the United States, making it obligatory to label all coffees correctly.
- 1907—Desiderio Pavoni, Milan, is granted a patent in Italy for an improvement on the Bezzara system of preparing and serving coffee as a rapid infusion of a single cup.
- 1907—P. E. Edtbauer (Mrs. E. Edtbauer), Chicago, is granted a United States patent on a duplex automatic weighing machine, the first simple, fast, accurate, and moderate-priced machine for weighing coffee.
- 1908—Dr. John Friederick Meyer, Jr., Ludwig Roselius, and Karl Heinrich Wimmer, are granted a United States patent on a process for freeing coffee of caffeine.
- 1908—Brazil begins a propaganda for coffee in England

- by subsidizing an English company organized for that purpose.
- 1908**—Puerto Rico coffee planters present a memorial to the Congress of the United States asking for a protective tariff of six cents a pound on all foreign coffee.
- 1908**—The revivification of the valorization coffee enterprise is accomplished by a combination of hankers and the Brazil Government, with a loan of \$75,000,000 placed through Hermann Sielcken with hanking houses in England, Germany, France, Belgium, and the United States.
- 1908**—J. C. Prims, of Battle Creek, Mich., patents a corrugated-cylinder improvement for a gas-and-coal coffee roaster of small capacity (50 to 130 pounds) designed for retail stores.
- 1908**—An improved type of Burns roaster, comprising an open perforated cylinder with flexible back head and balanced front hearing, is granted a patent in the United States.
- 1908**—I. D. Richheimer, Chicago, introduces his "Tricolator," an improved device employing Japanese filter paper.
- 1908-11**—R. F. E. O'Kassa, Antigua, Guatemala, is granted several English patents on machines for hulling, washing, drying, and separating coffee.
- 1909**—The G. Washington refined prepared soluble coffee is put on the United States market.
- 1909**—The A. J. Deer Co. acquires the Prims coffee roaster and re-introduces it to the trade as the "Royal" coffee roaster.
- 1909**—The Burns tilting sample-coffee roaster is patented in the United States for gas or electric heating units.
- 1909**—Frederick A. Cauchois of New York is granted a United States patent on a coffee urn fitted with a centrifugal pump for re-pouring.
- 1909**—C. F. Blanke, St. Louis, is granted two United States patents on a china coffee pot with a dripper hag.
- 1910**—The German caffeine-free coffee is first introduced to the trade of the United States by Merck & Co., New York, under the brand name Dekafa, later changed to Dekofa.
- 1910**—B. Belli publishes in Milan, Italy, work on coffee entitled *Il Caffè*.
- 1910**—Frank Bartz, assignor to the A. J. Deer Co., Hornell, N. Y., is granted two United States patents on flat and concave coffee-grinding disks provided with concentric rows of inclined teeth, used in electric coffee mills.
- 1911**—All-fiber, parchment-lined, "Dampite" cans for coffee are introduced by the American Can Company.
- 1911**—The coffee roasters of the United States organize a national association.
- 1911**—Robert H. Talhutt, Baltimore, assignor to J. E. Baines, trustee, Washington, is granted a United States patent on an electric coffee roaster.
- 1911**—Edward Ahorn, New York, introduces his "Make-Right" coffee filter, and is granted a United States patent on it.
- 1912**—Robert O'Kassa, Antigua, Guatemala, is granted four United States patents on machines for washing, drying, separating, hulling, and polishing coffee.
- 1912**—The C. F. Blanke Tea & Coffee Co., St. Louis, brings out "Magic Cup," later known as "Faust Soluble," coffee.
- 1912**—The United States government brings suit to force the sale of coffee stocks held in the United States under the valorization agreement.
- 1912**—John E. King, Detroit, is granted a United States patent on an improved coffee percolator employing a filter-paper attachment.
- 1912**—Delivery of Rohusta coffee on contracts is prohibited by the New York Coffee and Sugar Exchange.
- 1913**—F. F. Wear, Los Angeles, Cal., perfects a coffee-making device in which a metal perforated clamp is employed to apply a filter paper to the under side of an English earthenware adaptation of the French drip pot.
- 1913**—F. Lehnoff Wyld, Guatemala City, and E. T. Caharrus organize the "Société du Café Soluble Belna," Brussels, Belgium, to put on the European market a refined soluble coffee under the brand name "Belna."
- 1913**—Herbert L. Johnston, assignor to the Hobart Electric Manufacturing Co., Troy, Ohio, is granted a United States patent on a machine for refining coffee.
- 1914**—The Associated Nationale du Commerce des Cafés is established at 5 Place Jules Ferry, Havre, to protect the interests of the coffee trade of all France.
- 1914**—The Kaffee Hag Corporation, capital \$1,000,000, is organized in New York to continue marketing in the United States the German caffeine-free coffee under its original German brand name.
- 1914**—Robert Burns of New York, assignor to Jabez Burns & Sons, is granted a United States patent on a coffee-granulating mill.
- 1914**—The "Phylax" coffee maker, employing an improved French-drip principle, is introduced to the trade by the Phylax Coffee Maker Co., Detroit, succeeded in 1922 by the Phylax Company of Pennsylvania.
- 1914**—The first national coffee week is promoted in the United States by the National Coffee Roasters Association.
- 1914-15**—Herbert Galt, Chicago, is granted three United States patents on the Galt coffee pot, all aluminum, having two parts; a removable cylinder employing the French-drip principle, and the containing pot.
- 1915**—The Burns "Jubilee" inner-heated gas coffee roaster is patented in the United States and put on the market.
- 1915**—The National Coffee Roasters Association Home coffee mill, employing a set screw operating on a cog-and-ratchet principle, is introduced to the trade.
- 1915**—The second national coffee week is held in the United States under the auspices of the National Coffee Roasters Association.
- 1916**—The Federal Tin Co. begins the manufacture of tin coffee containers for use in connection with automatic packing machines.
- 1916**—The National Paper Can Co., Milwaukee, introduces to the United States trade a new hermetically sealed all-paper can for coffee.
- 1916**—A United States patent is granted to I. D. Richheimer, Chicago, for an improvement on his "Tricolator."
- 1916**—The Coffee Trade Association, London, is formed to include brokers, merchants, and wholesale dealers.
- 1916**—The Coffee Exchange, City of New York, changes its name to the New York Coffee and Sugar Exchange, admitting sugar trading.
- 1916**—Saul Blickman, assignor to S. Blickman, New York, is granted a United States patent on an apparatus for making and dispensing coffee.
- 1916**—Orville W. Chamberlain, New Orleans, is granted a United States patent on an automatic drip coffee pot.
- 1916**—Jules Le Page, Darlington, Ind., is granted two United States patents on cutting-rolls to cut, and not grind or crush, coffee, later marketed by the B. F. Gump Co., Chicago, as the "Ideal" steel-cut coffee mill.
- 1916-17**—The first hermetically-sealed all-paper cans for coffee are introduced to the United States trade (patented in 1919 by the National Paper Can Co., Milwaukee).
- 1917**—The Baker Importing Co., Minneapolis and New York, puts on the United States market "Barrington Hall" soluble coffee.
- 1917**—Richard A. Greene and William G. Burns, New York, assignors to Jabez Burns & Sons, are granted patents in the United States on the Burns flexible-arm

- cooler (for roasted batches), providing full fan-suction connection to a cooler box at all points in its track travel.
- 1918—John E. King, Detroit, Mich., is granted a United States patent on an irregular-grind of coffee, consisting of coarsely grinding ten per cent of the product and finely grinding ninety per cent.
- 1918—The Charles G. Hires Co., Philadelphia, brings out Hires soluble coffee.
- 1918—I. D. Richheimer, promoter of the original soluble coffee of Kato, and the Kato patent, organizes the Soluble Coffee Company of America to supply soluble coffee to the American army overseas; after the armistice, licensing other merchants under the Kato patents, or offering to process the merchants' own coffee for them, if desired.
- 1918—The United States government places coffee importers, brokers, jobbers, roasters, and wholesalers under a war-time licensing system to control imports and prices.
- 1918—A frost of unprecedented severity in the State of São Paulo, Brazil, does great damage to the coffee blossoms with consequent reduction of crop.
- 1918-19—The United States government coffee control results in the accumulation at Brazil ports of more than 9,000,000 bags; in spite of which, Brazil speculators force Brazil grades up to 75 to 100 per cent, costing United States traders millions of dollars.
- 1919—The Kaffee Hag Corporation becomes Americanized by the sale of 5,000 shares of its stock sold by the alien property custodian and the purchase of the remaining 5,000 shares by George Gund, Cleveland, Ohio.
- 1919—William A. Hamor and Charles W. Trigg, Pittsburgh, Pa., assignors to John E. King, Detroit, Mich., are granted a United States patent on a process for making a new soluble coffee. The process consists in bringing the volatilized caffeol in contact with a petrolatum absorbing medium, where it is held until needed for combination with the evaporated coffee extract.
- 1919—Floyd W. Robison, Detroit, is granted a United States patent on a process for aging green coffee by treating it with micro-organisms to improve its flavor and to increase its extractive value. The product is put on the market as Cultured coffee.
- 1919—William Fullard, Philadelphia, is granted a United States patent on a "heated fresh air system" for roasting coffee.
- 1919—A million-dollar propaganda for coffee is begun in the United States by Brazil planters in cooperation with a joint coffee-trade publicity committee.
- 1920—The third national coffee week is observed in the United States, this time under the auspices of the Joint Coffee Trade Publicity Committee.
- 1920—Edward Aborn, New York, is granted a United States patent on a "Tru-Bru" coffee pot, a device embodying improvements on the French drip principle.
- 1920—Alfredo M. Salazar, New York, is granted a United States patent on a coffee urn in which the coffee is made at the time of serving by using steam pressure to force the boiling water through the ground coffee held in a cloth sack attached to the faucet.
- 1920—The Joint Coffee Trade Publicity Committee starts a campaign to feature iced coffee in the United States.
- 1920—Professor S. C. Prescott of the Massachusetts Institute of Technology begins a scientific investigation of the properties of coffee, under the auspices of the Joint Coffee Trade Publicity Committee.
- 1920—The Coffee Club, a national organization of wholesale and retail coffee dealers, with headquarters in New York, is organized to advance the work of the Joint Coffee Trade Publicity Committee.
- 1920—William H. Pisani, assignor to M. J. Brandenstein & Co., San Francisco, is granted a United States patent on a vacuum process for packing roasted coffee.
- 1920—The Rio de Janeiro Coffee Exchange is inaugurated.
- 1921—The Comité Français du Café is founded in France to increase the consumption of coffee.
- 1921—The U. S. Bureau of Chemistry, Department of Agriculture, rules that only *Coffea arabica* grown in the island of Java can be sold as "Java" coffee.
- 1921—The first direct shipment, 23,000 bags, of coffee from Brazil to Boston is carried by the SS. "Liberty Glow."
- 1922—The São Paulo legislature at the solicitation of the Sociedade Promotora da Defeza do Café passes a bill increasing the export tax on coffee from Santos to 200 reis per bag to continue the propaganda for coffee in the United States for three years.
- 1922—A mission composed of Walter Jones, Wallace Morley, Robert Meyer, and Felix Coste, representing the National Coffee Roasters Association, visits Brazil.
- 1922—*All About Coffee*, by William H. Ukers, M.A., the first serious work on coffee in English in 30 years, is published in October.
- 1922—Lewis S. Baker, Ossining, N. Y., patents in the United States a two-piece vacuum-type automatic coffee maker.
- 1922—Henry Roselius, Amsterdam, Holland, takes out a United States patent on a process for removing caffeine from coffee; and Louis Angell Romero, San Francisco, patents a process for making coffee extract.
- 1923—Professor S. C. Prescott's final report to the Joint Coffee Trade Publicity Committee on his researches into the properties of coffee shows that coffee is a wholesome, helpful, satisfying drink for the great majority of people.
- 1923—A gold medal is awarded to William H. Ukers for his book *All About Coffee* by the Brazil Centennial Exposition.
- 1923—Coffee cultivation is introduced by the Italian Government into Eritrea, Africa.
- 1923—Edward Aborn, New York, is granted a United States patent on a filter coffee pot, and Isaac D. Richheimer, New York, patents an individual-cup infuser for coffee.
- 1924—The National Coffee Trade Council is organized in the United States to bring the green-coffee men and the coffee roasters into a single guiding body.
- 1924—Cyrus F. Blanke, St. Louis, patents in the United States a coffee pot; Coffee Products Corporation, New York, a process for preparing caffeine-free coffee beans; Hobart Manufacturing Co., Troy, Ohio, a coffee grinder; and Albert P. Grohens, Marshall, Mich., two coffee roasters.
- 1924—The Brazilian Government transfers its coffee defense to the State of São Paulo.
- 1925—Trading in washed Robustas is permitted by the New York Coffee and Sugar Exchange.
- 1925—Wm. G. Burns and Harry Russell Maxon, assignors to Jabez Burns & Sons, Inc., New York, are granted a United States patent on a coffee roaster and means of discharging the roast. Also, Richard A. Greene, assignor to Jabez Burns & Sons, Inc., patents a plurality of roasting cylinders with independent discharges.
- 1925—William A. Lamb, assignor to the Silex Co., Malden, Mass., patents in the United States a coffee maker and heating device; Ernest H. Still, London, Eng., a pressure infuser for coffee; and George H. Peal, Rutherford, N. J., a perforated coffee infuser with string and tag.
- 1925—A delegation of American coffee men, composed of Berent Friele, F. J. Ach, and Felix Coste, visits Brazil to arrange for the resumption of coffee advertising in the United States.
- 1926—The State of São Paulo floats a £10,000,000 loan in London.
- 1926—*The Tea and Coffee Trade Journal* celebrates its silver anniversary with a special issue (September).
- 1927—The American-Brazilian Association is formed to

promote commercial relations between Brazil and the United States.

- 1927**—Brazil celebrates the second centennial of the introduction of coffee cultivation.
- 1927**—J. L. Kopf, assignor to Jabez Burns & Sons, Inc., patents a method of coffee granulation.
- 1927**—Gorham Manufacturing Co., Providence, patents in the United States an electric percolator; Fritz Kündig, Switzerland, a process for producing caffeine-free coffee; Sloss Perfect Coffee Makers, Inc., New York, an urn combination; and Compact Coffee Corporation, Delaware, a coffee tablet.
- 1928**—Isaac D. Richheimer, New York, is granted a United States patent on a non-drizzle coffee-pot spout; Charles E. Page, Los Angeles, a drip pot; and Albert W. Meyer, New York, an individual-cup coffee brewer.
- 1929**—The Brazilian-American Coffee Promotion Committee is formed in New York to promote the sale of Brazil coffee in the United States. It is composed of Frank C. Russell, chairman; Dr. Sebastião Sampaio, vice-chairman; Berent Friele, R. W. McCreery, John M. Hancock, and Felix Coste.
- 1929**—The Huntley Manufacturing Co., Brocton, N. Y., is granted a United States patent on an improved three-roll coffee grinder.
- 1929**—The first coffee is planted in French West Africa.
- 1929**—William A. Rankin, assignor to Roheson-Rochester Corporation, Rochester, N. Y., is granted a United States patent on an improved percolator, and Frederick J. Cross, assignor to the same company, an electric percolator base; William M. Williams, assignor to B. F. Gump Co., Chicago, a coffee granulator; and John N. Shaw, Seattle, an improved coffee urn.
- 1930**—Edward Ahorn, New York, is granted a United States patent on a drip pot; Richard F. Krause, Massillon, Ohio, a drip-coffee maker; Angelo Torrini, Italy, an improved "Express" coffee filter; and Isaac D. Richheimer, New York, improved coffee holder for his "Tricolator" pot.
- 1931**—Bauer Bros., Springfield, Ohio, patent in the United States, a coffee-grinding mill; Isaac D. Richheimer, New York, patents an improved coffee percolator; Richard S. Iglehart, assignor to Bauer Bros., a coffee mill; and Albert W. Meyer, New York, a percolator receptacle for coffee pots.
- 1931**—An International Coffee Congress is held in the city of São Paulo, Brazil. Cooperation in crop control, propaganda, etc., and an international coffee bureau are recommended, but no concrete action results.
- 1931**—The U. S. Stabilization Corporation (Farm Board) barters 25,000,000 bushels of wheat for 1,050,000 bags of Brazil coffee, resulting in many protests against government competition with private business.
- 1931**—Plans are made at the National Association of Coffee Roasters' Convention for a "bigger and better" association to represent every United States coffee interest.
- 1932**—The National Coffee Roasters' Association and the National Coffee Trade Council are succeeded by the Associated Coffee Industries of America, which includes green coffee, chain store, and delivery-route interests, as well as coffee roasters.
- 1932**—The fiftieth anniversary of the New York Coffee and Sugar Exchange is celebrated by a Jubilee dinner at the Waldorf-Astoria and a special issue of the *Tea and Coffee Trade Journal* (March).
- 1932**—A three years advertising contract for Brazil coffee in the United States, with an expenditure of \$1,000,000 annually, is announced as signed by the National Coffee Council, Brazil.
- 1932**—The Huntley Manufacturing Co., Brocton, N. Y., is granted a United States patent on an improved coffee grinder.
- 1932**—Wm. G. Burns and R. A. Greene, assignors to Jabez Burns & Sons, Inc., are granted a United States patent on a stirring cooler for coffee. Also, George C. Herz, assignor to Jabez Burns & Sons, Inc., patents an improved pneumatic separator, for removing stones, etc., from coffee.
- 1932**—Joseph F. Lamb, assignor to Landers, Frary & Clark, secures a United States patent on a self-heating percolator; Richard F. Frause, Massillon, Ohio, a drip-coffee maker; and Eugene G. Berry and Horace G. Woodhead, assignors to B. F. Gump Co., Chicago, a coffee-cutting mill.
- 1933**—The National Coffee Council of Brazil is abolished and the National Coffee Department takes its place. Any plans that may have existed for a Brazil coffee advertising campaign in the United States are dropped.
- 1933**—The Coffee Board of Kenya, East Africa, is formed with headquarters at Nairobi.
- 1933**—Brazil offers a ten per cent bonus in kind to buyers abroad, but this is soon withdrawn due to opposition from the trade.
- 1933**—A Brazilian Mission composed of Captain João Alherito, Mr. Frederico Cox, and Mr. Alfredo Linares visits the United States to arrange for a Brazil coffee exhibit at the Chicago World's Fair, and to discuss possible resumption of Brazil coffee advertising.
- 1933**—Uganda coffee planters organize Uganda Coffee Sales, Ltd., with headquarters in Kampala, for the co-operative marketing of their coffee.
- 1933**—Harry C. Bates, assignor to Corning Glass Works, Corning, N. Y., patents in the United States an all-glass percolator; Joseph F. Quinn, assignor to Geo. W. Caswell & Co., San Francisco, a process for roasting coffee; Kirk E. Potter, assignor to the Buckeye Aluminum Co., Wooster, Ohio, a drip-coffee maker; Joseph F. Lamb, assignor to Landers, Frary & Clark, New Britain, Conn., an electric percolator; Raymond W. Kell and Charles D. Barth, assignors to Macbeth-Evans Glass Co., Charleroi, Pa., a vacuum-type coffee maker; and Arthur D. Nash, assignor to the Libby Glass Manufacturing Co., Toledo, Ohio, a glass coffee pot.
- 1934**—A Code of Fair Competition for the United States coffee industry is approved under the National Recovery Act.
- 1934**—At the invitation of the National Coffee Department, Brazil, a delegation composed of Herbert Delafield, William F. Williamson, Berent Friele, Traver Smith, David E. Fromm, Edward G. Yonker, James M. O'Connor, D. B. Foster, G. M. Skinker, Eugene C. Joannes, George C. Thierbach, George G. Westfeldt, William H. Hickerson, Jr., Roger P. Holman, R. V. McKay, James S. Carson, and William H. Ukers, representing the United States coffee trade, visits Brazil and spends three weeks touring the coffee districts and principal trading cities.
- 1934**—Edward J. Dent, assignor to the American Coffee Corporation, Brooklyn, is granted a United States patent on a method of roasting; Earl M. Evleth, assignor to Bastian Blessing Co., Chicago, a coffee urn; Albert C. Wilcox, assignor to Enterprise Aluminum Co., Massillon, Ohio, an automatic electric drip-coffee maker; Isaac D. Richheimer, New York, a coffee retainer and water spreader; Frank E. Wolcott, assignor to Silex Co., Hartford, a vacuum-type coffee maker; Edward J. Dent, assignor to American Coffee Corporation, New York, a roasting apparatus; Horace G. Woodhead, assignor to B. F. Gump Co., Chicago, a coffee granulator; Geo. D. Macheth, assignor to Macbeth-Evans Glass Co., Pittsburgh, a vacuum-type coffee maker; Frank E. Wolcott, assignor to Silex Co., Hartford, a vacuum-type coffee maker; and Harold K. Wilder, assignor to Kellogg Co., Battle Creek, a process for decaffeinating coffee beans.
- 1935**—J. L. Kopf and Leslie Backer, assignors to Jabez Burns & Sons, Inc., New York, are granted a United States patent on a new method of roasting coffee.
- 1935**—Following the collapse of the NRA, the Associated Coffee Industries of America, Inc., adopts a Code of Fair Practice at its annual convention in Chicago.

---

# A DICTIONARY OF COFFEE

Being a List of Common Names of Various Coffees and a Glossary of Difficult, Dialectal, or Technical Words and Expressions Employed in the Coffee Producing Countries and in the Coffee Trade

---

- about.** The word "about" in a coffee contract in connection with quantity, permits a variation of 5% more or less. It is supposed to be an accidental variation and not one resorted to to take advantage of market conditions.
- Abyssinian** (officially, Ethiopian). Coffee produced mainly in the provinces of Djimmah, Sidamo and Guma in Abyssinia from wild trees. Important quantities are shipped to the United States.
- acidy.** A term used to describe a coffee in which this desirable cup characteristic occurs.
- Aden.** Chief seaport of Arabia. British. One of the principal ports of shipment for Arabian Mocha and Abyssinian coffees.
- Addis Ababa.** The capital of Ethiopia and the chief interior coffee market.
- afloats.** Term applied to coffee on ships en route to port of destination.
- Ahuachapan.** Department of El Salvador which produces coffee.
- Alajuela.** City and province in Costa Rica. Coffees grown in the district are characterized by fine flavor, rich body, and sharp acidity.
- alqueire** (Port.). Old measure of capacity of liquid and dry measure equivalent to 13.8 kilos. An alqueire of coffee cherries weighs 50 kilograms. Also a land measure, 24,000 sq. meters—say equivalent to 6 acres.
- Alta Vera Paz.** Department in the mountains of northern Guatemala, producing a gray-blue bean coffee with a fine mellow flavor, usually called "Coban" coffee after the capital of this Department.
- Amatitlan.** Town on the Pacific slope of Guatemala, the capital of the department of the same name, in which are many coffee plantations.
- Angra dos Reis.** Brazilian coffee port on the bay of the same name 75 miles south of Rio de Janeiro.
- Ankola.** Coffee produced in the district of Ankola, Sumatra, Netherlands Indies. Considered one of the finest coffees grown. It has a heavy body and delicate, rich, musty flavor when aged.
- Antigua.** A district of Guatemala, producing a medium flinty bean, flavory and acid.
- Antioquia.** A Department in Colombia, where "Medellin" coffees are produced.
- Arábigo** (Sp.) Coffee in parchment. Term used in Colombia. There are two official grades, primera and segunda.
- arbitrage.** A transaction wherein the operator takes advantage of either difference in time or means of communication between markets, buying to advantage in one and selling almost simultaneously in the other.
- Armenia.** Market name and town in the Department of Caldas, Colombia.
- arratel** (Port.). Old measure weighing 459 grams.
- arroba.** A measure of weight used in Central and South American countries. The usual equivalent of 12½ kilos, or about 27½ pounds.
- as is.** A term used when selling unsound coffees, meaning that the buyer knows what he is buying and agrees to take it as is.
- bag.** The following are the net weights per bag of coffee shipped from the producing countries: Brazil, 132.27 lbs.; Colombia, 132.27, 137.78, 143.3, and 154.32 lbs.; Arabia, 168 and 176 lbs.; Cuba, 200 lbs.; El Salvador, 150 lbs.; French Colonies on the African Coast, 110.23, 132.27, 143.30, 176.36, 198.41, and 220.46 lbs.; Guatemala, 102 lbs.; Haiti, 176.36; Java and Sumatra, 136 lbs.; Kenya, 183 lbs.; Mexico, 154.32 lbs.; Nicaragua, 150 lbs.; Santo Domingo, 90, 100, 154, 200, and 300 lbs.
- Bahia.** A seaport of Brazil, capital of the state of Bahia, and port of shipment for certain low grades of Brazilian coffee known by this name.
- bale.** A term applied to a Mocba or a Harar coffee package, containing one bale known as a half. A half weighs 80 kilos or 176 pounds net.
- Barahona.** A seaport on the southern coast of Santo Domingo. Coffee grown here is considered the best in the republic. It is noted for its handsome, large beans.
- Barranquilla.** A city and port in Colombia near the mouth of the Magdalena River. It is also connected by rail with the seaport of Puerto Colombia, which has long been a principal export point for Colombian coffee.
- Batavia.** Capital of the Netherlands Indian colony of Java. Principal market for coffee grown in Java.
- beneficio** (Sp.). In the Mexican coffee trade this term means coffee-cleaning establishments including washing, drying, and sorting machinery, as well as sun-drying patios.
- black beans.** Dead coffee beans which have dropped from the trees before harvest. For counting imperfections in grading coffee on the New York Coffee Exchange, the black bean has been taken as the basis unit and all imperfections are calculated in terms of black beans.
- black jack coffee.** This term is applied to coffee which has turned black during the process of curing, or in the hold of a vessel during transportation, or it may be due to a blighting disease.
- Blue Mountain.** A district of the island of Jamaica producing the finest coffee grown on the island. It makes a good appearing roast and pleasantly aromatic cup.
- Boconó.** A town in western Venezuela, giving its name to the coffee grown in that district. Boconós are considered a grade of Maracaibo coffee. They are light in color and body, with a neutral flavor, and are frequently used as fillers in blends.
- Boengie.** A district of the island of Celebes, Netherlands Indies. A small amount of coffee known by this name is produced here. The fine old coffees from this district rank among the leading East India growths.
- Bogota.** Capital of the republic of Colombia, South America. The coffees known by this name are grown in the district around, and prepared in, the city. They are noted for their acidity, body, and flavor.
- Bogota Plantacion.** Coffees grown in the Bogota district of Colombia and prepared on the plantations.
- Bourbon Santos.** Name applied to coffee grown in Brazil, which originally was obtained from Mocha seed. Today Bourbon coffee is distinctly a Brazil plant as no trees or seeds have been brought from the original source for more than 100 years. The Brazil "Bourbon" plant has been developed by grafting "Café Branco" with "Café Murtha" plants, the latter being very much smaller than coffee trees usually seen in Brazil and the berry of which resembles Arabian Mocha. Bourbon Santos is a small curly bean producing a drink that is smooth and palatable. The finest coffee raised in Brazil.
- Boyacá.** A Department in Colombia producing coffee in a small way, commercially.



- braça** (Port.). A measure of length, 2 meters and 2 centimeters.
- Brazil.** The largest republic in South America and the world's largest producer of coffee; Brazil's output, comprising about 70% of the total supply. Coffees grown in Brazil are classified in the trade as "Brazils," to distinguish them from "Milds," and are commercially known by the names of ports. Because Brazil coffees include growths of widely differing characteristics and values, they are better described by the names of their districts of origin.
- brisures** (Fr.). Separated by screening; a special Haiti grade.
- broken.** Coffee beans which have been cracked in the process of curing and cleaning.
- brokers.** There are several classifications of brokers in the coffee trade. *Cost and freight brokers* usually represent the shipper in the country of production and are paid a commission by him, generally on a percentage basis. *First-hand brokers* are known as such because they usually deal in large quantities acting for exporters or importers selling on a cost and freight basis or on landed terms and making their offerings to the larger buyers. This type of broker usually works on a commission of three-quarters of one per cent but when values are low the rate may be increased somewhat. *Spot brokers* work principally with coffees actually on the spot trading with and for local firms. They also buy for out-of-town firms or operate in conjunction with out-of-town brokers. Their commission varies according to the service performed but is usually 15 cents per bag for Rios, 20 cents per bag for Santos, and 25 cents per bag for Milds. *Floor brokers* operate on the floor of the Coffee Exchange buying and selling "futures" at a fixed commission for the account of their principals.
- Bucaramanga.** Market name and town in the Department of Santander, Colombia. Bucaramangas are good commercial coffees for blending purposes. The fancies, when aged, sometimes push the superior East Indian growths hard for first place.
- Buenaventura.** The principal coffee seaport on the western or Pacific coast of Colombia.
- bullhead.** A coffee monstrosity in which the bean has developed to more than double the normal size. This occurs when two beans have grown together. They are interlocked and usually break apart during roasting.
- bundles.** See *bale*.
- buni.** See *Mbuni*.
- c. & f.** Cost and freight. Term applied to any coffee, but usually to coffee bought from Brazilian exporters on which a letter of credit is supplied.
- c. i. f.** Cost, insurance, and freight. Same as c. & f. except that seller absorbs insurance premium.
- café beneficiado** (Port.). Hulled coffee.
- café bonifieur** (Fr.). Term applied in the French West Indies to coffee which has been thoroughly cleaned and polished. So called because the polishing machine is called in Guadeloupe the "bonifieur" (improver).
- café coque** (Fr.). Coffee that is thoroughly dried. Term used in Haiti.
- café de panno** (Port.). Coffee picked in the cloth; i.e., a cotton sheet is spread on the ground under the trees and the coffee does not touch the ground.
- café despulpado** (Port.). Washed coffee or pulped coffee, as this is the process used.
- café em casca** (Port.). Coffee in parchment.
- café em cereja** (Port.). Coffee in the red cherry.
- café em côco** (Port.). Coffee in the dried pod.
- café en parche** (Fr.). Coffee in the parchment. Term used in Guadeloupe.
- café habitant** (Fr.). Term applied in Guadeloupe to coffee which has not been polished.
- café rebeneficiado** (Port.). Coffee re-separated or improved.
- café terreiro** (Port.). Coffee washed and dried in côco.
- cafelate** (Sp.). A local term used in Nicaragua for coffee served with milk.
- cafetal** (Sp.). A plantation of coffee trees.
- caffeine** (C<sub>8</sub>H<sub>10</sub>N<sub>4</sub>O<sub>2</sub>). An alkaloidal substance found in the coffee bean, coffee leaf, tea leaf, yerba maté, cacao bean, etc. Isolated in pure form, it forms long white silky needles. The caffeine content of green coffee averages 1.5 per cent.
- caffeine content.** In a cup of coffee 1.5 grains; of tea, less than one grain.
- caffool.** A volatile aromatic conglomerate formed during the roasting of coffee.
- caffetannic acid.** A term erroneously used to describe the acids of coffee. There is no such definite compound in green coffee nor in roasted coffee.
- Caldas.** A Department in Colombia where "Armenia," "Manizales," and "Caldas" coffees are produced.
- Call.** Market name and town in the Department of Valle del Cauca, Colombia.
- Capitania** (Sp.). Market name for a certain quality of coffee arriving at the port of Victoria, Brazil.
- Caracas.** Capital of Venezuela, South America, a great commercial center, with a population of 150,000. Coffee grown in the neighborhood and shipped through this city is called "Caracas."
- Caracol** (Sp.). A separation of coffee consisting of peaberries selected from firsts and seconds.
- Caracolillo** (Sp.). Name given to peaberry coffee.
- Carangola.** A natural hybrid, found in the district of that name, in Minas Geraes.
- cargo bags.** Bags delivered to the steamer by the shipper and in turn delivered by the steamer to the consignees as differentiated from coffee in bags that may have been supplied by the steamer's agent to replace cargo bags damaged in transit.
- cargo slacks.** Bags of coffee that have become slack through leakage in transit.
- Cartagena.** One of the principal coffee seaports on the north or Atlantic coast of Colombia.
- Cartago.** City and province in Costa Rica. The city is 12 miles east of San Jose. This district produces a high grade of coffee. Also a city in Colombia.
- Cauca.** River and Department in Colombia, where "Cauca" and "Popyan" coffees are produced.
- Ceará.** State in northern Brazil, producing a small quantity of good-quality coffee, about sufficient for home consumption.
- Champerico.** A small seaport on the Pacific coast of Guatemala, from which considerable coffee is shipped.
- Chapada.** Mountain in Matto Grosso, Brazil. General term for a tableland of mountainous country. Certain coffees shipped from Bahia are called "Chapada."
- cherry.** Name applied to the ripe fruit of the coffee tree. The seeds, freed from all coverings, become "green coffee."
- Chiapas.** Coffee-producing district in Mexico, near Guatemalan border. Coffees resemble Guatemalans.
- chicory.** *Cichorium intybus*, a perennial plant, growing to a height of about three feet. The raw root of the plant is cut into slices, kiln dried, and then roasted in the same manner as coffee. It is used as an addition or filler in coffee. Large quantities are grown in Michigan, U. S. A.
- chop.** Before it is shipped from the country of production, each invoice of coffee is made up into a number of divisions called chops, the bags in each division being marked with a particular chop number.
- Chuva.** A mountainous coffee-producing region in the western part of the Department of Quezaltenango, Guatemala.
- city roast.** A term used in New York City, indicating a medium dark roasted coffee, but not as dark as a "full city roast."
- Coatepec.** A coffee-producing district in Vera Cruz, Mexico, about 60 miles from Vera Cruz City. Some authorities regard the finest grades of this coffee as comparing favorably with the best of the world's growths. It is more acid than the west-coast Mexican coffees, has more tang, and an excellent flavor.

**Coatepeque.** Town in Guatemala. Coffee center.

**Cobán.** Capital of the department of Alta Vera Paz in central Guatemala. Coffee known by this name is grown near this town, which is in a mountainous region. It is a waxy, bluish bean, making a handsome uniform roast, spicy and aromatic in the cup, and a particularly good blender.

**coffee.** As defined by the U. S. Department of Agriculture, "Coffee is the seed of cultivated varieties of *Coffea arabica*, *C. liberica*, and *C. robusta*. Green coffee, raw coffee, or unroasted coffee is coffee freed from all but a small portion of its spermoderm, and conforms in variety and in place of production to the name it bears. Roasted coffee is properly cleaned green coffee which by the action of heat (roasting), has become brown and has developed its characteristic aroma.

**coffee fruit.** The outer wrapping is a gossamer-like skin which covers a soft pulp sweetish to the taste, but of a mucilaginous consistency. This pulp in turn encloses the inner seal, called the parchment (because of its tough texture), which covers each seed, or bean, outside the tight-fitting "silver skin," delicately silver-colored and like fine spun silk or the sheerest of paper tissue, which is the final wrapping of the bean.

**coffee grader.** An official licensed by the Coffee Exchange, whose duty it is to grade the coffee according to types recognized by the exchange.

**coffee gradings.** The New York Coffee & Sugar Exchange deals in all coffees grown in North, Central and South America, the West and East Indies, including Washed Robusta, but excluding other Robustas and new or unknown growths. In determining the number of a type, the coffee is graded by the number of imperfections contained in it. These imperfections are black beans, broken beans, shells, immature beans ("quakers"), stones, and pods. For counting the imperfections, the black bean has been taken as the basis unit, and all imperfections, no matter what they may be, are calculated in terms of black beans, according to a scale, which is practically as follows:

#### BLACK BEAN SCALE

3 shells equal .....	1	black bean
5 "quakers" equal .....	1	" "
5 broken beans equal.....	1	" "
1 small pod equals .....	1	" "
1 large pod equals .....	2	" "
1 medium-size stone equals .....	1	" "
2 small stones equal .....	1	" "
1 large stone equals .....	2 to 3	" "

By this scale a coffee containing no imperfections would be classified as type No. 1. The test is made on one-pound samples. If a sample shows six black beans, or equivalent imperfections, it is graded as No. 2; if 13 black beans, as No. 3; if 29 black beans, as No. 4; if 60 black beans, as No. 5; if 110 black beans, as No. 6; and if more than 110 black beans, as No. 7 or No. 8. These two are graded by comparison with recognized exchange types. Coffee grading lower than No. 8 is not admissible to this country.

**coffee insurance.** It is customary for coffee roasters for the trade to carry insurance on all coffee in their buildings waiting to be roasted. The charge for roasting covers cartage, storage, and insurance.

**Colombia.** A republic in the northwestern part of South America which produces some of the finest coffees grown. The best known are those termed "Medelins," "Manizales," "Bogotas," "Bucaramangas," "Tolimas," "Cúcutas," "Girardots," "Hondas," and "Armenias."

**commissario.** Name used in Brazil to designate the commission merchant at coffee ports who bought from the planter, or sold the planters coffee on the commission, stored it in warehouses, and sold it to the exporter. In late years the commissario has practically ceased to be a factor in the coffee business.

**commission merchant.** A person or firm receiving coffee on consignment for sale in a consuming country.

**conto.** A term in Brazil currency equal to 1,000 milreis (1,000,000 reis).

**Coorg.** A district in India producing an inferior growth of lowland-type coffee. The cup is thin and flat.

**Cordilleras.** Spanish term used for the Andes in Colombia, on the slopes of which the best Colombian coffee is grown.

**Córdoba.** A city in the state of Vera Cruz, Mexico, 60 miles from the city of Vera Cruz. Coffees grown in the district of Cordoba take that name. They are too neutral to form the basis of a blend, but can be used to balance the tang of other grades.

**Corinto.** Principal port of Nicaragua on the Pacific Coast.

**Coro.** A small city, capital of the state of Falcon, Venezuela. It is seven miles west of La Vela do Coro, its shipping port. Coffee from this district is of low grade.

**Costa Cuca.** A coffee-growing district in the foothills of the southwestern part of the department of Quezaltenango, Guatemala.

**Costa de Cucho.** A mountainous coffee-growing region in the department of San Marcos, Guatemala.

**Costa Grande.** A coffee-producing district in the foothills of the departments of Retalhuleu and Suchitepequez, Guatemala.

**Costa Rica.** The most southern of the five Central American republics, producing one of the finest coffees in the world. Being of heavy body and sharply acid, they are best adapted for blending. The fancy growths do not usually come to this country, as they are at a premium in Europe—the larger bean coffees especially.

**country damage.** An insurance term meaning damage to coffees occurring in the country of origin after shipment, by contact with wet ground or fresh water.

**Creoule.** A common variety of Brazil coffee.

**Cúcuta.** Market name and town in the Department of Norte de Santander, Colombia. Coffee from this district is largely shipped through Maracaibo, Venezuela, and hence is classed among the Maracaibo types. It ranks with Meridas and fine-grade Boconos. New crop beans are sometimes sharply acid, though they mellow with age and gain in body.

**Cundinamarca.** A Department in Colombia where "Bogota," some of the "Girardot," and some of the "Honda" coffees are produced.

**cup testing.** Judging the merits of a coffee by roasting and brewing some of it to determine whether it has body and if it is smooth, rich, acidic, or mellow; if it is winy, neutral, harsh, or Rioy; if it is musty, groundy, woody, or grassy; if it is rank, bidy, sour, muddy, or bitter. The brew is sipped and held in the mouth only long enough to get the full strength of the flavor. It is then spat out.

**cups of coffee to the pound.** The average, of good strength, is 40 cups.

**date of invoice.** Unless otherwise stipulated, all spot invoices date from the date of purchase, and not from the time of shipment.

**delivered.** The seller undertakes to guarantee safe carriage at his expense to the point stipulated in the contract, and reweigh at destination.

**discounts.** The discounts for cash payment are 2% within 10 days of the invoice date on 100 bags and over, and 1½% within 10 days on less than 100 bags. On spot purchases of Brazils, bought on a 90-day basis, 8% per annum is allowed for anticipation, while on Milds sold on 4 months' basis, 6% per annum is allowed for anticipation.

**Dire-Daoua.** A railway trading center in Ethiopia for Harar and Abyssinian coffees.

**Dominica.** A small British island of the West Indies, producing a very small amount of coffee.

**dry fermenting.** When washed coffee is fermented without water.

**dry roast.** A roasting process in which no water is used to check the roast, the operator depending entirely upon his cooling apparatus.

**en oro (Sp.).** Term used in Guatemala and Mexico for washed coffee when the parchment and silver skin have been removed; also known as "clean coffee."

**en parche (Sp.).** Term used in Guadeloupe for coffee in the parchment.

**Ensacador (Port.).** Brazilian word meaning "coffee bagger."

- Esquintla.** The capital of the department of the same name in Guatemala, the center of a coffee producing section.
- Espírito Santo.** A State in Brazil, the capital of which is Victoria.
- Ethiopian.** See Abyssinian.
- Excelso.** A grade of Colombian coffee consisting of qualities corresponding to "Supremo" and "Extra" types mixed, and may include peaberry of those grades.
- ex dock.** Ex dock contracts require the buyer to take delivery from the pier. Reweighing and a discount for cash should be stipulated in the contract, also an understanding with regard to damaged coffees. Invoices date when coffees are ready for delivery.
- ex ship.** Coffee which is sold before arrival with the understanding that the buyer will remove it immediately after unloading on the dock. Storage charges are to be paid by the buyer.
- Extra.** The second grade of Colombian coffee.
- ex warehouse.** On sales ex warehouse, the seller simply agrees to place the coffees at the disposal of the buyer (store door delivery), all charges thereafter, except weighing, to be for account of the buyer.
- fanegada (Sp.).** About one and three-quarters acres of land. Term used in Venezuela.
- f. a. q.** Fair average quality.
- fazenda (Port.).** A farm; thus, a coffee plantation is a coffee fazenda. Term used in Brazil.
- fazendeiro (Port.).** Proprietor of fazenda.
- fermenting.** A step in the preparation of ripe coffee, which consists of putting the pulped coffee into tanks, with or without water. The process takes hours to days according to altitude and temperature.
- finca (Sp.).** A farm; commonly used for coffee plantation.
- finquero (Sp.).** Proprietor of a coffee plantation. Term mostly used in Central America.
- flat-bean Santos.** A larger bean and without the curly characteristics generally noted in Bourbon Santos. Usually void of acid and rather "flat" taste.
- f. o. b.** Free on board. The seller agrees to place the coffees safely on board the carrier designated by the purchaser. According to a ruling by the Green Coffee Association of New York, f. o. b. New York means f. o. b. only at one of the three coffee terminals approved by the Association. In other words, a seller in New York is not obligated to make f. o. b. deliveries at points other than the approved coffee terminals.
- forwarder.** An agent who takes charge of a coffee shipment for interior clients and directs its transportation from shipping port or warehouse.
- French roast.** This term as applied to roasted coffee means that the bean is roasted high enough to bring the natural oil of the coffee to the surface.
- full city roast.** A term applied to roasted coffee in New York, indicating a roast slightly heavier than a "city roast." The beans are roasted to their full development in "full city roast."
- full difference.** See **Brazil Grading.**
- futures.** The purchase or sale of a coffee contract for delivery in the future. These contracts are dealt in like stocks and bonds, and settlement is made by paying the difference in price, or margin.
- general average.** An insurance term meaning a loss arising from a voluntary and successful sacrifice, or expenses incurred under extraordinary circumstances for the purpose of averting a threatening danger to the common safety. General average losses are contributed to by all the interests at risk and which are benefited by the General Average Act.
- Girardot.** Market name and Magdalena River shipping port, Department of Cundinamarca, Colombia.
- glazing.** Synonymous with coating. Roasted coffees are sometimes glazed or coated to preserve the natural flavor and aroma and to meet the demand of certain classes of trade, principally in the South.
- grade.** A measure of quality agreeing with a standard or varying from it according to certain fixed differences.
- groundy.** An earthy taste sometimes found in damaged coffees. It differs from mustiness.
- Guadeloupe.** An island of the French West Indies; Point-a-Pitre is the chief port and Bass-Terre the capital. Produces a coffee of excellent quality, which is shipped almost entirely to France.
- Guatemala.** Republic in Central America. Produces a stylish coffee, mild or mellow and mostly washed. The mountain-grown coffees make a handsome roast, are of full, heavy body and excellent cup qualities. The lower altitude coffees are light in cup, but flavory.
- hacienda (Sp.).** Farm or ranch. In Venezuela, usually means coffee plantation.
- Haiti.** Republic on the western side of the island of Haiti. Produces only a small amount of coffee, nearly all of which goes to Europe.
- half differences.** See **Brazil grading.**
- Hanahakua.** Coffee-growing district of Hawaii. Produces a good-quality coffee.
- Harar.** City and province in Ethiopia. The coffee of Harar used to be known to the trade as Longberry Mocha or Abyssinian longberry. It is now known as Harar. It is exported through Jibuti or Aden.
- harsh.** A term used to describe a certain coffee flavor. Rio and similarly flavored coffees are generally described as harsh.
- Hemi.** Incorrect for Haimi-Harazi, a district of Yemen Province, Arabia. A quality Mocha coffee.
- Heredia.** City and province in Costa Rica, six miles west of San José. This district produces a high grade of coffee.
- hid coffee.** Coffee that has been overheated during the drying of the berries for the producing of "naturals." Sometimes occurs in washed coffee, but rarely.
- Honda.** Market name and Magdalena River shipping port, Department of Tolima, Colombia.
- Hodeida.** Fortified Turkish seaport on the Red Sea coast of Arabia. An important shipping point for Arabian (Mocha) coffee.
- Honduras.** A republic on the Caribbean Sea coast of Central America, producing a small, sound, bluish-green coffee of fair quality but small quantity.
- Huatusco.** A town in the state of Vera Cruz, Mexico. Coffee from this district is fine appearing and next to Coatepec for acid and blending qualities.
- Huila.** A Department in Colombia where "Neiva" and some "Girardot" coffees are produced.
- hulling.** A last step in the green-coffee preparation process. The operation is done by machines, which remove the parchment and "silver skin."
- husking.** Cleaning coffee beans that have been dried in the cherry. Coffee is said to be "in the husk" when the whole fruit is dried without water treatment.
- Ibagué.** Market name and town in the Department of Tolima, Colombia.
- imperfections.** Coffee is graded by the number of imperfections in the sample. These are black beans, broken beans, shells, immature beans ("quakers"), stones, and pods.
- importer.** A person or firm that buys for shipment from the producing country and resells the invoice as shipped, in any position, as a whole or in divided quantities without selection of specified chops.
- in store.** In store contracts require the seller to store the coffees, clean them and make them ready for delivery. Buyer should receive the benefit of free storage, fire insurance and weighing privileges as previously determined. Invoices date when 90% of the coffees are in store and ready for delivery. Only sound and made sound coffees are deliverable. According to a ruling of the Green Coffee Association of New York, "In Store" means stored at one of the three approved coffee terminals.
- invisible supply.** The unknown stocks of coffee, including those held by roasters, retailers, etc.
- invoice.** One or more chops of coffee billed together at one time as one sale.

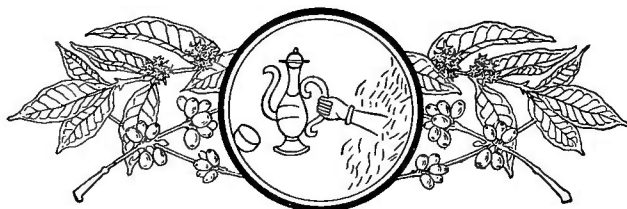
- Italian roast.** Term applied to coffee which has been roasted darker than French roast. Much used by Italians, as well as in many of the coffee-producing countries.
- Jalapa.** A city and district in Mexico adjoining the celebrated Coatepec district and producing some fine coffee known as Jalapa. A stylish roaster; rather neutral cup.
- Jamaica.** Largest of the British West Indies; Kingston, capital and shipping port. Produces two distinct types of coffee, the highland and the lowland. Among the the highland is the celebrated Blue Mountain coffee (q. v.). The lowland coffee is a poorer grade and is used chiefly as a filler in blends and for French roasts.
- Java.** An island of the Netherlands Indies; principal ports are Batavia, Semarang, and Sourabaya. Only coffees of the *Coffea arabica* variety grown upon this island can be labeled "Java" in the United States. Java coffee was originally of the *Coffea arabica* variety, but now the Liberian and Rohusta varieties are also grown on the island.
- Jibuti.** The chief port and capital of French Somaliland, through which Abyssinian coffees are shipped to Europe and America. Sometimes spelled Djibouti.
- Jinotega.** City and Department in northwestern Nicaragua. A small quantity of coffee is raised in this Department, most of which goes to Europe.
- kafa.** Wild Abyssinian coffee (q. v. "Abyssinian").
- Kenya.** A colony in British East Africa, producing a high-grade of the *arabica* variety known as Kenya coffee.
- kilogram.** 2.2046 pounds.
- kilometro (Port.).** 1,000 meters or 0.62 mile.
- Kona.** A district on the west side of the island of Hawaii. Produces the best of Hawaiian coffee. It has a large, blue, flinty bean, is mildly acid with striking character.
- La Guaira.** A seaport of the federal district of Caracas, Venezuela. All Caracas coffee is shipped from this town.
- La Libertad.** Department and seaport of El Salvador. The department produces some coffee.
- last bag notice.** When approximately 90% of a coffee cargo has been unloaded and stored, the warehouse issues what has become known as the "last bag notice." In the majority of cases the coffee has been sold before arrival and, on receipt of the notice, the importer can transfer ownership of the coffee to save interest.
- La Union.** City and Department of El Salvador. The Department produces some coffee.
- leather.** Particles of the outer skin of the coffee cherry which have a red, leathery appearance.
- Libano.** Market name and town in the department of Tolima, Colombia.
- Liberian.** *Coffea liberica*, the coffee species which originated in Liberia, Africa. It was formerly mixed with Bourbon Santos to some extent, but is generally considered low grade, although it makes a handsome, elephantine roast.
- Longberry Harar.** A grade of coffee produced in Ethiopia (Abyssinia). Harar coffees are separated into three grades: 1. All large beans. 2. Shortherry (all small beans). 3. Longberry, which is between grades 1 and 2.
- Macassar.** A seaport on the island of Celebes, Netherlands Indies, through which coffee is shipped.
- machiné épilerré (Fr.).** Machine stoned; i. e., simple preparation by machine. Term used in Haiti.
- made sound.** Coffee that was damaged but which has been cleaned and made merchantable.
- Madras.** A seaport and district (Madras presidency) in southern India, whence come Malabar coffees.
- Magdalena.** The principal river in Colombia. Also a department of Colombia, where "Santa Marta" coffee is produced.
- Malabar.** Name given to the best of India coffees; small, blue-green bean, with strong flavor and deep color in the cup.
- Mandheling.** Coffee produced in Mandheling district on Sumatra's west coast. It is one of the finest and highest-priced coffees in the world.
- Mangalore.** A seaport on the west coast of southern India, through which a large proportion of Indian coffee is exported.
- Manizales.** Market name and town in the department of Caldas, Colombia. Manizales coffees are similar to Medellins in cup qualities, but not so heavy-bodied nor flavory.
- manzana (Sp.).** A parcel of land equal to 1.72 acres.
- Maracaibo.** A port on Lake Maracaiho, Venezuela. An important shipping port for Merida, Tachira, Tovar, Trujillo, and Cúcuta coffees. The last-named coffee is grown in Colombia.
- Maragogipe.** A variety of *Coffea arabica*, first discovered growing near the town of Maragogipe, Bahia, Brazil, where it is called *Coffea indigena*. It is a well defined variety, with light-green leaves having colored edges; berries large, broad, and sometimes narrower in the middle; a light bearer.
- mat.** All Java coffee is exported in fiber hags or "mats" weighing one-half picul (about 67 lbs.). Two "mats" are usually packed in one bag.
- Matagalpa.** A coffee-growing district of Nicaragua. The coffee has a large, handsome, blue, washed bean, making a fancy roast with plenty of acid in the cup.
- Mattari.** A coffee-growing district of Arabia, producing one of the superior grades of Mocha coffee.
- mazagran (Fr.).** The French name for a drink composed of cold coffee and seltzer water.
- Mbuni.** East African coffee berries from which neither the pulp nor the hulls have been removed.
- Medellin.** Capital city of the Department of Antioquia, Colombia. Name given to one of the finest growths of Colombian coffee. Medellins are fancy mountain-grown coffees and are esteemed for their good qualities. They are light to dark green, handsome roasters, with fine flavor and body.
- Menado.** A seaport and district on the island of Celebes, Netherlands Indies. Coffee from this district is of superior quality and commands a high price in Europe.
- Mérida.** District of Venezuela. Gives its name to one of the best of Maracaibo coffees. Meridas are sought for their peculiarly delicate flavor; is neither acidy nor bitter.
- metro (Port.).** Equivalent to 39.37 inches.
- Mexico.** A republic between the United States and Central America, producing some of the most important blending coffees. Well-known types are Oaxaca, Córdoba, Coatepec, Jalapa, Pluma Oaxaca, and Tapachulas. In general Mexicans are mild or mellow. The green beans are greenish to yellow (when aged) and of large size. The washed coffees make a handsome roast, showing pronounced central stripe. In the cup they have a full, rich body, fine acidity, and a wonderful bouquet.
- mild coffees.** Coffees produced mainly in countries other than Brazil. A term used to indicate coffees that are free from the harsh Rio flavor.
- milreis.** Unit of Brazil currency, written 1\$000. Par value of gold milreis is about 54.6 cents; paper milreis, 11.96 cents.
- Minas Geraes.** State in Brazil. Produces a Rio coffee of peculiar flavor and aroma.
- Mocha.** Former important coffee port on the Red Sea coast of Arabia. Closed by sand bar over 100 years ago. Only coffees grown in Arabia are entitled to the trade name Mocha. They are now shipped through the ports of Hodeida and Aden. Small, irregular beans, in color olive green, shading off to pale yellow. The roast is poor and irregular. In the cup they have a unique acid character, heavy body; in flavor, smooth and delicious.
- Murtha (*Coffea myrtifolia*).** A Santos coffee said to provide the finest and smoothest cup in this variety.
- musty.** A flavor often found in coffee as a result of either overheating or aging. Mustiness from overheating is undesirable, while the must of age is very desirable.
- Mysore.** A native state of southern India which produces a mountain-grown coffee mostly marketed in England.

- Nariño.** A coffee-producing department of Colombia.
- native cherry.** A term used in India to describe the coffee fruit, which is dried in the cherry. Then it is hulled by hand.
- Nicaragua.** Central American republic, producing a relatively small amount of coffee. In general, the washed coffees have merit, but the naturals, comprising the bulk of the crop, are of ordinary quality, and frequently Rioy.
- no arrival, no sale.** This clause is intended to relieve a seller from the obligation of filling a contract when it can be shown that he actually made the shipment but that it was lost in transit.
- Norte de Santander.** A department in Colombia where "Cúcuta" and "Ocaña" coffees are produced.
- notice.** Announcement of final delivery on a previously made "future" contract; used in coffee trading on the N. Y. Coffee Exchange.
- Oaxaca.** Capital of the state of Oaxaca, Mexico. Oaxaca coffee is valued because of its sharp acidity and excellent flavor. The bean of the Sierra Oaxaca (common unwashed) is not large, nor is the appearance stylish. The Pluma Oaxaca (washed) coffee is a fancy bean and good for blending purposes.
- Ocaña.** Market name and town in the department of Norte de Santander, Colombia.
- Ocos.** A small coffee port on the Pacific Coast of Guatemala, near the Mexican border.
- Old Government Java.** A name formerly applied to coffee grown on native estates in Java and Sumatra and stored by the Dutch government.
- Orizaba.** The capital of the state of Vera Cruz, Mexico. Gives its name to coffee grown in the surrounding district. This coffee has good cup quality and ranks next to Huatusco.
- Padang.** Principal shipping port on the West Coast of the island of Sumatra. Only Ankola and Mandheling coffees are shipped through this port.
- Palembang.** A district and shipping port on the southeast coast of Sumatra. Robusta coffees only are shipped through this port.
- palmo** (Port.). A hand—approximately 8.64 inches.
- parchment.** The endocarp of the coffee fruit. It lies between the fleshy part or pericarp and the silver skin, and is removed during the hulling process. Coffee is said to be "in the parchment" when dried after the outer skin and pulp have been removed by water treatment.
- particular average.** An insurance term meaning a partial loss or damage to ship, cargo or freight, or any of them resulting directly from the perils of the voyage and which are purely accidental in nature. Under particular average, the losses are not contributed to by the other interests but are borne by that interest which has sustained the damage.
- Pasilla.** A Colombian coffee of low grade; also hand pickings.
- patio** (Sp.). A cement-covered courtyard where green coffee is sun-dried.
- Peaberry.** A rounded bean from an occasional coffee cherry which contains but one seed instead of the usual flat-sided pair. This is due to non-development of one of the ovules—an abortion most common in "Arabica" coffees. These round beans were formerly called *gragé* coffee, but now are more commonly known as peaberry, or male berry. It is the same in cup quality as the flat bean, but frequently commands a slightly higher price.
- pergamino** (Sp.). Parchment (q. v.). Pergamino coffee is coffee that has been dried after pulping, fermenting, and washing.
- pilé** (Fr.). Coffee dried and hulled by dry process. Term used in Haiti.
- plantation coffee.** A term used in India for pergamino, or parchment, coffee.
- points.** A term used by coffee graders to indicate difference in grades. The term is also used by Coffee Exchange operators to indicate fluctuations in prices, 100 points constituting one cent.
- Popayan.** Market name and town in the Department of Cauca, Colombia.
- Preanger.** A district on the island of Java, producing the best of the Java growths of coffee.
- primary market.** The market in the country of production.
- Private Estate.** For many years the Dutch government controlled four-fifths of the area under coffee in the Netherlands Indies. The small area, known as private estates, then controlled by private enterprise, gradually expanded, until the government withdrew from the coffee business in Java in 1905, and in Sumatra in 1908, and withdrew from all coffee cultivation in 1918-19.
- Puerto Barrios.** Guatemala's largest port and most important coffee-exporting town. It is on the Caribbean Sea coast.
- Puerto Berrío.** A town on the Magdalena River, Colombia. Almost all Medellín coffee is shipped through this port.
- Puerto Cabello.** A seaport town of Venezuela. Coffees known by this name are grown at a low altitude and are inferior in flavor to Caracas coffees.
- Puerto Colombia.** A seaport on the North coast of Colombia.
- Puerto Cortés.** A coffee port on the Caribbean Sea side of Honduras.
- Puerto Limón.** The Atlantic port of entry of the republic of Costa Rica; important for exports of Costa Rican coffee.
- Puerto Rico.** An island in the West Indies. The superior grades of Puerto Rican coffees rank among the best growths known to the trade. They have a large, handsome, washed bean and make a fancy roast without quakers. The cup has a peculiar flavor similar to a washed Caracas, but smoother.
- pulping.** The first step after picking in the preparation of coffee by the wet method. It consists in removing by machinery the outer skin. The machines rub away the pulp by friction without crushing the beans.
- Puntarenas.** The Pacific port of entry of the republic of Costa Rica, from which coffee is exported.
- quakers.** Term applied to blighted and undeveloped coffee beans. Quakers affect the cup quality and are detrimental to style. Quakers are fewer in washed coffees.
- quintal.** 220.46 pounds avoirdupois.
- rat-eaten.** Bags attacked by rats while in the hold of the vessel or in the warehouse. According to trade custom, the steamship's agent or the warehouseman must furnish new bags.
- reis.** Plural of *reil*, Brazilian money; one thousandth of a milreis.
- Ribeirão Preto.** Town and coffee district in the State of São Paulo, Brazil. Produces a fine quality of genuine Franca Bourbons.
- Rio de Janeiro.** The capital of Brazil and its most important city. Population 1,720,800; 4,748 miles from New York. Coffees shipped through this port are known as Rios. Rio coffee is not generally liked in the United States. It has a peculiar, rank flavor with a heavy pungent and harsh taste which traders do not consider of value either in straight coffee or in blends. However, its low price causes it to be found in the cheapest brands of package coffees. In color, the bean runs from light green to dark green, but when it is stored for any length of time the color changes to a golden yellow and the coffee is then known as "golden Rio."
- Rio flavor.** A heavy and harsh taste characteristic of coffees grown in the Rio district of Brazil, and sometimes present even in fancy mild coffees.
- Robusta.** *Coffea laurentii*, or Robusta coffee, is a species discovered growing wild in the Congo by Emil Laurent in 1898. A Brussels horticultural firm that took it up commercially designated it Robusta. The plant is much larger than either the *arabica* or the *liberica*. The tree is a very hardy variety, and for this reason has been cultivated rather extensively of late years, particularly in the Netherlands Indies. The United States Bureau of Chemistry ruled in February,



- 1921, that *Coffea robusta* could not be sold as Java coffee, or under any form of labeling which tended either directly or indirectly to create the impression that it was *Coffea arabica* so long and favorably known as Java coffee. This was in line with the Department of Agriculture's previous definition that coffee was the seed of the *Coffea arabica* or *Coffea liberica* and that Java coffee was *Coffea arabica* from Java. Robusta formerly was barred from deliveries on the New York Coffee Exchange, but washed Robustas are now accepted on Contract "A."
- rubbery coffee.** Term usually applied to the taste of Robustas.
- Rubiaceae.** The botanical family to which coffee belongs.
- Salvador (El).** A Central American republic producing a large-bean, fair-roasting coffee. The bulk of the crop is washed. Those grown at low altitudes are of very thin body but the high-grown are of full body and good quality. The largest part of the production goes to Europe.
- Sanani.** Mocha coffee from the Sana region of Arabia. One of the better-grade Mochas; little used in the United States.
- San José.** The most important port on the Pacific Coast of Guatemala, shipping large quantities of coffee.
- San Marcos.** Department in the northwestern part of the Republic of Guatemala, bordering on Mexico. Many large plantations are located here.
- San Pedro.** An important coffee market in Honduras.
- Santa Ana.** A Department in El Salvador producing about a sixth of that country's coffee. The capital is the city of the same name.
- Santa Marta.** Market name and Atlantic port in the Department of Magdalena, Colombia.
- Santander.** A Department in Colombia where "Bucaramanga" coffee is produced.
- Santo Domingo.** Capital of the republic of Santo Domingo (Dominican Republic) on the island of Haiti, West Indies. Coffee produced here is sometimes carelessly prepared. The bean is blue-green and makes a handsome roast. When properly grown and cured, the coffee ranks well, having a rich, fairly acid flavor in the cup.
- Santos.** The principal shipping port for coffee in Brazil. It is 200 miles southwest of Rio de Janeiro and 49 miles from São Paulo. The city gives its name to the coffees which pass through it. Santos coffees, considered as a whole, have the distinction of being the best grown in Brazil. The bulk of the Santos coffees are hull-dried on open terraces, as the "dry" method has been found best for handling large volume of crop. Pulped, or "washed," coffees have increased in recent years, in this market, and are accorded preferential entry rights.
- São Paulo.** The capital city of the state of the same name in Brazil. The State of São Paulo is the world's largest and richest coffee area, producing about 50 per cent of all supplies.
- Segunda.** A grade of Colombian coffee consisting of small but sound beans, and may have a mixture of peaberries.
- Semarang.** A seaport town on the north coast of the island of Java. Coffee known by this name is a small, yellowish green bean and is light and thin in cup quality.
- Sevilla.** Market name and town in the Department of Valle del Cauca, Colombia.
- ship fillings.** The coffees swept from the hold of the vessel and from the pier. According to trade custom, the steamship's agent must clean and bag these before delivery.
- ship samples.** Samples of coffee forwarded from port of shipment, representing cargo shipped. They usually precede actual shipment, coming by fast steamer before shipment is made.
- ship sweepings.** Coffee spilled into the hold of the ship, owing to faulty bags and rough handling, is swept up and delivered with the sound product, averaging about one bag of sweepings to 1,000 bags. These sweepings are often made up of splinters, large pieces of stone, coal, cacao beans, corn, and other products. Ship sweepings usually are marked plainly to prevent their becoming mixed with sound coffee.
- shipper's slacks.** These are bags of coffee originally delivered by the shipper to the steamer in a slack filled condition. The steamship company is not required to furnish ship fillings offsetting the slack weight. They should, however, note them as slacks on the bills of lading, which they usually do not.
- Shortberry Harar.** A shorter bean coffee than the Longberry Harar (q. v.).
- Sibolga.** Coffee shipping port on the west coast of Sumatra. Ankola coffees principally are shipped from this port.
- Sierra.** Market name for a Mexican coffee of inferior quality.
- silver skin.** The thin, papery covering on the coffee bean surface, inside the parchment.
- sizing.** Grading the green coffee bean by sizes. Done usually by machines that automatically separate and distribute the different beans according to size and form. The principal grades are triage, third flats, second flats, first flats, and first and second peaberries.
- skimmings.** That part of a bag of coffee which has been damaged in shipment by contact with moisture. The damaged portion is "skimmed off" and classified according to the extent of the damage as good skimmings (G. S.), medium skimmings (M. S.), and poor skimmings (P. S.).
- slacks and bad order bags.** Bags of coffee that have become torn in transit and part of their contents spilled.
- Sobras.** A non-exportable grade of Colombian coffee, consisting of waste or residues of coffee.
- Socorro.** A large coffee district in the Mexican state of Chiapas, near the Guatemalan border.
- sound coffee.** Coffee in merchantable condition.
- source.** The place of origin, sometimes understood as a seacoast port of the country of origin. On Colombian coffee it means the place of origin in the interior.
- spot.** Green coffee buyers in the large importing centers recognize two distinct markets in their operations. One of these is called the "spot" market, because the importers, brokers, jobbers, and roasters trading there deal in actual coffee in warehouses in consuming countries. The other market is designated as the "futures" or "shipment" market. The trading here is concerned with the purchase or sale of contracts for future delivery of coffee that may still be on the trees in the producing country. Futures, or "options," as they are frequently called, are dealt in only on a coffee exchange.
- standard.** Quality arbitrarily fixed by some recognized authority such as the Coffee Exchange, or the Green Coffee Association.
- steamer sweat.** An insurance term meaning damage to coffee from sweat generated by the heat in the hold of a vessel.
- steel cut.** Generally understood to mean that in the grinding process the chaff has been removed and an approximate uniformity of granules has been obtained by sifting. The term does not necessarily mean that the grinding mills have steel burrs.
- style.** A trade term used to designate the appearance of a whole coffee bean, either green or roasted.
- Sucre.** The state in northeastern Venezuela in which is the port of Cumana. Puerto Sucre is the port for the city of Cariaco.
- Sumatra.** An island of the Netherlands Indies. Included among the coffees of Sumatra are several that are conceded to be the finest the world produces.
- summer roast.** The summer heat causes coffee to sweat; so roasters frequently give the bean a lighter roast in summer than in winter to prevent sweating.
- Supremo.** The first or top grade of Colombian coffee.
- Surinam.** Another name for Dutch Guiana. Only a small quantity of coffee is grown here and the trade is insignificant.
- sweated coffee.** Green coffee that has been submitted to a steaming process to give the beans the extra-brown appearance. Artificial "sweating" is illegal and classified as adulteration and misbranding under the Pure Food & Drugs Act of 1906.
- sweet.** A trade term to describe coffee which is free from harshness or Rio flavor or any form of damage.

- Tabasco.** A small, coffee-producing state in Mexico on the Gulf of Mexico.
- Tachira.** A coffee-producing state in western Venezuela. Until recent years, Tachira coffee always was sold as Cúcuta (from the name of the town in Colombia through which it was shipped to Maracaibo). Now it is shipped under the name Tachira-Venezuela, while Cúcuta is marked Cúcuta-Colombia.
- Tampico.** A port on the east coast of Mexico giving its name to an inferior grade of coffee.
- tannin.** The same as tannic acid. A solid, uncrystallizable, yellowish white, astringent compound. The tannin content of green coffee averages 8 per cent. Roasting reduces this about 50 per cent (Chem.,  $C_{14}H_{10}O_2$ ).
- tare.** The weight of the bag in which the coffee is packed. On Santos coffee, the tare is 1 lb. 2 oz. On Rios it is 1 lb. On Milds it is actual weight.
- Tegal.** Port on the north coast of Java, from which a high-grade coffee of the same name is shipped.
- Tellicherry.** A port on the west coast of southern India, ranking next to Mangalore as a coffee port. The district of Tellicherry produces a good grade of coffee.
- tel quel.** Same as "as is."
- Telok-Betong.** Coffee shipping port on the southeast coast of Sumatra. Robusta coffees from the district of Lampong are shipped through this port.
- Tercera.** A grade of Colombian coffee with crumpled, shriveled, or white beans, but no black beans; contains a percentage of perfect, but small beans.
- terreiro** (Port.). Drying grounds.
- Timor.** The principal island of the Timor Archipelago, east of the Sunda Islands and north of Australia, producing a comparatively small quantity of good quality coffee known by this name.
- tipping.** Charring the little germ at the end of the coffee bean during the roasting process, by too quickly applying an intense heat.
- to arrive.** Term applied to coffee which is purchased when awaiting shipment from the producing country or when in transit.
- Tolima.** A Department in Colombia where "Tolima," "Ibague," "Libano," some of the "Girardot," and some of the "Honda" coffees are produced.
- Tovar.** A town in Venezuela. Coffee known by this name has fair to good body without acidity and makes a duller roast than Cucutas. It is used for blending with Bourbon Santos.
- traviesa** (Sp.). Secondary crop. Term used in Colombia.
- Tres Rios.** A village and important district in Costa Rica, producing some of the finest coffee grown. The village is some six miles from San José.
- triage** (Fr. for grading or separating). Used by the coffee trade of southern India to describe broken coffee beans. The word has come to be used in most coffee countries as one of the six usual coffee separations.
- trié** (Fr.). Perfectly clean coffee. Term used in Haiti.
- Trujillo.** Capital of the Venezuelan state of the same name. Trujillo coffees lack acidity and make a dull rough roast unless aged. They are blended with Bourbon Santos to make a low-priced palatable coffee.
- Tumbador.** A coffee district in the Department of San Marcos, in the mountainous region of Guatemala, producing a fine grade of coffee.
- Turkish-style coffee.** A trade term for a flour-like grind.
- type.** A sample fairly representing the coffees under trade, but not necessarily a portion of the lot to be delivered.
- Uganda.** A British protectorate in East Africa producing a coffee which is generally known as Uganda and shipped almost entirely to Great Britain.
- unwashed coffee.** Green coffee as produced by the dry process; *viz.*, drying the entire fruit and then, by hulling operations, removing the skin, pulp, parchment, and "silver skin."
- Uruapan.** A city in the state of Michoacan, Mexico, situated in a valley which produces a famous coffee although not in commercial quantities.
- usual good quality.** Means usual good quality of the season, but frequently is left to arbitrators.
- Usulután.** A leading coffee-producing department of Salvador.
- Valle del Cauca.** A Department in Colombia where "Valle," "Cali," and "Sevilla" coffees are produced.
- Valorization.** From the Portuguese *valorização*, giving value to. Since 1908 valorization of coffee has been practiced in Brazil. Permanent valorization was adopted in 1922. In 1931 the Federal Government began purchasing surplus coffee stocks, taxing new plantings, and destroying the low grade coffees acquired from a tax in kind.
- Victoria.** A coffee port in the state of Espírito Santo, Brazil. Victorias rank third among Brazil coffees. They are a large, dingy-green or brown bean making a roast free from quakers, but muddy in the cup.
- visible supply.** The known coffee stocks in public warehouses, afloat, and at ports of shipment.
- washed coffee.** Coffee which has been pulped, fermented, washed, dried, and bulled. The ripe fruit is passed through a "pulper" which takes off the outer skin. Fermentation and washing remove the gummy substance. Drying, hulling, and separating complete the preparation process.
- woody coffee.** Green coffee which has deteriorated and lost its commercial value.
- Yemen.** A district in Arabia along the Red Sea, which produces a superior grade of Mocha coffee.



# A COFFEE BIBLIOGRAPHY

A Selected List of Historical Writings, Notable Books, and Periodical References Gathered from the Principal General and Scientific Libraries—  
Arranged in Alphabetic Order of Topics

## TOPICS AND SUBDIVISIONS

ADULTERATION	DISEASES AND ENEMIES	PHYSIOLOGICAL EFFECTS ( <i>Continued</i> )
BOARD OF HEALTH REGULATIONS	GENERAL WORKS	OF DIFFERENT CONSTITUENTS
BOTANICAL DESCRIPTION	LITERATURE, POETRY, ROMANCE	OF GREEN COFFEE
CHEMISTRY	MANUFACTURING PROCESSES	OF LEAVES OF COFFEE TREE
ANALYSIS, GENERAL	BREWING	OF ROASTED COFFEE
CAFFEINE	GLAZING	OF SMOKING COFFEE
CAFFEINE-FREE COFFEE	MISCELLANEOUS	ON CHILDREN
CAFFEOL	MODIFICATIONS	ON DIFFERENT ORGANS AND SYSTEMS
GREEN COFFEE	POLISHING AND COLORING	SUBSTITUTES
ROASTED COFFEE	ROASTING AND GRINDING	GENERAL
CHICORY	MEDICINAL QUALITIES AND USES	MALT COFFEE
CHICORY IN COFFEE	ANTISEPTIC AND DISINFECTANT	TAXATION, JURISPRUDENCE, ETC.
COFFEE HOUSES	GENERAL	TRADE AND STATISTICS
CULTURE AND PREPARATION	PHYSIOLOGICAL EFFECTS	EXCHANGE TABLES
GENERAL	GENERAL USE AND MISUSE	GENERAL
REGIONAL	OF CAFFEINE-FREE COFFEE	REGIONAL
SOILS	OF CHEWING COFFEE	VALORIZATION

## ADULTERATION

- ADULTERATION of coffee. Report of the proceedings of a public meeting held at the London Tavern, March 10, 1851. *London*, 1851.
- DAFERT, FRANZ W. Las sustancias minerales del cafeto. *San José*, 1896. 33 pp. *Also*, *Anales del Instituto médico nacional*, 1897, III:25, 41, 62, 78.
- GRAHAM, T., and others. Chemical report on the mode of detecting vegetable substances mixed with coffee for purposes of adulteration. *London*, 1852. 22 pp. (Board of Inland Revenue).
- LES FRAUDES du café dévoilées par un amateur. *Paris*.
- SIMMONDS, P. L. Coffee as it is and as it ought to be. *London*, 1850.
- Periodicals*
- BERTARELLI, E. Su una sofisticazione del caffè torrefatto mediante aggiunta di acqua e borace. *Giornale di Farmacia*, 1900, 338-343. *Also*, *Rivista d'Igiene e Sanità pubblica*, 1900, XI:467-472.
- BUNCE, EDWIN H. and MOITRA, G. C. The detection of adulteration of Indian coffee, with special reference to the extract method. *The Analyst*, Nov. 1932:708.
- CABALLERO, F. G. Inconvenientes del uso del café puro y del que se toma con leche; sofisticacion de los componentes de esta bebida, etc. *Boletin de Medicina y Cirugia*, 1851, 2 ser. I:177-185.
- CASAÑA, J. Acerca del producto llamado legumina y sofisticaciones del café. *Anales de la real Academia de Medicina*, 1905, XXX:359-364.
- CHIAPPELLA, A. R. Il caffè macinato che si consuma in Firenze — Alcune sofisticazioni non ancora descritte. *Annali d'Igiene sperimentale*, 1904, n. s. XIC:427-448.
- Le sofisticazioni del caffè che si consuma in Firenze, *Società toscana d'Igiene*, 1905, n. s. V: 110-116.
- CHEVALLIER, J. B. Café indigène. *Annales d'Hygiène*, 1853, XLIX:408-412.
- COFFEE and its adulterations. *Lancet*, 1851, I:21, 465; 1853, I:390, 477; 1857, I:195. *Also*, *Pharmaceutical Journal*, 10:394-396.
- COLLIN, E. Del caffè e sue falsificazioni. *Giornale di Farmacia, di Chimica e di Scienze affini*, 1879, XXVIII:529-535; 1880, XXIX:20-22.
- CORIEL, F. Analyse d'un café artificiel torréfié. *Journal de Pharmacie et de Chimie*, 1897, 6. ser. VI:106-108.
- CRIBB, C. H. Note on (1) samples of coffee containing added starch; (2) a sample of artificial coffee berries. *Analyst*, 1902, XXVII:114-116.
- CROMBIE, S. Examination of ground coffee as found in shops. *Physician and Surgeon, Ann Arbor*, 1882, IV:401.
- DOOLITTLE, R. E. Coffee sophistications. *Tea and Coffee Trade Journal*, 1912, XXIII:Supplement to no. 6, 62-65.
- DRAPEE, J. C. Coffee and its adulterations. *New York Academy of Medicine. Bulletin*, 1869, III: 210-218.

- DUBBISAY. Falsifications des cafés, procédés employés à cet effet; moyens de reconnaître et de reprimer la fraude. Recueil des travaux du Comité consultatif d'Hygiène publique de France, 1888, XVIII:19-33.
- DUCROS, H. A. De quelques falsifications du café Moka. Institute égypt. Bulletin, 1901, 4. ser. pp. 293-306.
- EDSON, C. Report on Colored imitation Java coffee. Sanitary Engineer, 1883-4, IX:614.
- ESTUDIO del cafeto. Anales del Instituto médico nacional, 1897, III:139-144.
- FALSIFICATION du café. Annales d'Hygiène, 1864, 2. ser. XXII:437-443.
- FRICKE, E. Neuere Kaffeeverfälschung. Zeitschrift für Medizinalbeamte, 1889, II:178.
- GIRARDIN, J. Rapports sur un café avarié par l'eau de mer et sur poudre destinée à remplacer le café. Annales d'Hygiène, 1834, XI:87-103.
- GRIEBEL, C. and BERGMANN, E. Ueber eine neue Kaffeeverfälschung. Zeitschrift für Untersuchung der Nahrungs- und Genussmittel, 1911, XXI:481-484.
- HARNACK, E. Ueber die besonderen Eigenarten des Kaffegetränkes und das Thurmsche Verfahren zur Kaffeereinigung und verbesserung. Münchener medizinische Wochenschrift, 1911, LVIII:1868-1872.
- HARRIS, WILLIAM B. Green and roast coffees, the adulteration and misbranding thereof. American Grocer, 1913, Nov. 19, pp. 19-20.
- HESSE, P. Ueber eine Kaffeefarbe. Zeitschrift für Untersuchung der Nahrungs- und Genussmittel, 1911, XXI:220.
- JAMMES, L. Le café torréfié, en grains, factice. Revue d'Hygiène, 1890, XII:1044-1050.
- MOCHA coffee. Scientific American, 1903, LXXXIX:81.
- MUNTA, V. Apuntes acerca de las adulteraciones del café y medios para reconocerlas. La Gaceta de Sanidad militar, 1883, IX:286, 394.
- NOTTBOHM, F. E. and KOCH, E. Arsenhaltige Kaffeeglasierungsmittel. Zeitschrift für Untersuchung der Nahrungs- und Genussmittel, 1911, XXI:288-290.
- OTTOLENGHI, D. Sopra una frequente sofisticazione del caffè in polvere. Atti della reale Accademia dei Fisiocritici di Siena, 1903, 4. ser. XV:381-389.
- PARECER do comissão encarregada pela Sociedade pharmaceutica lusitana de investigar se uma determinada especie de café é prejudicial á saude 185. Also, Correio medica de Lisboa, 1874, III:136, 147.
- RAUMER, E. VON. Beobachtungen über Kaffeeglasuren seit dem Inkrafttreten der Kaffeesteuer. Zeitschrift für Untersuchung der Nahrungs- und Genussmittel, 1911, XXI:102-109.
- REISS, F. Ueber eine mechanische Verfälschung der Kaffeesahne. Zeitschrift für Untersuchung der Nahrungs- und Genussmittel, 1906, XI:391-393.
- SOCIANTI, L. Caffè adulterato con sostanze nocive. Rivista d'Igiene e Sanità pubblica, 1895, VI:497-499.
- SORMANI. Di un nuova falsificazione del caffè. Giornale della reale Società Italiana d'Igiene, 1882, IV:401.
- SPENCER, G. L. and EWELL, E. E. Tea, coffee, and cocoa preparations. U. S. Dept. of Agriculture. Division of Chemistry. Bulletin, XIII, pt. 7.
- VARIOUS "coffees." Lancet, 1915, II: 1006.
- VOGEL VON FERHELM, A. Zur Frage der Zulässigkeit der Verwendung der sogenannten tauben oder Strohfeigen bei der Feigen Kaffeefabrikation. Oesterreichische Sanitätswesen, 1903, XV.
- WIECHMANN, F. Coffee and its adulterations. School of Mines Quarterly, 1897-8, I: 8-15.

## BOARD OF HEALTH REGULATIONS

- SCHNEIDER. Der Kaffee, als Gegenstand der medizinischen Polizei. Zeitschrift für die Staatsarzneikunde, 1829, IV:303-327.
- SCHÜTZE. Kaffee, Thee und Chocolate, als Nahrungsmittel und in sanitäts-polizeilicher Hinsicht. Vierteljahrsschrift für gerichtliche Medizin und öffentliches Sanitätswesen, 1860, XVII: 168-228.
- WEITENWEBER, W. R. Medicinisch-polizeiliche Bemerkungen über den Kaffee. Medicinische Jahrbücher des kaiserl. königl. österreichischen Staates, 1848, LXVI:42, 151.

## BOTANICAL DESCRIPTION

- COFFEA *stenophylla*. Royal Botanic Gardens, Kew, Bull. of Misc. Information, 1898:27.
- COOK, ORATOR FULLER. Dimorphic branches in tropical crop plants: cotton, coffee, cacao, the Central American rubber tree, and the banana. Washington, 1911. 64 pp. (U. S. Plant Industry Bureau. Bulletin, 198.)
- DAFERT, FRANZ W. Mittheilung aus dem Landwirtschaftsinstitut des Staates São Paulo, Brasilien. Der Nahrungstoff des Kaffeebaumes. Landw. Jahrb. 1894, XXIII:27-45.
- DOUGLAS, JAMES. Lillium sarniense: or, a description of the Guernsey-lilly. To which is added the botanical dissection of the coffee berry. London, 1725. 59 pp.
- LA ROQUE, JEAN. Voyage de l'Arabie heureuse, par l'Océan Oriental, & le détroit de la Mer Rouge. Fait par les François dans les années 1708, 1709 and 1710. Avec la relation d'un voyage fait du port de Moka à la cour du roy d'Yemen dans la 2. Expedition des années 1711, 1712 and 1713. Un mémoire concernant l'arbre et le fruit du café. Paris, 1716. 403 pp. Also in English, London, 1726. ✕
- LA ROQUE. Gruendliche und sichere Nachricht vom Cafee- und Cafee-Baum. Leipzig, 1717.
- LIBERIAN coffee. Royal Botanic Gardens, Kew, Bull. of Misc. Information, 1895:296-299.
- MCCLELLAND, T. B. The botany of coffee. Tea and Coffee Trade Journal, 1912, XXII:28-35.
- MARIANA, J. Les caféiers; structure anatomique de la feuille. Paris, 1908.
- NATURAL caffen-free coffee. Tea and Coffee Trade Journal, 1912, XXIII:230-233.
- NATURAL history of coffee, thee, chocolate, tobacco with a tract of elder and juniper berries. London, 1682.
- A NEW hybrid Ceylon coffee. Tea and Coffee Trade Journal, 1916, XXX: 232-233.
- SLOANE, Sir HANS. On the Bird the Cuntur of Peru and on the Coffee Shrub. London, 1694.
- WILDEMAN, É. DE Notes sur quelques espèces du genre Coffea L. Cong. internat. d. botanique. Actes, 1900, I:221-238.

## CHEMISTRY

## ANALYSIS, GENERAL

- ALLEN, A. H. Commercial organic analysis. London, 1892. (v. 3 pt. 2 contains a chapter on vegetable alkaloids, including coffee.)

\* Printed for E. Symon, over-against the Royal-Exchange, in Cornhill, 1732

- ANDALORI, ANDRÉ. Il caffè descritto ed esaminato. *Messine*, 1702.
- BOUSSINGAULT, J. B. J. D. Sur les matières sucrées contenues dans le fruit du caféier. *Ann. Inst. Nat. Agron.*, 1878-79, IV:1-4.
- CAFFÈ DI GIRASOLE: analisi chimiche, consigli agronomici, etc. *Padova*, 1881.
- COFFEE and chicory. Science readers and diagrams. Ser. 6, no. 3.
- GALEANO, JOSEPH. Il caffè, con piu diligenza esaminato. *Palermo*, 1674.
- GRIEBEL, C. Ueber den Kaffeegerbstoff. *München*, 1903.
- KÖNIG, J. Chemie der menschlichen Nahrungs- und Genussmittel. 4th ed. *Berlin*, 1904. See v. 2, index for Kaffee, Koffein.
- LOCKE, EDWIN A. Food values. *New York*, 1911. Coffee analyzed, p. 54.
- LYTHGOE, HERMANN CHARLES. Report on tea and coffee. *Washington*, 1905.
- MARCHAND, N. L. Recherches organographiques et organogéniques sur le Coffea arabica L. *Paris*, 1864.
- SESTINI, J. Il caffè; lettura fatta nell' istituto tecnico di Fochi. *Firenze*, 1868.
- STANDARDS of purity for food products. Tea, coffee and cocoa products. U. S. Dept. of Agriculture. Office of the Secretary. Circ. 19, p. 16.
- THORPE, EDWARD. Dictionary of applied chemistry. *London and New York*, 1912. See pp. 97-103.
- WANKLYN, JAMES ALFRED. Tea, coffee, and cocoa: a practical treatise on the analysis of tea, coffee, cocoa, chocolate, maté (Paraguay tea). *London*, 1874. 59 pp.
- WARNIER, W. L. A. Bijdrage tot de kennis der koffie, mededeeling uit het laboratorium van het Kolonial museum te Haarlem. *Amsterdam*, 1899. 23 pp.
- WEYRICH, R. Ein Beitrag zur Chemie des Thees und Kaffees. *Dorpat*, 1872.
- WILEY, H. W. Coffee and tea. In his, 1001 Tests of food, beverages and toilet accessories. pp. 10-18.
- WINTON, ANDREW L. The microscopy of coffee. In his, Microscopy of vegetable foods, *New York*, 1916. 2 ed. pp. 427-438. Reprinted, *Tea and Coffee Trade Journal*, XXI:22-28.
- Periodicals*
- ALLEN, A. H. Note on the examination of coffee. *Analyst*, 1880, V:1-4.
- BAU, A. The determination of oxalic acid in tea, coffee, marmalade, vegetables and bread. *Z. Nahr. Genussm.*, 1920, 40: 50-66.
- BEILLE, L. Les composés azotés et les bases puriques dans le caféier. *Revue de Botanique Appliquée et d'Agriculture Tropicale*, Jan., 1934: 54-63.
- BERTRAND, GABRIEL. Sur la composition chimique du café de la Grande Comore. *Comptes rendus de l'Académie des Sciences*, 1901, CXXXII:162-164.
- BINZ, C. Beiträge zur Kenntniss der Kaffeebestandtheile. *Archiv für experimentelle Pathologie und Pharmakologie*, 1878, IX:31-51.
- BÖTSCH, K. Zur Kenntniss der Saligeninderivate. *Monatshefte für Chemie (Sitzungsberichte der Kaiserlichen Akademie der Wissenschaften)* 1880, I:621-623.
- CANADA (DOMINION). INLAND REVENUE DEPARTMENT LABORATORY. Coffee: results of analysis. *Ottawa*, 1888. Bulletin, 3. 8 pp.; 1891, Bulletin, 29. 19 pp.; 1892, Bulletin 31. 13 pp.
- Ground coffee: results of analysis. *Ottawa*, 1904, Bulletin, 100. 7 pp.; 1909, Bulletin, 172. 37 pp.; 1910, Bulletin, 216. 22 pp.
- CAZENEUVE, P. and HADDON. Sur l'acide café-tannique. *Comptes rendus de l'Académie des Sciences*, 1897, CXXIV:1458-1460.
- CHARAUX, CHARLES. Sur l'acide chlorogénique. Fréquence et recherche de cet acide dans les végétaux. Extraction de l'acide caféique et rendement en l'acide caféique de quelques plantes. *Journal de Pharmacie et de Chimie*, 1900, 7. ser, II:292-298.
- THE CHEMISTRY of a cup of coffee. *Lancet*, 1913, II, no. 2: 1563-1565. Reviewed in, *Journal of Economics*, 1914, VI:466-467; *Literary Digest*, 1914, XLVIII:376-377.
- DOOLITTLE, R. E. and WRIGHT, B. B. Some effects of storage on coffee. *American Journal of Pharmacy*, 1915, LXXXVII:524-526.
- EHRlich, J. Coffee in the laboratory. *Tea and Coffee Trade Journal*, 1916, XXX:569-570.
- ERNI, H. The chemico-physiological relations of tea, coffee and alcohol. *Nashville Monthly Record of Medical and Physical Science*, 1858-9, I:641-656.
- FRANKEL, E. M. Coffee by-products. *Tea and Coffee Trade Journal*, 1917, XXXIII:43-44.
- Coffee identification. *The Tea and Coffee Trade Journal*, 1916, XXXI:158-159.
- FRANKEL, F. HULTON. Calories in a cup of coffee. *Tea and Coffee Trade Journal*, 1916, XXXI:446-447.
- GEISER, M. Welche Bestandteile des Kaffees sind die Träger der erregenden Wirkung? *Archiv für experimentelle Pathologie und Pharmakologie*, 1905, LIII:112-136.
- GORTER, K. Beiträge zur Kenntniss des Kaffees. *Annalen der Chemie*, 1907, CCCLVIII:327-348; 1908, CCCLIX:217-244; 1910, CCCLXII:237-246. Also, *East Indies, Dutch. Dept. van Landbouw. Bulletins*, 14, 33.
- GRAF, L. Ueber Bestandtheile der Kaffeensäuren. *Zeitschrift für angewandete Chemie*, 1901, pp. 1077-1082.
- Ueber den Zusammenhang von Coffeingehalt und Qualität bei chinesischem Thee. *Forschungsberichte über Lebensmittel*, 1897, IV:88.
- GUIGUES, P. Note sur l'origine du café. *Bulletin des Sciences pharmacologiques*, 1903, VII:350-357.
- HANAUSEK, T. F. Bemerkung zu dem Aufsatz von F. Netolitzky: Ueber das Vorkommen von Krystallsandzellen im Kaffee. *Zeitschrift für Untersuchung der Nahrungs- und Genussmittel*, 1911, XXI:295.
- Die Entwicklungsgeschichte der Frucht und des Samens von Coffea arabica L. *Zeitschrift für Nahrungsmittel Untersuchung und Hygiene*, 1890, IV:237-257.
- HARRIS, WILLIAM B. Scientific study of coffee. *Tea and Coffee Trade Journal*, 1915, XXIX:557-558.
- HEHNER, O. An analysis of coffee leaves. *Analyst*, 1879, IV:84.
- HERNDLHOFER, ERICH. Menge und Verteilung von Protein, Coffein, Mono- und Diaminosäuren in der Kaffeepflanze und deren monatliche Schwankungen während einer Vegetationsperiode. *Der Tropenpflanzer*, July, 1933:279-308.



- HOWARD, C. D. Report on tea and coffee. U. S. Chemistry Bureau. Bulletin, 1907, CV:41-45.
- HUSSON, C. Étude sur le café, le thé, et les chicorées. *Annales de Chimie et de Physique*, 1879, 5. ser. XVI: 419-427.
- JAFFA, M. E. Report on tea and coffee, 1910, with list of references. U. S. Chemistry Bureau. Bulletin, 1911, CXXXVII:105-108.
- LANCET special analytical sanitary commission on the composition and value of coffee extracts, *The Lancet*, 1894, II:43-45.
- LEPPER, H. A. Report on coffee. *Journal of the Association of Official Agricultural Chemists*, 1920, 4:211-216.
- LEVESIE, O. Beiträge zur Chemie des Kaffees. *Archiv der Pharmacie*, 1876, 3 ser. VIII:294-298.
- LIEBIG, J. von. Chemistry of a cup of coffee. *Every Saturday*, I:135.
- LOOMIS, H. M. Report on tea and coffee. *Journal of the Association of Official Agricultural Chemists*, 1920, 3:498-503.
- MASON, G. and SAVINI E. Experiments with coffee. *Staz. sper. agrar. ital.*, 1918, 51:413-4.
- MAZZA, C. Sull' esame batteriologico della polvere che si trova negli spacci di caffè, con speciale riguardo al bacillo della tubercolosi. *Rivista d'Igiene e Sanità pubblica*, 1897, VIII:8-20.
- PALADINO, PIETRO. Sopra un nuovo alcaloide contenuto nel caffè. *Gazette Chimica Italiana*, XXV:104-110. Summarized in, *Beilstein's Organische Chemie*, 1897, III:888.
- PARET, S. A. Quelques résultats obtenus par l'emploi du valerianate de caféine (thèse). *Paris*, 1874.
- PAYEN, EDOUARD. Mémoire sur le café. *Comptes rendus de l'Académie des Sciences*, 1846, XXII: 724-732; XXIII:8-15, 144-251.
- PRATT, DAVID S. The microscopy of tea and coffee. *Tea and Coffee Trade Journal*, 1915, XXIX: 419-421.
- PRESCOTT, A. Chemistry of tea and coffee. *Popular Science Monthly*, XX:359.
- ROBIQUET, VON, and BOUTRON. Ueber den Kaffee. *Annalen der Chemie*, 1837, XXIII:93-95.
- ROBISON, FLOYD W. What do we know about coffee? *Tea and Coffee Trade Journal*, 1916, XXXI:556-562.
- SAYRE, L. E. A pharmacologist on coffee. *Tea and Coffee Trade Journal*, 1917, XXXII:521-527.
- Coffee, its standardization and application to pharmacy. *Merck's Report*, 1907, XVI:61-63.
- SOME new facts about coffee. *The Tea and Coffee Trade Journal*, 1918, XXXV:436-437.
- STREET, JOHN PHILLIPS. About hygienic coffees. *Tea and Coffee Trade Journal*, 1916, XXXI: 52-54.
- Hygienic coffee analyses. *Tea and Coffee Trade Journal*, 1917, XXXIII:42-43.
- Recent coffee analyses. *Modern Hospital*, 1916: 330-332. Reprinted in *Tea and Coffee Trade Journal*. XXX:570-572.
- TATLOCK, R. R. and THOMSON, R. T. The analysis and composition of coffee, chicory, and coffee and chicory "essences." *Journal of the Society of Chemical Industries*, 1910, XXIX:138-140.
- TRIGG, CHARLES W. Caffetannic acid a bugaboo. *Tea and Coffee Trade Journal*, 1917, XXXIII: 437-439.
- Coffee oil and fats. *The Tea and Coffee Trade Journal*, 1918, XXXV:230-231.
- Coffee carbohydrates. *The Tea and Coffee Trade Journal*, 1919, XXXVI:246-247.
- TUSINI, F. Sul riconoscimento delle varie specie di grani di caffè, mediante la misurazione delle cellule del reticolo albuminoideo e dello spermoderma. *Archivio di Farmacologia sperimentale e Science affini*, 1903, II:215-217.
- VAUTIER, E. The wastes of coffee. *Mitt. Lebensm. Hyg.*, 1921, 12:35-37.
- VANDER WOLK, P. C. New researches into some statistics of Coffea. *Zeitschrift für inductive Abstammungs- und Vererbungslehre*, 1914, XI: 355-359.
- VLAANDEREN, C. L. and MULDER, G. J. Säuren des Kaffees. *Jahresbericht der Chemie*, 1858:261-264.
- WARNIER, W. L. A. Contributions à la connaissance du café. *Recueil de Travaux chimiques du Pays-Bas de la Belgique*, 1899, 2. ser. III:351-357.
- WILLCOX, O. W. Coffee aroma secret out. *Tea and Coffee Trade Journal*, 1913, XXV:343-344.
- Tannin in coffee. *Tea and Coffee Trade Journal*, 1913, XXV:485.
- WILLCOX, O. W. and RENTSCHLER, M. J. Scientific analysis of coffee. *Tea and Coffee Trade Journal*, 1910, XIX:440-443; 1911, XX:30-34, 109-111, 194-195, 355-356.
- WOODMAN, A. G. Report on tea, coffee, and cocoa products, 1909. U. S. Chemistry Bureau. Bulletin, 1910, CXXXII:134-136.

## CAFFEINE

- CLAUTRIAU, G. Nature et signification des alcaloïdes végétaux. *Paris*, 1907:113.
- DRAGENDORF, GEORG. Caffeïn und Theobromin. In his, *Die gerichtlich-chemische Ermittlung von Giften*, pp. 202-206.
- FENDLER, G. and STÜBER, W. Coffeinbestimmungen im Kaffee. *Zeitschrift für Untersuchung der Nahrungs- und Genussmittel*, 1914, XXVIII: 9-20.
- FISCHER, EMIL. Ueber das Caffeïn. *Berichte der deutschen chemischen Gesellschaft*, 1882, XV, no. 5:29-37.
- FRANKEL, E. M. Caffeine and theine. *Tea and Coffee Trade Journal*, 1916, XXXI:260.
- FRENCH, J. M. Caffeïn, its sources and uses. *Mercks Archives*, 1907, IX:208.
- JOBST, CARL. Thein identisch mit Caffeïn. *Annalen der Chemie*, 1838, XXV:63-66.
- LANGLOIS, P. Kola et caféine. *La Science Illustrée*, July, 1890.
- LENDRICH, K. and NOTTBOHM, E. Verfahren zur Bestimmung des Coffeïns im Kaffee. *Zeitschrift für Untersuchung der Nahrungs- und Genussmittel*, 1909, XVI:241-265.
- LYON, NORMAN W. The effects of caffeïn upon mental and motor functions. *Columbia University, New York*, 1930.
- PAUL, B. H. and COWNLEY, A. J. The amount of caffeïn in various kinds of coffee. *Pharmaceutical Journal*, 1887, 3 ser. XVII:565.
- PFÄFF, C. H. Ueber die Darstellung des Coffeïns, über dessen charakteristische Eigenschaften und dessen Mischung, über zwei Säuren im Kaffee, so wie über das sogenannte Kaffee-Grün. *Neues Jahrbuch der Chemie und Physik*, 1831, I:487-503; II:31-45.
- POLSTORFF, KARL. Ueber das Vorkommen von Betainen und von Cholin in Kaffeein und Theobromin enthaltenden Drogen. *Chemisches Zentralblatt*, 1909, 5 ser. XIII:2014-2015.

- STEHLE, R. L. Caffeine, the alkaloid. *Tea and Coffee Trade Journal*, 1917, XXXII:46-47.
- SULLIVAN, A. L. Determination of caffeine in coffee, a comparison of the Hilger and Fricke method with a modification of the Gomberg method. *Science*, 1909, XXX:255.
- WILLCOX, O. W. Coffee and caffeine. *Tea and Coffee Trade Journal*, 1913, XXIV:460-461.
- WINSOR, A. L. and STRONGIN, E. I. A study of the development of tolerance for caffeinated beverages. *Journal of Experimental Psychology*, 1933, XVI, no. 5.
- CAFFEINE-FREE COFFEE
- PRITZKER, J. and JUNGKUNZ, ROB. Beiträge zur kenntnis des natürlichen und koffeinfreien kaffees. *Zeitschrift zur Untersuchung der Lebensmittel*, 1926, LI:97-114.
- RABENHORST, W. and VARGES, J. Koffeinfreier Kaffee; enthält der koffeinfreie Kaffee fremde chemische Bestandteile, insbesondere Ammoniak, Benzol, Salzsäure, Schwefelsäure? *Medizinische Klinik*, 1908, IV:1612.
- SALANT, WILLIAM, and RIEGER, J. B. Elimination of caffeine: an experimental study of herbivora and carnivora. U. S. Dept. of Agriculture. Chemistry Bureau. *Bulletin*, CLVII.
- TRIGG, CHARLES W. About caffeine-free coffee. *Tea and Coffee Trade Journal*, 1918, XXXIV:233.
- WILLCOX, O. W. "Caffeine-free" coffee. *Tea and Coffee Trade Journal*, 1911, XX:116.
- CAFFEOL
- BERNHEIMER, OSCAR. Zur Kenntniss der Röstprodukte des Caffeos. *Monatshefte für Chemie (Sitzungsberichte der Kaiserlichen Akademie der Wissenschaften)* 1880, I:456-457.
- BERTRAND, G and WEISWEILLER, G. Sur la composition de l'essence de café; présence de la pyridine. *Comptes rendus de l'Académie des Sciences*, 1913, CLVII:212-213. Also, *Bulletin des Sciences pharmacologiques*, 1905, XII:152.
- EDMANN, ERNST. Ueber das Kaffeöl und die Physiologische Wirkung des darin enthaltenen Furfuralkohols. *Archiv für experimentelle Pathologie und Pharmakologie*, 1902, XLVIII:233-261. Also, *Berichte der deutschen chemischen Gesellschaft*, 1902, XXXV:1846.
- Beitrag zur kenntnis der kaffeeöles und des darin enthaltenen furfuralkohols. *Halle*, 1902:46.
- GRAFE, V. Untersuchung über die Herkunft des Kaffeöls. *Anzeiger der Kaiserlichen Akademie der Wissenschaften*, 1912, XLIX:267-268.
- JAERLE, H. Studien über die Produkte der Kaffeeröstung ein Beitrag zur Kenntniss des sogenannten Kaffeearomas (Caffeol.) *Zeitschrift für Untersuchung der Nahrungs- und Genussmittel*, 1898, 457-472.
- ORLOWSKI, A. Kilka slor o kawie palonój. (Extract of Coffee.) *Gazeta Lekarska, Warsaw*, 1870, IX:385-387.
- THE CAFFEOL in roasted coffee. *Tea and Coffee Trade Journal*, 1913, XXIV:241.
- TRIGG, CHARLES W. The aroma of coffee. *Tea and Coffee Trade Journal*, 1918, XXXV:37-39.
- GREEN COFFEE
- BITTÓ, BELA VON. Ueber die chemische Zusammensetzung der inneren Fruchtschale der Kaffee Frucht. *Jour. Landw.* III:93-95.
- HERFELDT, E. and STUTZER, A. Untersuchungen über den Gehalt der Kaffeebohnen an Fett, Zucker und Kaffeegerbsäure. *Zeitschrift für angewandte Chemie*, 1895, 469-471.
- MEYER, H. and ECKERT, A. Ueber das fette öl und das Wachs der Kaffeebohnen. Summarized in, *Anzeiger der Kaiserlichen Akademie der Wissenschaften*, 1910, XLVII:320.
- ROCHLEDER, F. Notiz über die Kaffeebohnen. *Annalen der Chemie*, 1844, L:234-244; 1846, LIX:300-310; 1852, LXXXII:194.
- TRIGG, CHARLES W. Aging green coffee. *Tea and Coffee Trade Journal*, 1920, XXXIX:440.
- ZWENGER, C. and SIEBERT, S. Ueber das Vorkommen der Chinasäure in den Kaffeebohnen. *Annalen der Chemie*, 1861, 1 sup. pp. 77-85.
- ROASTED COFFEE
- BURMANN, J. Recherches chimiques et physiologiques sur les principes nocifs du café torréfié. *Bulletin général de Thérapeutique*, 1913, CLXVI:379-400.
- EHRlich, J. In a cup of coffee. A consideration of the constituents of the roasted bean and of the sugar, milk or cream that goes with it. *Tea and Coffee Trade Journal*, 1916, XXX:547-549.
- GOBLET, L. Analyses comparées d'un café torréfié par des procédés différents. *Association Belge des Chimistes. Bulletin*, 1899, XIII:172-173.
- GOULD, R. A. The gases evolved from roasted coffee, their composition and origin. *Eighth International Congress of Applied Chemistry. Report*, 1912, XXVI:389.
- LENDRICH, K. and NOTTBOHN, E. Ueber den Caffeingehalt des Kaffees und den Caffeinverlust beim Rösten des Kaffees. *Zeitschrift für Untersuchung der Nahrungs- und Genussmittel*, 1909, XVIII:299-308.
- LYTHGOE, H. Chemical analyses of a few varieties of roasted coffee. *Technology Quarterly*, 1905, XVII:236-239.
- MONARI, A. and SCOCCIANTI, L. La pyridine dans les produits de la torréfaction du café. *Congrès international d'Hygiène et de Démographie. Comptes rendus*, 1894, VIII: pt. 4, 211. Also, *Archives italiennes de Biologie*, 1895, XXIII:68-70; *Chemisches Zentralblatt*, 1895, I:750.
- TRIGG, CHARLES W. Coffee roasting. *Tea and Coffee Trade Journal*, 1919, XXXVII:170-172.
- Gases from roasted coffee. *Tea and Coffee Trade Journal*, 1920, XXXIX:318.
- CHICORY
- BACKER, P. La culture du witloof. *Thielt*, 1912:22. —De teelt van witloof. *Thielt*, 1911:23.
- BORUTTAU, H. Die physiologische Wirkung des Absudes der gebrannten Zichorie. *Medizinische Klinik*, 1907, III:644-647.
- FRIES, M. Praktische Anleitung zum Kaffee Cichorienbau. *Stuttgart*, 1886.
- KAINS, M. G. Chicory growing. *Washington*, 1900:12.
- Chicory growing as an addition to the resources of the American farmer. *Washington*, 1898:52.
- OLIVER, S. W. Why chicory as an addition to coffee? Facts about this product, its origin and development. *Tea and Coffee Trade Journal*, 1932, LXIII:440-444.
- SCHMIEDEBERG, OSWALD. Historische und experimentelle Untersuchungen über die Zichorie und den Zichorienkaffee in diätetischer und gesund-

- heitlicher Beziehung. *Archiv für Hygiene*, 1912, LXXVI:210-244.
- WEISMANN, R. Ueber den schädlichen Einfluss von Zichorienaufguss. *Aerztliche Rundschau*, 1908, XVIII:183.
- ZELLNER, H. Zichorie. *Centralblatt für allgemeine Gesundheitspflege*, 1908, XXVII:32-39.
- CHICORY IN COFFEE
- CAUVET. Sur l'examen et l'analyse des échantillons de café-chicorée et de café moulu saisis chez divers marchands de Constantine. *Annales d'Hygiène*, 1873, XI:302-317.
- CHEVALIER, A. Notice historique et chronologique sur les substances qui ont été proposées comme succédanées du café et sur le café-chicorée en particulier. *Moniteur d'Hôpitaux*, 1853, I:1129, 1161, 1171, 1185, 1193, 1217.
- CLOÛET, J. Du café-chicorée; empoisonnement de quatre personnes par l'usage de cette denrée. *Mouvement médicale*, 1875, XIII:505.
- FORSEY, C. B. The new coffee and chicory regulations. *Analyst*, 1882, VII:159.
- GUILLON, CAMILLE. La chicorée et divers produits de substitution du café. *Lons-le-Saunier*, 1911, 352 pp.
- LAWALL, C. H. and FORMAN L. The detection of chicory in decoctions of chicory and coffee. *Journal of the American Pharmaceutical Association*, 1914, III:1669.
- LEEBOODY, J. R. Estimation of chicory in coffee. *Chemical News*, 1874, XXX:243.
- MORIN. Quelques réflexions sur un des moyens employés pour déterminer la présence du café chicorée dans le café normal. *Rouen*, 1863, 5 pp. (Extrait des Mémoires de l'Académie de Caen.)
- ON the adulteration of chicory and coffee. *Lancet*, 1861, II:18.
- COFFEE HOUSES
- BREWSTER, H. POMEROY. The coffee houses and tea gardens of old London. *Rochester*, 1888.
- CAFÉS de Paris par un flaneur patenté. 1849.
- COFFEE public house, The. How to establish and manage it. *London*, 1878, 34 pp.
- COFFEE stalls and taverns: hints on coffee stall management. *London*, 1886, 40 pp.
- COLMAN, GEORGE and THORNTON, B. Survey of the town. . . Garraway's, Batson's St. Paul's, and the Chapter coffee houses. In their, *The Connoisseur*. *Oxford*, 1757, I:1-10.
- CUNOW, HEINRICH. Politische Kaffeehäuser; Pariser Silhouetten aus der grossen französischen Revolution. *Berlin*, 1925.
- DAFERT, F. W. Erfahrungen über rationellen Kaffeebau. *Berlin*, 1896, 36 pp. 2nd ed., 1899, 60 pp.
- DELVAU. Histoire anecdotique des cafés et cabarets de Paris. 1861.
- HAWES, C. W. Handbook to coffee taverns. *Uxbridge*, 1888, 17 pp.
- MACAULAY, T. B. (Coffee houses in the 17th and 18th centuries.) In his, *History of England*. I:334-336.
- MICHEL, FRANCISQUE, et FOURNIER, ÉDOUARD. Histoire des hôtelleries, cabarets et cafés. 1854.
- REID, THOMAS WILSON, ed. Traits and stories of Ye Olde Cheshire Cheese. *London*, 1886, 133 pp.
- ROBINSON, EDWARD FORBES. Early history of coffee houses in England. *London*, 1893, 240 pp.
- SHELLEY, CHARLES HENRY. Inns and taverns of old London. *Boston*, 1909, 366 pp.
- Old Paris. *Boston*, 1912.
- TIMBS, J. Clubs and club life in London, with anecdotes of its famous coffee houses, hostelrys and taverns. *London*, 1866, 2v. 2nd ed., 1872, 1v. 544 pp.
- Periodicals
- ANDREWS, A. Coffee houses and their clubs in the 18th century. *Colburn's New Monthly Magazine*, CVI:107.
- BETHEL, CHRISTIAN MISSION, Providence. Annual report. . . constitution, by-laws, etc.
- BUSS, GEORGE. Kaffee und Kaffeehäuser. *Westerman's Monatshefte*, Sept. 1908:805-821.
- COFFEE house movement. *Chambers' Journal*, LVI:143.
- COFFEE house news. *London Magazine*, XX:563.
- COFFEE houses of old London. *The Tea and Coffee Trade Journal*, 1918, XXXV:116-125.
- COFFEE Houses of old New York. *The Tea and Coffee Trade Journal*, 1920, XXXVIII:160-174.
- COFFEE Houses of old Philadelphia. *The Tea and Coffee Trade Journal*, 1920, XXXVIII:308-312.
- COFFEE Houses of the Restoration. *Tait*, n. s. XXII:104; *Ecclesiastical Magazine*, XXIV:500.
- COFFEE palaces. *All-the-Year*, LII:520.
- DAWSON, WARREN R. The London coffee houses and the beginnings of Lloyd's. *British Archaeological Association Journal*, 1934, XL:104-134.
- EARLY Parisian coffee houses. *The Tea and Coffee Trade Journal*, 1918, XXXV:526-534.
- EIPPER, PAUL. Pariser Cafehäuser. *Westermanns Monatshefte*, 1927, CXLII:565-572.
- FOX, S. Coffee club movement in California. *Arena*, XXXII:519.
- GRAHAM, R. Coffee houses as a counter action to the saloon. *Charities Review*, I:215.
- HALL, E. H. Coffee taverns. *Leisure Hour*, XXVIII:301.
- HILL, E. Coffee and coffee houses. *Gentleman's Magazine*, n. s. LXXI:47.
- HOBSON, J. G. S. The coffee house. *Blackwoods Magazine*, 1933, CCXXXIV:201-217.
- HOLLAND and the café Krasnapolsky at Amsterdam. *Idler*, 1899, XVI:31-39.
- HOPE, LADY. Coffee rooms for the people. *Good Words*, XXI:749, 844.
- HOWERTH, I. W. Coffee house as a rival of the saloon. *American Magazine of Civics*, VI:589.
- HUMPHREYS, J. Coffee houses. *St. James Magazine*, XLIII:598.
- JARVIS, A. W. Old London coffee houses. *English Illustrated Magazine*, 1900, XXIII:107-114.
- PAGE, H. A. Coffee palaces. *Good Words*, XVIII:678.
- RODENBERG, J. Die kaffeehäuser und clubs von London. *Unsere Zeitung*, 1866, II:177-265.
- SCHMITT, E. Volkskuechen und speiseanstalten fuer arbeiter; Volkskaffeehäuser. *Handbook der Architek*, 4 theil, IV:116.
- SIKES, W. English coffee palaces. *Lippincott's Magazine*, XXIV:728.
- SOME old London coffee houses. *Cornhill Magazine*, LVI:527.
- STEVENS, J. A. Coffee houses of old New York. *Harper's Magazine*, LXIV:481.
- STIELER, ALFRED. Berliner Kaffeehäuser von heute. *Westermanns Monatshefte*, 1930, IV:257-264.

- SWEETSEER, ARTHUR LAWRENCE. The coffee house plan. *Gunton's Magazine*, 1901, XXI:239-245.
- THOMAS, C. EDGAR. Some London coffee houses. *Home Counties Magazine*, 1911, XIII:1-9, 91-100.
- WAGNER, H. Shankstættten und speisewirtschaften; Kaffeehäuser und restaurants. *Handbook der Architek*, 4 theil, IV:116 pp.
- CULTURE AND PREPARATION
- GENERAL
- ALVARADO, JUAN ANTONIO. Tratado de Caficultura. Vol. i. *Guatemala*, 1935.
- AMERICAN COFFEE GROWERS' ASSOCIATION. Coffee growing by proxy. *New York*, 1895. 30 pp.
- ARNOLD, EDWIN LESTER LINDEN. Coffee: its cultivation and profit. *London*, 1886. 270 pp.
- BECKLEY, V. A. Fermentation of coffee. *Nairobi*, 1931.
- BOËRY, PASCAL. Les plantes oléagineuses et leurs produits; cacao, café. . . *Paris*, 1888.
- BOURGOIN D'ORLI, P. H. F. Guide pratique de la culture du caféier et du cacaoier suivi de la fabrication du chocolat. *Paris*, 1876.
- BROUGIER, A. Der Kaffee, dessen Kultur und Handel. 1897.
- BROWN, ALEXANDER. The coffee planter's manual, with which is added a variety of information useful to planters, including the manuring of coffee-estates. *Colombo*, 1880. 246 pp.
- BROWNE, D. J. On the cultivation of coffee. *Washington*, 1859. 12 pp.
- BURLAMAQUI, FREDERICO LEOPOLDO CÉSAR. Monographia do caféiro e do café. *Rio de Janeiro*, 1860. 62 pp.
- CIVINNI, G. D. Delle storie naturæ del caffè. *Firenze*, 1731.
- COOK, ORATOR FULLER. Shade in coffee culture. *Washington*, 1901. 79 pp.
- CUEVAS, HILARIO. Estudio práctico sobre el cultivo del café. *México*, 1895. 50 pp.
- CUNHO, AGOSTINO RODRIGUEZ. De l'art de la culture du café et de sa propagation. *Rio de Janeiro*, 1844.
- D'ORLI, P. H. F. BOURGOIN. Culture du café, etc. *Paris*, 1874.
- FAUCHÈRE, A. Culture pratique du caféier et préparation du café. *Paris*, 1908. 198 pp.
- FERGUSON, JOHN. The coffee planter's manual for both the Arabian and Liberian species. *Colombo*, 1898. 312 pp.
- FUCHS, M. Die geographische Verbreitung des Kaffeebäume. *Leipzig*, 1886. 72 pp.
- GABVENS, WILHELM. Kaffee: Kultur, Handel und Bereitung im Produktionslande. 2 ed. *Hannover*, 1913. 45 pp.
- GREAT BRITAIN. Parliament, House of Commons. First report from the Select committee on sugar and coffee planting. *London*, 1848:8v.
- Supplement to the report. *London*, 1848. 198 pp.
- HANSON, R. Culture and commerce of coffee. *London*, 1877.
- HERRERA, RAFAEL. Estudio sobre la producción del café. *México*, 1893. 141 pp.
- HUNTINGTON, L. M. Origin of oily coffee beans. *The Tea and Coffee Trade Journal*, 1917, XXXIII:228.
- INTERNATIONAL BUREAU OF THE AMERICAN REPUBLICS, *Washington, D. C.* Coffee in America. Methods of production and facilities for successful cultivation in Mexico, the Central American states, Brazil and other South American countries, and the West Indies. 1893. 36 pp.
- JACOTOT, A. La culture du café, son avenir dans les colonies françaises. *Paris*, 1910. 191 pp.
- JIMENEZ NÚÑEZ, ENRIQUE. Medios prácticos para evitar que las mieles de café infecten las aguas de los rios. *Guadalupe*, 1902.
- JOTAPEN, JOSÉ. Cultivation and preparation of coffee for the market. *Aberdeen*, 1915. 102 pp.
- JUMELLE, HENRI. Plantes à sucre, café, cacao, thé, maté. In his, *Les cultures coloniales*. *Paris*, 1913. v.3.
- KRAMERS, J. G. Verslag omtrent de proeftuinen en andere mededeelingen over koffie. *Batavia*, 1899-1904. 4v.
- LAERNE, C. F. VAN DELDEN. Brazil and Java. Report on coffee culture in America, Asia and Africa, to H. E. the minister of the colonies. *London*, 1885. 637 pp. Also in Dutch and French.
- LASCELES, ARTHUR ROWLEY WILLIAM. A treatise on the nature and cultivation of coffee; with some remarks on the management and purchase of coffee estates. *London*, 1865. 71 pp.
- LE COMTE, C. E. A. Culture et production du café dans les colonies. *Paris*, 1865.
- LÉCOMTE, HENRI. Le café: culture, manipulation, production. *Paris*, 1899. 342 pp.
- LIEVANO, INDALECIO. Instrucción popular sobre meteorología agrícola, i especialmente sobre el añil i el café. *Bogota*, 1868. 18 pp.
- MCCLELLAND, T. B. Effect of different methods of transplanting coffee. *Washington*, 1917. 11 pp.
- Some profitable and unprofitable coffee lands *Washington*, 1917. 13 pp.
- MCCULLOCH, R. WILLIAM. Coffee-growing and its preparation for market. *Brisbane, Australia*, 1893.
- MADRIZ, F. J. Cultivo del café seu manual theoricopratico sobre beneficio de este frutè con mayores ventajas para al agricultor. *Paris*, 1869.
- MEITZKY, JO.-HENRY. De vario coffeè potum parandi modo. *Wittebergiae*, 1788.
- MIDDLETON, W. H. Manual of coffee planting. *Durban*, 1866.
- MILHON. Dissertation sur le caffeyer. *Montpellier*, 1746.
- MONNEREAU, ÉLIE. Le parfait indigotier; ou Description de l'indigo. . . ensemble un traité sur la culture de café. *Amsterdam and Marseilles*, 1765. 238 pp.
- MORREN, F. W. Die arbeiter auf einer Kaffeeplantage. 1900.
- Werkzaamheden op eene koffieonderneming. Handleiding voor opzichters bij de koffie-cultuur. *Amsterdam*, 1896. 266 pp.
- NICOL, R. A treatise on coffee, its properties and the best mode of keeping and preparing it. 4th ed. *London*, 1832.
- OWEN, T. C. First year's work on a coffee plantation. *Colombo*, 1877. 55 pp.
- PIETTRE, MAURICE. Production industrielle du café; terres vierges et sols fatigués; a la recherche de l'humus. *Paris*, 1925.
- PIERROT, ÉDOUARD. Culture pratique et rationnelle du caféier et préparation du grain pour la vente. *Paris*, 1906. 95 pp.
- POMPEU DO AMARAL, ABELARDO. Cultura pratica e racional do cafeeiro. *São Paulo*, 1925. 607 pp.
- ROSSIGNEN, JULIO. Manual del cultivo del café etc., in la America Española. *Paris*, 1859.

- SIMMONDS, P. L. Coffee and chicory, their culture, chemical composition, preparation, etc. *London*, 1864. 102 pp.
- Tropical agriculture. *London*, 1887. (pp. 27-79 deal with coffee.)
- TYTLER, R. B. Prospects of coffee production. *Aberdeen*, 1878.
- UGARTE, JOSÉ P. The cultivation and preparation of coffee for the market. *London*, 1916. 124 pp.
- VILLARES, JORGE DUMONT. O café, sua produção e exportação (Part I); O café cultura, produção e commercio (Part II). *São Paulo*, 1927.
- WILDEMAN, EM. DE. Les caféiers. *Bruxelles*, 1901.
- Les plantes tropicales de grande culture—café, cacao, coca, vanilla, etc. *Bruxelles*, 1902. 304 pp.
- ZIMMERMANN, ALBRECHT. Over het enten van koffie volgens de methode van den Heer D. Butin Schaap. *Batavia*, 1904. 54 pp.
- Periodicals*
- AUBRY-LE-COMTE. Culture et production du café dans les colonies. *Revue Mar. et Col.*, Oct., 1865.
- BEUGLESS, J. D. Coffee in its home. *Overland Monthly*, II:319.
- CASWELL, G. W. Coffee in our new islands. *Overland Monthly*, n. s. XXXII:459.
- CHEVALIER, AUG. Le problème de la culture du caféier dans les Colonies françaises. *Comptes Rendus Hebdomadaires des Séances de l'Académie d'Agriculture de France*, June, 1933: 707-712.
- COFFEE cultivation in the New World. *Royal Botanic Gardens, Kew, Bull. of Misc. Information*, 1893:321-325.
- CRAMER, P. J. S. Coffee excelsa. *Actes et Comptes Rendus de l'Assoc. Colonies-Sciences*, 1933, IX: 21-30.
- CULTIVATION and preparation of coffee. Great Britain. *Imperial Institute, Bulletin*, 1915, XIII.
- DE VERE, M. S. Culture and use of coffee. *Harper's Magazine*, XLIV:237.
- FASCHDJIAN, EDGAR. Observations concernant la variabilité, la dominance et le vicinisme chez le *Coffea arabica*. *Bulletin Economique de l'Indochine*, 1932, XXXV:531B-539B.
- FERWERDA, F. P. The vegetative propagation of coffee. *Empire Journal of Experimental Agriculture*, 1934, II:189-199.
- FESCA, MAX. Ueber Kaffeekultur. *Jour. Landw.* 1897, XLV:13-41.
- FIGUEROA, CABLOS ARTURO. Pruning of the coffee tree. *Proceedings of the Agricultural Society of Trinidad & Tobago*, 1932, XXXII:424-431.
- FRANÇOIS, EDMOND. La culture du caféier d'Arabie dans les états de l'Est Africain. *Gouvernement General de Madagascar et Dependances Bulletin Economique Mensuel*, 1931, LI:63-79.
- GRAFTED coffee. *The Planter*, 1933, Vol. I, no. 12.
- HAGEN, J. De Koffiecultuur. *Onze Kol. Landbouw No. 7*. 1914.
- HAYWARD, C. B. Coffee and coffee culture. *Scientific American*, 1904, XCI:189, 194-195.
- HOEDT, TH. G. E. Notes on pruning coffee. *Archief voor de Koffiecultuur in Nederlandsch-Indië*, 1932, no. 2, VI:57-86.
- HOLLAND, T. H. The green manuring of tea, coffee, and cacao. *The Tropical Agriculturist*, 1931, LXXVII, 3:139-166.
- JACQUES, CHARLES. Le caféier. *Revue Agricole, Chambre d'Agriculture de la Nouvelle Calédonie*, Aug.-Sept., 1932:794-845.
- JOLY, R. L. Particularités sur la culture du Caféier. *Bulletin de la Société des Recherches Congolaises*, 1932, XVII:63-67.
- KNAUS, C. Drogen en sorteeren van koffie. *De Bergcultures*, 1931, L:1401-1406.
- LINNEAN SOCIETY. *Proceedings*, 1875-1880, contain articles on coffee culture.
- LOEW, OSCAR. Fermentation of cacao and of coffee. *Porto Rico Agricultural Experiment Station. Report*, 1907. pp. 41-55.
- MCDONALD, J. H. Le triage et la préparation du café. *Agriculture et Elevage au Congo Belge*, 1931, nos. 18, 20.
- MARCANO, V. Essais d'agronomie tropicale. *Ann. sci. agron.* 1891, II:119-152.
- MARSHALL, T. H. Coffee grafting and budding. *Planter, E. Africa*, 1934, no. 3, III:10-12.
- MAYNE, W. W. The function of spraying in coffee crop production. *The Planters' Chronicle*, 1933, XXVIII:34-38 and 53-56.
- NUTMAN, F. J. The root-system of *Coffea arabica*. *Emp. Jour. Exper. Agric.*, 1933, I:271-284.
- PEATFIELD, J. J. Culture of coffee. *Overland Monthly*, XIII:323.
- ROST, EUGEN C. Coffee growing. *Scientific American Supplement*, 1902, LIV:22189-22190.
- SÉLECTION du caféier. *Bulletin Economique de l'Indochine*, March-April, 1934:343-355.
- SLADDEN, G. E. La désinfection de la semence de café. *Bulletin Agricole du Congo Belge*, Sept., 1932:329-337.
- La taille du caféier. *Bulletin Agricole du Congo Belge*, 1933, IV:400-417.
- L'établissement des pépinières de caféiers. *Agriculture et Elevage au Congo Belge*, Feb., 1933:25-27.
- La sélection du caféier. *Journées d'Agronomie Coloniale*, June 1933:182-190.
- SNOEP, W. Over cultuurmaatregelen betreffende bodembehandeling en schaduw bij koffie. *De Bergcultures*, 1932, LII:1413-1417; LIII:1450-1453.
- TORRENS, J. H. Hydro-electric installation on a coffee plantation. *General Electric Review*, 1915, XVIII:219-222.
- Electricity on a coffee finca. *The Tea and Coffee Trade Journal*, 1916, XXXI:418-421.
- ULTEE, A. J. Enkele beschouwingen over de robusta cultuur. *De Bergcultures*, 1932, XXX: 774-777.
- REGIONAL
- ABYSSINIA (ETHIOPIA)
- BIEBER, FREDERICH J. Die Kaffee- und Baumwolle-Kultur in Kaffa. *Zeitschrift für Kolonialpolitik, Kolonialrecht und Kolonialwirtschaft*, 1908, X:774-781.
- INCREASED growing of Ethiopian coffee. *Tea and Coffee Trade Journal*, June, 1935, lxviii:464-468.
- SOUTHARD, ADDISON E. The story of Abyssinia's coffees. *Tea and Coffee Trade Journal*, 1918, XXXIV:212-215; 324-329.
- AFRICA (MISCELLANEOUS)
- KADEN, O. F. Erfahrungen im kaffeesschnitt Westafrikas. *Tropenpflanzer*, 1934, XXXVII: 367-378.
- MCDONALD, J. H. Coffee growing; with special reference to East Africa. *London*, 1930.
- RIVIÈRE, CHARLES. Le caféier dans l'Afrique du nord. *Paris*, 1903.



## ANGOLA

- BRAUN, R. Betrachtungen über Kaffeekulturen auf Savannenboden in Nordangola. Der Tropenpflanzer, 1932, no. 10, XXXV:433-440.
- COFFEE cultivation in Angola. Royal Botanic Gardens, *Kew*, Bull. of Misc. Information, 1894: 161-153.
- JANSSENS, PAUL. Le café robusta dans l'Angola. Bulletin Agricole du Congo Belge, 1931, XXI, no. 3:949-953.

## ARGENTINE

- ARGENTINE REPUBLIC. Departamento nacional de tierras, colonias y agricultura. El café. (Coffea arábica) *Buenos Aires*, 1896. 22 pp.

## AUSTRALIA

- JACKSON, HENRY VAUGHAN. The cultivation of coffee. *Sydney*, 1908. 8 pp. Reprinted from *Agricultural Gazette*, June, 1908.
- NEWPORT, H. Coffee cultivation in Queensland. *Philippine Agricultural Review*, 1910, III:514-524. Also, *Queensland Agricultural Journal*, 1910, XXIV, pt. 6; XXV, pt. 1.

## BELGIAN CONGO

- ALLONCIUS, C. J. Le café au Congo Belge. Association pour le Perfectionnement du Matériel Colonial, Nov. 1932:39-63.
- DECRAENE, A. Note sur l'ombrage dans les plantations de caféiers Arabica de la région de Mulungu-Katana (Kivu). *Journées d'Agronomie Coloniale*, June 1933:233-240.
- KERMANS, H. Les cafés du Congo Belge. Bulletin Agricole du Congo Belge, 1931, XXI, 3:954-956.
- L'HEUREUX, L. Expertises de cafés provenant du Congo Belge. *Journées d'Agronomie Coloniale*, June 1933:241-255.
- LEPLAE, EDM. Comment on cultive au Congo Belge 52,000 hectares de café. *Revue des questions scientifiques*, 1935, LIV:222-274.
- MAKKEFF, P. DE. Installations mécaniques pour le traitement du café. Bulletin Agricole du Congo Belge, 1931, XXI, 3:959-965.
- MANUEL pratique de la culture du caféier et du cacaoyer au Congo Belge. Ministère des colonies, *Bruxelles*, 1908. 96 pp.
- SLADDEN, G. E. L'Emploi des engrais verts et des plantes de couverture dans la culture du caféier. Bull. Agric., Belgian Congo, 1931, XXII:367-385.
- THEUNISSEN, R. Culture du caféier au Katanga. Bulletin Agricole du Congo Belge, 1931, XXI, 3:942-948.
- WATTEYNE, R. P. Le café du Kivu. Bulletin Agricole du Congo Belge, 1931, XXI, 3:939-941.

## BRAZIL

- BERTHOULE. La culture du caféier au Brésil, communication faite à la Société nationale d'acclimation de France. March 28, 1890.
- BRAZIL and coffee. Souvenir of the Louisiana purchase exposition. 1904. 28 pp.
- BRAZIL. A cultura do café. Monographia elaborada pelo serviço de inspeção e fomento agrícolas. *Rio de Janeiro*, 1929.
- CAFFÈ, IL: la coltivazione, la produzione, le imitazioni, le falsificazioni, il valore economico, il

P. Porto Alegre: "Monographia do Café"; 1879 Lisboa,

- fisiologico, appendice. *Rio Janeiro*, 1910. 98 pp.
- CRUWELL, G. A. and others. Brazil as a coffee-growing country. *Colombo*, 1878. 150 pp.
- DA COSTA SANTOS, H. Considerações sobre o nosso café. *Rio de Janeiro*, 1881. 19 pp.
- DAFERT, F. W. De bemesting en het drogen van kaffie in Brazilia. *Amsterdam*, 1898. 250 pp.
- Ueber die gegenwärtige Lage des Kaffeehaus in Brazilien. *Amsterdam*, 1898. Also in English, 1900; French, Paris, 1900.
- DAHNE, EUGENIO. The story of São Paulo coffee from plantation to cup. *The Tea and Coffee Trade Journal*, 1915, XXVIII:127.
- DANNERETH, FREDERIC. Research in Brazil leads to better coffee quality. (Converting hard into soft coffees through controlled fermentation.) *Spice Mill*, 1935, no. 6, LVIII:368 and 380.
- DE CAMARGO, ROGERIO. Cultura cafeeira. *São Paulo*, 1929.
- DE CASTRO, JOSÉ. Os cafés do Brasil. *Rio de Janeiro*, 1932.
- DE OLIVEIRA, LUIZ TORQUATO, Marques. Novo methodo da plantação fecundidade, durabilidade, estrumação e conservação do café e extinção das formigas, exposto em beneficio da agricultura do Brasil e lugares cafeeiros, oferecido aos agricultores. *Rio de Janeiro*, 1863. 30 pp.
- DE SAMPAIO FERREZ, J. O café os factores meteorológicos. *Rio de Janeiro*, 1928.
- EMPIRE of Brazil at the World's industrial and cotton centennial exposition of New Orleans, *The*. *New York*, 1885. 71 pp.
- HORN, E. F. Coffee production in Brazil today. *Tea and Coffee Trade Journal*, 1932, LXII:384-387.
- Some Brazil coffee-production problems. *Tea and Coffee Trade Journal*, 1932, LXII:584-589.
- JAMES, PRESTON E. The coffee lands of southeastern Brazil. *Geographical Review*, 1932, XXII:225-244.
- KOBEL, ROTHERY and TWENEY, editors. Enciclopedia de la America del sur. Agriculture, Brazil, v. I; São Paulo, v. IV. *London and Buenos Aires*, 1913.
- LALIERE, AMOUR. Le café dans l'état de Saint Paul (Brésil). *Paris*, 1909. 417 pp.
- MISSEN, LUIS and TÉLLEZ, O. Cultivo y beneficio del café en el Brazil: cómo se hacen en el estado de São Paulo. *México*, 1907. 30 pp.
- O FAZENDEIRO; revista mensal de agricultura, industria e commercio, dedicada, especialmente, aos interesses da lavoura cafeeira. Anno 1, *São Paulo*, 1908.
- PACHECO E SILVA, PERSIO. Do café no o este de S. Paulo. *São Paulo*, 1910. 64 pp.
- PECKHOLT, THEODORO. Monographia do café. In his, *Historia das plantas alimentares e de gozo do Brazil*. v. 5. 1871-84.
- SÃO PAULO, *Brazil*. Secretaria da agricultura, commercio e obras publicas. Il caffè. Brevi notizie per Eugenio Lefèvre. 1904. 68 pp.
- SCHUURMAN, G. A. E. De koffiecultuur in Brazilië. *Amsterdam*, 1901. 67 pp.
- SMITH, H. H. Brazil: Amazona and the coast. (Special chapters on coffee) *London*, 1880.
- Culture of Coffee in Brazil. *Scribner's Magazine*, XIX:225. *Penny Magazine*, IX:484.
- STORY of São Paulo coffee from plantation to cup. Pan American Union. Bulletin, 1915, XLI; 370-378.
- TEIXEIRA, C. O café do Brazil. *Rio de Janeiro*, 1883. 24 pp.

- UKERS, W. H. Among the coffee fazendas of Brazil. *Tea and Coffee Trade Journal*, 1934, no. 5, LXVII:414-427.
- WARD, R. D. Visit to the Brazilian coffee country. *National Geographic Magazine*, 1911, XXII: 908-931.

## CENTRAL AMERICA

- BIERBER, DR. Kaffeeanbau in Mittel- und Südamerika. *Das Hochland*, 1933, no. 1, IV:1-8.
- CATER, R. W. Coffee in Central America. *Chambers' Journal*, LXXVI:570.
- CHOUSSY, FELIX. Cultivo racional del café en centro América. *San Salvador*, 1917. 92 pp.
- FOX, ALVIN. Coffee growing in Central America. *Simmons' Spice Mill*, 1918, XLI:420-421.

## CEYLON

- ABBAY, R. Culture of coffee in Ceylon. *Households Words*, III:109. Also, *Nature*, XIV:375.
- CRUWELL, G. A. Liberian coffee in Ceylon. *Colombo*, 1878.
- HOLLAND, T. H. Revival of the Ceylon coffee industry. *Tea and Coffee Trade Journal*, Sept. 1932, LXIII:224-226.
- HULL, E. C. P. Coffee planting in southern India and Ceylon. *London*, 1877. 324 pp.
- KEEN, W. Coffee cultivation in Ceylon. *London*, 1871.
- LEWIS, G. C. Coffee planting in Ceylon. *Colombo*, 1855.
- SABONADIÈRE, WILLIAM. The coffee-planter of Ceylon. *London*, 1870. 216 pp.
- O fazendeiro de café em Ceylão. *Rio de Janeiro*, 1875, 196 pp.
- VAN SPALL, P. W. A. Verslag over de koffij en kaneelcultuur op het eiland Ceijlon. *Batavia*, 1863.

## COLOMBIA

- SAENZ, NICOLAS. Memoria sobre el cultivo del cafeto. *Bogota*, 1892. 65 pp. Also in French, *Bruxelles*, 1894. 121 pp.

## COSTA RICA

- CALVO, J. B. Coffee, its origin and propagation, its introduction and cultivation in Costa Rica. *American Republics Bureau. Monthly Bulletin*, 1904, XVIII:1-6; 111-115.
- Report on coffee with special reference to the Costa Rican product. *Bureau of American Republics. Publications. Washington*, 1901, 15 pp.
- COSTA RICA. Government. Estudio é informe sobre el café de Costa Rica. *San José*, 1900. 48 pp.
- FIELD, WALTER J. Coffee culture and preparation in Costa Rica. *The Tea and Coffee Trade Journal*, 1908, XV:13.
- SCHROEDER, JOHN. Coffee culture in Costa Rica. *San José*, 1890. 4 pp.

## CUBA

- BORRERO Y ECHEVERRÍA, ESTÉBAN. El café. Apuntes para una monografía. *Habana*, 1890. 46 pp.
- COFFEE grounds of Cuba. *All-the-Year*, XXIV:61.
- FERNÁNDEZ Y JIMÉNEZ, JOSÉ MARÍA. Agricultura cubana. 3 ed. *Habana*, 1868. 69 pp.
- FOX, ALVIN. Coffee culture in Cuba and Porto Rico. *Simmons' Spice Mill*, 1918, XLI:1356-1359.
- HILLMAN, JOSEPH. Coffee planting. *New York*, 1902. 16 pp.

- OLD Cuban coffee plantations. *Harper's Weekly*, 1908, LII:31.

## EAST INDIES

- ARNTZENIUS, G. Cultuur en volk. Beschouwingen over de gouvernementenskoffiecultuur op Java. 's *Gravenhage*, 1891. 158 pp.
- BALLY, M. W. Sur la culture comparative du caféier d'Arabie et du caféier Robusta à Java. *Revue de Botanique Appliquée et d'Agriculture Tropicale*, Aug. 1932:589-604.
- CAMPBELL, DONALD MACLAINE. The industries of Java: Coffee. In his, *Java: past and present. London*, 1915. pp. 931-944.
- CHALOT and THILLARD. Le café à Java. 1914.
- COFFEE enterprise in the East Indies. *Royal Botanic Gardens, Kew, Bull. of Misc. Information*, 1893:123-124.
- COLEMAN, L. C. Improvement of coffee in the Dutch East Indies. *Mysore State, Department of Agriculture*, 1931. Bulletin no. 15.
- CRAMER, P. J. S. Gegevens over de variabiliteit van de in Nederlandsch-Indië verbouwde koffiesoorten. *Batavia*, 1913. 696 pp.
- DUMONT, A. Consideraciones sobre el cultivo del café en esta isla. *Havana*, 1823.
- FERWERDA, F. P. Enten versus zaailingen bij koffie. *De Bergcultures*, 1932, no. 25, VI.
- HAGREIS, B. J. Manufacture of native-grown Robusta coffee in the West Coast of Sumatra. *Landbouw*, 1930, V:492-496.
- KEMPSKI, KARL EMIL. Die Kaffeekultur unter besonderer Berücksichtigung der Verhältnisse in Niederländisch-Indien. *Berlin*, 1924. 59 pp.
- KOFFIECULTUUR. *Tijdsch. voor Nederlandsch-Indië*, 1901, ser. 2, V:168-175.
- LEEUEW, HENRY DE. Coffees of Java and Dutch East Indies. *Tea and Coffee Trade Journal*, 1929, LVII:25-33.
- MARX, HERBERT. Der Kaffeeanbau auf Sumatra. *Langensalza*, 1931. 142 pp.
- NEDERLANDSCH-INDISCHE maatschappij van nijverheid en landbouw. Handleiding voor de gouvernementenskoffiecultuur. *Batavia*, 1873. 56 pp.
- PARKHURST, E. T. Y. Coffees of the Dutch East Indies. *The Tea and Coffee Trade Journal*, 1918, XXXV:316-322; 416-420; 1919, XXXVI: 22-27; 118-122.
- RAEDT VAN OLDENBAENEVELT, A. C. De koffiecultuur op Java. 's *Gravenhage*, 1898. 48 pp.
- SCHMEDES, W. Java Kaffee; einiges über den Kaffeebau in Niederländisch-Indien. *Bergstadt*, 1925, no. 3, XIII:607-615.
- SMID, J. H. Handboek voor de kultuur der koffie in Oost en West Indie. *Middelburg*, 1884.
- ULTEE, A. J. Coffee cultivation. *Malang*, 1929.
- VAN ERMEL, W. K. L. K. Some facts about coffee in Palembang. *Singapore*, 1879. 16 pp.
- VAN GORKOM, K. W. Groote cultuur in Nederlandsch Oostindie koffie. *Haarlem*. 1882.

## ECUADOR

- MARQUEZ, N. Préparation du café dans la République de l'Equateur. *Revista del Departamento de Agric. Republica del Ecuador*, 1933, I:8-43.

## ERITREA

- CHIAROMONTE, A. Aspetti entomologici della coltura del caffè nella Colonia Eritrea. *L'Agricoltura Coloniale, Istituto Agricolo Coloniale Italiano*, July 1933:320-323.

## FEDERATED MALAY STATES

- B.B. Modern coffee planting. The Malayan Agricultural Journal, Aug. 1934, p. 385.
- BUNTING, B. and MILSUM, J. N. Cultivation of coffee in Malaya. Malayan Agricultural Jour., 1930, XVIII:481-491.
- COFFEE. Department of Agriculture, S.S. and F.M.S. Leaflet no. 10.
- GALLAGHER, WILLIAM JOHN. Coffee robusta. *Kuala Lumpur, Federated Malay States*, 1910. 7 pp.
- LIBERIAN coffee at the Straits Settlements (C. Liberica bull.) Royal Botanic Gardens, *Kew*, Bull. of Misc. Information, 1888:261-263; 1890:107-108, 245-253.
- LIBERIAN coffee in the Malay native states. Royal Botanic Gardens, *Kew*, Bull. of Misc. Information, 1892:277-282.
- MILSUM, J. N. Liberian coffee in Malaya. The Malayan Agricultural Journal, 1931, XIX, 11.

## FRENCH INDO-CHINA

- BRIGGS, LAWRENCE P. The coffee of French Indo-China. Tea and Coffee Trade Journal, 1917, XXXIII:118-123.
- CHEVALIER, AUG. Le dépulpage et la dessiccation des cerises de café. Bulletin Economique de l'Indochine, March-April 1934:356-357.
- CRAMER, P. J. S. Coffee plantations of Tonkin, Philippine Agricultural Review, 1910, III:94-100.
- GULLAIS, R. Notes sur les conditions de la production du café au Phu-Qui. Bulletin Economique de l'Indochine, 1930, XXXIII:648B-652B.
- PARIS. Président du syndicat des productions et explorateurs de Tourane. Le café d'Annam; étude pratique sur sa culture. *Tourane, Annam*, 1895. 95 pp.
- PASQUIER, R. DU. Observations faites à la Station de Phu-Ho au cours de l'année 1931 (caféiers, théiers). Bulletin Economique de l'Indochine, Sept.-Oct. 1932:622-632.

## GOLD COAST

- COFFEE cultivation at the Gold Coast. Royal Botanic Gardens, *Kew*, Bull. of Misc. Information, 1895:21-23; 1897:325-328.
- WATERS, H. B. Yields of coffee on experiment stations, summarised to the end of 1927. Department of Agriculture, Gold Coast. Bulletin no. 16.

## GUADELOUPE

- BUFFON, A. La production du café a la Guadeloupe. *Revue Agricole, Service de la Guadeloupe et Dépendances*, Nov. 1933:308-310.
- COFFEE in Guadeloupe. The Tea and Coffee Trade Journal, 1912, XXIII:445.

## GUATEMALA

- DIESELDORF, E. P. Der Kaffeebaum. Praktische Erfahrungen über seine Behandlung im nördlichen Guatemala. *Berlin*, 1908. 36 pp.
- GUATEMALA coffee production and export. Tea and Coffee Trade Journal, 1934, LXVI:186-191.
- MORREN, F. W. Koffiecultuur in Guatemala, met aanteekeningen betreffende de overige cultuures de mijnen en den economischen toestand van deze republiek. *Amsterdam*, 1899. 142 pp.
- PARKHURST, E. T. Y. Coffee in Guatemala. *Californian Magazine*, II:742.

## GUIANA

- AUBLET, FUSÉE. Histoire des plantes de la Guyane française. Observations sur la culture du café. *Paris*, 1775.
- CLEARE, L. D. A preliminary survey of the coffee industry of the N. Western District. *Agr. Journ. Br. Guiana*, 1929, II:130-154.
- FERNANDES, D. S. Recherches sur la préparation du café "Liberia" en Suriname. Bulletin Agricole du Congo Belge, 1931, XXI, 3:934-938.
- GUIANA (British) Permanent exhibitions committee. Cacao and coffee industries. Leaflet 6. 1911. 12 pp.
- VAN HALL, C. J. J. De cultuur van Surinaamsche koffie. Berichten van de Afdeeling Handelsmuseum van de Kon. Vereeniging Koloniaal Instituut. *Amsterdam*, 1935, no. 81. 35 pp.

## HAWAII

- GREAT BRITAIN. FOREIGN OFFICE. Report on coffee culture in the Hawaiian Islands. *London*, 1897. 18 pp. (Diplomatic and Consular Reports. Miscellaneous Series, no. 425.)
- HAWAII. BOARD OF COMMISSIONERS OF AGRICULTURE AND FORESTRY. Culture of coffee. Hawaiian Forester and Agriculturist, 1911, VIII, no. 10. —Blight-resistant coffees. Hawaiian Forester and Agriculturist, 1912, IX, no. 3.
- HAYWOOD, WM. Coffee culture in the Hawaiian Islands. *Washington*, 1898. 164 pp.
- MCCHESENEY, J. M. The great coffee corner. Hawaiian Forester and Agriculturist, 1911, VIII:206-211.
- MCCLELLAND, J. L. Coffee culture in Hawaii. *Overland Monthly*, 1903, n.s. XLI:170-178.
- REPORT of the Hawaii Agricultural Experiment Station, 1932. Coffee, pp. 8-11.
- UNITED STATES DEPARTMENT OF AGRICULTURE. Division of Vegetable Physiology and Pathology. Circular No. 16. Danger of introducing a Central American coffee in Hawaii. *Washington*, 1898.
- WHITNEY, HENRY MARTYN. The Hawaiian coffee planter's manual. *Honolulu*, 1894. 48 pp.

## HAITI AND DOMINICAN REPUBLIC

- FAINE, JULES. Le café d'Haiti. *Revue Internationale des Produits Coloniaux*, 1934, IX: 216-222.
- INGINAC, G. B. Industrie agricole. Culture du caféier et préparation de la fève pour être livrée au commerce. *Port-au-Prince*, 1840. 22 pp.
- LABORIE, P. J. The coffee planter of Saint Domingo. *Colombo*, 1845. 204 pp. —An abridgement of the coffee planter of Saint Domingo. *Madras*, 1863. 83 pp.
- PRESTOE, H. Report on coffee cultivation in Dominica. *Trinidad*, 1875.

## HONDURAS, BRITISH

- COFFEE cultivation in British Honduras. Royal Botanic Gardens, *Kew*, Bull. of Misc. Information, 1892:253-259.
- REYES, FELIPE. Anotaciones sobre el cultivo del café. *Tegucigalpa*, 1927.

## INDIA

- ANSTEAD, R. D. Coffee, its cultivation and manuring in South India. *Bangalore*, 1915. 3 pp.

ANDERSON, G. Coffee culture in Mysore. *Bangalore*, 1879.

ARNOLD, E. L. On the Indian hills, or coffee planting in Southern India. *London*, 1895. 350 pp.

CULTIVATION of coffee in India. *Scientific American Supplement*, 1900, L:20620.

CULTURE of coffee in South Travancore. *Fraser's Magazine*, XC:64.

CURTLE, E. A. Coffee in South India. *The Malayan Agricultural Journal*, 1931, XIX, 7.

ELLIOTT, R. H. Planter in Mysore. *London*, 1871. —Gold, sport, and coffee planting in Mysore. *Westminster*, 1894. 480 pp.

EXPERIENCES of a coffee planter in Southern India. *Fraser's Magazine*, XVII:703.

COFFEE planting in Southern India. *Spectator*, LV:664.

HYBRID coffee in Mysore. *Royal Botanic Gardens, Kew, Bull. of Misc. Information*, 1898:30 and 207.

INDIA. STATISTICAL DEPARTMENT. The coffee crop in Coorg. *Simla*, 1885.

—The cultivation of coffee in India. *Simla*, 1898, 6 pp.

MAYNE, W. WILSON, NARASIMHAN, M. J., and SREENIVASAN, K. H. Spraying of coffee in South India. *Mysore Coffee Experimental Station*, 1933. Bulletin no. 9.

SANDERS, F. R. Coffee in South India. *Department of Agriculture, Tanganyika*, 1931. Pamphlet no. 4.

SHORTT, JOHN. A hand-book to coffee planting in southern India. *Madras*, 1864. 182 pp.

WATSON, J. D. Liberian coffee cultivation in Tavoy. *Tavoy, Burma*, 1893. 5 pp.

WINDLE, E. G. Modern coffee planting. *Madras*, 1933.

#### IVORY COAST

HEIM DE BALSAC, F. Etude technologique de cafés de la Côte-d'Ivoire. *Bulletin de l'Agence Générale des Colonies*, Oct. 1933:1236-1242.

LAPLACE, MICHEL. À propos du développement de la culture du caféier à la Côte l'Ivoire. *L'Agronomie Coloniale*, 1931, CLIX:69-72.

SIBERT, EDMOND. Les caféiers de la Côte-d'Ivoire. *Centre d'Etudes Coloniales, Paris*, 1932. 94 pp.

#### JAMAICA

LANSDALE, W. H. Coffee. *Jamaica in 1924*. pp. 167-168.

#### KENYA

BARGMAN, H. F. Kenya Colony and its coffee industry. *Nairobi*, 1931.

BECKLEY, V. A. Some factors in the manuring of coffee. *Department of Agriculture, Kenya*, 1932. Bulletin no. 16.

GILLET, S. Vegetative propagation. *Department of Agriculture, Kenya*, 1932. Bulletin no. 19.

SPROTT, F. H. Coffee planting in Kenya Colony. *Nairobi*, 1931.

TRENCH, A. D. Coffee seed selection. *Department of Agriculture, Kenya*, 1932. Bulletin no. 10.

—Green manure and cover crops. *Department of Agriculture, Kenya*, 1932. Bulletin no. 15.

—Premiliminary observations on coffee roots in Kenya. *Department of Agriculture, Kenya*, 1934. Bulletin no. 2.

—and GILLET, S. Coffee pruning. *Department of Agriculture, Kenya*, 1932. Bulletin no. 13.

#### LIBERIA

BOUTILLY, V. Le caféier de Libéria, sa culture et sa manipulation. *Paris*, 1900. 137 pp.

FELLE, W. Veeljarige waarnemingen en onder- vindingen van een Liberia-koffieplanter. 1894.

MORREN, F. W. Cultuur bereiding en handel van Liberia koffie. *Amsterdam*, 1894. 36 pp.

MORRIS, Sir DANIEL. Notes on Liberian coffee, its history and cultivation. *Jamaica*, 1881. 14 pp.

#### MADAGASCAR

BUIS, J. L'Hémileia et l'avenir du caféier à Mad- agascar, et à la Réunion. 1907.

CHOIX, M. Le café. *La Revue de Madagascar*, July, 1933:7-28.

FRANÇOIS, E. Les caféiers cultivés à Madagascar. *Bull. Econ.*, 1933, LXXXI:54-55.

—Les caféiers cultivés à Madagascar. *Bulletin Economique Mensuel*, May—August, 1933.

LEDREUX, A. La culture des caféiers à Madagas- car. *L'Agronomie Coloniale*, Jan., May, June, July, Aug., Sept., 1933.

RIGAUD, A. Traité pratique de la culture du café dans la région centrale de Madagascar. *Paris*, 1896. 102 pp.

#### MAURITIUS

COFFEE from Mauritius. *Bulletin Imperial Insti- tute*, 1928, XXVI:118-120.

#### MEXICO

COOK, J. D. American coffee culture in Mexico. *World Today*, 1907, XII:413-418.

FOX, ALVIN. Coffee culture in southern Mexico. *Simmons' Spice Mill*, 1918, XLI:1080-1081.

GÓMEZ, GABRIEL. Cultivo y beneficio del café. *Mexico*, 1894. 136 pp. Also in English.

LUDEWIG, H. JUAN. Veinte años trabajos de col- onización y el cultivo del cafeto en Soconusco. *Mexico*, 1909. 53 pp.

MONCADA, M. Notas sobre el cultivo y beneficio del café. *Memorias y revista de la Sociedad científica "Antonio Alzate"*, 1905-6, XXIII:281-287.

ROMERO, MATÍAS. Cultivo del café en la costa meridional de Chiapas. 3 ed. *Mexico*, 1875. 240 pp.

—El cultivo del café en la república mexicana. 2 ed. *Mexico*, 1893. 127 pp. Also in English, *New York*, 1901. 74 pp.

—El estado de Oaxaca. *Barcelona*, 1886. 212 pp.

TERRY, E. G. C. Near view of coffee in Mexico. *Pan American Union. Bulletin*. 1914, XXXIX: 903-906.

TERRY, L. M. Coffee culture in Mexico. *Overland Monthly*, 1901, n.s. XXXVII:702-709.

TORRES, J. T. Ensayo experimental sobre el café. *Mexico*, 1876.

YORBA, J. Mexican coffee culture. 2 ed. *Mexico*, 1895. 64 pp.

#### NATAL

NATAL. Commission appointed to inquire into and report upon matters relating to coffee cultiva- tion in the colony. *Report. Maritzburg*, 1881. 6 pp.

STAINBANK, H. E. Coffee in Natal; its culture; and preparation. *London*, 1874. 78 pp.

#### NEW CALEDONIA

CAMOUILLY. La plantation du café en Nouvelle- Calédonia. *Paris*, 1899.

- CHEVALIER, AUG. La culture du caféier en Nouvelle Calédonie. *Revue de Botanique Appliquée et d'Agriculture Tropicale*, 1931, 115:174-176.
- RISBEC, J. Le café en Nouvelle Calédonie. *L'Agronomie Coloniale*, 1930, CLIV:97-104; CLV:136-147.
- NEW GUINEA
- MURRAY, G. H. Coffee cultivation. Department of Agriculture, New Guinea, 1931. Leaflet no. 66.
- NICARAGUA
- RIVAS, DEOGRACIAS. Metodo para sembrar el café nacional borbón salvadoreño. *Managua*, 1927.
- SHEDD, W. J. The story of Matagalpa coffee. *Tea and Coffee Trade Journal*, 1918, XXXIV:118-122.
- PARAGUAY
- COFFEE growing in Paraguay. *Scientific American Supplement*, 1914, LXXVIII:340.
- PHILIPPINE ISLANDS
- BAGALSO, CLARO C. Top working old coffee trees which are poor yielders. *The Philippine Agriculturist*, Dec., 1932:491-504.
- GALANG, F. G. Coffee culture. *Philippine Agricultural Review*, 1928, XXI:345-397.
- LUISTRO, F. D. The effect of mulching on the yield of Excelsa coffee: A progress report for 1930-33. *Philippine Journal of Agriculture*, 1934, V:17-19.
- MENDIOLA, N. B. The Kawisari B. coffee introduced in the College of Agriculture. *The Philippine Agriculturist*, 1931, XX, 2:101-111.
- PUERTO RICO
- LINCK, J. H. Arbor caffè Lipsiae florens. *Extrait factice des Ephem. Acad. naturae curiosorum*. 1725. 7 pp.
- MCCLELLAND, THOMAS B. Suggestions on coffee planting for Porto Rico. Porto Rico Agricultural Experiment Station. Circular, no. 15. Also in Spanish.
- MCCLELLAND, T. B. Restoring Porto Rico coffee. *The Tea and Coffee Trade Journal*, 1918, XXXV:420-421.
- Coffee varieties in Porto Rico. Porto Rico Agricultural Experiment Station, 1924. Bulletin no. 30.
- NATIONAL COFFEE GROWERS' ASSOCIATION. Some facts about Porto Rico coffee. 1913.
- VAN LEENHOFF, JOHANNES W. Coffee planting in Porto Rico. *Mayaguez*, 1904. 14 pp.
- PORTUGUESE COLONIES
- SOCIEDADE DE GEOGRAPHIADE LISBOA. Exposição colonial de algodão, borracha, cacau e café. 1906. 104 pp.
- RHODESIA
- MARSHALL, G. W. Coffee growing in Southern Rhodesia. *Rhodesia Agricultural Journal*, 1927, XXIV:835-846.
- SIERRA LEONE
- HIGHLAND coffee of Sierra Leone (*Coffea stenophylla*, C. Don.) Royal Botanic Gardens, *Kew*, Bull. of Misc. Information, 1896:189-191.
- SCOTLAND, D. W. Hints on the cultivation and preparation of coffee in Sierra Leone. Dept. of Lands and Forests, 1923. Pamphlet no. XI.
- SOUTH AMERICA
- BIERBER, DR. Kaffeeanbau in Mittel- und Südamerika. *Das Hochland*, 1933, no. 1, IV:1-8.
- FOX, ALVIN. Liberian coffee in South America. *Simmons' Spice Mill*, 1918, XLI:549-550.
- TANGANYIKA
- SANDERS, F. R. and WAKEFIELD, A. J. Coffee cultivation with special reference to the Northern Province. Department of Agriculture, *Tanganyika*, 1932. Bulletin no. 7.
- Further observations on factors in Arabian coffee culture. Department of Agriculture, *Tanganyika*, 1932. Bulletin no. 8.
- TRINIDAD
- RAPSEY, H. Coffee in Trinidad. *Proc. Agr. Soc. Trinidad and Tobago*, 1932, XXXII:207-211.
- TRINIDAD coffee. Royal Botanic Gardens, *Kew*, Bull. of Misc. Information, 1888:129-133.
- UGANDA
- BROWN, E. and HUNTER, H. H. Planting in Uganda; coffee, Para rubber, cocoa. *London*, 1913. 176 pp.
- COFFEE and tea from Uganda. Imperial Institute. Bulletin. *London*, 1918, XVI.
- MATLAND, T. D. The cultivation of *Coffea robusta*. Department of Agriculture, Uganda, 1926. Bulletin no. 15.
- SMALL, W. Coffee cultivation in Uganda. Imperial Institute. Bulletin. 1914, XII:242-250.
- UNITED STATES
- JONES, A. C. *Thea viridis*, or Chinese tea plant, and the practicability of its culture and manufacture in the United States. Also some remarks on the cultivation of the coffee plant. *Washington*, 1877. 26 pp.
- KAINS, M. G. Chicory growing as an addition to the resources of the American farmer. U. S. Dept. of Agriculture. Div. of Botany. Bulletin, no. 19. *Washington*, 1898.
- VENEZUELA
- ERNST, A. El café de Liberia en Vénézuéla. *Caracas*, 1878.
- HUNTINGTON, L. M. The story of Táchira coffee. *Tea and Coffee Trade Journal*, 1917, XXXIII:318-325.
- JUNTA de aclimatacion cuestionario sobre el cultivo del café. *Caracas*, 1895. 42 pp.
- PELACIOS, G. DELGADO. Contribución al estudio del café en Venezuela. *Caracas*, 1895. 93 pp.
- WEST INDIES
- KERVEGANT, D. Le caféier à la Martinique. Bulletin de l'Agence Générale des Colonies, Nov., 1932, pp. 1653-1686.
- LOWNDES, JOHN. The coffee-planter; or, An essay on the cultivation and manufacturing of that article of West-India produce. *London*, 1807. 76 pp.
- NICHOLLS, H. A. A. Liberian coffee in the West Indies. *London*, 1881. 31 pp.



## SOILS

- CLARKE, T. On the management of soils, under coffee in Madras. Madras Agricultural Exhibit. Report. 1883.
- FAUCHERE, A. Du choix du terrain dans la culture du caféier. Colonie de Madagascar and Dependances. Bulletin économique, 1907, VII: 349-353.
- FRTZ, A. Concentration en ions H de terres à caféiers. L'Agronomie Coloniale, Nov., 1933: 141-143.
- GRACIE, DAVID S. Soil condition affecting coffee in Kenya. Bulletin Department of Agriculture, 1931, VII:1-45.
- HUGHES, J. Ceylon coffee soils and manures. London, 1879.
- JONES, G. H. GETHIN. Coffee soils of Kenya and their cultivation. Department of Agriculture, Kenya, 1932. Bulletin no. 21.
- KENNY, J. Tea, coffee, tobacco (manuring, etc.) 1910.
- KRAMERS, J. G. Verslag omtrent grondanalyses van koffietuinen. Batavia, 1902. 86 pp.

## DISEASES AND ENEMIES

- AULMANN, G and LA BAUME, M. Die Faune der deutscher Kolonien. Pt. 2. Die Schädlinge des Kaffees. Berlin, 1911.
- BALLY, W. Handboek voor de koffiecultuur: eerste deel, de ziekten van de koffie. Amsterdam, 1931.
- BURCK, W. Over de oorzaken van den achteruitgang van de gouvernementkoffiecultuur op Java. 1896.
- Over de koffiëbladziekte en de middelen om haar te bestrijden. Batavia, 1887:61.
- BIDIE, G. Report on the ravages of the bore in coffee estates. Madras, 1869. 93 pp.
- BOSSE, J. VON. Eenige beschouwingen omtrent de oorzaken van den achteruitgang van de koffiecultuur der Sumatra's Westkust, etc. 's Gravenhage, 1895.
- CAMERON, JOHN. Prevention of leaf disease in coffee; report of a visit to Coorg. 1899. 23 pp.
- COOKE, M. C. Two coffee diseases. Popular Science Review, XV:161.
- DELACROIX, GEORGES. Les maladies et les ennemis des caféiers. Paris, 1900. 212 pp.
- ERNST, ADOLF. Estudios sobre las deformaciones, enfermedades y enemigos del árbol de café en Venezuela. Caracas, 1878. 21 pp.
- GOELDI, EMIL AUGUST. Memoria sobre una enfermedad del café en la provincia Rio de Janeiro, Brasil. Mexico, 1894. 118 pp.
- GREEN, E. E. Observations on the green scale bug in connection with the cultivation of coffee. Colombo, 1886. 4 pp.
- HARMAN, F. E. Report on coffee leaf miner disease. Mysore Government. Bangalore, 1880. 41 pp.
- INDIA. MYSORE. DEPARTMENT OF AGRICULTURE. Short report of a tour made in Coorg during February and March, 1914. (Green bug on coffee.) 1914. 3 pp.
- KONINGSBERGER, J. C. De dierlijke vijanden der koffiecultuur op Java. Batavia, 1897-1901. 2 pts.
- KUYPER, J. Een fusicladium-ziekte op hevea. De zilver-draad-ziekte der koffie in Suriname. De gevolgen van keukenzout-houdend water voor begieting en bespuiting. 1913.
- LEMARIÉ, CHARLES. Une maladie du caféier. Hanoi, 1899. 6 pp.
- MASSE, G. E. Coffee diseases of the New World, Royal Botanic Gardens, Kew, Bull. of Misc. Information, 1909:337-341.
- MEXICO. MINISTERIO DE FOMENTO, COLONIZACIÓN E INDUSTRIA. La fumagina y el pulgón de los cafetos en la República Mexicana. 1897. 11 pp.
- MISSON, LUIS and TÉLLEZ, O. Cultivo y beneficio del café en el Brasil: como se hacen en el estado de São Paulo, por Luis Misson; y Plagas del café en México, por O. Téllez. Mexico, 1907. 30 pp. (Mexico, 1867-republic. Comisión de Parasitología Agrícola. Circular 70.)
- NEITNER, J. The coffee tree and its enemies in Ceylon. Colombo, 1880. 32 pp.
- PEELEN, H. J. E. Eenige opmerkingen omtrent de koffiëbladziekte. 1888.
- PRINS, H. J. De oeret-plaag in de koffietuinen op Java. 1884.
- SADEBECK, R. Beobachtungen und Bemerkungen über die durch Hemileia vastatrix verursachte Blattfleckenkrankheiten der Kaffeebäume. München, 1895. 9 pp.
- SMITH, JARED G. Two plant diseases in Hawaii. Honolulu, 1904. 6 pp.
- THIERRY, A. J. Notes sur le greffage du caféier, du cacaoier et du muscadier et la maladie vermiculaire du caféier. 1899. 77 pp. Reprinted from Bulletin agricole de la Martinique.
- TINS, H. J. De veret-plaag in de koffietuinen op Java. Enschede, 1885. 86 pp.
- TONDUZ, ADOLFO. Informe sobre la enfermedad del café. San José (Costa Rica), 1893. 28 pp.
- VAN ROMUNDE, R. Koffiëbladziekte en koffie cultuur. 's Gravenhage, 1892. 92 pp.
- ZACHER, FRIEDRICH. Die wichtigsten Krankheiten und Schädlinge der tropischen Kulturpflanzen und ihre Bekämpfung. Hamburg, 1914.
- ZIMMERMANN, ALBRECHT. De nematoden der koffiewortels. Batavia, 1898-1900. 2v.

## Periodicals

- ARNDT, C. H. and DOZIER, H. L. The Haitian coffee tree cricket. Journal Department of Agriculture. Puerto Rico, 1931, XV:325-335.
- BALLY, W. and REYDON, G. A. Etat actuel de la question des maladies des nématodes du caféier. Archief voor Koffiecultuur in Ned-Indie, 1931, no. 2:23-216.
- BECKLEY, V. A. The Yellowing of coffee. Department of Agriculture, Kenya, 1931. Bulletin 3.
- BOTANICAL MAGAZINE, London, 1787-1904. Coffee arabica, XXXII, tab. 1303; CXXII, tab. 7475; coffee benghalensis, LXXXII, tab. 4917; coffee stenophylla, CXXII, tab. 7475; coffee travacarenensis, coffee triflora, CX, tab. 6749.
- BOURIQUET, G. Les maladies du caféier à Madagascar. L'Agronomie Coloniale, 1934; Jan., pp. 1-10; Feb., pp. 42-48; March, pp. 73-82.
- COLEMAN, L. C. Report on the coffee berry borer in Java. Mysore State, Department of Agriculture, 1931. Bulletin 16.
- COOK, MELVILLE THURSTON. The coffee leaf miner. U. S. Dept. of Agriculture. Bureau of Entomology. Bulletin, 1905, n. s. LII:97-99.
- COOK, M. T. and HORNE, W. T. Coffee leaf miner and other coffee pests. Santiago, 1905. 21 pp. (Cuba, 1902-republic. Estación central agrónomica. Boletín 3. English and Spanish ed.)

- FABER, F. C. VON. Die Krankheiten und Schädlinge des Kaffees. *Centralblatt für Bakteriologie, Abteilung 2.* 1908, XXI:97-117.
- FAWCETT, GEORGE L. Fungus diseases of coffee in Porto Rico. *Porto Rico Agricultural Experiment Station. Bulletin 17.*
- FRAPPA, CL. Les insectes nuisibles au caféier à Madagascar. *Bulletin Economique Mensuel*, 1933, Sept., pp. 73-79; Oct., pp. 66-71; 1934, March, pp. 296-305.
- GIARD, A. Sur deux cochenilles nouvelles *Orthiziola fodiens* nov. spec. et *Rhizococcus Eloti* nov. spec., parasites des racines du caféier à la Guadeloupe. *Comptes rendus de la Société de Biologie*, 1897.
- GÖLDIE, E. A. Relatorio sobre a molestia do caféiro na provincia do Rio de Janeiro. *Archivos do Museu Nacional do Rio de Janeiro*, 1892, VIII:7-121.
- HARGREAVES, H. Variegated coffee bug (*Antestia* spp.). *Department of Agriculture, Uganda. Bulletin 22.*
- JAMES, H. C. The control of *Asterolecanium*. *Department of Agriculture, Kenya, 1932. Bulletin 23.*
- Banding for coffee mealy bug control. *Department of Agriculture, Kenya, 1932. Bulletin 24.*
- KADEN, O. Das Kaffeesterben in Angola, eine physiologische Welkekrankheit. *Der TROPENPflanzer*, April, 1933:139-146.
- LE PELLEY, R. H. On the control of *Antestia lineaticollis*, Stal., on coffee in Kenya Colony. *Bull. Entom. Res.*, 1932, XXIII:217-228.
- Field spraying with undiluted paraffin extracts of *Pyrethrum* against *Antestia* and *Lygus* on coffees in Kenya. *Bull. Entom. Res.*, 1933, XXIV:1-32.
- Report on questionnaire on *Antestia* control, 1933-34. *Department of Agriculture, Kenya, 1934. Bulletin 5.*
- LEEFMANS, SALOMON. De koffiebessenboeboek (*Stephanoderes hampei* Ferrari—*coffea* Hagedorn). *Mededeelingen van de afdeling voor plantenziekten. No. 57*, 62.
- MCDONALD, J. H. The major coffee diseases. *Department of Agriculture, Kenya, 1932, Bulletin 20.*
- MALLAMAIRE, A. Les borers du caféier en Basse Côte-d'Ivoire. *Bulletin du Comité d'Etudes Historiques et Scientifiques de l'Afrique Occidentale Française*, Apr.-Sept., 1932:425-455.
- MANN, B. P. Coffee leaf miner. *American Naturalist*, VI:332-596.
- MARCHAL, PAUL. Sur un nouvel ennemi du caféier; le "*Xyleborus coffeae*." *Journal d'Agriculture tropicale*, 1909, IX:227-228.
- MAYNE, W. W. Seasonal periodicity of coffee leaf disease. *Mysore State, Department of Agriculture, 1930 and 1931. Bulletins 4 and 6.*
- Recent work on coffee leaf diseases. *Planters' Chronicle*, 1932, no. 10, XXVII:253-257.
- MORRIS, D. Coffee-leaf disease of Ceylon. *Nature*, XX:557.
- MORSTATT, HERMANN ALBERT. Die Schädlinge und Krankheiten des Kaffeebaumes in Ostafrika. *Zeitschrift für Land- und Forstwirtschaft in Deutsch-Ostafrika*, 1912, VIII, Juli.
- PASQUIER, R. DU. Principales maladies parasitaires du théier et du caféier en Extrême-Orient. *Bulletin Economique de l'Indochine*, May-June, July-Aug., Nov.-Dec., 1932; Jan.-Feb.-March-Apr., 1933.
- PICADO, C. Fusarium disease of coffee in Costa Rica. *Journal of the Department of Agriculture, 1932, XVI:389-400.*
- REPORT on the disease situation in coffee areas in 1933. *Mysore Coffee Experimental Station, 1934. Bulletin 1.*
- SLADDEN, G. E. Le *Stephanoderes Hampei* Ferr. *Bulletin of Agriculture, Belgian Congo, 1934, XXV:26-77.*
- STAHEL, GEROLD. Zur Kenntnis der Siebröhrenkrankheit (Phloemnekrose) des Kaffeebaumes in Surinam. *Phytopathologische Zeitschrift*, Berlin, 1931, IV, no. 1.
- De tegenwoordige stand van het onderzoek naar den overdrager der zeeftatenziekte van de koffie. *Mededeeling, Department Landbouwproefstation Suriname, 1934, no. 7.*
- STOREY, H. H. A bark disease of coffee in East Africa. *Annals of Applied Biology*, 1932, XIX, no. 2.
- SUBRAMANIAM, T. V. The coffee stem borer (*Xylotrechus quadripes*, Chev.). *Department of Agriculture, Mysore. Bulletin 11.*
- TEA and coffee diseases. *Royal gardens, Kew. Bulletin, 1899, CLI-CLII:89-133.*
- TUCKER, ELBERT STEPHEN. Some miscellaneous results of the work of the Bureau of Entomology—IX. New breeding records of the coffee-bean weevil. *U. S. Dept. of Agriculture Bureau of Entomology. Bulletin, 1909, LXIV:61-64.*
- VAN DER WEELE, H. W. Ein neuer javanischer kaffeeschädling. *Xyleborus coffeivorus* nov. spec. *East Indies, Dutch. Department van Landbouw. Bulletin, 1910, XXXV. Zoologie 5. pp. 1-6.*
- WALLACE, G. B. Coffee root diseases and their control. *Planter, E. Africa, 1932, no. 3, I:11-13.*
- WILKINSON, H. B. Report of committee on coffee berry disease. *Department of Agriculture, Kenya, 1934. Bulletin 3. 20 pp.*
- The coffee bug (*Antestia lineaticollis*). *Department of Agriculture, Uganda. Bulletin 13.*
- ZIMMERMANN, ALBRECHT. De kanker (Rostelaziekte) van *Coffea arabica*. *Buitenzorg, Java. Jardin botanique. Mededeelingen uit 's Lands plantentuin, 1900, XXXVII:24-62.*

## GENERAL WORKS

## DESCRIPTIVE, HISTORICAL, ETC.

- ABBAL, L. Étude sur le café. *Montpellier*, 1885.
- ABENDROTH, G. F. De coffea. *Lipsiae*, 1825.
- ALCOTT, WILLIAM ALEXANDER. Tea and coffee. *Boston*, 1839. 174 pp.
- ALVES DE LIMA, J. C. Some revelations about the cultivation, the commerce and the use of coffee. *Syracuse, N. Y.*, 1901, 16 pp.
- BLOUNT (BLUNT), SIR HENRY. An epistle in praise of tobacco and coffee, prefixed to a little treatise entitled *Organum Salutis*. *London*, 1657.
- BONTEKOE, C. Tractaat van het excellente kruid thee. I. Van de coffi. 's *Gravenhage*, 1679.
- BRILL, MARBUGER. Dissertation sur le café. 1862.
- BUC'HOZ, P. J. Dissertation sur le café. *Paris*, 1787.
- CHENEY, RALPH HOLT. Coffee, a monograph of the economic species of the Genus *Coffea* L. *New York*, 1925.
- CHEVALLIER, ALPHONSE. Du café, son historique, son usage, son utilité, ses altérations, ses succédanés et ses falsifications, etc. *Paris*, 1862.

- CHOUSSY, FELIX. El café. *San Salvador*, 1934.
- COFFEE: Report of the Imperial Economic Committee. *London*, 1931.
- COMMEMORAÇÃO do II centenario do cafeeiro no Brasil, Articles by Lyra Castro, Georgius Aug. Paddrg-Drenkpol et al. Museu Nacional do Rio de Janeiro Boletim. *Rio de Janeiro*, 1927.
- CORNAILLAC, G. El café, la vainilla, el cacao y el té, cultivo, preparación, exportación, clasificación comercial, gastos, rendimiento. *Barcelona*, 1903. 480 pp.
- COUBARD D'AULNAY, G. E. Monographie du café, ou manuel de l'amateur du café, ouvrage contenant la description et la culture du caféier, l'histoire du café, ses caractères commerciaux, sa préparation et ses propriétés. *Paris*, 1832.
- CRIPET, DR. Histoire et physiologie du café. *Paris*, 1846.
- DELRUE-SCHREVEN, L. Le café: étude historique et commerciale. *Tournai*, 1886. 90 pp.
- DE VAUX, ANTOINE ALEXIS FRANÇOIS, CADET. Dissertation sur le café; son historique, ses propriétés, et le procédé pour en obtenir la boisson la plus agréable, etc. *Paris*, 1807. 119 pp.
- DOUGLAS, JAMES. Arbor yemensis fructum coffee ferens: or, A description and history of the coffee tree. *London*, 1727. 60 pp.
- DUCHARTRE, P. Plantes alimentaires. De l'usage du café, du thé, et du chocolat. *Paris*, 1865.
- DUFOUR, PHILIPPE S. Traitez nouveaux et curieux du café, du thé, et du chocolat. *Lyons*, 1671, 1684; *La Haye*, 1693.
- DUMAS, LEON. Le pays du café. 1885.
- EGGERTH, J. De coffea. *Budae*, 1833.
- ELLIS, JOHN. An historical account of coffee. *London*, 1774. 71 pp.
- ETRENNES à tous les amateurs de café; contenant l'histoire, la description, la culture, les propriétés de ce végétal. *Paris*, 1790. 2 pts. in 1 v.
- FAUCHON, L. J. Sur le café, *Paris*, 1815.
- FOOT, FREDERICK N. Coffee, the beverage. *New York*, 1925.
- FRANKLIN, ALFRED. La vie privée d'autrefois. *Paris*, 1893.
- GALLAND, A. De l'origine et du progrès du café. Sur un manuscrit arabe de la Bibliothèque du Roy. *Paris*, 1699.
- GALLAND, ANTOINE. A treatise upon the origin of coffee. *London*, 1695.
- GENTIL, M. Dissertation sur le café. 1787. 180 pp.
- GEORGIUS, J. C. S. De coffea. *Tubingæ*, 1752.
- GIRARD, A. L. Les sucres, le café, le thé, le chocolat. *Paris*, 1907. 96 pp.
- GMELIN, JOHN GEORGE. Dissertation de coffea. *Tubingæ*, 1752.
- GRAY, ARTHUR, comp. Over the black coffee. *New York*, 1902. 108 pp.
- GUBIAN, J. M. A. Sur le café. *Paris*, 1814.
- GUILLOT, A. Le café. *Toulon*, 1883.
- HEWITT, ROBERT, JR. Coffee: its history, cultivation, and uses. *New York*, 1872. 102 pp.
- HOUGHTON, JOHN. Account of coffee. 1699.
- HULL, E. C. P. Coffee, its physiology, history and cultivation. *Madras*, 1865.
- INSTITUT INTERNATIONAL D'AGRICULTURE, Rome. Le café en 1931 et 1932. 232 pp.
- JACOB, HEINRICH EDUARD. Sage und Siegeszug des Kaffees. *Berlin*, 1934; Coffee, The Epic of a Commodity, *New York*, 1935.
- JAMES, ROBERT. Treatise on tobacco, tea, coffee and chocolate. *London*, 1745.
- JARDIN, EDÉLESTAN.\* Le caféier et le café, monographie historique, scientifique et commerciale de cette rubiacée. *Paris*, 1895. 413 pp.
- JOMAND, J. Du café. *Paris*, 1860.
- JONASSON, OLOF. Kaffet och kaffelanderna. *Stockholm*, 1932.
- KEABLE, B. B. Coffee from grower to consumer. *London*, 1910 and 1933.
- KOEBEL, ROTHERY AND TWENEY, editors. Enciclopedia de la America del Sur. Coffee in South America, v. II:14. *London and Buenos Aires*, 1913.
- KRAMERS, J. G. Waarnemingen en beschouwingen naar aanleiding van eene reis in de koffie. *Batavia*, 1898. 101 pp.
- KRUGER, JOHN G. Gedanken, vom Kaffee, Thee und Taback. 1743.
- LABAT, LE P. Traité de la culture du café, dans un nouveau voyage aux îles de l'Amérique. *Paris*, 1722.
- LALOU. Du café: son origine, le temps de sa découverte et celui où l'on commence à en faire usage. *Rouen*, 1843.
- LAW, W. The history of coffee, including a chapter on chicory. *London*, 1850.
- LE PLE, A. Le café: histoire, science, hygiène. *Rouen*, 1877. 38 pp.
- LOCK, CHARLES GEORGE WARNFORD. Coffee: its culture and commerce in all countries. *London*, 1888. 264 pp.
- LODGE, J. L. Coffee. *Birmingham*, 1894. 14 pp.
- MAATSCHAPPIJ tot nut van't algemeen. Bijdragen tot de kennis van de voornaamste voortbrengselen van Nederlandsch Indie. *Amsterdam*, 1860-61. 2 v. II. De koffij.
- MACDOUGALL, MRS. ALICE FOOTE. Coffee and waffles. *New York*, 1927.
- MACÉ, C. Du café. *Paris*, 1853.
- MARCUS, C. J. De coffea. *Leipzig*, 1837.
- MARTÍNEZ, EMILIANO. Memoria sobre el café; su cultivo, beneficio, maquinas en uso, escojida, exigencias de los mercados, y otros conocimientos utiles. 2 ed. *Nueva Orleans*, 1887. 61 pp.
- MEYNER. Traité sur le café. 1624.
- MIEDAN, C. Du café. *Paris*, 1862.
- MINAS GERAES. Minas e o bicentenario do cafeeiro no Brasil 1727-1927. Contribuição da Secretaria da agricultura do estado de Minas Geraes. *Bello Horizonte*, 1929.
- MOREIRA, N. J. Breve considerações sobre historia e cultura do café e consumo de seus productos. *Rio de Janeiro*, 1873.
- MULLER, EDGAR. Arabiens Vermächtnis; Tatsachen und Dokumente über den Kaffee aus Ernährungswissenschaft und Rechtsprechung. *Hamburg*, 1931.
- NAIRON, ANTOINE FAUSTUS. De saluberrima potione cahue, seu cafe nuncupata discursus. *Romae*, 1671.
- A discourse on coffee; its description and virtues. (Tr. from Latin by C. B.) *London*, 1710.
- NATIONAL FEDERATION OF COFFEE GROWERS OF COLOMBIA. The land of coffee. *New York*, 1932.
- NATUR gemässige Beschreibung der Coffee, etc. *Hamburg*, 1684.
- NEUMANN, ERNEST. Der kaffee: seine geographische verbreitung, gesamtproduktion und konsumtion. *Berlin*, 1932.
- NIEBUHR, KARSTENS. Description de l'Arabie. *Amsterdam*, 1774.

\* Not Édelestan as elsewhere in the volume.

- Travels through Arabia performed. *London*, 1792.
- NEUBERT, J. Der Kaffee. *Würzburg*, 1838.
- NOBTZ & COMPANY. Facts about coffee and sugar. *New York*, 1924.
- NOVI tractatus de potu caphé; de chinensium thé; et de chocolata. *Geneva*, 1699.
- OLDMIXON, JOHN. Het Britannische ryk in Amerika, zynde eene beschryving van de ontdekking, bevolking, inwoonders, het klimaat, den koophandel, en tegenwoordigen staat van alle de Britannische coloniën, in dat gedeelte der wereldt. Uit het Engelsch, als mede een omstandig Berecht aangaande de koffy en koffy-plantery uit het Fransch vertaald. *Amsterdam*, 1721. 2 v.
- PAN AMERICAN UNION. Coffee. *Washington*, D. C. 1901.
- PAULL, S. A treatise on tobacco, tea, coffee and chocolate. (tr. by Dr. James) *London*, 1746.
- PENILLEAU, AUGUSTE. Étude sur le café, au point de vue historique, physiologique, hygiénique et alimentaire. *Paris*, 1864. 90 pp.
- PENNETIER, G. Le café. *Paris*, 1878.
- PETERS, F. De potu caff. *Giessæ Hassorum*, 1666.
- PRESCOTT, SAMUEL C. Report of an investigation of coffee. *New York*, 1927.
- PRINGLE, W. Science and coffee. *Madras*, 1897. 66 pp.
- QUÉLUS, DE. Histoire naturelle du cacao, et du café, etc. *Amsterdam*, 1720.
- RAMOS, AUGUSTO. O café. *Rio de Janeiro*, 1923.
- RAMSEY (RUMSEY), WALTER. Organum salutis; or experiments on the virtue of coffee and tobacco. *London*, 1657.
- RAOUL, EDOUARD FRANÇOIS ARMAND. Culture du caféier, semis, plantations, taille, cueillette, de pulpatation, décorticage, expédition, commerce, espèces et races. 2 ed. *Paris*, 1897. 251 pp.
- REICHENBACH, ANTON BENEDICT. Der Kaffeebaum, seine Verbreitung, Kulturgeschichte und natürliche Beschaffenheit, der Kaffeehandel und die Consumption des Kaffee's, seine medicinische Anwendung, die Kaffeesurrogate und der Anbau der gangbarsten Sorten. *Berlin*, 1867. 92 pp.
- RENDLE, A. B. and FREEMAN, W. G. Encyclopædia Britannica. 11th ed. v.6:646
- ROBIN, L. Memoire sur le café, sur sa culture, son commerce, ses propriétés physiologiques, thérapeutiques et alimentaires. *Abbeville*, 1864.
- ROQUES, JOSEPH. Traité historique de l'origine et de progres du café, tant dans l'Europe, de son introduction en France et de l'établissement de son usage à Paris. *Paris*, 1715.
- RUMFORD, Count (BENJAMIN THOMPSON). Of the excellent qualities of coffee, and the art of making it in the highest perfection. Essay XVIII. pp. 155-207.
- SPLITZERBER. Drey Tractate von Café, Thé und Chocolate. *Budissin*, 1688.
- SPON, J. De l'usage du caphé, du thé, et du chocolat. *Paris*, 1671.
- TARR, A. De coffea. *Pestini*, 1836. Hungarian text.
- THOMPSON, BENJAMIN. (See RUMFORD, Count.)
- THOMPSON, WILLIAM GILMAN. Coffee. Composition; method of preparation; physiological action; adulteration; substitutes. In his, Practical dietetics, 1909. pp. 252-257.
- THURBER, FRANCIS BEATTY. Coffee: from plantation to cup. *New York*, 1881. 416 pp.
- TOGNI, M. Raccolta delle singolari qualità del caffè. *Venetia*, 1675.
- UKERS, WILLIAM H. Coffee Merchandising. *New York*, 1924 and 1930.
- A trip to Brazil. *New York*, 1935.
- VAN DEN BERG, NOBERT PIETER. Historical-statistical notes on the production and consumption of coffee. *Batavia*, 1880. 92 pp.
- VILARDEBO, J. El tabaco y el café. *Barcelona*, 1888. 142 pp.
- VILLACORTA, PEDRO A. Platica científica sobre el café de El Salvador. *San Salvador*, Oct., 1931.
- WALSH, JOSEPH M. Coffee: its history, classification and description. *Philadelphia*, 1894. 309 pp.
- WELTER, H. Essai sur l'histoire du café. *Paris*, 1868.
- YOUNG, ISABEL N. The story of coffee. Bureau of Coffee Information, *New York*, 1931. Bulletin 1.
- YOUNG, ISABEL N. Coffee facts for homemakers. Bureau of Coffee Information. *New York*, 1931. Bulletin 2.
- ZIMMERMANN, D. ALBRECHT. Kaffee. *Hamburg*, 1926.

## Periodicals

- AHLENIUS, KARL. Kaffe, te och rörsocker, deras ursprungliga hem och viktigaste produktionsråden. *Ymer*, 1903, XXIII:242-268.
- BANNISTER, RICHARD. Sugar, coffee, tea and cocoa, their origin, preparation, and uses. *Journal of the Society of Arts*, XXXVIII:1000-1014.
- BRANSON, W. P. Coffee. *Journal of the Society of Arts*, 1874, XXII:456-461.
- COFFEE. *Leisure Hour*, 1882, XXXI:45-48.
- COFFEE King. *Chambers' Journal*, LXXXII:23.
- COFFEE infusion. *Medical Standard*, 1913, XXXVI:52-56.
- DE JUSSIEU. Histoire du café. *Histoire de l'Académie Royal des Sciences*, 1713; *Mémoires*, 1716; 291.
- DEWEY, STODDARD. How coffee came to Paris. *English Illustrated Magazine*, 1898, XX:312-315.
- FERRIS, W. M. Coffee. *Nation*, XXXIV:192; *Leisure Hour*, XXXI:45.
- FRANÇOIS, EDM. Les cafés a l'Exposition Coloniale Internationale de 1931. *Revue de Botanique Appliquée et d'Agriculture Tropicale*, May, 1932:341-347.
- GUÉRIN, P. Le café. *Revue Scientifique*, 1908, ser. 5. X:486-494.
- HAMLIN, W. A. The world's coffee cup. *Duns International Review*, 1923: 35-38.
- HARRIS, WILLIAM B. Some coffees of today. *Good Housekeeping*, 1913, LVII:264-268.
- HERAUD, AUG. FRED. Le café. *Science et Nature*, Feb. 28, 1885, p. 209.
- HISTORY and cultivation of coffee. *Godey's Lady's Book*, LIV:51.
- HOFFMAN, PAUL. Aus dem ersten Jahrhundert des Kaffees. *Zeitschrift für Kulturgeschichte*, 1901, VIII:405-441, IX:90-104.
- JACKSON, J. R. Coffee. *Nature*, 11:126; *Blackwells' Magazine*, LXXV:86; *Household Words*, V:562; *Penny Magazine*, 1:49.
- LESSON, RENÉ-PRIMEVÈRE. Précis historique, botanique, médical et agronomique sur le café. *Annual Mar. et Col.*, 1820:842.
- MARSHALL, W. B. Coffee, its history and commerce; an outline. *American Journal of Pharmacy*, 1902, LXXIV:361-374.
- OM Kaffe, dess historica och användning. *Helsovännan*, 1887, II:157-163.

- PICTORIAL History of coffee. The Tea and Coffee Trade Journal, 1918, XXXIV:26-28; 124-127; XXXV:116-125; 526-534; 1919, XXXVI:322-324; 515-516; XXXVII:140-145.
- TUCKERMANN, C. K. Coffee drinking in eastern Europe. North American Review, 1889, CXLVIII:643-645.
- UKERS, WILLIAM H. Better teas and coffees. Good Housekeeping, 1911, LIII:495-498. Reprinted, Tea and Coffee Trade Journal, 1911, XXI:274-276.
- A talk on coffee. Good Housekeeping, 1908, XLVI:532-536.
- Tea and coffee economies. Joe Chapple's News Letter, 1913, I:9. Reprinted, Tea and Coffee Trade Journal, 1913, XXV:476-477.
- The leading coffee cities of Brazil. Tea and Coffee Trade Journal, 1934, no. 4, LXVII:314-329.
- WORLD'S drink. Review of Reviews, 1909, XXXIX:109-110.
- LITERATURE, POETRY, ROMANCE
- ABD-EL-KADIR, ANSARI DJEZERI HANABALI. Des preuves les plus fortes en faveur de la légitimité de l'usage du café, in chréostomathie arabe, par Sylvestre de Sacy. Paris, 1806.
- BAROTTI, L. Il caffè (poem). Esprit des Journaux, 1681, 110-120.
- BLONDEAU. Étrennes littéraires aux grands hommes ou l'empire du café, poème en 10 chants. Paris, date unknown.
- L'empire du café et le rapport de son influence sur l'esprit les mœurs et l'économie animale, poème en 4 chants. Paris, 1824.
- BOUQUET blanc et le bouquet noir, Le, poisie en 4 chants. 60 pp.
- BRADY, CYRUS TOWNSEND. A corner in coffee. New York, 1904.
- CAFFEE die schonste Panacee, in einem Lobgedicht über die wunder bare Heilkraft des nectarischen Caffee-tranks. 1775. 23 pp.
- CHARACTER of a coffee house, with the symptoms of a town-wit. London, 1673; in Harleian Miscellany, VI:429.
- CHARACTER of coffee and coffee houses. Hazlitt's Handbook to Popular Literature, 1661.
- COFFEE and crumpets; a poem. Frasers' Magazine, XV:316.
- COFFEE houses vindicated: in answer to the late published character of a coffee house. London, 1675; also in Harleian Miscellany, VI:433.
- COFFEE scuffle; occasioned by a contest between a learned knight and a pitifull pedagogue, with the character of a coffee house. Printed and are to be sold at the Salmon coffee house, near the stocks market, (London), 1662. Verses by Woolnoth or Sir J. Langham and Evans, a school-master.
- DE GOURCUFF, O. Le café, epître attribué à Senecé, Nantes, 1883. 19 pp.
- DE MEY, C. Le café poème: accompagné de documents historiques sur le café, sur son origine, sur son commerce et sur les peuples d'Orient qui font spécialement usage du café. Rennes, 1837. 204 pp.
- D'ISRAËLI, ISAAC. Curiosities of literature. London, 1824. Contains article on, Introduction of tea, coffee and chocolate in which the following items are mentioned: (1) An Arabic and English pamphlet on The nature of the drink, kouhi or coffee, pub. at Oxford, 1569; (2) A cup of coffee, or coffee in its colours, a satirical poem (quoted), 1663; (3) A broadside against coffee or the marriage of the Turk (quoted), 1672; (4) The women's petition against coffee, 1674.
- DRUMONT, E. Les cafés et les restaurants d'autrefois. Magasin Littéraire, X:264.
- EXCELLENT virtue of that sober drink coffee, The. Popular ballad of the 17th century. Broadsheet.
- GEYER, E. E. An potus café dicti vestigia in Hebraeos sacrae scripturae codice reperiantur? Dissertation. Wittenbergiae, 1740.
- GOLDONI, CARLO. La bottega di caffè. Venice, 1750.
- The coffee house. A comedy in three acts. Translated by Henry B. Fuller, New York, 1925.
- HENRICI, CHRISTIAN FRIEDRICH. Coffee and cupid. Operetta in one act by Johann Sebastian Bach. London, 1925.
- LAGUERRE, J. N. Essai sur le café. Paris, 1818.
- LEJAY, CHARLES. Toutes les révélations par le marc de café. Paris, 1930. 61 pp.
- LE PAGE, AUG. Les cafés politiques et littéraires de Paris. 1874.
- MASSIEU, G. Carmen caffaeum. Paris, 1740.
- MELAYE, S. Éloge du café. (A song.) Paris, 1852. 4 pp.
- MILLER, JAMES. The coffee-house. A dramatick piece. London, 1737. 38 pp.
- POEM in Latin, A, on coffee; is found in the Abbé Olivier's, Collection of modern Latin poets; and in, Etrennes à tous les amateurs du café, Paris, 1790, in which a French translation is printed facing the Latin text; also Il caffè, in Poemetti Italiana, vol. 3, 1797.
- REBELLIOUS antidote: or a dialogue between coffee and tea: verse, 1685.
- ROSSEAU, J. B. Le caffè, comédie. 1695. 56 pp.
- SCHOTEL, G. D. J. Letterkundige bijdragen tot de geschiedenis van den tabak, de koffij en de thee. 's Gravenhage, 1848. 215 pp.
- ST. SERFE, THOMAS. Taruga's wiles, or the coffee house; a comedy. London, 1668.
- SMYTH, PHILIP. The coffee house; a characteristic poem. London, 1795.
- SPIGHER, DOROTHY GLADYS. The song of the coffee bird. New York, 1932.
- STEELE, SIR RICHARD. On characters in coffee houses. Spectator, No. 49.
- VOLTAIRE, F. M. A. DE. The coffee-house; or, Fair fugitive. A comedy. London, 1760.
- WARD, EDWARD. The humours of a coffee house. London, 1714.
- MANUFACTURING PROCESSES
- BREWING
- ABORN, EDWARD. Better coffee making. Tea and Coffee Trade Journal, 1912, Supplement to No. 6, XXIII:49-52; 1913, XXV:568-574; 1919, XXIX:553-556.
- Better coffee for the army. The Tea and Coffee Trade Journal, 1918, XXXV:622-624.
- On boiling coffee. The Tea and Coffee Trade Journal, 1919, XXXVI:48-49.
- Coffee-making developments. Tea and Coffee Trade Journal, 1914, XXVII:550-556.
- On coffee grinding and brewing. Yesterday, today and tomorrow in better coffee making. Tea and Coffee Trade Journal, 1916, XXXI:570-576.
- BACON, RAYMOND F. Efficiency of coffee-making devices. Tea and Coffee Trade Journal, 1915, XXIX:427-429.
- BEST method of making coffee. Journal of Home Economics, 1914, VI:480-481.



- BONNETTE. Préparation du café en campagne, filtre "en rognon" adapté à une marmite de campement. *Revue d'Hygiène*, 1911, XXXIII: 459-462. Also, in Spanish, *Revista de Sanidad militar*, 1911, ser. 3, I:427-429.
- BOYES, E. How to obtain an ideal cup of coffee; its cost and value. *London*, 1898. 16 pp.
- BROADBENT, HUMPHREY. The domestick coffee man, shewing the true way of preparing and making chocolate, coffee and tea. *London*, 1722.
- COFFEE making questionnaire. *The Tea and Coffee Trade Journal*, 1917, XXXII:31-34.
- DUFOUR, PHILIPPE SYLVESTRE. Translation by John Chamberlayne. The manner of making coffee, tea, and chocolate. As it is used in most parts of Europe, Asia, Africa and Spanish America. Newly done out of French and Spanish. *London*, 1685. 116 pp.
- ELLIS, H. D. Notes on the earliest form of coffee-pot. *Proceedings of the Society of Antiquaries of London*, 1899, ser. 2, XVII:390-394.
- FOREST, L. L'art de faire le café du cuit à l'ancienne. *Paris*.
- FRANK, M. G. The correctness of grind in relation to coffee brewing. *Associated Coffee Industries of America*, *New York*, 1933.
- FRANKEL, E. M. Coffee making comparisons. *Tea and Coffee Trade Journal*, 1917, XXXII:336-337.
- FRANKEL, F. HULTON. Value of coffee brews. *Tea and Coffee Trade Journal*, 1917, XXXIII:238.
- GENTIL, A. A. P. Dissertation sur le café et sur les moyens propres à prévenir les effets qui résultent de sa préparation, communément vicieuse, et en rendre la boisson plus agreable et plus salubre. *Paris*, 1797.
- GIRAUD, A. Cafés de Paris, procédés uniques pour la préparation du café, glorias, grogs à l'américaine. *Paris*, 1853. 75 pp.
- HARRIS, William B. Coffee making comparisons. *Tea and Coffee Trade Journal*, 1917, XXXII: 336-337.
- How to make a cup of coffee. *Godey's Lady's Book*. LXIII:107. Also, *Sharpe's London Magazine*, XLIV:259.
- LILLENFELD-TOAL, O. A. VON. Probleme der Kaffee-aufbereitung in Brasilien. *Tropenpflanzer*, 1932, XXXV:315-332.
- MAASSEN, CARL GEORG VON. Rund um die Kaffeekanne. *Munich*, 1930.
- MASSON, Abbé. Le café, ses propriétés, manière nouvelles de la préparer. *Epernay*, 1885. 24 pp.
- MASSON, P. Le parfait limonadier, ou la manière de préparer le thé, le café, chocolat. *Paris*, 1705.
- MEITZKY, J. H. De vario coffeæ potum parandi modo. *Wittebergia*, 1782.
- PUNNETT, P. W. The brewing often depends upon the pot. *Food Industries*, Oct. 1933, V:405-407.
- RECTOR, GEORGE. Draw one in the dark. *The Saturday Evening Post*, May 12, 1934:14, 96-102.
- T., C. DE. Café français: recette économique. *Paris*, 1824.
- WILHELM, R. C. "Drip" method the best. *Tea and Coffee Trade Journal*, 1916, XXXI:338-339.
- WILCOX, O. W. About coffee-making methods. *Tea and Coffee Trade Journal*, 1913, XXV:618-620.
- WOODRUFF, SYBIL. Standard strength in coffee brews. *Tea and Coffee Trade Journal*, 1916, XXXI:133-137.
- WORLD'S largest coffee brewery. *The Tea and Coffee Trade Journal*, 1919, XXXVI:230-233.

## GLAZING

- DANNEMILLER, A. J. Coffee coating upheld. *Tea and Coffee Trade Journal*, 1914, XXVII:556-557.
- HARRIS, WILLIAM B. Green and roast coffees, the adulteration and misbranding thereof. *American Grocer*, Nov. 19, 1913:19-20.
- KRZYZAN, R. Ueber Eiweiss-Kaffeeglasur. *Zeitschrift für Nahrungs- und Genussmittel*, 1906, XII:213-216.
- SCHAEER, E. Notizen über die Firnisierung von Kaffeebohnen, *Zeitschrift für Untersuchung der Nahrungs- und Genussmittel*, 1906, XII:60.
- WILCOX, O. W. Concerning glazed coffees. *Tea and Coffee Trade Journal*, 1914, XXVI:340-341.

## MISCELLANEOUS

- CULTURED coffee activities. *The Tea and Coffee Trade Journal*, 1921, XLI:456-458.
- FLAKED coffee—strained foods—cane sugar. *Canadian Chemistry and Metallurgy*, April 1934:81.
- GIRAUD, A. Le café perfectionné. *Paris*, 1846.
- HARRIS, WILLIAM B. Making coffee for the consumer. *Tea and Coffee Trade Journal*, 1914, XXVI:335-338.
- How soluble coffee is made. *The Tea and Coffee Trade Journal*, 1921, XLI:162-166.
- LIQUID coffee. *Tea and Coffee Trade Journal*, May-Sept., 1931.
- PREPARATION of coffee for use. *Penny Magazine*, III:228.
- PUNNETT, P. W. and BALART, B. D. Can a "gas" be pulled from coffee. *Tea and Coffee Trade Journal*, 1934, LXVII:428; 430.
- WALKER, J. Handbook of coffee pulpers and pulping. *Kandy, Ceylon*, 1894. 36 pp.

## MODIFICATIONS, CAFFEINE-FREE, ETC.

- DANIELS, CLINTON K. Daniels' golden coffee. 1882, 3 pp.
- DETOXICATION of coffee. *Scientific American*, Mar. 27, 1915, CXII:292.
- NON-TOXIC coffee and tea. *Scientific American*, Nov. 13, 1909, CI:346.
- WIMMER, K. Caffeineless coffee. *Scientific American*, Apr. 11, 1908, XCVIII:258.

## POLISHING AND COLOPING

- HALLEUX, EDMOND. Le commerce des cafés avariés colorés ou enrobés. *Annales des Falsifications*, 1909, II, no. 7:201-206.
- MORPURGO, G. Notizie sulla colorazione artificiale del caffè e sui mezzi scoprirla. *Orosi*, 1897, XX:397-403.
- RAUMER, E. VON. Ueber den Nachweis künstlicher Färbungen bei Rohkaffee. *Forschungs-Berichte über Lebensmittel*, 1896. III:333-338.
- SAUVAGE, EDOUARD. Note sur les cafés verts lustrés-colorés. Leur rôle commercial. *Annales des Falsifications*, 1910, III:113-117.

## ROASTING AND GRINDING

- ACH, F. J. Roasting costs and accounting. *The Tea and Coffee Trade Journal*, 1912, XXIII: 133.

- BRAND, CARL W. Increased packing costs. *The Tea and Coffee Trade Journal*, 1916, XXXI:567-570.
- BURNS, A. LINCOLN. Factory efficiency. *The Tea and Coffee Trade Journal*, 1912, XXIII:30-33.
- DAUSSE. Manuel de l'amateur du café, ou l'art de torréfier les cafés convenablement, basé sur l'analyse chimique. *Paris*, 1846.
- ELECTRIC coffee roasting in Germany. *Electrical World*, 1906, XLVIII:117-178.
- EVOLUTION of the coffee roaster. *Tea and Coffee Trade Journal*, 1910, XVIII:390-392.
- GILLIES, EDWIN J. Getting a roasting profit. *The Tea and Coffee Trade Journal*, 1912, XXIII:65-68.
- HOLSTAD, S. H. Keeping tab on costs. *The Tea and Coffee Trade Journal*, 1912, XXIII:68-70.
- KING, JOHN E. Grinding and packing coffee. *The Tea and Coffee Trade Journal*, 1917, XXXIII:552-555.
- KNOWLTON, H. S. Power installation of a coffee-roasting and spice-grinding plant. *Electrical World*, 1905, XLV:678-681.
- MCGARTY, M. J. Scientific coffee roasting. *The Tea and Coffee Trade Journal*, 1916, XXXI:336-337.
- PUNNETT, P. W. Advantages of the all-purpose grind. *Tea and Coffee Trade Journal*, 1934, LXVII:338-340.
- TURCQ DES ROSIERS, LE. Le café: une révolution dans ses procédés de torréfaction. *Paris*, 1890.
- WILHELM, R. C. The color of the roast. *The Tea and Coffee Trade Journal*, 1916, XXXI:428-429.
- WRIGHT, GEORGE S. Automatic weighing tests. *The Tea and Coffee Trade Journal*, 1915, XXIX:568-570.
- ZINSMEISTER, LEE G. Roasting economies. *Tea and Coffee Trade Journal*, 1914, XXVII:558-561; 1915, XXIX:545-550.
- MEDICINAL QUALITIES AND USES  
AS ANTISEPTIC AND DISINFECTANT
- BARBIER. Le café comme désinfectant. *Journal de Médecine et Pharmacie de l'Algérie*, 1881, VI:315-318.
- CRANE, W. H. and FRIEDLÄNDER, A. The antiseptic qualities of coffee. *American Medicine*, 1903, VI:403-407.
- HEIM, L. Ueber den antiseptischen Werth des gerösteten Kaffees. *Münchener medicinische Wochenschrift*, 1886, XXXIV:293-312.
- OPPLER. Der Kaffee als Antisepticum. *Deutsche militärärztliche Zeitschrift*, 1885, XIV:567-577.

## GENERAL

- AIGNANT OU AIGNAN. Le preste médecin, avec un traité du thé, du café, en France. *Paris*, 1606.
- B., W. Coffee, its origin, properties and virtues. *London*, 1908.
- BLEGNY, N. DE. Le bon usage du thé, café et du chocolat pour la prévention et la guérison des maladies. *Paris*, 1687. \*Lyon, th. Lemaire
- BONTEKOË, CORNEILLE. Le thé, le café, et le chocolat. 1699.
- BRADLEY, RICHARD. The virtue and use of coffee, with regard to the plague, and other infectious distempers. *London*, 1721. 34 pp.
- BRILLIÉ, L. and DUPRÉ, E. Etude sur les cafés. Communication a la Société française d'hygiène. *Paris*, 1889.
- CHICOU, T. Du café en hygiène et en thérapeutique. *Paris*, 1859.
- DAUPLEY, C. E. Etude sur le café; ses applications à la médecine. *Paris*, 1867.
- ELOY, NICHOLAS F. J. Question medico-politique, si l'usage de café est avantageux à la santé, et s'il peut se concilier avec le bien de l'état dans les provinces belgique. 1781.
- FONTAINE. Hernie traité par l'infusion de café. *Paris*, 1865.
- LANDARRILCO, OSMIN. Nouvelles propriétés thérapeutiques du café vert dans les affections du foie, les coliques hépatiques et le diabète. *Montpellier*, 1888.
- LECONTE, A. H. Emploi du café thérapeutique. *Strasbourg*, 1859.
- MAGGI, D. Virtù del Kafe, bevanda introdotta nuovamente nell'Italia. 2 ed. *Roma*, 1671, 16 pp.
- MARVAUD, ANGEL. Les boissons aromatiques. Le café. In his, Les aliments d'épargne, *Paris*, 1874. 2 pt., pp. 292-320.
- MUNDAY (MUNDY), HENRY. Opera omnia—Physica de aere vitali, esculentis, et potutentis, cum appendice de pasergris in victu et chocolatu, thea, coffea, tobaco. *Leyden*, 1685.
- PETTIT, H. De la prolongation de la vie humaine par le café. 2 éd. *Paris*, 1862.
- RICHE, CH. Les poisons de l'intelligence, l'alcool, le chloroforme, le haschich, l'opium, le café. *Paris*, 1877.
- TRIFFET, A. Du café, de ses effets sur l'homme. *Paris*, 1847.
- UKERS, WILLIAM H. The healthfulness of coffee. *New York*, 1929.
- VILLEMUS, A. Du café et le ses principales applications thérapeutiques. *Paris*, 1875.
- VIREY, J. J. Nouvelles considérations sur l'histoire et les effets hygiéniques du cafés et sur le genre coffea. *Paris*, 1816.
- WEISS, C. C. Coffee arabica nach seiner zerstörenden Wirkung auf animalische Dünste als Schutzmittel gegen Contagion vorschlagen. *Friberg*, 1832.

## Periodicals

- ALLEGED medicinal properties of the husk of the coffee bean, *The Lancet*, 1902, II:944.
- BALZAC. Traité des excitants modernes. Alcool, sucre, thé café, tabac. Extrait fact. de la Revue de Paris. 1852.
- BENEFICIAL effects of coffee as a drink. Review of *Reviews*, 1906, XXXIII:245-246.
- BOLTENSTERN, VON. Zur Bewerkung des Kaffees als Volksgenussmittel. *Deutsche Arzte-Zeitung*, 1905, 457-461.
- CARON, D. A. Coffee and milk as a diet. *Journal of Franklin Institute*, LXIV:349.
- DALSON, A. T. and WETHERILL, C. M. Coffee as a beverage. *Journal of Franklin Inst.* LX:60-111.
- DOMBROVSKI, I. F. Kofe i yevo liechebniya svoista. (Coffee and its medical properties.) *Vrachebnaya Gazeta*, 1901, VIII:733-736.
- DUJARDIN-BEAUMETZ. On new cardiac medicaments. *Therapeutic Gazette*, 1884, n. s. V:444-449.
- DUSART, O. Étude critique sur l'action physiologique et thérapeutique des médicaments dits antidépenseurs: café, coca, etc. *Tribune médicale*, 1874, VII:197-200.
- ENGLISH, W. Reply to objections against the use of tea and coffee. *Lancet*, 1833-4, II:75.
- GOLINER. Ueber unschädlichen Kaffeegenuss. *Frauenarzt*, 1906, XXI:205.

- GRISWOLD, E. H. Coffee, its uses and medical qualities. *Southern Practitioner*, 1882, IV:269.
- HAMILTON, W. On the medical properties of the coffee arabica. *Pharmaceutical Journal*, 1851, X:450-454.
- HOLLAND, J. W. Coffee as a preventive for malarial diseases. *Louisville Medical News*, 1876, I:63-65.
- HORNEMANN, E. Kaffe-Sporgsmaalet. (Hygienic value of coffee.) *Hygieniske Meddelelser, Kjøbenhavn*, 1864. IV:pt. 3, 286-310.
- IRVIN, ROBERT ROY. Hygienic aspects of coffee. *Medical Journal and Record*, Oct. 5, 19 and Nov. 2, 1927.
- MEDICINAL properties of the husk of the coffee bean. *Scientific American Supplement*, Mar. 7, 1903, LV:22-123.
- ON the medical properties of coffee arabica. *Pharmaceutical Journal*, X:450-454.
- PAUL, J. On coffee, its medical, disinfecting, and dietetic properties. *New Jersey Medical Reporter*, 1851-2, V:265, 297.
- ROQUES, J. Note sur les propriétés médicales du café. *Bulletin général de Thérapeutique*, 1835, VIII:289-294.
- "S. CULAPIUS." The healthfulness of coffee. *Tea and Coffee Trade Journal*, 1913, XXV:27-28, 129-130, 239-240, 345-346, 449-450; 1914, XXVI:137-138.
- SQUIBB. Tea and coffee as therapeutic substitutes for coca and guarana. *Ephemeris of Materia Medica*, 1884, II:637-647.
- STUTZER, A. Neues über die Wirkung der daraus hergestellten Getränke in gesundheitlicher Beziehung. *Centralblatt für allgemeine Gesundheitspflege*, 1892, XI:145-151.
- WEITENWEBER, W. R. Diätetischmedizinische Würdigung des Caffees. *Oesterreichische medicinische Wochenschrift*, 1845, pp. 1551, 1583.
- Therapeutische Abhandlung über den Caffee. *Medicinische Jahrbücher des kaiserl. königl. österreichischen Staates*. 1846. LVIII:1, 139.
- PHYSIOLOGICAL EFFECTS
- GENERAL USE AND MISUSE, COFFEE-HABIT, ETC.
- ALCOTT, WILLIAM ALEXANDER. Tea and coffee: their physical, intellectual, and moral effects on the human system. Rev. ed. *Manchester*, 1877. 31 pp. Also in German, *Berlin*, 1869.
- BOEHMER, G. R. Pr. inessentiae coffeae in novellis publicis nuper commendatae virtutem inquiritt. *Wittebergae*, 1782.
- BOMBY, R. Le caféisme. *Paris*, 1905.
- BONA, G. DALLA. Dell' uso e dell' abuso del caffè, dissertazione storico-fisico-medica. *Verona*, 1751.
- BOUGARDE, E. Du caféisme; contribution à une étude synthétique. *Paris*, 1899.
- BRAEUNINGER, J. M. De potus caffè usu et abusu. *Erfordiaae*, 1725.
- BRUGHMAN, FRANCIS ERNEST. A treatise on coffee and a condemnation of its use. *Brunswick*, 1727.
- BUC'HOZ, P. J. Dissertation sur l'utilité et les bons et mauvaises effets du tabac, du café, du cacao et du thé. *Paris*, 1775.
- CALKINS, A. Opium and opium appetite, with notices of alcoholic beverages, Cannabis indica, tobacco and cocoa, and tea and coffee, in their hygienic aspects and pathologic relations. *New York*, 1871.
- CALVERT, ESPRIT. An potus café quotidianus val-etudini tuendæ vitæ que producendæ noxius? *Avenione*, 1762.
- CAMERARIUS, E. Dissertationes tres, exhibentes... III. Usum et abusum potum, "Thee," et "Caffe" in his regionibus. *Tubingae*, 1694.
- CATHOMAS, J. B. Ist der Kaffee und Teegenuss gesundheitsschädlich? *St. Gallen*, 1910.
- CROTHERS, T. D. (Effects of the coffee habit.) In his, *Morphinism and narcomanias from other drugs*. 1902, pp. 303-305.
- DAVIER DE BREVILLE, J. P. An a frequentiori potu café vita brevior? *Paris*, 1715.
- DEBAY, A. Les influences du chocolat, du thé et du café sur l'économie humaine. *Paris*, 1864.
- DE JUSSIEU, JOSEPH. Litteratis ne salubris coffeae usus. *Paris*, 1741.
- DELTEL, É. Du café, de ses effets physiologiques, et de son emploi en thérapeutique. *Paris*, 1851.
- DUNCAN, DANIEL. Wholesome advice against the abuse of hot liquors, particularly coffee, tea, chocolate, brandy and strong waters. *London*, 1706.
- GARNIER, A. Inaestio medica . discutienda in Scholis Medicarum Joanne-Francisco Couthier, Praeside: An parisinio frequento potus thé, frequenti potu caffè salubrior? *Paris*, 1749. 4 pp.
- GAYANT, L. An a frequentiori potu café vita brevior? *Paris*, 1715.
- GERMANY. KAISERLICHES GESUNDHEITSAMT. Der Kaffee; gemeinfassliche Darstellung der Gewinnung, Verwertung und Beurteilung des Kaffees und seiner Ersatzstoffe. *Berlin*, 1903. 174 pp.
- GLEDITSCH, J. G. De potus cofe abusu catalogum morborum augente. *Lipsiae*, 1744.
- GRIMMANN, J. N. De coffee potus usu noxio. 1730.
- GÜNTHER, LEO. Der Caffee als Hausgetränk. Eine Warnung. *Leipzig*, 1907.
- HAHNEMAN, S. A treatise on the effects of coffee. *Louisville*, 1875.
- HANDBOOK of the medical sciences. Article on coffee, v. III:p. 190.
- HILSCHERUS, S. P. Pr. . de abusu potus coffeae in sexu sequiori. *Jena*, 1727.
- HUSS, M. Om kaffe, dess bruk och missbruk; en folkskrift. *Stockholm*, 1865.
- HUSSON, C. Le café, la bière et le tabac. Étude physiologique et chimique. *Paris*, 1879. 206 pp.
- KLAMANN, CARL, publisher. Der Kaffee in seiner heutigen Bedeutung als Nahrungs- und Genussmittel. *Hamburg*, 1882. 48 pp.
- KNOLL, J. C. G. Lettre à un ami sur les opérations du café. *Quedlinbourg*, 1752.
- LAVEDAN, ANTONIO. Tratado de los usos, abusos propiedades y virtudes del tabaco, café, té y chocolate. *Madrid*, 1796. 237 pp.
- LEMARE-PIQUET, DE HONFLEUR. Etudes expérimentales de médecin, contenant des observations sur l'action dynamique du café. *Paris*, 1864.
- LINNE, CARL VON. Dissertatio medica, in qua potus coffeae, leviter adumbratur. *Upsaliae*, 1761. 18 pp.
- LORAND, ARNOLD. Coffee. In his, *Health through rational diet*. *Philadelphia*, 1913. pp. 309-313. Excerpts reprinted in *Tea and Coffee Trade Journal*, 1913, XXIV:24-26.
- On other stimulants—tea, coffee, cocoa, tobacco: their merits and disadvantages. In his, *Old age deferred*, *Philadelphia*, 1910: pp. 362-367. Excerpts reprinted in *Tea and Coffee Trade Journal*, 1911, XX:188-190.
- MAPPUS, M. De potu caffè. *Argentorati*, 1693.

- MARCHAND, N. L. Recherches organographiques et organogéniques sur le coffea arabica. L. Paris, 1864. 48 pp.
- MASSON, V. P. De l'usage et de l'abus du thé et du café. Paris, 1848.
- MEDICUS, G. F. Anacrisis medico-historico-diaetetica de caffè et chocalate, etc., 1720.
- MEISNER, L. F. De caffè . anacrisis medico-historico-diaetetica. Norimbergae, 1721.
- MÉPLAIN, F. Du café. Étude de thérapeutique physiologique. Paris, 1868.
- MICHAELIS, A. De koffie (Coffea arabica) als genoten geneesmiddel, naar hare botanische, dieëtetische en geneeskrachtige eigenschappen. Amsterdam, 1894.
- MOSELEY, B. M. A treatise concerning the properties and effects of coffee. London, 1785. 69 pp.
- OMOUT, R. Contribution à l'étude du caféisme. Montpellier, 1904.
- OTTLIEBEN, F. B. De potus ex coffeae seminibus parati noxio effectu. Helmstadii, 1870.
- PLAZ, A. G. De potus coffe abusu catalogum morborum augente. Lipsiae, 1763. Also, in his, De jucundis morborum causis, Lipsiae, 1754. pp. 20-54.
- POORE, G. V. Coffee and tea. London, 1883. 44 pp.
- PROZOROVSKI, I. D. Vliyanie kofe i niekotorikh yevov surrogatov na bolieznnetvornnye nizshie organizmi. (The effect of coffee and of some of its substitutes upon pathogenic organisms.) St. Petersburg, 1895.
- RAMBALDI, A. Ambrosia arabica, ovvero della salutare bevanda café. Bologna, 1691.
- RIANT, AIMÉ. Le café, le chocolat, le thé. Paris, 1875. 160 pp.
- ROCHE, A. Du café noir et de la caféine au point de vue de l'action physiologique et des applications à l'hygiène. Montpellier, 1873.
- SARATHEZ, H. Étude physiologique du café. Paris, 1870.
- SAINT-ARROMAN, A. De l'action du café, du thé, et du chocolat sur la santé, et de leur influence sur l'intelligence et le moral de l'homme. Bruvelles. 1845. Also in English, Philadelphia, 1846. 90 pp.
- SALLEBY, C. W. Tea, coffee, cocoa and tobacco. In his, Health, strength and happiness, New York, 1908. pp. 190-203. Reprinted in, Tea and Coffee Trade Journal, 1908, XV:299-301.
- Worry, drugs and drink. In his, Worry: the disease of the age, New York, 1907. pp. 93-110. Excerpts reprinted in Tea and Coffee Trade Journal, 1911, XX:190-192.
- SAMUEL, H. De usu et abusu potus coffee. Duisburgh ad Rhenum, 1747.
- SCHWARZKOPF, S. A. Der Kaffee in Naturhistorischer diaetetischer und medicinischer Hinsicht, seine Bestandtheile, Anwendung, Wirkung und Geschichte. Weimer, 1831.
- SILVESTRI, DOMENICO. Dissertazione chimico-medica sul caffè. Genova, 1815.
- SINCLAIR, W. J. Beverages: tea, coffee, etc. (Health lectures.) Manchester, 1881.
- SMITH, HUGH. An essay on the nerves to which is added an essay on foreign teas, with observations on mineral waters, coffee, and chocolate, etc. London, 1794.
- SPARSCHUCH, H. Potus coffeae leviter adumbratur. Upsaliae, 1761.
- TRÉFET, H. A. Histoire et physiologie du café. De son action sur l'homme à l'état de santé et à l'état de maladie. Paris, 1864.
- VAN DER TRAPPEN, J. E. Specimen historico-medicum de Coffea, etc. Trajecti ad Rhenum, 1843. 152 pp.
- WEIDENBUSCH, N. De noxis ex abusu potus caffè in corpore humano. Moguntiae, 1769.
- WEIGL, J. Der Kaffeegenuss, eine Schädigung der Leistungsfähigkeit. München, 1904.
- Kaffeetrinken und Gesundheit, 2 ed. München, 1904.
- WEITENWEBER, WILHELM RUDOLPH. Der arabische Kaffee, in naturgeschichtlicher, chemischer, diätetischer und ärztlicher Beziehung für aerzte und nichtärzte geschildert. Prag, 1837. 130 pp.
- ZIMMERMANN, ALBRECHT. Eenige pathologische en physiologische waarnemingen over koffie. Batavia, 1904. 105 pp.

## Periodicals

- ABD-AL-KADIR ANSARI DJEZERI HANBALI. Auszug aus dem Werke: Deutliche Darstellung über den erlaubten Gebrauch des Kaffees; aus dem Arabischen von von Sontheimer. Wissenschaftliche Annalen der gesammten Heilkunde, 1834, XXIX.
- ABELIN, J. and PERELSTEIN, M. Ueber die flüchtigen Bestandteile des Kaffees. Münchener medicinische Wochenschrift, 1914, LXI:867.
- AMORY, ROBERT. Coffee as a beverage: its use and abuse. Boston Medical and Surgical Journal, 1909, CLX:611-613. Also, Journal of Inebriety, 1910, XXXII:23-27; Scientific American Supplement, Jan. 1910, LXIX:26-27.
- BALLAND, A. Les cafés. Annales d'Hygiène, 1904, 4 ser., II:497-532.
- BARDET, G. Un cas d'empoisonnement aigu par le café. Bulletin général de Thérapeutique, 1911, CLXII:56-59.
- BENT, T. On the disorders produced by the use of tea and coffee, with remarks on their treatment. Lancet, 1843, I:893.
- BOETTICHER, J. G. Vertigo satis vehemens a nimio potu coffee, aliisque in diaeta commissis erroribus. Acta physico-medica Academiae Caesareae naturae curiosorum, etc. 1742, VI:158-160.
- BORUTTAU, H. Zur Frage der wirksamen Kaffeebestandteile. Zeitschrift für physikalische und diätetische Therapie, 1908, XII:138-145.
- BOURET, O. Un nouveau cas de caféisme chronique. L'Écho médical du Nord, 1902, VI:171-173.
- BRAM, I. The truth about coffee drinking. Medical Summary, 1913, XXXV:168-173.
- BRIDGE, N. Coffee-drinking as a frequent cause of disease. Association of American Physicians, Transactions, 1893, VIII:281-288.
- CABANEÈS. Une légende sur le café. Journal de Médecin de Paris, 1892, 2 ser., IV:511. Also, translated, Cincinnati Lancet-Clinic, 1893, n. s. XXX:13-17.
- CHARANNE, H. Coffee. Journal of the Medical Society of New Jersey, 1911-2, VIII:19-22.
- CHEEVER, D. W. Properties of coffee. Atlantic Monthly, III:35.
- COLE, J. On the deleterious effects produced by drinking tea and coffee in excessive quantities. Lancet, 1832-3, II:274-478.
- COLETTI, F. Sull' azione del caffè. Gazzetta medica italiana, provincie venete, 1862, V:424, 429, 440, 458; 1863, VI:20.
- COMBEMALE, F. Quelques réflexions à propos d'un cas de caféisme chronique. Bulletin de la Société centrale de Médecine du Nord, 1900, 2 ser., IV:77-87. Also, L'Écho médical du Nord, 1900, IV:97-100.

- COMMAILLE, A. Étude sur le café. *Moniteur scientifique*, 1876, 3 ser., VI:779-785.
- COUGHLIN, R. E. Use and abuse of coffee. *New York Medical Journal*, 1911, XCIV:283-285.
- COULIER. Note sur le café. *Recueil de Mémoires de Médecine, de Chirurgie et de Pharmacie militaires*, 1864, 3 ser., XI:508-511.
- CRETAL, M. Un cas de caféisme chronique. *Bulletin de la Société centrale de Médecine du Nord*, 1901, 2 ser., V:165-167. *Also*, *L'Echo médical du Nord*, 1901, V:318.
- CURSCHEMANN, H. Ein Fall von Kaffee-intoxication. *Deutsche Klinik*, 1873, XXV:377-380.
- DANIEL, M. Die Schädlichkeit des Kaffees. *Leipziger medizinische Monatsschrift*, 1907, XVI:38-40.
- DA SILVA, P. J. O café e a saude publica. *Correio (O) medico de Lisboa*, 1873-4, III:282; 1874-5, IV:27, 206.
- DORVAULT. Note pharmacologique sur le café et la caféine. *Bulletin général de Thérapeutique*, 1850, XXXVIII:498-502.
- DUPOUY. De l'influence du café au point de vue social et hygiénique. *Médecin*, 1878, IV:no. 44, 1.
- FEGRÆUS, E. Kaffee missbruket och folkhälian. (The misuse of coffee and health.) *Hälsövännen*, 1913, XXVIII:257-261.
- FORT, J. A. Des effets physiologiques du café; d'après des expériences faites sur l'auteur. *Bulletin général de Thérapeutique*, 1883, CIV:550-554. *Also*, *Comptes rendus de l'Académie des Sciences*, 1883, XCVI:793-796.
- FRANKEL, F. HULTON. Coffee truly a food. *The Tea and Coffee Trade Journal*, 1917, XXXII:142.
- GASPARIN. Sur le régime alimentaire des mineurs belges; influence remarquable du café. *Bulletin général de Thérapeutique*, 1850, XXXVIII:380-383. *Also*, *Comptes rendus de l'Académie des Sciences*, 1850, XXX:397-403.
- GILLES DE LA TOURETTE, and GASNE. Sur l'intoxication chronique par le café. *Bulletin et Mémoires de la Société médicale des Hôpitaux*, 1895, 3 ser., XII:558-566.
- GOUREWITSCH, D. Ueber des Verhalten des Coffein im Tierkörper mit Rücksicht auf die Angewöhnung. *Archiv für experimentelle Pathologie und Pharmakologie*, 1907, LVII:214-221.
- GUELLOT, O. Du caféisme chronique. *Union médicale et scientifique du Nord-Est*, 1885, IX:181, 221.
- GUIMARAES, E. A. R. Sur l'action physiologique du café. *Comptes rendus de l'Académie des Sciences*, 1882, XCV:1372-1374.
- Sur l'action physiologique et hygiénique du café. *Archives de Physiologie normale et pathologique*, 1884, 3 ser., IV:252-286.
- De l'usage et de l'abus du café. *Archives de Physiologie normale et pathologique*, 1883, 3 ser., I:312-319.
- GUIMARAES, E. A. R. and RAPOSO, A. E. J. Acção physiologica e terapeutica do café. *Gazeta medica brasileira*, 1882, I:121, 179, 223, 275.
- H., D. P. An effect of coffee. *British Medical Journal*, 1910, I:300.
- HARTWICH, C. Beiträge zur Kenntniss des Kaffees. *Zeitschrift für Untersuchung der Nahrungs- und Genussmittel*, 1909, XVIII:721-733.
- HEINRICH, J. B. Die Kaffeefrage in ihrer volkshygienischen und volkswirtschaftlichen Bedeutung. *Medizinische Klinik*, 1906, II:383-385.
- Also*, in Dutch, *Geneeskundige Courant voor het Koninkrijk der Nederlanden*, 1907, LXI:321.
- HELBICH. Wypadki z naduzycia kawy. (On the abuse of coffee.) *Gazeta lekarska*, 1870, IX:257-262.
- HENNIG, C. Der Kaffee vom ärztlichen Standpunkte. *Memorabilien. Heilbroun*, 1882, n. s., II:217-221.
- Weitere Bellge für das Schädliche des orientalischen Kaffees betreffs Gesunder. *Memorabilien. Heilbroun*, 1886, n. s., VI:468.
- HUEPPE, F. Ueber den Missbrauch von Kaffe Blätter für Gesundheitspflege, 1906, VI:121-126.
- JACKSON, S. On the influence upon health of the introduction of tea and coffee in large proportion into the dietary of children and the labouring classes. *American Medical Association, Transactions*, 1849, II:635-644. *Also*, *American Journal of Medical Science*, 1849, n. s., XVIII:79-86.
- KARG. Ueber den Kaffee. *Archiv gemeinnütziger physischer und medizinischer Kenntniss*, 1788-9, II:1, 584.
- LEHMANN, JULIUS. Ueber den Kaffee als Getränk in chemisch-physiologischer Hinsicht. *Annalen der Chemie*, 1853, LXXXVII:205-217. *Also*, in English, *Medical Examiner*, 1854, X:19, 98.
- LEREBoullet, L. Le caféisme. *Gazette hebdomadaire de Médecine et Chirurgie*, 1885, 2 ser., XXII:626-628.
- LEWIS, CHARLES. Educating the physician. *The Tea and Coffee Trade Journal*, 1914, XXVII:544-547.
- LIEBIG, J. VON Coffee. *Pharmaceutical Journal*, 1886, II. pt. 7, 412, 416. *Also*, in German, *Zeitschrift für gerichtliche Medicin*, 1867, III:78, 88.
- LLOYD, JOHN URI. Concerning coffee. *Tea and Coffee Trade Journal*, 1913, XXV:555-560.
- LOVE, I. N. Coffee; its use and abuse. *Journal of the American Medical Association*, 1891, XVI:219-221.
- MENDEL, F. Die schädlichen Folgen des chronischen Kaffeemissbrauchs. *Berliner klinische Wochenschrift*, 1889, XXVI:880-887.
- NILES, GEORGE M. A dietetist on coffee. *Tea and Coffee Trade Journal*, 1910, XIX:27-29.
- Some facts and fallacies about coffee. *Gulf States Journal of Medicine and Surgery*, 1910, XVI:352-357.
- NYSTRÖM, A. Föredrag öfver kaffe och thé. *Upsala Läkareforeninge Förhandlingar*, 1865-6, I:129-132.
- PAOLUCCI, F. Dell' infusodi caffè. *Il Raccoglitore medico*, 1882, 4 ser., XVIII:531-541.
- PAPILLON, G. E. Accidents consécutifs à la suppression brusque du café chez les caféiques; café et antipyrine. *France médicale*, 1899, XLVI:753.
- POULET, V. Inconvénients de l'usage des caféiques. *Bulletin médical de Vosges*, 1897-8, II, no. 45, 45-55.
- PRESCOTT, A. B. Coffee in comparison with tea. *Physician and Surgeon, Ann Arbor*, 1880, II:337-343.
- RABUTEAU. Sur un moyen propre à annuler les effets de l'alimentation insuffisante. *Comptes rendus de l'Académie des Sciences*, 1870, LXXXI:426-428.
- RICHARDSON, H. The coffee habit. *Dietetic and Hygienic Gazette*, 1906, XXII:385-389.
- ROCH, M. La caféisme chronique. *Archives des*



- Maladies due Cœur, 1916. IX:19-33. Also, Revue médicale de la Suisse Romande, 1914, XXXIV:217-219.
- SCOBY. De l'action du café. Archives belges de Médecine militaires. 1857, XX:183-189.
- SCHÜRHOFF. Ist der maasvolle Gebrauch von Alkohol, Kaffee, Tabac usw. dem Menschen schädlich? Deutsch-Amerikanische Apotheker-Zeitung, 1911-12, XXXII:4.
- TRIGG, CHARLES W. Coffee's dietetic value. Tea and Coffee Trade Journal; 1919, XXXVII:270. —Saccharin in tea and coffee. Tea and Coffee Trade Journal, 1920, XXXVIII:697.
- UNZER, J. A. Vom Caffee. Der Arzt, 1769, II:126-139.
- USE of coffee as a beverage. Harper's Weekly, Jan. 21, 1911, LV:26.
- VIAUD. Le vertige stomacal et le caféisme. Tribune médicale, 2 ser., XXIX:928-930.
- WALLACE. On the decrease in use of coffee as a beverage. Analyst, 1884, IX:42-44. Also, Polyclinic, 1883-4, I:169.
- WESSELHOEFT, W. On the effects of coffee and their remedy. Journal of Inebriety, 1909, XXXI:176-182. Also, Boston Medical and Surgical Journal, 1909, CLX:608-611.
- WILEY, HARVEY W. Our national beverages. Tea and Coffee Trade Journal, 1912, XXII, Supplement to no. 6, 33-38.
- Temperance in tea and coffee drinking. Tea and Coffee Trade Journal, 1910, XIX:273-274.
- WILHITE, P. A. Coffee and its effects. Transactions of the South Carolina Medical Association, 1882, XXXII:83-86.
- ZOBEL. Reflexionen über kaffeeinhaltige. Genusmittel. Vierteljahrsschrift für die praktische Helikunde, 1858, II:105-136.
- OF CAFFEINE-FREE COFFEE
- BERTRAND, GABRIEL. Sur les cafés sans caféine. Comptes rendus de l'Académie des Sciences, 1905. CXLI:209-211. Also, Bulletin des Sciences Pharmacologiques, 1905, XII:152.
- BORDET, M. Sur un café rendu inoffensif par la décaféination. Bulletin général de Thérapeutique, 1910, CLIX:770-773.
- CHASSEVANT, ALLYRE. Emploi du café décaféiné en thérapeutique. Bulletin général de Thérapeutique, 1912, CLXIV:860-864.
- EINFELDT, W. Koffeinfreier Kaffee. Therapeutische Neuheiten, 1909, IV:83-86.
- GLÜCKSMANN, S. and GÉRINI, C. Einige Untersuchungen über die physiologische Wirkung von koffeinfreien kaffee. Zeitschrift für Untersuchung der Nahrungs- und Genussmittel, 1910, XX:100.
- HARNACK, E. Ueber den koffeinfreien Kaffee Deutsche medizinische Wochenschrift, 1908, XXXIV:1943-1946; 1909, XXXV:254.
- KAKISAWA. Kommt dem koffeinfreien Kaffee eine diuretische Wirkung zu? Archiv für Hygiene, 1913, LXXXI:43-47.
- LEHMANN, K. B. Die wirksamen und wertvollen Bestandteile des Kaffeegetränks mit besonderer Berücksichtigung des koffeinfreien Kaffees Hag. Münchner medizinische Wochenschrift, 1913, LX:281, 357.
- LEHMANN, K. B., and WILHELM, F. Besitzt das Coffeon und die koffeinfreien Kaffeesurrogate eine kaffeeartige Wirkung. Archiv für Hygiene, 1898, XXXII:310-326.
- LENDRICH, K., and MURDFIELD, R. Coffeinfreier Kaffee. Zeitschrift für Untersuchung der Nahrungs- und Genussmittel, 1908, XV:705-715.
- MERCK's manual of the materia medica. 4th ed. New York, 1911. Dekofa, pt. I, p. 28.
- MUNZ, P. Kaffeinfreier Kaffee, ein neues Genussmittel. Arzt als Erzieher, 1908, IV:40.
- REINSCH. Kaffeinfreier Kaffee. Berichte des Stadt Untersuchungs Amtes Altona, 1906.
- SCHLESINGER, E. Zur Geschichte des koffeinfreien Kaffees. Deutsche medizinische Wochenschrift, 1908, XXXIV:2228.
- WIMMER, K. Ueber koffeinfreien Kaffee, ein neues Genussmittel. Verhandlung der Gesellschaft deutscher Naturforscher und Aerzte, 1909, pt. 2, 111-113.
- OF CHEWING COFFEE
- COFFEE-CHEWING habit. Current Literature, 1903, XXXIV:496.
- OF DIFFERENT CONSTITUENTS
- BUTLER, GEORGE F. (Caffein). In his, Materia Medica, therapeutics and pharmacology. 5th ed., 1906. pp. 256-259.
- HARE, H. AMORY. Physiological action of caffen. In his, Practical therapeutics. 13th ed., 1909. p. 142.
- HENNEGUY, LOUIS-FELIX. Caféine. In his, Étude physiologique sur l'action des poisons, pp. 85-89. Inaugural dissertation. Montpellier, 1875.
- HUCHARD, HENRY. De la caféine dans les affections du cœur. O. Bois, 1882.
- JOHANNSEN. Über die Wirkungen des Kaffein. Inaugural dissertation, Dorpat, 1869.
- KUNKEL, A. J. Handbuch der Toxikologie. Jena, 1899. 2 v. See index: Coffein, Kaffee.
- LEBLOND. Étude physiologique et thérapeutique de la caféine. Paris, 1883. 173 pp.
- LEWIN, L. (Caffein poisoning.) In his, Traité de toxicologie, 1903, pp. 690-692.
- MEYER, HANS H. and GOTTLIEB, R. Pharmacology, clinical and experimental, tr. by John T. Halsey. Philadelphia and London, 1914. 604 pp. See index: Caffeine.
- PARISOT, E. Étude physiologique de l'action de la cafeine. Paris, 1890. 112 pp.
- POTTER, S. O. L. Caffeina, cafeine. Physiological action. Therapeutics. In his, Therapeutics, materia medica and pharmacy, 4th ed. 1912. pp. 186-192.
- RIVERS, W. H. R. The influence of alcohol and other drugs on fatigue. II. Caffeine. London, 1908. pp. 22-50, 127-130.
- SCHUTZKWER, NACHUM. Das Coffein und sein Verhalten im Thierkörper. Inaugural dissertation, Königsberg, 1882. 25 pp. Also, Schmidt's Jahrbücher, 1883, CXCVIII:232-233.
- VOIT, CARL. Untersuchung über die Wirkung des Kaffees auf den thierischen Organismus. In his Untersuchung über den Einfluss des Kochsalzes, des Kaffees und der Muskelbewegungen, München, 1860. pp. 67-147.
- WEIGL, J. Das Koffein. Leipzig, 1905.
- WILHELM, F. Ist das Coffeon an der Kaffeewirkung beteiligt? Würzburg, 1895.
- Periodicals
- ALBANESE, MANFREDI. Ueber die Bildung von 3-Methyl-xanthin aus Coffein im thierischen Organismus. Berichte der deutschen chemischen

- Gesellschaft, 1899, XXXII; no. 360: 2280-2282.
- Ueber das Verhalten des Coffeins und des Theobromins im Organismus. *Archiv für experimentelle Pathologie und Pharmakologie*, 1895, XXXV:449-466.
- ALBERS, J. F. H. Ueber die eigenthümliche Wirkung des Theinum und Coffeinum citricum auf den thierischen Körper. *Deutsche Klinik*, 1852, IV:577-579.
- AUBERT, H. Ueber den Coffeingehalt des Kaffegetränkes und über die Wirkungen des Coffeins. *Archiv für die gesammte Physiologie des Menschen und der Thiere*, 1872, V:589-628.
- BINZ, C. Beitrag zur Toxikologie des Coffeins. *Archiv für experimentelle Pathologie und Pharmakologie*, 1891, XXVIII:197-200.
- BONDZYŃSKI, ST. and GOTTLIEB, R. Ueber Methylxanthin, ein Stoffwechselprodukt des Theobromin und Coffein. *Archiv für experimentelle Pathologie und Pharmakologie*, 1895, XXXVI:45-55. Also, *Berichte der deutschen chemischen Gesellschaft*, 1895, XXVIII: no. 221, 1113-1118.
- BUSQUET, H. and TIEFFENBAU, M. Du rôle de la caféine dans l'action cardiaque du café. *Comptes rendus de l'Académie des Sciences*, 1912, CLV:362-365.
- COGSWELL, CHARLES. On the local action of poisons. *LANCET*, 1852, no. 2:488-491.
- FÉRÉ, CHARLES. Note sur l'influence de la théobromine sur le travail. *Comptes rendus de la Société de Biologie*, 1901, 2. ser., III:593-594, 627-629.
- FRANKEL, F. HULTON. Caffein as a body warmer. *Tea and Coffee Trade Journal*, 1916, XXXI:354-355.
- GANZER, E. Ueber ein neues Verfahren der Kaffee-Entgiftung auf physikalischer Grundlage. *Der praktische Arzt*, 1914, LIV:152-175.
- GERBIS, H. Vergiftung mit anilinöhlhaltigen Kaffee. *Aerztliche Sachverständigen-Zeitung*, 1913, XIX:467.
- GERÁTY, T. Poisoning by citrate of caffeine. *Lancet*, 1889, I:219.
- GOUGET, A. Coffee and tea poisoning. *Journal of Inebriety*, 1908, XXX:92-102.
- HANNA, W. J. Chronic coffee poisoning. *Occidental Medical Times*, 1903, XVII:148.
- HARE, H. A. and MARSHALL, J. The physiological effects of the empyreumatic oil of coffee or caffeine. *Medical News*, 1888, LII:337-339.
- HARNACK, E. Zur Frage nach der Schädlichkeit des Kaffees. *Deutsche medizinische Wochenschrift*, 1907, XXXIII:26-28.
- HOLLINGWORTH, H. L. Caffein as a stimulant. *Tea and Coffee Trade Journal*, 1912, XXIII, Supplement to no. 6:52-56.
- IOTYKO, J. Etude physiologique et mathématique. IX. Caféine. *Institut Solvay. Travaux de Laboratoire*, 1903, VI:474-485.
- JACOB, C., and GOLOWINSKI. Ein Beitrag zur Frage der verschiedenen Wirkung des Coffeins auf *Rana esculenta* und *Rana temporaria*. *Archiv für experimentelle Pathologie und Pharmakologie*, 1908, Supplement, 286-298.
- KOSCHLAKOFF. Beobachtungen über die Wirkung des citrone sauren Coffeins. *Virchow's Archiv für pathologische Anatomie und Physiologie*, 1864, XXXI:436-443.
- KRÜGER, MARTIN. Ueber den Abbau des Cafféins im Organismus des Hundes. *Berichte der deutschen chemischen Gesellschaft*, 1899, XXXII, no. 431:2818.
- Ueber den Abbau des Cafféins im Organismus des Kaninchens. *Berichte der deutschen chemischen Gesellschaft*, 1899, XXXII, no. 488:3336.
- KURZAK. Die Wirkungen des Kaffees auf Thiere. *Schmidt's Jahrbücher*, 1861, CIX:172.
- LANGFELD, H. S. Tests with alcohol and caffeine. *Psychological Review*, 1911, XVIII:413, 424.
- LEVEN, M. Action physiologique et médicamenteuse de la caféine. *Archives de Physiologie*, 1869, I:179-189.
- LEVINTHAL, WALTER. Zum Abbau des Xanthins und Coffeins im Organismus des Menschen. *Zeitschrift für physiologische Chemie*, 1912, LXXVII:259-279.
- MALY, RICHARD and ANDREASCH, RUDOLF. Studien über Caffein und Theobromin. *Monatshefte für Chemie (Sitzungsberichte der Kaiserlichen Akademie der Wissenschaften)*, 1883, IV:369-387.
- MATTHEWS, W. Observations on the use of coffee as a cause of disease. *Northwest Medical and Surgical Journal*, 1850-51, VII:46-50.
- PARDI. Ricerche intorno alla funzione spermato-genetica negli animali avvelenati con caffè. *Lo Sperimentale*, LXV:17-34.
- PESET CERVERA, V. Del envenamiento por el café. *Géno médico-quirúrgico*, 1877, XXIII:670-673.
- PÉTERESCO, Z. Sur l'action hypercinétique de la caféine à hautes doses ou doses thérapeutiques. *Verhandlungen des X. internationalen medicinischen Congresses, Berlin*, 1890, II, pt. 4, 5-10.
- PILCHER, J. D. Alcohol and caffeine: a study of antagonism and synergism. *Journal of Pharmacology and Experimental Therapeutics*, 1911, III:267-298.
- REICHERT, E. T. The action of caffeine on tissue metamorphosis and heat phenomena. *New York Medical Journal*, 1890, LI:456-459.
- The empyreumatic oil of coffee, or caffeine. *Medical News*, 1890, LVI:476-478.
- RIBAUT, H. Influence de la caféine sur la production de chaleur chez l'animal. *Comptes rendus de la Société de Biologie*, 1901, LIII (2. ser., III):295-296.
- RIEGEL, F. Ueber die therapeutische Verwendung der Caffeinpräparate. *Wiener medizinische Blätter*, 1884, VII:615-619. Also, *Berlin klinische Wochenschrift*, 1884, XXI:289.
- RUGH, J. T. Profound toxic effects from the drinking of large amounts of strong coffee. *Proceedings of the Philadelphia County Medical Society*, 1896, XVII:195. Also, *Medical and Surgical Reporter*, 1896, LXXV:549; *Quarterly Journal of Inebriety*, 1897, XIX:62-64.
- SALANT, WILLIAM and RIEGER, J. B. Elimination and toxicity of caffeine in nephrectomized rabbits. U. S. Dept. of Agriculture. Bureau of Chemistry. *Bulletin*, 1913, CLXVI.
- Toxicity of caffeine: an experimental study on different species of animals. U. S. Dept. of Agriculture. Bureau of Chemistry. *Bulletin*, 1912, CXLVIII.
- SCHMID, JULIUS. Der Abbau methylierter Xanthine. *Zeitschrift für physiologische Chemie*, 1910, LXVII:155-160.
- SCHMEDEBERG, OSWALD. Ueber die Verschiedenheit der Coffeinwirkung an *Rana temporaria* L. und *Rana esculenta* L. *Archiv für experimentelle Pathologie und Pharmakologie*, 1874, II:62-69.
- STUHLMANN, J. and FALCK, C. P. Beiträge zur Kenntniss der Wirkungen des Kaffees. *Vir-*

- chow's Archiv für pathologische Anatomie und Physiologie, 1857, XI:324-383.
- STENSTRÖM, THOR. Über die Coffeinhyperglykämie. Biochemische Zeitschrift, 1913, XLIX:225-231.
- STERRETT, R. M. Coffee; a drug. Chicago Medical Times, Jan. 1910, XLIII.
- THE TRUE "poison in the coffee cup." Medical Record, 1885, XXVII:191.
- UNTERSUCHUNG einer vermutheten Vergiftung durch Kaffee. Blätter für gerichtliche Anthropologie, 1862, XIII:137-141.
- WAENTIG, PERCY. Über den Gehalt des Kaffegetränktes an Koffein und die Verfahren zu seiner Ermittlung. Arbeiten a. d. kaiserl. Gesundheitsamte, 1906, XXIII:315-332.
- WEDEMEYER, T. Habituation of the psychic functions to caffen. Arch., exp. Path. Phar., 1920, 85:339-58.
- WEISMANN. Ein Fall von schweren Vergiftungserscheinungen durch einmaligen unmässigen Genuss von Kaffee. Zeitschrift für Bahn- und Bahnkassenärzte, 1906, I:306.
- ZENETZ. Dangers of caffen. Pharmaceutical Journal, 1900, 4th ser., X:333.
- OF GREEN COFFEE
- LANDARRAHLCO, O. Du café vert envisage au point de vue de ses applications thérapeutiques dans le traitement de la goutte, de la gravelle, des coliques néphrétiques et de la migraine. *Montpelier*, 1866.
- PERRET, E. Sur l'extrait physiologique de café vert. Bulletin général de Thérapeutique, 1910, CLX:214-222.
- SQUIBB. Fluid extract of green coffee. Ephemeric of materia medica, 1884, II:616-619.
- OF LEAVES OF COFFEE TREE
- ON the dried coffee leaf of Sumatra. Pharmaceutical Journal, XIII:207-209, 382-384.
- OF ROASTED COFFEE
- BURMANN, J. Recherches chimiques et physiologiques sur les principes nocifs du café torréfié. Bulletin général de Thérapeutique, 1913, CLXVI:379-400.
- GRINDEL. Fortgesetzte Erfahrungen über den rohen Coffee. Journal der practischen Arzneykunde und Wundarzneykunst, 1809, XXIX, pt. 12, 11-30.
- OFFRET, Observations sur l'action physiologique du café, selon ses diverses torréfactions. *Nantes*, 1862.
- OF SMOKING COFFEE
- SCHMIDT. Ueber Caffee-Räucherung. Mittheilungen aus dem Gebiete der Medicin Chirurgie und Pharmacie, 1832, I:217-220.
- TRAYER, L. Insanity from smoking coffee. Medical and Surgical Reporter, 1864-5, XII:406.
- ON CHILDREN
- JACKSON, S. On the influence upon health of the introduction of tea and coffee in large proportion into the dietary of children and the labouring classes. American Medical Association. Transactions, 1848, II:635-644. Also, American Journal of Medical Science, 1849, n. s. XVIII:79-86.
- TAYLOR, C. K. Effects of coffee drinking on children. Psychological Clinic, 1912-13, VI:56-58.
- WILLIAMS, T. A. A case of psychasthenia in a child aged two years, due to coffee drinking. Archives of Pediatrics, 1910, XXVII:778-782. Also, Pacific Medical Journal, 1911, LIV:221-225.
- ON DIFFERENT ORGANS AND SYSTEMS
- BLADDER
- BECHER, CARL. Coffei als Herztonicum und Diureticum. Wiener Medizinische Blätter, 1884, VII, columns, 639-644.
- BESSER. Die harnsäurevermehrnde Wirkung des Kaffees und der Methylxanthin beim Normalen und Gichtkranken. Therapie der Gegenwart, 1909, n. s. XI:321-327.
- BONDZYŃSKI, ST. and GOTTLIEB, R. Über die Constitution des nach Coffein und Theobromin im Harne auftretenden Methylxanthins. Archiv für experimentelle Pathologie und Pharmakologie, 1896, XXXVII:385-388.
- DUMONT, A. Expériences relative à l'influence du café sur l'excrétion de l'urée urinaire. Revue médicale, 1888, VII:257-260.
- FAUVEL. Action du chocolat et du café sur l'excrétion urique. Comptes rendus de la Société de Biologie, 1908, LXIV:854-856.
- Influence du chocolat du café sur l'acide urique. Comptes rendus de l'Académie des Sciences, 1906, CXLII:1428-1430; 1909, CXLVIII:1541-1544.
- FUBINI, S. and OTTOLENGHI. Influenza della caffeina e dell' infuso caffè sulla quantità giornaliera di urea emessa dall' uomo colle urine. Giornale della reale Accademia di Medicina di P'orino, 1882, ser. 3, XXX:570-574.
- LOEWI, O. Ueber den Mechanismus der Coffeindiurese. Archiv für experimentelle Pathologie und Pharmakologie, 1905, LIII:15-32.
- MENDEL, L. B. Caffen and uric acid. Tea and Coffee Trade Journal, 1917, XXXIII:142-145.
- ROST, E. C. Ueber die Ausscheidung des Coffein und Theobromin im Harn. Archiv für experimentelle Pathologie und Pharmakologie, 1895, XXXVI:56-71.
- ROUX, E. Des variations dans la quantité d'urée excrétée avec une alimentation normale et sous l'influence du thé et du café. Comptes rendus de l'Académie des Sciences, 1873, LXXVII: 365-367.
- S., M. De l'emploi du café comme diurétique. Bulletin général de Thérapeutique, 1839, XVI: 144-148.
- SCHITTEMEHELM, ALFRED. Zur Frage der harnsäurevermehrnden Wirkung von Kaffee und Tee und ihrer Bedeutung in der Gichttherapie. Therapeutische Monatshefte, 1910, XXIV:113-116.
- SCHROEDER, W. von. Ueber die diuretische Wirkung des Coffeins und der zu derselben Gruppe gehörenden Substanzen. Archiv für experimentelle Pathologie und Pharmakologie, 1887, XXIV:85-108.
- Ueber die Wirkung des Coffeins als Diureticum. Archiv für experimentelle Pathologie und Pharmakologie, 1887, XXII:39-61.
- WARDELL, EMMA L. Caffen and uric acid. Tea and Coffee Trade Journal, 1917, XXXIII:142-145.

## CIRCULATION, HEART, ETC.

- ARCHANGELSKY, C. T. Die Wirkung des Destillats von Kaffee und von Thee auf Athmung und Herz. *Archives internationales de Pharmacodynamie*, 1900, VII:405-424.
- AÜBERT, H. and DEHN, A. Ueber die Wirkungen des Kaffees, des Fleischextractes und der Kalisalze auf Herzthätigkeit und Blutdruck. *Archiv für die gesammte Physiologie*, 1874, IX:115-155.
- BECHER, CARL. Coffein als Herztonicum und Diureticum. *Wiener Medizinische Blätter*, 1884, VII, columns, 639-644.
- BECO, LUCIEN and PLUMIER, LÉON. Action cardiovasculaire de quelques dérivés xanthiques. *Journal de Physiologie et Pathologie générale*, 1906, VIII:10-21.
- BINZ, C. Die Wirkung des Destillats von Kaffee und Thee auf Athmung und Herz. *Centralblatt für innere Medicin*, 1900, XXI:1169-1176.
- BOCK, JOHANNES. Ueber die Wirkung des Coffeins und des Theobromins auf das Herz. *Archiv für experimentelle Pathologie und Pharmakologie*, 1900, XLIII:367-399.
- COUTY, GUIMARAES and NIOBEY. De l'action du café sur la composition du sang et les échanges nutritifs. *Comptes rendus de l'Académie des Sciences*, 1884, XCIX:85-87.
- CUSHNY, A. R. and VAN NATEN, B. K. On the action of caffeine on the mammalian heart. *Archives internationales de Pharmacodynamie*, 1901, IX:169-180.
- DUMAS, ADOLPHE. Bons effets de la caféine dans un cas de paralysie du cœur. *Paris*, 1886.
- FREDEBIOQ, HENRI. L'excitabilité du vague cardiaque et ses modifications sous l'influence de la caféine. *Archives internationales de Physiologie*, 1913, XIII:107-125.
- FRENKEL, SOPHIE. Klinische Untersuchungen über die Wirkung von Coffein, Morphin, Atropin, Secale cornutum und Digitalis auf den arteriellen Blutdruck. *Deutsches Archiv für klinische Medizin*, 1890, XLVI:542-582.
- FÜRST. Die Gefahren des Kaffees bei Herz- und Arterien-leiden. *Deutsche medicinische Presse*, 1905, IX:91.
- HEDBOM, KARL. Ueber die Einwirkung verschiedener Stoffe auf das isolirte Säugethierherz. *Skandinavisches Archiv für Physiologie*, 1899, IX:1-72.
- HUCHARD, HENRI. De la caféine dans les affections du coeur. *Bulletin général de Thérapeutique*, 1882, CIII:145-154.
- LANDEREGREN, E. and TIGERSTEDT, R. Studien über die Blutvertheilung im Körper. *Skandinavisches Archiv für Physiologie*, 1892-93, IV:241-280.
- LOEB, OSWALD. Ueber die Beeinflussung des Koronarkreislaufs durch einige Gifte. *Archiv für experimentelle Pathologie und Pharmakologie*, 1904, LI:64-83.
- MIRANO, G. C. L'azione della caffeina sulla pressione del pulso. *La Riforma medica*, 1906, XXI; no. 38. Reviewed in *Biochemisches Centralblatt*, 1906-7, V:205.
- PACHON, V. and PERROT, E. Sur l'action cardiovasculaire du café vert, comparée à celle des doses correspondantes de cafeine. *Comptes rendus de l'Académie des Sciences*, 1910, CL:1703-1705.
- PHILLIPS, C. D. F. and BRADFORD, J. R. On the action of certain drugs on the circulation and secretion of the kidney. *Journal of Physiology*, 1887, VIII:117-132.
- PILCHER, J. D. The action of caffeine on the mammalian heart. *Journal of Pharmacology and Experimental Therapeutics*, 1912, III:609-624.
- RABE. The action of coronary vessels to drugs. *Zeitschrift für experimentelle Pathologie*, 1912, XI:175.
- REICHERT, E. T. Action de la caféine sur la circulation. *Bulletin général de Thérapeutique*, CXIX:86. Also in English, *Therapeutic Gazette*, 1890, n. s. VI:294.
- SANTESSON, C. G. Einige Versuche über die Wirkung des Coffeins auf das Herz des Kaninchens. *Skandinavisches Archiv für Physiologie*, 1901-2, XII:259-296.
- SOLLMANN, T. and PILCHER, J. D. The actions of caffeine on the mammalian circulation. *Journal of Pharmacology and Experimental Therapeutics*, 1911, III:19-92.
- TRZECESKI, A. Ueber die Wirkung der Antipyretica auf das Herz. II. Ueber die Wirkung des Kaffees und Theobromins auf das Herz. *Jahresbericht der Thierchemie*, 1909, XXXIX:1268.
- VAN LEEUWEN, W. S. Quantitative pharmakologische Untersuchungen über die Reflexfunktionen des Rückenmarkes an Warmblütern. *Archiv für die gesammte physiologie*, 1913, CLIV:307-342.
- VINCI, G. Azione della caffeina sulla pressione sanguigna. *Archivo di Farmacologia e Terapeutica*, 1895, 8. Reviewed, *Revue des Sciences médicales*, 1896, XLVII:80.

## DIGESTIVE ORGANS

- BIKFALVI, KARL. Ueber die Einwirkung von Alcohol, Bier, Wein, Wasser von Borssik, schwarzem Kaffee, Tabak, Kochsalz und Alaun auf die Verdauung. *Jahresbericht der Thierchemie*, 1885, XV:273.
- BURLAN, RICHARD and SCHUR, HEINRICH. Ueber die Stellung der Purinkörper im menschlichen Stoffwechsel. *Archiv für die gesammte Physiologie*, 1900, LXXX:241-343.
- CRÄMER. Ueber den Einfluss des Nikotins, des Kaffees und des Thees auf die Verdauung. *Münchener medizinische Wochenschrift*, 1907, LIV, pt. 1, 929-931, 988-991.
- EDER, MAX. Studien über den Wert und die Wirkung des Kaffees auf die Tätigkeit der Wiederkäuermägen. Inaugural Dissertation, *Giessen*, 1912. 88 pp. Summarized, *Zentralblatt für Biochemie und Biophysik*, 1912, XIII:504.
- FARR, C. B. and WELKER, W. H. The effect of caffeine on nitrogenous excretion and partition. *American Journal of the Medical Sciences*, 1912, CXLIII:411-415.
- FLEHNE, WILHELM. Ueber einige Wirkungen des Xanthins, des Caffeins und mehrerer mit ihnen verwandter Körper. *Archiv für Anatomie und Physiologie*, 1886, 72-91.
- GOTTLIEB, R. and MAGNUS, R. Ueber die Beziehungen der Nierencirculation zur Diurese. *Archiv für experimentelle Pathologie und Pharmakologie*, 1901, XLV:223-247.
- GUIMARAES, E. A. R. De l'action du café sur la consommation d'aliments azotés et hydrocarbonés. *Comptes rendus de la Société de Biologie*, 1883, ser. 7, V:590-592.
- GUIMARAES, E. A. R. and NIOBEY. De l'action du café sur la nutrition et sur la composition du sang. *Comptes rendus de la Société de Biologie*, 1883, ser. 7, IV:546-550. Also, *Comptes rendus de l'Académie de Sciences*, 1884, XCIV:85-87.

- HALE, WORTH. Influence of certain drugs upon the toxicity of acetanilide and antipyrine. Public Health and Marine-Hospital Service of the U. S. Hygienic Laboratory. Bulletin, no. 53, p. 43, Experiments with caffeine citrate.
- HEERLEIN, W. Das Coffein und das Kaffeedestillat in ihrer Beziehung zum Stoffwechsel. Archiv für die gesammte Physiologie, 1892, LIII.
- KOTAKE, Y. Ueber den Abbau des Coffeins durch den Auszug aus der Rinderleber. Zeitschrift für physiologische Chemie, 1908, LVII:378-381.
- LAWSCHEITZ, O. Ueber den Einfluss des Kaffees auf den Eiweis-stoffwechsel beim Menschen. *Basel*, 1914.
- MARCHAND, EUGENE. Le café du lait est une soupe au cuir. *Revue de Thérapeutique médico-chirurgicale*, 1873, 261.
- NAGEL. Die Wirkung des Café's auf eingeklemmte Darmparthien. *Allgemeiner Wiener medizinische Zeitung*, 1872, XVII:391.
- NAGASAKI, S. and MATSUOKA, Z. Ueber den Abbau des Kaffeins und Theobromins durch den Rinderpankreas und Stierhodenauszug. *Kyoto Igaku-zashi*, 1912, IX; H. 3. Summarized, *Zentralblatt für Biochemie und Biochemie und Biophysik*, 1912-13, XIV:743.
- OGATA, MASANORI. Ueber den Einfluss der Genussmittel und Magenverdauung. *Archiv für Hygiene*, 1885, III:204-214.
- PAWLOWSKY, I. Ueber den Einfluss von Tee, Kaffee und einigen alkoholischen Getränken auf die quantitative Pepsinwirkung. *Jahresbericht der Tierchemie*, 1903, XXXIII:543.
- PINCUSOHN, LUDWIG. Die Wirkung des Kaffees und des Kakaos auf die Magensaftsekretion. *Münchener medizinische Wochenschrift*, 1906, LIII, pt. I, 1248-1249.  
—Ueber das sekretionsfordernde Prinzip des Kaffees. *Zeitschrift für physikalische und diätetische Therapie*, 1907, XI:261-263.
- RABUTEAU. Recherches sur l'action des caféiques sur la nutrition. *Gazette médicale de Paris*, 1870, XXV:593. Also, *Comptes rendus de la Société de Biologie*, 1872, ser. 5, II:77-81.
- RIBAUT, H. Influence de la caféine sur l'excrétion azotée. *Comptes rendus de la Société de Biologie*, 1901, LIII, (ser. 2, III):393-395.
- SASAKI, TAKAOKI. Experimentelle Untersuchungen über den Einfluss des Tees auf die Magensaftsekretion. *Berliner klinische Wochenschrift*, 1905, XLII:1526-1528.
- SCHMEDEBERG, OSWALD. Vergleichende Untersuchungen über die pharmakologischen Wirkungen einiger Purinderivate. *Berichte der deutschen chemischen Gesellschaft*, 1901, XXXIV, no. 395, 2550-2559.
- SCHULTZ-SCHULTZENSTEIN, C. Versuche über den Einfluss von Caffee- und Thee- Abkochungen auf künstliche Verdauung. *Zeitschrift für physiologische Chemie*, 1893-94, XVIII:131.
- STORY, W. Coffee as an absorbent. *Lancet*, 1873, II:617.
- TOGAMI, K. Ueber den Einfluss einiger Genussmittel auf die Wirksamkeit der Verdauungsenzyme. *Biochemisches Zeitschrift*, 1908, IX:453-462.
- TYRODE, M. V. Caffeine on the gastro-intestinal tract. *Boston Medical and Surgical Journal*, 1911, CLXIV:686.
- CROTHERS, T. D. Effects of coffee upon the eyes and ears. In his, *Disease of inebriety from alcohol, opium and other narcotic drugs*, New York, 1893. p. 309.
- FRENCH, H. C. Coffee drinking and blindness. *North American Review*, 1888, CXLVII:584-585.
- HOLADAY, J. M. Coffee-drinking and blindness. *North American Review*, CXLVII:302.
- WING, P. B. Report of a case of toxic amblyopia from coffee. *Annals of Ophthalmology*, 1903, XII:232-234.

## LACTATION

- FRANKL, J. Ueber die Anwendung von Kaffee bei den Krankheiten der Säuglinge. *Wiener medizinische Wochenschrift*, 1872, XXII:384.
- OBIDENNIKOFF, E. O vlijanii kofe na kolichestvo i kolichestven sostave moloka. (Influence of coffee on lactation). *St. Petersburg*, 1871.

## MUSCULAR SYSTEM

- BENEDICENTI, A. Ergographische Untersuchungen über Kaffee, Thee, Maté, Guarana und Coca. Moleschott's Untersuchungen zur Naturlehre, 1899, XVI:170-186.
- BUCHHEIM and EISENMENGER. Ueber den Einfluss einiger Gifte auf die Zuckungcurve des Froschmuskels. III. Caffein. *Beiträge zur Anatomie und Physiologie*, 1870, V:113-118.
- DESTREE, E. Effets immédiats et tardifs de la caféine sur le travail. *Journal médical de Bruxelles*, 1897, II:231, 577.
- DRESER, H. Ueber die Messung der durch pharmakologische Agentien Bedingten Veränderungen der Arbeitsgrösse und der Elasticitätszustände des Skelettmuskels. *Archiv für experimentelle Pathologie und Physiologie*, 1904, XVI:139-221.
- KOERT, E. R. Ueber den Einfluss verschiedener pharmakologischer Agentien auf die Muskelsubstanz. *Archiv für experimentelle Pathologie und Pharmakologie*, 1882, XV:22-79.
- LUSINI, V. Biologische und toxische Wirkung der methylylirten Xanthine insbesondere ihr Einfluss auf die Muskelermüdung. *L'Orosi*, XXI.
- MOSSO, UGOLINO. Action des principes actifs de la noix de kola sur la contraction musculaire. *Archives italiennes de biologie*, 1893, XIX:241-256.
- OSERETZKOWSKY, A. and KRAEPELIN, E. Ueber die Beeinflussung der Muskelleistung durch verschiedene Arbeitsbedingungen. V. Der Einfluss von Alkohol und Coffein. *Psychologische Arbeiten*, 1901, III:617-643.
- PASCHKES, H. and PAL, J. Ueber die Muskelwirkung des Coffeins, Theobromins und Xanthins. *Wiener medizinische Jahrbücher*, 1886, 611-617.
- RANSOM, F. The action of caffeine on muscle. *Journal of Physiology*, 1911, XLII:144-155.
- RIVERS, W. H. R. and WEBBER, H. N. The action of caffeine on the capacity for muscular work. *Journal of Physiology*, 1907-8, XXXVI:33-47.
- ROSSI, CESARE. Ricerche sperimentali sulla fatica dei muscoli umani. Caffaina. *Rivista sperimentale di Freniatria*, 1894, XX:458-462.
- SACKUR. Ueber die tödliche Nachwirkung der durch Kaffee erzeugten Muskelstarre. *Virchow's Archiv für pathologische Anatomie und Physiologie*, 1895, CXLI:479-484.
- SCHUMBERG. Ueber die Bedeutung von Kola, Kaffee, Thee, Maté und Alkohol für die Leistung der Muskeln. *Archiv für Anatomie und Physiologie*, 1899, 289-313.

## EYES AND EARS

- BULSON, A. E. Coffee amblyopia. *American Journal of Ophthalmology*, 1905, XXII:55-64.



- SOBIERANSKI, W. Ueber den Einfluss der pharmakologischen Mittel auf die Muskelkraft der Menschen. *Gazeta lekarska*, 1896. Summarized, *Centralblatt für Physiologie*, 1896, X:126.
- WOOD, H. C. The effects of caffeine on the circulatory and muscular systems. *Therapeutic Gazette*, 1912, XXXVI, (ser. 3, XXVIII):6-13.
- NERVOUS SYSTEM, BRAIN, ETC.
- ACH, NARZISS. Ueber die Beeinflussung der Auffassungsfähigkeit. *Psychologische Arbeiten*, 1901, III:203-289.
- DEHIO, HEINRICH. Untersuchungen über den Einfluss des Coffeins und Thees auf die Dauer einfacher psychischer Vorgänge. Inaugural dissertation, *Dorpat*, 1887. 55 pp.
- DIETH, M. J. and VINTSCHGAU, M. VON. Das Verhalten der physiologischen Reactionzeit unter dem Einfluss von Morphium, Caffée und Wein. *Archiv für gesammte Physiologie*, 1878, XVI:316-406.
- DIXON, W. E. The paralysis of nerve cells and nerve endings with special reference to the alkaloid apocodeine. *Journal of Physiology*, 1904, XXX:97-131.
- HOCH, AUGUST and KRAEPELIN, E. Ueber die Wirkung der Theebestandtheile auf körperliche und geistige Arbeit. *Psychologische Arbeiten*, 1896, I:378-488.
- HOLLINGWORTH, H. L. Influence of caffeine on mental and motor efficiency. *Archives of Psychology*, 1912, XXII:166. Also, *Therapeutic Gazette*, 1912, XXXVI:1.
- HOPPE, I. Des effets de la cofféine sur le système nerveux des animaux. *L'Écho médical*, 1858, II:449-460.
- KIONKA, H. (Caffein and coffee as nerve poisons.) *Grundriss der Toxicologie*, 1901:331-336.
- LE GRAND, DU SAULLE. De l'insalubrité de l'atmosphère des cafés et de son influence sur le développement des maladies cérébrales. *Gazette des Hôpitaux*, 1861; also *Academie des Sciences*, 1861.
- LESZYNSKY, W. M. Coffee as a beverage and its frequent deleterious effects upon the nervous system; acute and chronic coffee poisoning. *Medical Record*, 1901, LIX:41-44.
- MCMAKIN, A. L. Influence of coffee on brain workers. *Good Housekeeping*, 1912, LIV:381-382.
- PALDANUS. Ein Paar Worte über Kaffee als Fiebermittel und Medikament überhaupt. *Neues Archiv für medizinische Erfahrung*, 1809, XI:318-322.
- PETT, H. De l'emploi préventif et curatif du café, notamment dans les congestions cérébrales. *Gazette des Hôpitaux*, 1862, XXXV:446.
- DE SARLO, F. and BERNARDINI, C. Ricerche sulla circolazione cerebrale. I. Ischemizzanti. *Caffeici*. *Rivista sperimentale di Freniatria*, 1892, XVIII:8-14.
- SWIRSKI, G. Ueber die Beeinflussung des Vaguscentrums durch das Coffein. *Archiv für gesammte Physiologie*, 1904, CIV:260-292.
- WILLIAMS, T. A. Coffee and the nervous system. *Medical Summary*, 1912.
- RESPIRATION
- ARCHANGELSKY, C. T. Die Wirkung des Destillats von Kaffee und von Thee auf Athmung und Herz. *Archives internationales de Pharmacodynamie*, 1900, VII:405-424.
- BINZ, C. Die Wirkung des Destillats von Kaffee und Thee auf Athmung und Herz. *Centralblatt für innere Medicin*, 1900, XXI:1169-1176.
- CUSHNY, A. R. The action of drugs on the respiration. *Proceedings of the Royal Society of Medicine*, 1912-13, VI, pt. 3:130.
- EDSALL, D. L. and MEANS, J. H. The effect of strychnine, caffeine, atropin and camphor on the respiratory metabolism in normal human subjects. *Archives of Internal Medicine*, 1914, XIV:897-910.
- LEHMANN, K. B. and ROHRER, G. Besitzen die flüchtigen Bestandteile von Thee und Kaffee eine Wirkung auf die Respiration des Menschen? *Archiv für Hygiene*, 1902, XLIV:203.
- SÉE, G. and LAPICQUE. Action de la caféine sur les fonctions motrices et respiratoires, à l'état normal et à l'état d'inanition. *La Médecine moderne*, 1890, I:228-234.
- SUBSTITUTES
- GENERAL
- BIBRA, Baron von. Der kaffee und seine surrogate. *Munich*, 1858.
- CHRIST, J. L. Der neueste und beste deutsche Stellvertreter des indischen Caffee oder der Coffee von Erdmandeln; zu Ersparung vieler Millionen Geldes für Deutschland und längeren Gesundheit Tausender von Menschen. 2 ed. *Frankfurt-am Main*, 1801.
- FRANKE, ERWIN. Kaffee, Kaffeeconserven und Kaffeesurrogate. *Wien*, 1907. 221 pp.
- FREEMAN, W. G. and CHANDLER, S. E. Coffee and coffee substitutes. In their, *The world's commercial products*. *London*, 1907. pp. 174-198.
- GRESTER, C. Kaffee und Kaffee-Surrogate. In ihrer, *Bedeutung für den praktischen Arzt*. *Berlin*, 1894.
- GUNDRIZER, R. F. O surrogatje kofe, prigotovlyayemom iz siemyan sinyavo lyupina (*Lupinus angustifolius* L.) (On a substitute for coffee, from the seeds of . . .) *St. Petersburg*, 1892.
- LEHMANN, K. Die Fabrikation des Surrogat kaffees und des Tafelsenses. *Wien*, 1877. 128 pp.
- LOCHNER, N. F. De novis et exoticis Thée et Café succédanéis. *Noribergae*, 1717.
- MENIER, E. J. Café: succédané du café, cacao et chocolat, coca et thé maté. *Paris*, 1867. 24 pp. (Jury report, Exposition Universelle de 1867, à Paris.)
- TRILLICH, HEINRICH. Die kaffee surrogate. *München*, 1889.
- WEICHHARDT, T. T. Succedaneorum coffeae inveniendorum regulas proponit. *Lipsiae*, 1774.
- Periodicals
- ACORN coffee. *Pharmaceutical Journal*, 1876, p. 772.
- BASCH, ALBERT. Rapport sur le café de figue. *Société de Géographie d'Alger et de l'Afrique du Nord*. *Bulletin*, 1901, VI:604-607.
- BOULLIER, G. De la préparation de la soupe destinée à remplacer le café au réveil. *Archives de médecine et de Pharmacie militaires*, 1903, XLI:465-473.
- BRILL, HARVEY C. Ipele, a coffee substitute. *The Tea and Coffee Trade Journal*, 1918, XXXV:628-630.
- DERIDDER, H. Sur un succédané du café. *Archives médicales belges*, 1896, 4 ser. VIII:237-241.
- DUCHACEK, F. Beiträge zur Kenntniss der chemischen Zusammensetzung des Kaffees und der

- Kaffee-Ersatzstoffe. Zeitschrift für Untersuchung der Nahrungs- und Genussmittel, 1904, VIII.
- FABER, E. E. Om kaffee, kaffeesurrogater og koffeinfri kaffe. Ugeskrift for Laeger, 1909, LXXI: 841-847.
- GRÄF, H. Ein neues Kaffee-Ersatzmittel. Deutsche medicinische Presse, 1907, XI:65-67.
- GUILLOT, C. Etude comparative sommaire des principaux produits de substitution du café. Gazette médicale de Paris, 1912, LXXXIII: 125.
- HANAUSEK, T. F. Einige Bemerkungen zu den Kapiteln Kaffee und Kaffee-Ersatzstoffe in den Vereinbarungen. Apotheker Zeitung, 1902, XVII:657.
- HANBURY, DANIEL. On the use of coffee leaves in Sumatra. Pharmaceutical Journal, 1853, XIII: 207-209.
- KORNAUTH, C. Beiträge zur chemischen und mikroskopischen Untersuchung des Kaffee und der Kaffeesurrogate. Mittheilungen aus dem pharmaceutischen Institute und Laboratorium für angewandte Chemie der Universität Erlangen, 1890, III:1-56.
- KOTSIN, M. B. Kofe i yevo surrogati. (Coffee and its substitutes.) Vestnik obshestvennoi higieny, sudebnoi i prakticheskoi meditsiny, etc., 1894, XXIII:pt. 2, 36, 156, 226.
- NICOLAI, H. F. Der Kaffee und seine Ersatzmittel. Deutsche Vierteljahrsschrift für öffentliche Gesundheitspflege, 1901, XXXIII:294-346, 502-538.
- NOTTBOHM, F. E. Verwendung von Steinnuss zur Herstellung von Kaffeersatzmitteln. Zeitschrift für Untersuchung der Nahrungs- und Genussmittel, 1913, XXV:pt. 3.
- OELLER and GERLACH, VON. Ueber die Einwirkung von Gerstenkaffee und Malzkaffee auf das Sehorgan. Therapeutische Monatshefte, 1912, XXVI:429-431.
- RAMPOLD. Ueber Kaffeesurrogate. Journal der practischen Heilkunde, 1838, LXXXVII:pt. 4, 94-109.
- RUEDY, J. Thee und Kaffee, deren Surrogate und Fälschungen. Blätter für Gesundheitspflege, 1876, V:183, 195, 203; 1877, VI:19, 32, 42, 53.
- SALE of dandelion coffee. Pharmaceutical Journal, 1860, II:346-348, 357-358, 396.
- STENHOUSE J. On the dried coffee leaf of Sumatra, which is employed in that and some of the adjacent islands as a substitute for tea or for the coffee bean. Pharmaceutical Journal, 1854, XIII:382-384.
- TRILLICH, H. and GOCKEL, H. Beiträge zur Kenntnis des Kaffees und der Kaffeesurrogate. Zeitschrift für Untersuchung der Nahrungs- und Genussmittel, 1898, V:101-106. Also, Forschungs-Berichte über Lebensmittel, 1897, IV: 78; 1898, V:101.
- WEISSMAN. Ueber Kornkaffee. Deutsche medizinische Wochenschrift, 1903, XXIX:20.
- WOODS, C. D. and MERRILL, L. H. Coffee substitutes. Maine Agricultural Experiment Station. Bulletin, LXV:101-116.
- MALT COFFEE
- DOEPMANN, F. Ueber Malzkaffee. Zeitschrift für Untersuchung der Nahrungs- und Genussmittel, 1914, XXVII:453-466.
- JUNGHAHN, A. Beiträge zur Chemie und Technologie des Malzkaffees Verhandlung der Gesellschaft deutscher Naturforscher und Aerzte, 1906, II, pt. 2, 382-386.
- TRILLICH, H. Welche Mindestforderungen sind an Malz für Malzkaffee zu stellen? Zeitschrift für Untersuchung der Nahrungs- und Genussmittel, 1905, X:118-121.
- TAXATION, JURISPRUDENCE, ETC.
- BORDEAUX. CHAMBRE DE COMMERCE. Rapport fait à la Chambre par la Commission spéciale chargée d'étudier la question de la reduction des droits sur les sucres et les cafés. *Bordeaux*, 1858.
- Second rapport fait à la Chambre par la Commission spéciale chargée d'étudier la question de la réduction des droits sur les sucres et les cafés. *Bordeaux*. 1859. 16 pp.
- CORRIE, EDGAR. Letters on the subject of the duties on coffee. *London*, 1808. 61 pp.
- GREAT BRITAIN. STATUTES. Anno regni Georgii III. Regis Quadragesimo nono. Cap. lxi. An act for making sugar and coffee of Martinique and Mariegalante liable to duty on importation as sugar and coffee not of the British plantations. *London*, 1809. pp. 437-438.
- Anno regni Georgii II Regis vicesimo quinto. An act for encouraging the growth of coffee in His Majesty's plantations in America. *London*, 1752. pp. 723-734.
- Anno regni Georgii II Regis quinto. An act for encouraging the growth of coffee in His Majesty's plantations in America. *London*, 1732. pp. 411-415.
- LARRINAGA, TULLIO. Brief of Honorable Tulio Larrinaga, resident commissioner from Porto Rico to the United States of America before the Committee on ways and means. *Washington*, 1908. 9 pp.
- MADRAS. STATUTES. The Madras coffee-stealing prevention act, 1878. *Madras*, 1908. 9 pp.
- NELSON, KNUTE. Export duty on coffee and tea. List of countries levying an export duty on coffee and tea, with statistics from the annual report on commerce and navigation for 1908. *Washington*, 1909. 6 pp. U. S. 61st Congress, 1st session. Senate Document, 120.
- ORDONNANTIE, waar naar in de stad Utrecht en Amersfoort, en in de vryheden van dien, by taxatie zal worden geheven de impost op de koffij, cicers en thee. *Utrecht*, 1767. 6 pp.
- PUERTO RICO. Economy Commission. Vista pública celebrada por la sub-comisión económica 26 de Octubre de 1930, con el fin de oír a los cafeteros de la isla en relación de su petición sobre condonación de contribuciones. *San Juan*, 1930. 72 pp.
- PRODUCE CLEARING HOUSE. Regulations for coffee future delivery. *London*, 1888. 12 pp.
- VAN OOSTERWIJK BRUYN, PIETER ADOLF. Beschouwingen over eene belasting op koffij. *Utrecht*, 1863. 78 pp.
- TRADE AND STATISTICS
- EXCHANGE TABLES
- MÜLLER, VICTOR R. Comparative tables showing the parity of prices of Havre good average and New York coffee exchange standard no. 7. *New York*, 1887. 15 pp.
- SELIGSBERG, LOUIS. Parity tables for quotations of coffee and sugar on the various exchanges of Europe, converted into American currency. *New York*, 1891. 23 pp.
- ZOBEL, PAUL. Paritäts-Tabellen zum Kaffee-Termin-Markt nebst Schnellrechnungs Tabellen, 1907. *Triest*.

## GENERAL

- BELLI, B. Il caffè, il suo paese e la sua importanza. *Milano*, 1910. 395 pp.
- BISIO, G. Il caffè. Le ioni date dal Prof. G. Bizio alla Reale Scuola superiore di commercio, *Venezia*, 1870.
- BROUGIER, A. Der Kaffee, dessen Kultur und Handel, 1897.
- BURNS, JABEZ. The "Spice mill companion": a collection of valuable information, original and selected, suited to the requirements of the present condition of the coffee and spice mill business. *New York*, 1879. 102 pp.
- BYNUM, M. L. International trade in coffee. Department of Commerce, Washington, 1926. Trade Promotion Series no. 37.
- CAFE, EL. Secretaria de la Economia Nacional, *Mexico*, 1933.
- CAFÉ, O. Secretaria da Agricultura, Industria e Commercio, *São Paulo*, 1929.
- COFFEE. Museum of Agriculture, Industry & Commerce. *Rio de Janeiro*, 1928.
- COFFEE STATISTICS, 1932-1933. Published by Crowther & Goodman. *London*, 1933.
- DOWLER, J. S. O. & Co. Coffee calculator. *Saint Louis*, 1907. 31 pp.
- FERGUSON, J. Production of tea and coffee in British dependencies. *London*, 1896. 1 p.
- FÜRST, MAX. Die Börse, ihre Entstehung und Entwicklung, ihre Einrichtung und ihre Geschäfte. Die Welthandelsgüter Getreide, Kaffee, Zucker. *Leipzig*, 1913.
- HIRSCHMANN, AUGUST. Die Kaffee-Weltwirtschaft in ihrer neueren Entwicklung. *Marburg*, 1930. 199 pp.
- INTERNATIONAL BUREAU OF THE AMERICAN REPUBLICS. Coffee. Extensive information and statistics. *Washington*, 1901. 108 pp. Also, in Spanish.
- Coffee. Reprint of an article from the Monthly Bulletin of the International Bureau of American Republics, Nov., 1908. *Washington*, 1909. 11 pp.
- INTERNATIONAL INSTITUTE OF AGRICULTURE. BUREAU OF STATISTICS. Stocks visibles de froment et farine de froment, de sucre, de café, de coton et de soie; 1903-12. *Rome*, 1914. 79 pp.
- METROPOLITAN LIFE INSURANCE Co. Adjustment of operations by coffee roasters to changing conditions. *New York*, 1931.
- PHILIPS, ROSA. De invloed van de Braziliaansche koffie-verdedigings-politiek op de koffie-importen der hoofdconsumptielanden. *Haarlem*, 1934. 131 pp.
- RETAIL market for coffee, The. Associated Coffee Industries of America. *New York*, 1932.
- ROTH, HANS. Die übererzeugung in der Welthandelsware Kaffee im Zeitraum von 1790-1929. *Jena*, 1929.
- SCHMEDDING, J. H. F. and ZONEN. Coffee. Statistics running from 1884-1905. *Amsterdam*, 1901. 18 pp.
- SCHÖFFER, C. H. The coffee trade. *New York*, 1869. 58 pp.
- UNITED STATES. BUREAU OF FOREIGN COMMERCE. Verslagen betreffende de cultuur en de bereiding van koffie en het keplante en nog beschikbare terrein voor dit product in Mexico, Centraal- & Zuid-America en West-Indië. *Amsterdam*, 1889. 135 pp. In English, except introduction. Reprinted from Reports from the consuls of the United States, 1888, XXVIII, no. 98.
- UNITED STATES. STATISTICS BUREAU. The world's production and consumption of coffee, tea and cacao in 1905. *Washington*, 1905. 206 pp. Reprinted from Monthly Summary of Commerce and Finance, July, 1905.
- VAN DELDEN LAERNE, C. F. Brazil and Java. Report on coffee-culture in America, Asia and Africa, to H. E. the Minister of the Colonies. *London*, 1885. 637 pp.
- VILLARES, JORGE DUMONT. O café, sua produção e exportação (Part I); O café cultura, produção e commercio (Part II). *São Paulo*, 1927.
- WORLD'S exports of coffee. Department of Commerce, *Washington*, 1930. Trade Promotion Series no. 37.

## Periodicals

- BACHE, L. S. How the exchange works. The Tea and Coffee Trade Journal, 1921, XLI:678-682.
- BRAND, CARL W. Co-operative competition. The Tea and Coffee Trade Journal, 1914, XXVII:534-540.
- CALVO, J. B. and DELFINO, A. E. Commission for the study of the production, distribution and consumption of coffee. International Bureau of American Republics Monthly Bulletin, 1902, XIII:1317-1321.
- CHEVALIER, AUG. Situation actuelle de la production et de la consommation du café dans le monde. Revue de Botanique Appliquée et d'Agriculture Tropicale, Aug. 1932:641-642.
- COFFEE. Statist., 1915, LXXXIII:377-378.
- COFFEE and coffee trade. Hunt's Merchant's Magazine, XXVII:39; XLI:165.
- COFFEE trade. Leisure Hour, XXIX:357.
- COTTON-COFFEE quotation record. Monthly. N. Y.
- CRAWFORD, J. History of coffee. Journal of the Statistical Society, XV:50.
- DEVELOPMENT of coffee production in the Empire, The. Bulletin of the Imperial Institute, 1933, XXXI, 4:507-529.
- DUKE, J. S. Coffee trade. De Bow's Commercial Review, II:303. Hunt's Merchant's Magazine, 1850, XXIII:59, 172, 451.
- EL CAFETAL, revista oficial mensual dedicada exclusivamente a la industria cafetera en todos su ramos. *New York*, 1903.
- FEDERAL REPORTER, for planters, grocers, confectioners, canners and dealers in coffee, tea and spice. *New York*. Current monthly.
- GARDNER, J. Coffee trade. Western Journal and Civilian, VII:301. Also, Hunt's Merchant's Magazine, XIII:273; J. Gardner Hunt's Merchant's Magazine, XXV:690; Living Age, XXVII:254.
- Production and consumption of coffee. Hunt's Merchant's Magazine, XXIV:194.
- GILL, W. K. Meeting coffee competition. The Tea and Coffee Trade Journal, 1916, XXXI:238-239.
- GONZALEZ-ZELEDON, MANUEL. The coffee industry. Commercial Pan America, 1934, XXVIII:1-11.
- GRAHAM, HARRY CRUSEN. Coffee. Production, trade, and consumption by countries. U. S. Dept. of Agriculture. Bureau of Statistics. Bulletin, 1912, LXXIX. 134 pp.
- GREAT BRITAIN. COMMERCIAL, LABOUR AND STATISTICAL DEPT. Tea and coffee. Statement "showing the imports of tea and coffee into the principal countries of Europe and into the United States: together with statistical tables

- relating thereto for recent years as far as the particulars can be stated." 1884-1900. House of Commons, paper 351, 1900. 27 pp. House of Commons paper 363, 1902. 42 pp.
- HANGWITZ, JULIAN. The world's coffee trade in 1898. Consular Reports, 1899, LX:258-261.
- HARRIS, WILLIAM B. Coffee and the law. Tea and Coffee Trade Journal, 1912, XXIII; Supplement to no. 6:41-44.
- HEILPRIN, M. History of coffee. Nation, VI:275.
- HOLLAND, T. H. Robusta coffees and their commercial possibilities. The Tropical Agriculturist, 1930, LXXV, 5:304-307.
- HUEBNER, G. G. Coffee market. Annals of the American Academy, 1911, XXXVIII:610-620.
- INTERNATIONAL BUREAU OF THE AMERICAN REPUBLICS. Bulletin. Washington, 1893—date. Contains from time to time articles on coffee production in the various Latin-American countries.
- KAFFEE verbrauch in den hauptsächlichsten Ländern der Welt. Deutsche Handels-Archiv, 1901, 206-207.
- LECOMTE, H. La culture du café dans le monde. La Géographie, 1901, III:471-488. Also, in Finnish. Geografiska Föreningens Tidskr., 1901, XIII:252-272.
- LEECH, C. J., & Co. Table of coffee statistics. Annual. London.
- LEHY, GEOFFREY B. Coffee distribution. The Tea and Coffee Trade Journal, 1913, XXV:564-566.
- LEWIS, E. ST. ELMO. Promoting coffee sales. The Tea and Coffee Trade Journal, 1915, XXIX:539-544.
- MAHIN, JOHN LEE. Advertising coffee. The Tea and Coffee Trade Journal, 1912, XXIII:56-58.
- MATHEWS, FREDERICK C. Coffee advertising efficiency. The Tea and Coffee Trade Journal, 1912, XXIII:38-40.
- MCCREERY, R. W. The penny-change system. The Tea and Coffee Trade Journal, 1911, XXI:462-464.
- MACFARLANE, JOHN J. Coffee and tea statistics. The Tea and Coffee Trade Journal, 1916, XXXI:329-333.
- MERRITT, E. A. The world's coffee. U. S. Consul's report on commerce, 1883, no. 31, 125-147.
- NEW YORK. COFFEE EXCHANGE. Report. Annual. New York.
- OUR coffee industry. Scientific American Supplement, 1902, LIII:21994.
- PRICE, import, and consumption of coffee. De Bow's Commercial Review, XX:253.
- THE SPICE MILL; devoted to the interests of the coffee, tea and spice trades. Monthly. New York.
- TEA and Coffee consumption. Current Literature, 1901, XXX:298.
- TEA AND COFFEE TRADE JOURNAL, THE. For the tea, coffee, spice and fine grocery trades. Monthly. New York.
- UKERS, WILLIAM H. Advertising Brazil coffee. Tea and Coffee Trade Journal, 1917, XXXII:34-36.
- The right coffee propaganda. Tea and Coffee Trade Journal, 1912, XXIII. Supplement to no. 6:21-28.
- Twenty-five years of tea and coffee. Tea and Coffee Trade Journal, 1926, LI:299-314.
- Coffee. Svenska Handelsbanken Index, April 1932, no. 76, VII.
- UKERS TEA AND COFFEE BUYER'S GUIDE, William H. Ukers, editor. Bi-annual. New York.
- UNITED STATES. STATE DEPARTMENT. Production and consumption of coffee, etc. Message from the president of the United States, transmitting a report from the secretary of state, with accompanying papers, relative to the proceedings of the International Congress for the Study of the Production and Consumption of Coffee, etc. Dec. 10, 1902. U. S. 57th Congress, 2nd session. Senate document 35. 312 pp.
- VASCO, G. Le café. Revue française de l'étranger et des colonies et exploration, 1900, XXV:598-603.
- WEIR, ROSS W. Coffee hints for grocers. The Tea and Coffee Trade Journal, 1913, XXV:566-568.
- WESTERFELD, SOL. Retailers' coffee problems. The Tea and Coffee Trade Journal, 1917, XXXIII:559-560.
- WORLD'S coffee trade. The Tea and Coffee Trade Journal, 1919, XXXVI:129-130.

## REGIONAL

## BRAZIL

- ALVES DE LIMA, J. C. Soluções sobre o commercio de café. São Paulo, 1902. 38 pp.
- BOLLE, KARL. São Paulo das bedeutendste Kaffeegebiet der Welt. Deutsche Rundschau für Geographie, XXVIII:66-77.
- BRAZIL. MINISTERIO DE FAZENDA. Direitos de exportação e sua cobrança. Rio de Janeiro, 1895. 11 pp.
- BRAZIL. SERVIÇO DE ESTATISTICA COMMERCIAL. Statistics of imports and exports. The movement of shipping, exchange and coffee in the republic of the United States of Brazil. (Yearly.) Rio de Janeiro.
- BRAZIL and coffee; souvenir of the Louisiana purchase exposition. 1904. 28 pp.
- BRAZIL coffee in England. Bulletin of the Pan American Union, 1915, XL:514-515.
- BRAZIL, 1932. Commercial Service of the Ministry of Foreign Affairs. Rio de Janeiro, 1932.
- BRAZILIAN coffee propaganda, The. Commercial and Financial Chronicle, 1909, LXXXVIII:1223-1224.
- BRAZILIAN REVIEW, The: a weekly record of trade and finance. Rio de Janeiro, 1907-1914.
- BURTON, H. La defense permanente du café au Bresil. Revue économique internationale, 1930, XXII, no. 4:121-151.
- COFFEE crop of Brazil, The. Economist, 1909, LXVIII:1030-1031.
- COFFEE exports from Brazil, 1898-1900. Monthly Summary of Commerce and Finance, 1900-1901: 2592-2593.
- D'ANTHOUARD DE WASSEERVAAS, A. Le café au Brésil. Journal des Economistes, 1910, ser. 6, XXVII:16-37.
- DA SILVA TELLES, A. O café e o estado de São Paulo. São Paulo, 1900. 60 pp.
- EMPIRE of Brazil at the World's industrial and cotton centennial exposition of New Orleans, The. New York, 1885. 71 pp.
- ERBER, ROBERTO. La politica del Brasile nei riguardi del caffè. Rome, 1931.
- GREAT BRITAIN. FOREIGN OFFICE. BRAZIL. Résumé of a report published in the "Jornal do Comercio" of Rio de Janeiro on the production of coffee in Brazil, with statistics respecting its consumption in the United States. London, 1899.

- 7 pp. Diplomatic and Consular Reports, Miscellaneous series, no. 512.
- GROSSI, VINCENZO. La crisi del caffè e i progetti per la fissazione del cambio al Brasile. Nuova Antologia, CCVIII; (ser. 5, CXXIV): 484-494.
- KAFFEEFRAGE in Brasilien, Die. Grenzboten, LXVI: 335-339.
- LEROY-BEAULIEU, PAUL. Les droits sur le café. Le Brésil, la France et nos colonies. L'Economiste français, XXVIII; no. 1:101-103.
- MCCREERY, W. G. and BYNUM, MARY L. Coffee industry in Brazil. U. S. Department of Commerce, Washington, 1930. Trade Promotion Series no. 92.
- MEDEIROS, SEBASTIÃO. Problemas do café. São Paulo, 1930.
- MOREIRA, NICOLAU JOAQUIM. Brazilian coffee. New York, 1876. 11 pp.
- N. Lettres du Brésil. La question du café. L'Economiste français, XXVIII, no. 1:374-377.
- PATERSON, W. MORRISON. Brazil's coffee trade of to-day. The Tea and Coffee Trade Journal, 1918, XXXV:323-324.
- PINTO, ADOLPHO AUGUSTO. The state of São Paulo. Chicago, 1893. 14 pp.
- REGRAY, L. Coffee overproduction analysed. Tea and Coffee Trade Journal, 1931, LX, 4:387-395. —Brasil Café 1934. Paris, 1934.
- REID, WILLIAM ALFRED. Coffee; brief facts about a great Brazil industry. Washington, 1928. Pan American Union Commodities Series no. 17.
- ROWE, J. F. W. Studies in the artificial control of raw material supplies, no. 3, Brazilian coffee. Executive Committee of London & Cambridge Economic Service. London, 1932.
- SÃO PAULO (state) BRAZIL. SECRETARIA DE COMERCIO SE OBRAS PUBLICAS. Estatística especial da lavoura de café nos municípios de Aracari-guama, Atibaia, Bananal, Pilar, Sertãozinho e Redenção. São Paulo, 1900. 33 pp. Supplemento do Boletim da Agricultura, 1900, ser. 1:VI.
- Estatística especial da lavoura de café nos municípios de Apiaty, Batates, Caconde, Campos Novos do Paranapanema, Dourado, Fartura, Faxina, Itarare, Jaboticabal, Mocóca, Monte-Mór, Natividade, Nazareth, Pirassununga, Porto-Feliz, Remedios da Ponte do Tieté, São Pedro do Turvo, Sarapuí, Serra Negra e Yporanga. São Paulo, 1901. 177 pp. Supplemento do Boletim da Agricultura, 1901, ser. 2:IV.
- SEGER, EUGENE. Coffee crop of Brazil. U. S. Consular Reports, 1898, LVII, no. 218:334-336.
- "SPECTATOR." Paper money and coffee. Rio de Janeiro, 1931. 18 pp.
- TRANSPORTING Brazil coffee. Tea and Coffee Trade Journal, 1917, XXXIII:214-224.
- WARD, ROBERT DE C. A visit to the Brazilian coffee country. National Geographic Magazine, 1911, XXII:908-931.
- WILLIAMS, J. H. The Brazil coffee situation. The Tea and Coffee Trade Journal, 1918, XXXV: 221-222.
- WINDELS, J. H. A coffee buyer's life in Brazil. Tea and Coffee Trade Journal, 1916, XXX.
- COLOMBIA
- BELL, P. L. Coffee, the mainstay of Colombia. Tea and Coffee Trade Journal, 1922, XLII:164-174.
- COFFEE industry in Colombia, The. U. S. Department of Commerce, Washington, 1931. Trade Promotion Series no. 127.
- DICKSON, SPENCER S. Colombia. Report on the coffee trade of Colombia. London, 1903. 8 pp. Great Britain. Foreign Office. Diplomatic and Consular Reports, Miscellaneous series, no. 598.
- KARLSTROM, GUNNAR. Colombia as a coffee land. Tea and Coffee Trade Journal, 1926, L:163-166.
- MANUEL DEL CAFETERO COLOMBIANO. Published by the Federacion Nacional de Cafeteros, Bogota, 1932.
- MONSALVE, DIEGO. Colombia cafetera; información histórica, política, civil, administrativa, geográfica, etnográfica, fiscal, económica, bancaria, postal . . . y general. Barcelona, 1927.
- VALDERRAMA BENITEZ, ERNESTO. La industria cafetera santandereana. Estudio. 1933, II: 270-274.
- COSTA RICA
- COSTA RICA. CONTABILIDAD NACIONAL. Exportación de la cosecha de café.
- COSTA RICA. DEPARTAMENTO NACIONAL DE ESTADÍSTICA. Diagrams de los promedios obtenidos en la venta del café de Costa Rica en Londres en los años de 1890 a 1899. San José, 1900.
- Exportaciones de café de la República de Costa Rica. San José, 1900. 14 pp. Alcance a La Gaceta, 1900, no. 99.
- Fluctuaciones de los precios del café en Hamburgo, 1880-1899. San José, 1900.
- COSTA RICA. SECRETARIA DE RELACIONES EXTERIORES. Estudio é informe sobre el café de Costa Rica. 1900. 48 pp.
- EAST INDIES
- DEKKER, EDUARD DOUWES. Max Havelaar; or The coffee auctions of the Dutch Trading Company; by Multahuli, (pseud.); trans. from the original ms. by Baron Alphonse Nahuijs. Edinburgh, 1868.
- TERGAST, G. C. W. Chr. Monographie over de bevolingskoffiecultuur in Nederlandsch-Indië. Landbouwvoorlichtingsdienst Mededeeling, 1930, XV:1-48.
- VERWANGING van de gedwongen koffieteelt door eene vrije volkskoffiecultuur. Tijdschrift voor Nederlandsch-Indie new ser. 2, V:252-261.
- EL SALVADOR
- CAFÉ de El Salvador, EL Revista de la Asociación Cafetalera de El Salvador. San Salvador, 1930.
- FINLAND
- GRANWROTH, ELIAS G. Om cafe och de inhemska växter, som pläga brukas i dess ställe. Abo, 1755. 18 pp.
- FRANCE
- ARREST DU CONSEIL D'ESTAT DU ROY, qui permet aux directeurs interessez en l'armement du vaisseaux la Paix, de vendre les balles de café dont il est chargé. Paris, 1720. 4 pp.
- Qui accorde à la Compagnie des Indes le privilege exclusif de la vente du café. Paris, 1723. 4 pp.
- Pour la prise de possession par la Compagnie des Indes du privilege de la vente exclusive du café, sous le nom de Pierre le Sueur. Paris, 1723. 7 pp.
- Qui ordonne que les commis et employez de la Compagnie des Indes pour l'exploitation des



- privileges du tabac et du café, procederont aux visites et executions au sujet des toiles et etoffes et Indes et du Levant. *Paris*, 1723. 7 pp.
- Que declare commune en faveur des habitans de Cayenne et de St. Domingue, la declaration du 27. Septembre 1735. *Paris*, 1735. 3 pp.
- Portant reglement sur les cafez provenant des plantations et cultures des Isles Françoises de l'Amerique. *Paris*, 1736. 4 pp.
- CAFÉ, EL, *Paris*, 1926 (?). Les monographies de la Dépêche coloniale.
- DAROLLES, E. Le café sur le marché française. *Paris*, 1885.
- DECLARATION DU ROY, Qui regle la manière dont la Compagnie des Indes fera l'exploitation de la vente exclusive du café. Donnée à Versailles le 10. Octobre 1723. *Paris*, 1723. 15 pp.
- Concernant les cafez provenant des plantations et culture de la Martinique et autres Isles Françoises de l'Amerique. Donnée à Fontainebleau le 27. Septembre 1732. *Paris*, 1732. 9 pp.

## FRENCH INDO-CHINA

- CARDOT, J. and BRAEMER, P. Les principaux produits d'exportation de l'Indochine. Publications de l'Agence Economique, *Paris*, 1931, no. XXVIII. Coffee on pp. 32-38.

## GERMANY

- FREYTAG, GUNTHER. Die Usancen im Hamburger Kaffeehandel. *Erlangen*, 1929. 59 pp.
- SCHÖNFELD, KARL. Der Kaffee-Engrosshandel Hamburgs. *Heidelberg*, 1903. 135 pp.

## GREAT BRITAIN

- ALLONCIUS, C. J. Mincing-Lane (Centre du marché du café de Londres). Association pour le Perfectionnement du Matériel Colonial, Aug. 1932:318-342.
- GREAT BRITAIN. BOARD OF TRADE. Tea and coffee, 1888, 1893, 1899-1900, 1903, 1908, 1910. Statistical tables showing the consumption of tea and coffee in the principal countries of Europe, in the United States and in the principal British self-government dominions, and also showing the principal sources of supply. Parliament, House of Commons. Reports and papers, 1889, no. 12; 1894, no. 329; 1900, no. 351; 1901, no. 363; 1903, no. 304 (reprinted, London, 1905, 47 pp.); 1908, no. 378 (reprinted, London, 1911, 53 pp.); 1911, no. 275 (reprinted, London, 1911, 19 pp.).
- GREAT BRITAIN. TREASURY DEPARTMENT. Copy of diagrams showing the consumption from 1856 to 1888 of tea, coffee, cocoa, and chicory, of alcoholic beverages, and of tobacco, compared with the increase of population. *London*, 1889. House of Commons, paper 121.
- LIFEBELT COFFEE COMPANY, LTD. The statutory meeting of the company. *London*, 1909, 2 pp.
- OBERPARLEITER, K. Der Londener Kaffeemarkt. 1912.

## GULIANA, DUTCH

- ROEF-PRAATJE, tusschen verscheiden personen, over de tegenswoordige staat van Surinamen en de laage prys der producten; waarin klaar aangetoond word de verkeerde gewoontens, wegens het verkoopen der coffy by inschryving, tot merkelyk nadeel der houders en geïntresseerdens der Surinaamsche obligaties. *Amsterdam*, 1774. 175 pp.

## HAITI

- MARTIN, ROBERT F. Improvement for Haiti coffee industry. *Tea and Coffee Trade Journal*, Sept. 1929, LVII:288-294.
- Two HUNDRED years of coffee in Haiti. *Tea and Coffee Trade Journal*, 1935., LXVIII:102-105.

## HAWAII

- HAWAII (Republic) LABOR COMMISSION. Report on the coffee industry. *Honolulu*, 1895. 33 pp.
- HAWAIIAN ISLANDS. DEPARTMENT OF FOREIGN AFFAIRS. The Hawaiian Islands, their resources, agricultural, commercial and financial. Coffee, the coming staple product. *Honolulu*, 1896. 95 pp. Also, *Washington*, 1897. 32 pp.

## INDIA

- CLIFFORD, FREDERICK. Indian coffee: its present production and future prospects. *Journal of the Society of Arts*, 1887, XXXV:519-534.
- INDIA. COMMERCIAL INTELLIGENCE DEPARTMENT. Note on the production of coffee in India.
- INDIA. STATISTICAL DEPARTMENT. Production of coffee in India. 19—.
- MEMMINGER, LUCIEN. The Indian coffee trade crisis. *The Tea and Coffee Trade Journal*, 1917. XXXII:506-510.
- SCHUURMAN, G. E. Eenige beschouwingen over verkoop van gouvernementen koffie in India. *Rotterdam*, 1877. 13 pp.

## JAVA

- KAMERWIJSHEID (Relating to forced native labor in the island of Java) 1879. 31 pp. Reprint from *Algemeen Dagblad van Nederlandsche Indië*, Sept. 16, 18, 22, 24, 25, 1879.
- DE KOFFIECULTUUR op Java. *Tijdschrift voor Nederlandsche Indië*, new ser. 2, no. 5:660-667.
- KUNEMAN, J. De gouvernementen koffie-cultuur op Java. 's *Gravenhage*, 1890. 201 pp.
- ROSE, G. F. C. Eenge opmerkingen naar aanleiding van de conclusie van de neederheid der commissie nit de Tweede Kamer der Staten-Generaal over de nitkomsten van het onderzoek betreffende de koffij cultuur op Java. 1874. 39 pp.
- SUERMONDT, G., and LONDON, H. H. Correspondentie. De West-Java-Koffij-Cultuur-Maatschappij verdedigd tegen den schrijver van de koloniale kronijk in de *Economist*. 1868. 15 pp.
- West-Java-Koffij-Cultuur-Maatschappij verdedigd tegen de aanvallen van *Volksblad en Arnheemsche Courant*. *Amsterdam*, 1865. 44 pp.
- West-Java-Koffij-Cultuur-Maatschappij. Toegelicht. Supplement van den eersten druk met voorrede. *Amsterdam*, 1865. 19 pp.
- VAN DEN BERG, NOBBERT PIETER. Koffieproductie en koffieuitvoer. *Batavia*, 1884. 8 pp.
- VAN VLIET, L. VAN W. De koffij-enquê in verband met de ontworpen West-Java-Koffij-Cultuur-Maatschappij. *Amsterdam*, 1871. 35 pp.

## KENYA

- TRENCH, A. D. The coffee industry of Kenya Colony. Department of Agriculture, Kenya, 1928. Bulletin 19.

## LIBERIA

- ELLIS, GEORGE W. Coffee industry in Liberia. U. S. Monthly Consular and Trade Reports, 1904, no. 291:21-22.

MORREN, F. W. Cultuur bereiding en handel van Liberia Koffie. *Amsterdam*, 1894. 36 pp.

## MEXICO

CAFÉ, EL. Secretaria de la Economia Nacional, *Mexico*, 1933.

HINOJOSA, G. Cultivo del café. *Mexico*, 1883. 8 pp. (Mexico. Ministro de Fomento.)

ROMERO, M. Coffee and india rubber culture in Mexico; preceded by geographical and statistical notes on Mexico. *New York*, 1898. 416 pp.

TERRY, L. M. Coffee culture in Mexico. *Overland Monthly*, 1901, new ser. XXXVII:702-709.

## NETHERLANDS

AMSTERDAM. VEREENIGING VOOR DEN KOFFIEHANDEL. Statistiek van koffie in Nederland. *Amsterdam*, 1914.

GROENEVELD, J. Tremijnzaken in koffie te Rotterdam. *Rotterdam*, 1893. 15 pp.

JACOBSON, J. "Ernstig bedreigd" "Opgeroepen," een woord naar aanleiding van "Erustig bedreigd" door den heer J. Jacobson en de daarop gevolgde geschriften van de heeren G. H. Mees en A. Plate, door en Nederlandes. *Amsterdam*, 1879. 12 pp.

JETS over de koffij-veilingen der Nederlandsche Handel-Maatschappij. *Rotterdam*, 1847. 24 pp.

NETHERLANDS (KINGDOM) Laws, statutes, etc. Wij Willem, bij de gratie Gods, konig der Nederlanden . . . enz., enz., enz. Allen den genen, die deze zullen zien. . . salut! doen te weten: Alzoo wij, tot stijving der inkomsten van den staat, noodzakelijk geoordeeld hebben, dat de koffij binnen ons rijk gebruikt . . . aan eene belasting op de consumptie worde onderworpen. 's *Gravenhage*, 18—. 8 pp.

SUERMONT, G., and LONDON, H. H. West-Java-koffij-Cultuur-Maatschappij. Het advys der Kamer van Koophandel te Batavia, de Ond Koopman, enz. wederlegd. *Amsterdam*, 1866. 127 pp.

WAANDERS, F. G. van B. De koffiemarkt. *The Hague*, 1882. 27 pp.

## PUERTO RICO

DEGOLIA, DARWIN. Puerto Rico's coffee industry and trade. *Tea and Coffee Trade Journal*, 1932, LXIII:118-122.

FIGUEROA, C. A. El problema cafetera de Puerto Rico. *San Juan*, 1923.

PORTO RICAN coffee. *Outlook*, Mar. 24, 1906, LXXXII:632; May 5, 1906, LXXXIII:46-47.

UNITED STATES. PRESIDENT, 1901-1909 (ROOSEVELT). Message from the President of the United States relative to his visit to the island of Porto Rico. *Washington*, 1906. 200 pp. 59th Congress, 2d Session, Senate document 135. Message, dated Dec. 11, 1906, accompanied by petitions in relation to the coffee trade, etc., and losses by the hurricane of 1899; and the sixth annual report of the governor, Beekman Winthrop, dated July 1, 1906.

VAN LEENHOFF, JOHANNES W. The condition of the coffee industry in Porto Rico. *Mayaguez*, 1904. 2 pp. Porto Rico Agricultural Experiment Station. Circular no. 2.

WEYL, W. E. Labor conditions in Porto Rico. U. S. Bureau of Labor. *Bulletin*, 1905, XI:749-753.

## SPAIN

SPANIEN. Bestimmungen über die Einfuhr von Kaffee und Kakao aus Fernando Po. *Deutsche Handels-Archiv*, 1901. 141.

## TONKIN

EXPERIENCES au Tonkin sur le caféier et le théier. *Bulletin de l'Agence Economique de l'Indochine*. June 1933:218-220.

ROTTAET, EDMOND. L'organisation économique de l'Indochine et le café au Tonkin. *Société de Géographie commerciale de Paris. Bulletin*, 1913, XXXV:643-660.

## UNITED STATES

AMERICAN tea and coffee trade from 1847 to 1916. *Tea and Coffee Trade Journal*, 1917, XXXIII:28.

COFFEE EXCHANGE OF THE CITY OF NEW YORK. Annual Report.

COFFEE trade of the United States. Chamber of Commerce, *New York*. Annual Report 1908-1909, pt. 1:23-29.

COFFEE Trade of the United States for the past six years. *Tea and Coffee Trade Journal*, 1917, XXXIII:326-329.

COFFEE TRADE of the United States since 1821. *Tea and Coffee Trade Journal*, 1918, XXXIV:336-338.

CUNNINGHAM, E. S. Export of Mocha coffee to the United States. U. S. Consular Reports, 1899, LXI:625-628.

OUR fastest growing coffee port, including handling green coffee at San Francisco. *The Tea and Coffee Trade Journal*, 1918, XXXIV:524-528.

RENAISSANCE of tea and coffee. *The Tea and Coffee Trade Journal*, 1919, XXXVI:218-229.

SLOSS, R. New York coffee party. *Everybody's Magazine*. 1913, XXVIII:772-783.

TEA, coffee, wines, etc; consumption of tea, coffee, wines, distilled spirits, and malt liquors in the U. S. since 1870, per capita of population. *Washington* 1896-1899. U. S. Agriculture Dept. Yearbook, 1895:552; 1896:595; 1897:754; 1898:723.

UNITED STATES. BUREAU OF STATISTICS. Imports of coffee and tea. 1790-1896. *Washington*, 1896. Also, *Monthly Summary of Finance and Commerce*, 1896, new ser. IV:670-690.

WAKEMAN, ABRAM. History and reminiscences of lower Wall St. and vicinity. *New York*, 1914. 216 pp.

## VALORIZATION

ALTSCHUD, F. Die Kaffeevalorisation. *Jahrbuch für Gesetzgebung*, 1910, 2.

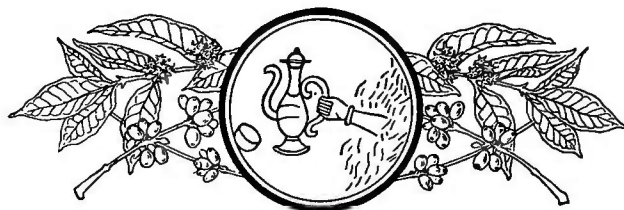
ATTACKING Brazil's coffee trust. *Literary Digest*, 1912, XLIV:1242-1244.

BRAZIL's failure to control the price. *American Geographic Society. Bulletin*, 1909, XLI:220-222.

CAMPISTA, DAVID. Valorisação do café e Caixa de conversão. *Rio de Janeiro*, 1906:53.

CHANTLAND, WILLIAM T. Valorization of coffee. A detailed report of the transactions and facts relating to the valorization of coffee. *Washington*, 1913. 15 pp. U. S. 63rd Congress, 1st session. Senate Document, 36.

- COFFEE combine at bay. *Tea and Coffee Trade Journal*, 1912, XXII:497-513.
- COFFEE valorization and the Sherman law. *Journal of Political Economy*, 1913, XXI:162-163.
- COFFEE valorization scheme and the coming harvest, *The Economist*, 1909, LXVIII:910-911.
- DE CARVALHO, J. C. O café do Brazil, estudos a favor da propaganda para a augmento do consumo e valorisação do café do Brazil no estrangeiro. *Rio de Janeiro*, 1901. 41 pp.
- O café, sua historia, des valorisação e propaganda para o augmento do consumo na Europa o algodão, a industria da tecelagem do algodão, sua origem, apparecimento e desenvolvimento na America do Sul. Conferencias publicas realissadas na sede la Sociedade nacional de agricultura. *Rio de Janeiro*, 1900. 53 pp.
- DENIS, PIERRE. La crise du café au Brésil et la valorisation. *Revue politique et parlementaire*, 1908, LVI:494-520.
- FERREIRA RANGEL, SYLVIO. Valorisação de café. *Rio de Janeiro*, 1906. 18 pp.
- FERRIN, A. W. Brazilian plan of limiting shipments. *Moody's Magazine*, 1912, XIII:409-414. How the coffee trust has held its grip. *Current Literature*, 1912, LIII:52-54.
- HUEBNER, G. G. Making green coffee prices. *Tea and Coffee Trade Journal*, 1912, XXI:442-449.
- HUTCHINSON, LINCOLN. Coffee valorization in Brazil. *Quarterly Journal of Economics*, 1909, XXIII:528-535.
- KURTH, HERMANN. Die Lage des Kaffeemarktes und die Kaffeevalorisation. Inaugural dissertation, *Jena*, 1907. 34 pp.
- LALIÈRE, A. La valorisation du café. *Revue économique internationale*, Feb. 15-20, 1910, VII, pt. 1:316-350.
- LÉVY, MAURICE. La valorisation du café au Brésil. *Annales des Sciences politiques*, 1908, XXIII.
- LUECKER, ALBERT. Neue Probleme in der Frage der brasilianischen Kaffeevalorisation. *Krefeld*, 1925.
- MACFARLANE, JOHN J. Coffee valorization analysed. *Tea and Coffee Trade Journal*, 1910, XIX:103-110.
- MCKENNA, W. E. Cause of advance in price. *Public*, 1912, XV:508.
- OLAVARRÍA, I. A. Liga de los paises cafeteros. *Caracas*, 1898. 20 pp.
- PAYEN, EDOUARD. Au Brésil: la valorisation du café. Questions diplomatique et coloniales, XXIV: 728-740.
- RAISING prices by destruction. *Nation*, 1909, LXXXVIII:520-521.
- RAMOS, F. FERREIRA. La valorisation du café au Brésil. 1907.
- RATZKA-ERNST, CLARA. Welthandelsartikel und ihre Preise. Eine Studie zur Preisbewegung und Preisbildung. Der Zucker, der Kaffee und die Baumwolle. *München*, 1912. 244 pp.
- REGRAY, LEON. Bilan de protection agricole café, 1933. *Paris*, 1932.
- SCHMIDT, FRITZ. Die Kaffeevalorisation. *Jahrbücher für Nationalökonomie und Statistik*, 1909, ser. 3, XXXVIII: 662-670.
- SCHURZ, WILLIAM L. Valorization of Brazil coffee. *Washington*, 1922.
- SIELCKEN, HERMANN. Coffee valorization explained. *Tea and Coffee Trade Journal*, 1911, XXI: 471-481.
- A defense of valorization. *Tea and Coffee Trade Journal*, 1912, XXIII, Supplement to no. 6: 17-21.
- SLOSS, R. Why coffee costs twice as much. *World's Work*, 1912, XXIV: 194-205.
- STOFFREGEN, ELIZABETH. A history of Brazil coffee control. *The Tea and Coffee Trade Journal*, 1928 and 1929, LV:555-557, 744-751; LVI:120-127.
- SUIT against the coffee trust. *Nation*, 1912, XCIV: 508-509.
- SYNDICAT général de défense du café et des produits coloniaux. *Bulletin, Paris*, 1911, II: No. 6.
- THEISS, LEWIS EDWIN. Why the price of coffee increases. Showing how a few rich men, who want to be richer, are pushing up the price of coffee. *Pearson's Magazine*, 1911, XXVI: 456-463.
- TURMANN, MAX. Un état qui fait du commerce. Le Brésil et la valorisation du café. *La Revue hebdomadaire*, 1909, VIII: 450-470.
- UKERS, WILLIAM H. The great coffee corner. *Saturday Evening Post*, 1909, CLXXXI: 5-7.
- VALORIZING coffee. *Review of Reviews*, 1912, XLVI: 21-22.
- VALUE of coffee. *Current Literature*, 1903, XXXV: 746-747.
- WESSELS, L. De opheffing van het monopolie en de vervanging van de gedwongen koffiecultuur op Java door een staatscultuur in vrijen arbeid. *'s Gravenhage*, 1890. 72 pp.
- WILEMAN, J. P. Unparalleled valorization. *Tea and Coffee Trade Journal*, 1911, XX: 444-445.
- ZUR Frage der Kaffee-Valorisation. *Deutsche Wirtschafts-Zeitung*, 1913, IX: 237-243.



# A COFFEE THESAURUS

## *Encomiums and Descriptive Phrases Applied to the Plant, the Berry, and the Beverage*

### *The Plant*

The precious plant  
This friendly plant  
Mocha's happy tree  
The gift of Heaven  
The plant with the jessamine-like flowers  
The most exquisite perfume of Araby the blest  
Given to the human race by the gift of the Gods

### *The Berry*

The magic bean  
The divine fruit  
Fragrant berries  
Rich, royal berry  
Voluptuous berry  
The precious berry  
The healthful bean  
The Heavenly berry  
The marvelous berry  
This all-healing berry  
Yemen's fragrant berry  
The little aromatic berry  
Little brown Arabian berry  
Thought-inspiring bean of Arabia  
The smoking, ardent beans Aleppo sends  
That wild fruit which gives so beloved a drink

### *The Beverage*

Nepenthe  
Festive cup  
Juice divine  
Nectar divine  
Ruddy mocha  
A man's drink  
Lovable liquor  
Delicious mocha  
The magic drink  
This rich cordial  
Its stream divine  
The family drink  
The festive drink  
Coffee is our gold  
Nectar of all men  
The golden mocha  
This sweet nectar  
Celestial ambrosia  
The friendly drink  
The cheerful drink  
The essential drink  
The sweet draught  
The divine draught  
The grateful liquor  
The universal drink  
The American drink  
The amber beverage

The convivial drink  
The universal thrill  
King of all perfumes  
The cup of happiness  
The soothing draught  
Ambrosia of the Gods  
The intellectual drink  
The aromatic draught  
The salutary beverage  
The good-fellow drink  
The drink of democracy  
The drink ever glorious  
Wakeful and civil drink  
The beverage of sobriety  
A psychological necessity  
The fighting man's drink  
Loved and favored drink  
The symbol of hospitality  
This rare Arabian cordial  
Inspirer of men of letters  
The revolutionary beverage  
Triumphant stream of sable  
Grave and wholesome liquor  
The drink of the intellectuals  
A restorative of sparkling wit  
Its color is the seal of its purity  
The sober and wholesome drink  
Lovelier than a thousand kisses  
This honest and cheering beverage  
A wine which no sorrow can resist  
The symbol of human brotherhood  
At once a pleasure and a medicine  
The beverage of the friends of God  
The fire which consumes our griefs  
Gentle panacea of domestic troubles  
The autocrat of the breakfast table  
The beverage of the children of God  
King of the American breakfast table  
Soothes you softly out of dull sobriety  
The cup that cheers but not inebriates\*  
Coffee, which makes the politician wise  
Its aroma is the pleasantest in all nature  
The sovereign drink of pleasure and health\*  
The indispensable beverage of strong nations  
The stream in which we wash away our sorrows  
The enchanting perfume that a zephyr has brought  
Favored liquid which fills all my soul with delight  
The delicious libation we pour on the altar of  
friendship  
This invigorating drink which drives sad care  
from the heart

\* First written about tea; improperly claimed to have been written of coffee.

# INDEX

The Items in This Index Refer—Unless Otherwise Specified—to the General Subject of Coffee, and More Particularly to *Coffea arabica*; Other Varieties Are Distinguished by Their Trade or Scientific Names. Thus "Adulteration" Refers to the Adulteration of Coffee; and "Adulterants," to the Substances Used for That Purpose. Italicized Words Are Either Scientific Names, or Titles of Publications. Geographical Names Are Distributed under Various Topics, Such as "Acreage," "Coffee House," "Consumption," "Cultivation," "Exports," "Imports," "Production," and the Like.

Explanation of Marks: *c* signifies coffee; *chk*, coffee-house keeper; *ill.*, illustration; and *q*, quoted.

	PAGE		PAGE
<b>A</b>		<b>Acreage (Cont'd)</b>	
A. B. C. shop <i>ill.</i> .....	556	—Ceylon .....	512
Abbas, wife of .....	17	—Cuban .....	511
Abbey, Roswell .....	584	—Ecuador .....	174
Abbey, Freeman & Co. ....	417	—Espirito Santo .....	152
Adb-al-Kadir .....	469, 661, 662	—Federated Malay States .....	514
Abd-al-Kadir ms ..8, 10, 27, 469;		—Guatemala .....	177
<i>ill.</i> 660; 661		—Guiana, Dutch .....	506
Abele, Chris .....	598, 611, 612	—Hawaii .....	180, 514
<i>Abeokuta</i> <i>c.</i> .....	279	—India .....	194, 512
<i>Abeokuta</i> <i>x liberica</i> .....	283	—Jamaica .....	182, 509
Aborn, Edward .....	436, 477,	—Java .....	513
618, 621, 631, 646, 647		—Kenya .....	182, 515
Aborn, W. H. .....	418	—Malaya .....	187, 514
Aborn & Cushman .....	425	—Minas Geraes .....	152
About, Edmond F. V., <i>q.</i> .....	567	—Netherlands Indies ..188,189,	513
Abyssinian <i>c.</i> .....	129, 169, 207	—Nyasaland .....	190, 517
—U. S. regulations .....	369	—Paraná .....	152
Abyssinian longberry .....	169	—Pernambuco .....	152
<i>Account of his Journeys, An q.</i> ..	18	—Philippines .....	514
Ach (chemist) .....	312	—Puerto Rico .....	193
Ach, F. J. ....405, 406, 408,		—Rio de Janeiro .....	152
445, 490		—Salvador .....	194, 507
Acid coffees .....	305	—São Paulo .....	152
Acidity .....	294	—Straits Settlements .....	514
—Percentage in <i>c.</i> .....	651	—Sumatra .....	513
Acids .....	294	—Tanganyika .....	515
Acker, Finley .....	613, 617	—Tobago .....	195
Acker, Merrill & Condit Co..414,		—Trinidad .....	195
427, 434		—Uganda .....	196, 515
Ackland, James .....	114	—Venezuela .....	197
Acreage		Adams .....	679
—Abyssinia .....	170	Adams, Abigail, <i>q.</i> .....	399
—Argentina .....	506	Adams, Isaac .....	585
—Australia .....	515	Adams, John .....	106, 109
—Bahia .....	152	Adams, Pygan .....	726, 729
—Brazil .....	151, 503	Addison, Joseph ..71, 75, 76, 80,	
		676, 678; <i>q.</i> 679	
		Adjudication (N. Y. Exch.)....	365
		Adulterant Act, British .....	258
		Adulterants	
		—Date stones .....	291
		Adulteration	
		—U. S. law affecting .....	258
		Advertisements	
		—Against .....	473
		—Arbuckle's .....	473
		—Coffee house	
		—Boston .....	108
		—New York .....	115, 116
		—First .....	50, 469
		—First newspaper .....	52, 470
		—American .....	400, 471, 472
		—Of coffee only <i>ill.</i> .....	400
		—First printed, <i>q.</i> .....	469
		—London	
		—Early .....	470, 471
		Advertising	
		—History of .....	468–497
		—Billboard .....	475, 481
		—Booklets .....	471, 487, 497
		—Brands <i>ill.</i> .....	468
		—Broadsides, <i>q.</i> .....	470, 471
		—Car Cards .....	481; <i>ill.</i> 496
		—Charts .....	494
		—Constructive .....	496, 497
		—Electric signs .....	<i>ill.</i> 479; 481
		—Expenditures, roasters' .....	494
		—Evolution of .....	472
		—First co-operative .....	477
		—Germany <i>ill.</i> .....	493
		—Government propaganda .....	485
		—Handbills .....	471; <i>ill.</i> 472
		—First colored .....	473
		—Rosées, <i>q.</i> .....	470
		—Hungary <i>ill.</i> .....	493



# INDEX

791

	PAGE		PAGE
Advertising ( <i>cont'd</i> )		American Coffee Corp.....	386, 467, 622
—Injudicious .....	473, 477, 496	<i>American Grocer</i> .....	454
—Joint coffee trade ..	408, 474, 475, 477	<i>American Hist'l Register, q</i> .....	122
—Motion pictures..	481, 487, 491, 493	American Joint Coffee Trade	
—Newspaper and periodical..	472, 475, 476; <i>ill.</i> 486; 484	Publicity Com. ....	408
—Outdoor <i>ill.</i> .....	478, 481	<i>Am. Jour. Med. Science, q</i> .....	319
—Package-coffee .....	<i>ill.</i> 468; 477	American Mills .....	437
—Posters .....	475; <i>ill.</i> 486	American Stores Co. advertising	
—Radio .....	482, 493, 497	<i>ill.</i> .....	486
—Retail .....	484	Ames, Allan P. ....	490
—Store cards <i>ill.</i> .....	490, 497	Amman & Co., C. ....	412
—Sweden <i>ill.</i> .....	486	Amsinck, Gustave .....	416
—Trade journalists as experts...	469	Amsinck & Co., G. ....	416, 462
—United States		Amurath III .....	16
—  Expenditures .....	479	Amurath IV .....	16, 35
—  Wholesale .....	380	Anamalai c. ....	128, 206
<i>Advice against the plague, q</i> ....	54	<i>Anatomy of Melancholy, The,</i>	
Advisory Board ( <i>see</i> Gov't control)		<i>q</i> .....	35, 663
<i>Afinis, c.</i> .....	283	Ancilloto, Marco .....	23
<i>Aigentliche Beschreibung der</i>		"—" and <i>Other Poets, q</i> .....	672
<i>Raisis, etc., q</i> .....	8	Anderson .....	294, 295
Akers, Frederick .....	434, 435	Anderson, Adam, <i>q</i> .....	68, 69, 70
Alameda (brand) .....	479	Anderson, Aplin .....	438
Albert, King of Belgium .....	555	Anderson, Mrs., <i>chk.</i> .....	82
Alcoholism, effect on .....	319	Andreas, A. T., <i>q</i> .....	102
Aldhabani ( <i>see</i> Gemaleddin)		Andresen-Ryan Coffee Co. ....	439
<i>Ale wives' complaint against c.</i>		Anecdotes .....	684-703
<i>houses</i> .....	68	—Addison, Joseph ( <i>see</i> under	
Alexander-Balart Co. ....	441	Addison)	
Alhadrami, Muhammed .....	12	—Bismarck .....	685
<i>Al-Haiwi (The Continent)</i> .....	7	—Bonaparte, Napoleon .....	686
Alimentary tract, Effect of <i>c.</i> in.	315	—de Seigné, Mme.....	684
Alison, Archibald .....	98	—Fontenelle .....	685
<i>All About Tea, q</i> .....	317	—Grevy, Jules .....	685
Allen, Ida C. Bailey, <i>q</i> .....	658	—Johnson, Samuel .....	686-689
Allen, James Lane, <i>q</i> .....	684	—Saint-Foix .....	686
Allen & Lewis .....	443	—Savage, Richard .....	690
Allied Grocers, Inc. ....	466	—Scott, Hugh L. ....	686
Allison weighing and packing		—Steele, Sir Richard .....	690
<i>machine</i> .....	257; <i>ill.</i> 258	—Swift, Jonathan .....	690
Allom, Thomas .....	547	—Talleyrand, Prince .....	685
Alpini, Prospero ..8, 21, 22, 39,	266, 469	—Voltaire .....	684, 685
<i>Alt und neu Wien, q</i> .....	45, 47	Andrews, William Ward ...	585, 631
Altenberg, Peter, <i>q</i> .....	669	Andrews & Co., C. E. ....	441
Altitudes		Andry, Dr. ....	624
—Best .....	134	Angola c. ....	208
—Brazil .....	151	<i>Angustifolia c.</i> .....	278
—Colombia .....	162	Ankola c. ....	209
—Honduras .....	181	—In blends .....	252
—Jamaica .....	182	Anne, Queen .....	55, 76
—Kenya .....	182	<i>Année Littéraire, q</i> .....	2, 3, 4
—Mexico .....	135, 185	Anthony, Frank M. ....	416
—Nicaragua .....	189	Antiguas c. ....	202
—Puerto Rico .....	193	<i>Antiquarian Rambles in the</i>	
—Salvador .....	194	<i>Streets of London, q</i> .....	689
Aluminum Cooking Utensil Co..	622	Antiseptic, <i>c.</i> as an.....	316, 319
Aluminum Products aluminum		Antrim & Sons, C. W.....	446
<i>drip c.-pot</i> .....	633	Apel, Paul E. ....	442
<i>Amarella c.</i> .....	278	Apothecaries' shops, sold in...	469
Amber (essence of) in <i>c.</i> .....	625	Apparatus, Evolution of ...	575-622
Ambergris in <i>c.</i> .....	642	Appearance .....	210
<i>Ambrosia Arabica, q</i> .....	626, 677	Appenzeller, John C. ....	439
American-Brazilian Assn. ..	408, 467	Applegate, John .....	427
American Can Co.....	259, 378, 404, 482	<i>Arabia, Description of, q</i> .....	18
<i>Am. Chem. Journal, q</i> .....	293	<i>Arabian Chrestomathy, q</i> .....	13
American Coffee Co.....	446, 450	Arabian c. ( <i>see</i> Mocha)	
		Arabian Nights, The .....	19, 27
		<i>Arabica c.</i> .....	198, 200, 269, 270, 279
		—Botanical description .....	271-275
		<i>Arabica c. (cont'd)</i>	
		—India .....	194
		—Netherlands Indies .....	188, 208
		—Trinidad & Tobago .....	195
		—Uganda .....	196-207
		Arbitration (N. Y. Exch.)....	362
		—Committee .....	365
		<i>Arbor yemensis fructum coffe</i>	
		<i>ferens, etc., The</i> .....	38, 663
		Arbuckle advertising ..	473, 477, 478
		Arbuckle, Charles .....	451, 452
		Arbuckle, John (and Mrs.)	403, 431, 447, 451-453, 477, 616
		Arbuckle Brothers ..	403, 416, 434, 435, 437, 451, 459, 460
		Arbuckle Farm .....	453
		Arbuckles & Co. ....	443, 451, 452
		Arbuckle's Breakfast (brand)...	453
		Arbuckle's Vacuum (brand)...	453
		Arbuthnot, Dr. ....	77, 80
		Arcade Manufacturing Co. ....	612
		<i>Archives of Psychology, q</i> .....	311
		Arcularius, James L. ....	435
		Arding, Dr. Charles .....	114
		Arduino, Pier Teresio .....	618
		Ariosa (brand) ..	403, 452, 477, 478
		Arkell, Bartlett .....	466
		Arkell, W. J. ....	466
		Arliss, George .....	126, 676
		Armenias c. ....	127, 203
		Armstrong & Barnewall .....	411
		Arndt, Chris .....	416, 417
		Arner, O. Q. ....	493
		Arnold, B. G. ..	403, 412, 414, 426, 447, 455
		Arnold, Francis B. ..	403, 412, 413, 414, 426, 447
		Arnold & Aborn .....	434
		Arnold & Co., B. G. ..	403, 414, 416, 426, 456
		Arnold, Cheney & Co. ....	417
		Arnold, Dorr & Co. ...	414, 425, 448
		Arnold, Hines & Co. ....	417
		Arnold, Mackey & Co. ....	413, 414
		Arnold, Sturgess & Co. ....	414
		<i>Arnoldiana c.</i> .....	279
		Aroma	
		—Advertising value, retail ...	392
		—Best grinds to preserve .....	652
		—Cause of .....	295, 307
		—Chaff rich in .....	641
		—Cup-testing for .....	210
		—Preservation of .....	657
		Aroma Coffee & Spice Co.....	438
		Aromatic principles of <i>c.</i> .....	298
		Aron & Co., J. ....	425
		Art Collections	
		—Bostonian Society .....	731
		—Ireland, Sam .....	711
		—London	
		—  Beaufoy .....	58, 59, 60
		—  British Museum .....	727
		—  Guildhall Museum .....	725
		—  Victoria and Albert .....	719
		—Maine Historical Society ...	732
		—New York	
		—  Clearwater .....	726, 727, 729
		—  Halsey .....	726, 729
		—  Metropolitan Museum ..	718, 726, 727
		—Paris: Cluny Museum .....	718

	PAGE		PAGE		PAGE
Art Collections ( <i>cont'd</i> )		Balzac, Honoré de, <i>q.</i> .....	98, 676, 677	Beede, N. B. ....	444
—Salem, Mass.: Essex Inst. ....	732	<i>Balzac, q.</i> .....	676	Beekmans, The . . . . .	411
—Washington		Balzac Bros. ....	425	Beer, Coffee .....	644
—Peter (U. S. Nat'l Mus.)		Ban .....	22, 31	Beeson, Emmet G., <i>q.</i> .....	561
	718, 731	Bananas and coffee .....	624	Bégon .....	2
<i>Arthur's, q.</i> .....	682	Banco do Brasil.....	327	Behrens & Co., A.....	417
Aruwimensis <i>c.</i> .....	281	Banco Mineiro de Café.....	159	Belcher, Jonathan .....	108
Aschner, Dr. Bernhardt, <i>q.</i> .....	318	Bangs, John Kendrick, <i>q.</i> .....	684	Belgian Congo <i>c.</i> .....	208
Ash (seed) .....	292	Bank of New York.....	116	Belighi .....	667
Ashland, James .....	413	Banks, H. W. ....	415	Bell & Co., J. H. ....	437
Associação Commercial de Santos	333	Banks & Co., H. W.....	415	Bell, Conrad & Webster.....	437
Associated Coffee Industries of		Baptized by Clement VIII.....	22	"Bellaire" enamel percolator.....	633
America .....	406, 409, 650	Barbados <i>c.</i> .....	206	Belli .....	669
—Research .....	650	Barbaro, Angelo Maria.....	24	Belli, Onorio .....	27
Associations		Barber shops, <i>c.</i> in.....	540, 541	Belna (brand) .....	466
—Brazil .....	158	Barclay, Florence L., <i>q.</i> .....	683	Bencini, Antoni .....	584
Atha, F. P. ....	391, 439	Barclay & Hasson.....	443	Benedicenti, <i>q.</i> .....	311
<i>Athenae Oxiensis à Wood, q.</i> ....	37	Barnardini, <i>q.</i> .....	311	Benedict & Gaffney.....	429, 433, 435
Athletes, <i>c.</i> for .....	320	Barnes, Dr., <i>q.</i> .....	308	Benedict & Thomas .....	429, 435
Atlas Mills .....	434	Barnicle, Michael .....	417	<i>Beneficio</i> .....	143
Atwood & Co. ....	440	Baro, José .....	618	<i>Bengalensis c.</i> .....	283
Atwood & Holstad .....	440	Barotti, L. ....	668	Bengiazlah .....	8, 13, 660
Aubrey, John .....	36, 49, 55, 56	Barr, Thomas T.....	417	Bengis .....	294, 295
Auctions		Barr & Co., T. M.....	457	Bennett, James .....	417
—Amsterdam .....	40, 358	Barr & Co., T. T.....	403, 413, 417	Bennett, William .....	415, 417
—First (1711) .....	40	Barr, Lally & Co.....	417	Bennett & Becker.....	417, 435
—London .....	357	Barrington Hall (brand).....	440, 466, 478	Bennett & Son, W. H.....	417, 425
—Netherlands Indies .....	344	Bars, coffee .....	491	Bennett, Sloane & Co.....	435
<i>Augagneuri c.</i> .....	284	—Paris, <i>ill.</i> .....	565	Bentley, Benton & Co.....	417, 434
Austin, Nichols & Co. ....	427, 435	Barth, Chas. D. ....	622	Berchoux .....	668
Autocrat (brand) .....	478	Barth, G. W. ....	601	Berdan Co. ....	442
Avicenna (Ibn Sina), <i>q.</i> ..7, 8, 14,		Barthez .....	686	Berg, Thomson & Davis.....	437
	469, 660	Bartlett (artist) .....	551	Berhard, Charles .....	441
à Wood, Anthony, <i>q.</i> .....	37	Bartlett, B. L. ....	415	Berkeley, Bishop .....	669
Ayduis .....	10	Bartow, H. ....	433	Berkson, Adolph .....	425
Ayer & Son, N. W. ....	490, 493	Bastian-Blessing Co. ....	622	Bermann, M., <i>q.</i> .....	45
Aymar & Co. ....	412	Bates, Harry C.....	622	Bernard, Claude M. V.....	585
		Bauer, Dr. A. W., <i>q.</i> .....	318	Bernheimer, <i>q.</i> .....	299
		Bauer Bros. Co.....	615, 621, 622	Bernier .....	27, 576, 711
		Bay, Gottfried .....	611	Berry, Benjamin .....	443
		Bayne, Daniel K. ....	414	Berry, Eugene G.....	622
		Bayne, L. P. ....	414	Berry & Sons, N.....	436
		Bayne, Jr., William.....	407, 408, 414, 418, 490	Berthier .....	98
		Bayne, Sr., William.....	414, 415	Bertrand, Prof. ....	284
		Beach & Co., J. D.....	444, 445	Berytus, Bishop of, <i>q.</i> .....	38
		Beaham-Moffatt Mfg. Co.....	444	Besant, Sir Walter, <i>q.</i> .....	71, 74
		Bean		Beverage,	
		—Cross-section <i>ill.</i> .....	279, 287, 288	—Buds as basis .....	624
		—Microscopic structure .....	286, 289, 291, 294	—Definition .....	655
		—Roasted <i>ill.</i> .....	651	—Discovery .....	655
		Bean broth, Javanese.....	7	—Evolution of .....	623
		Beard, Eli .....	428, 431	—First use as.....	623
		Beard, Samuel S.....	428, 431	—Fruit and bananas.....	624
		Beard & Co., Samuel S.....	417, 431	—History, early .....	7-19
		Beard & Cummings.....	417, 429, 431, 442	—Hull and pulp as basis.....	275, 537, 624
		Beard & Howell.....	431	—Husks as basis.....	624
		Beard, Sons & Co., S.M.....	435	—Origin	
		Beards & Cottrell.....	417, 431	—First reliable date.....	12
		Beaufoy collection .....	58, 59, 60	—Legendary .....	6
		Beaumarchais .....	91	<i>Beverages Past and Present, q.</i> ...	686
		Beauvarlet, J. ....	704, 705	<i>Bible</i> .....	8, 9
		Beccaria, Cesare .....	26, 677	Bichivilli, <i>q.</i> .....	18, 662
		Becker, Joseph .....	417	Bickford, Clarence E.....	414, 422, 424
		Beckley, S. W. ....	442	Bickford & Co., C. E.....	424, 425
		"Beccolator" enamel drip c-pot... 633		Biddulph, William, <i>q.</i> .....	33, 36
		Beecher, C. McCulloch.....	426	Biedermann Bros. ....	438
		Beech-Nut Packing Co.....	446, 466	Biehl, J. F. ....	454
		—Advertising display, etc. <i>ill.</i> .....	487, 496	Bigelow, Francis Hill.....	726
				Biggin, coffee ( <i>see</i> Infusion de- vices)	

## B

Baba Budan .....	194
Babillard, <i>q.</i> .....	679
Bach, Johann Sebastian...42, 712-715	
Bache, Theophylact .....	411
Backer, Leslie .....	609
Bacon, Francis, <i>q.</i> .....	35, 663
Bacon, Williamson .....	416
Bacon & Co., Williamson.....	416
Bacon, Stickney & Co.....	444, 446
Bag maker and packer <i>ill.</i> .....	254
Bagdad coffee pot .....	718
Bags, paper ( <i>see</i> Containers)	
Bags, shipping	
—Brazil .....	327
—Colombia .....	338, 339
Bahias <i>c.</i> .....	198, 200
Baiz & Wakeman.....	413
Baker, John Gulick.....	601
Baker, Lewis S. ....	620
Baker, Roger .....	113
Baker, T. K. ....	616
Baker, William E. ....	617
Baker & Co. ....	617
Baker & Sons, Joseph.....	604
Baker Importing Co.....	440, 466
Balart, B. D., <i>q.</i> .....	252, 303
Baldwin, Captain .....	465
Baldy & Co., J. B.....	442
Balfour, Guthrie & Co.....	425
Baltagi .....	19

# INDEX

793

PAGE	PAGE
Bill & Co., Alexander H. . . . . 436	Brain, Effect on. . . . . 307
Bill Co., James G. . . . . 446	Braley, Berton, <i>q.</i> . . . . 673
"Billy can" . . . . . 575	Bramhall Deane Co. . . . . 594
Bingham, Robert O. . . . . 621	Branco, João Alberto Castello . . . 149
Bins . . . . . 249, <i>ill.</i> 254	Brand, Carl W. . . . . 405, 407, 443, 490
—"True-flow" . . . . . 249	Brandenburg, Elector of. . . . . 41
<i>Biographie Universelle, q.</i> . . . . 4	Brandenstein, Edward . . . . . 441
Bishop, J. Leander, <i>q.</i> . . . . 101, 111	Brandenstein, M. J. . . . . 432, 441
Bishop, Nathaniel . . . . . 106	Brandenstein, Manfred . . . . . 441
Bisland & Brown . . . . . 433	Brandenstein & Co., M. J. . . . . 441
Bismarck, Prince von. . . . . 685	Brasher, Abraham . . . . . 729
Black coffee . . . . . 557	Brasher, Ephraim . . . . . 728, 729
"Black jack" . . . . . 369	Brasiliensk Kaffe Kompagni. . . . 492
Blackall, Alfred H. . . . . 437	Brass, Italice . . . . . 675
Blackhawk Coffee & Spice Co. . . . 446	Braun Co. . . . . 615
Blair, Henry . . . . . 431, 454	Brazil Coffee Co. . . . . 414
Blair, Henry B. . . . . 429	Brazil coffee delegation. . . . . 406, 408; <i>ill.</i> 409, 573
Blair, Sidney O. . . . . 437	Brazilian-American Coffee Prom- tion Committee. . . . . 477, 481, 493
Blake, Charles F. . . . . 418	—Educational campaign . . . . . 493
Blake, John H. . . . . 426	—Members . . . . . 493
Blake, Walter F. . . . . 417, 463	—Scientific research . . . . . 493
Blake & Bullard . . . . . 418	Brazils <i>c.</i> . . . . 127, 129, 198
Blakeman, C. R. . . . . 415	Brewing . . . . . 623-658
Blanc, Louis . . . . . 99	—Art of
Blanchard & Bro. . . . . 436	—Calkin's patent . . . . . 619, 633
Blanco, Guzman . . . . . 457	—Muller's patent . . . . . 620, 633
Blaney, Henry R., <i>q.</i> . . . . 106	—Chemical analysis, first. . . . . 646
Blanke, C. F. . . . . 439, 618, 621	—Chemistry of . . . . . 651
Blanke, R. H. . . . . 439	—Clarifying . . . . . 652
Blanke Coffee Co. . . . . 439	—Comparison of methods. . . . . 652
Blanke Tea & Coffee Co., C. F., 438, 466	—Correct methods
Blanke's Health Coffee. . . . . 466	—Advertising . . . . . 482
Blecker & Co., Edw. . . . . 425	—Ceole . . . . . 571
Blending . . . . . 250	—Filtration <i>vs.</i> percolation. . . . . 581
—Retail . . . . . 388	—N.C.R.A. recommendations. . . . 477, 646
Blends . . . . . 198, 250, 251, 656	—Recipe 1662 . . . . . 625
—French preferences . . . . . 562	—Research, Univ. of Kansas. . . . 646
—Package coffees . . . . . 250	—Scientific
Blickman, Saul . . . . . 620	—Prescott . . . . . 653-655
Bliss, Dallett & Co. . . . . 417	—Trigg . . . . . 651-653
Blodgett, Albro . . . . . 442	—Temperature effects on. . . . . 646, 648, 654
Blodgett, Henry P. . . . . 442	—Tests . . . . . 648
Blodgett-Bleckley Co. . . . . 442	—Water, effect on. . . . . 655
Blook & Varwig. . . . . 439	—von Liebig's method. . . . . 564, 567, 570
Bloom, Daniel . . . . . 114	Brewing devices . . . . . 105
Blossoms <i>ill.</i> . . . . 178, 190	—Acker . . . . . 613
—Bridal flowers in Antilles. . . . . 685	—Ambassador urn <i>ill.</i> . . . . 636
Blount, Sir Henry. . . . . 9; <i>q.</i> 35: 51	—Amcoin urn <i>ill.</i> . . . . 636
Blue Mountain <i>c.</i> . . . . 182, 205	—American, early <i>ill.</i> . . . . 630
Blunt, Anne . . . . . 52	—Early <i>ill.</i> . . . . 630
Boardman, George . . . . . 444	—Present-day <i>ill.</i> . . . . 632, 633
Boardman, Howard F. . . . . 444	—Andrews' reversed Fr. drip. . . . 585
Boardman, Lot. . . . . 406, 408, 445	—Asiatic <i>ill.</i> . . . . 640
Boardman, Thomas J. . . . . 430, 444	—Bastian-Blessing's urn <i>ill.</i> . . . . 636
Boardman, William . . . . . 430, 444	—Best materials. . . . . 649, 653, 655
Boardman, William F. J. . . . . 444	—Blickman's . . . . . 620; <i>ill.</i> 636
Boardman & Sons Co., Wm. . . . . 444	—Care of . . . . . 653
Boathouse Coffee & Tea Co. . . . . 439	—Casseneuve's <i>ill.</i> . . . . 583
Boconos <i>c.</i> . . . . 205	—Cauchois's porcelain-lined urn. 613
Bodleian library . . . . . 49	—Cauchois's centrifugal pump. . . . 618
Boengie . . . . . 210	—Chapman's tea or coffee pot. . . . 617
Bogotas <i>c.</i> . . . . 127, 203	—Cloth bag <i>ill.</i> . . . . 630
—Microscopical structure <i>ill.</i> . . . . 286	—Combined making and serving pot . . . . . 576
Bohler & Weikel. . . . . 436	—DeLuxe urn <i>ill.</i> . . . . 636
Boilers	—De Vry restaurant drip <i>ill.</i> . . . . 658
—English <i>ill.</i> . . . . 630	—Drip-o-Lator <i>ill.</i> . . . . 636
—First . . . . . 575	
Boiling . . . . . 645, 649	
—Clarification . . . . . 652	
—First use . . . . . 624	
Boiling ( <i>cont'd</i> )	
—N.C.R.A. recommendations . . . . 646	
—Objection to . . . . . 626, 644	
—Prescott discusses . . . . . 654	
—Trigg discusses . . . . . 652	
Boinest, Walter B. . . . . 434	
Bokar (brand) . . . . . 379	
Bolivian <i>c.</i> . . . . 205	
Bolsa Official do Café, Santas, 331, 332	
Bon . . . . . 22, 31	
"Bon Marche" enamel drip c-pot. 633	
Bonaparte, Napoleon. . . . . 91, 93, 419, 686, 711, 713	
Bonn . . . . . 267	
Bonnett, Schenck & Earle. . . . . 435	
Bonniere <i>c.</i>	
—Caffeine content . . . . . 284	
Bonsor & Co., C. F. . . . . 437	
Bontius, Jac., <i>q.</i> . . . . 266	
Book, Nicholas . . . . . 577	
Booms . . . . . 455-458	
—Bubonic plague . . . . . 457	
—Southern . . . . . 458	
—United States. . . . . 404, 405, 408, 456	
Booth, A. F. . . . . 444	
Booth, Otis W. . . . . 416	
Booth & Lindsley. . . . . 403, 413, 416	
Borden's Farm Products Co. . . . . 466	
Borino & Bro. . . . . 420	
Boscul (brand) . . . . . 478	
Bossi, Verneti & Bartolini. . . . . 618	
Boston coffee party . . . . . 399	
<i>Boston News Letter.</i> . . . . 471	
Boston tea party. . . . . 102, 106, 571	
Boswell, James . . . . . 77, 84, 686, 687	
Botanical description. . . . . 8, 22, 37, 269	
—Classification . . . . . 269, 270	
—Family class . . . . . 270	
—Microscopic . . . . . 286-291	
—Species, number of. . . . . 270	
Botanical gardens ( <i>see Gardens</i> )	
Botany of coffee. . . . . 268-285	
<i>Bottega di Caffè, La.</i> . . . . 24	
Bouche, Charles J. . . . . 440	
Boucher, Francois . . . . . 706, 708	
Boulton, Bliss & Dallett. . . . . 417	
Bour, J. M. . . . . 442	
Bour Co. . . . . 442	
Bourbon <i>c.</i> . . . . 198, 199, 208	
—Grand . . . . . 207	
—Le Roy . . . . . 207	
—rond . . . . . 207	
—Santos. . . . . 199; <i>ill.</i> 200; 251, 252	
Bourne, H. R. Fox, <i>q.</i> . . . . 51	
Bovee & Co., Wm. H. . . . . 421, 441	
Bowers, B. O. . . . . 416	
Bowman <i>chk</i> . . . . . 49, 51	
Bowman, John . . . . . 598	
Bown & Bro., W. T. . . . . 443	
Bown & Co., W. T. . . . . 425	
Bowne, Wm. . . . . 411	
Boyd & Co., G. . . . . 437	
Braas, Joseph . . . . . 443	
Bradford, Cornelius . . . . . 115, 116	
Bradford, Phebe C. . . . . 732	
Bradford, William . . . . . 122, 123, 124	
Bradley, Prof. R. . . . . 38	
Bradley, Richard, <i>q.</i> . . . . 54, 525	
Brady, Cyrus Townsend. . . . . 683	
Brady, Dr. William, <i>q.</i> . . . . 315, 316	

	PAGE		PAGE		PAGE
Brewing Devices ( <i>cont'd</i> )		Brewing Methods ( <i>cont'd</i> )		Bubonic-plague boom	457
—Duparquet's urn	601	—New Orleans	571, 642	Bucaramangas c.	127, 203
—Early <i>ill.</i>	577	—New York		Buc'hoz, Pierre Joseph, <i>q.</i>	641
—Earthenware, painted	537	—Hotel Ambassador	572	Buck, John H., <i>q.</i>	728
—European		—Waldorf-Astoria	572	Buckeye (brand)	472
—Early <i>ill.</i>	630	—New Zealand	574	Buckeye Aluminum Co.	622
—Present-day <i>ill.</i>	640	—Palestine	551	"Buckeye" one-cup aluminum drip	
—"Express"	621	—Panama	574	<i>c.</i> -pot	633
—First boiler	575	—Philippines	574	Budan, Baba	1
—First French patent	581, 628	—Portugal	570	Buds, beverage from	624
—First glass	631	—Roumania	569	Buell & Co., Geo. C.	445
—First U. S. patent	584, 629	—Russia	569	Buffon	93
—Fountain <i>ill.</i>	630, 638	—Scandinavia	569	<i>Bukobensis c.</i>	283
—French, early <i>ill.</i>	582, 584	—Serbia	569	Bulfinch, Charles	109
—Glass <i>ill.</i>	634	—Spain	569, 570	<i>Bullata c.</i>	278
—Glass vacuum	585	—Switzerland	569	Bun	8, 265, 267
—Household <i>ill.</i>	632, 633	—Turkey	27, 548, 551	Bun safi (cleaned beans)	172
—Immersion type	622	—Syria	551	Buna	37
—Italian rapid <i>ill.</i>	492, 618	—United States	570-573	Bunbund	267
—Jackson's urn	637	—Jabez Burns' method	645	Bunca	8, 21
—La Pavoni <i>ill.</i>	635	—Early	641, 642	Bunchum	7, 8, 21
—Le Brun's Cafetière <i>ill.</i>	630, 643	—Thurber's recipe	645	Bunchy	35
—Manning's combined	598	Bridgeport Brass Co.	622	Bunge, Edouard	460, 461
—Martelley's patent	584	<i>Brief and merry history of Eng-</i>		Bunn	8, 14, 31, 265
—Monouse's urn	601	<i>land, q.</i>	73	Bunnu	8, 21, 35
—Napier-List machine	601	<i>Brief description of the excellent</i>		Bureau of Business Research	371
—Rabaut's reversed drip	583	<i>virtues, etc.</i>	66, 67	Bureau of Coffee Information	482
—Raparlier's pocket	598	Briggs, James H.	412	—Publicity material, <i>ill.</i>	483
—Rathbone's	620	Briggs & Meehan	412	Burke, Edmund	77
—Research	646	Bright, Louis J.	425	Burn, J. H., <i>q.</i>	59
—Savage's tea or coffee pot	617	Brillat-Savarin	627, 677	Burning coffee (Brazil)	159
—Sené's, "without boiling"	582	British E. African c.	207	Burns, A. Lincoln	247, 454
—Sloss urn	621	British East India Co.	70, 77, 102	Burns, George, <i>chk.</i>	117
—Still's steam coffee-maker	616, 637	British Museum ( <i>see also</i> Art col-		Burns, Henry	444
—Stott's urn	637	<i>lections)</i>	33, 34, 36, 50,	Burns, Jabez, <i>q.</i>	238, 403, 427,
—Urns	635; <i>ill.</i> 636; 637		51, 58, 60, 61	431, 447, 452-454, 595-597	
—Vacuum type	620, 622, 631, 632	Broadbent, Humphrey <i>q.</i>	525,	—Machinery patents	595-598
—Whistling tea or c. pot	621		578, 626, 627	Burns, Kenneth	454
—White's urn	618	<i>Broadside Against Coffee, A q. ill.</i>		Burns, Robert	454, 616, 619
Brewing methods	634		65, 66	Burns, William G.	454, 608, 620
—Arabia	540, 541, 546, 551	Broadsides and pamphlets	54,	Burns & Brown	429
—Australia	574		61-68, 75	Burns & Sons, Inc., Jabez	242,
—Austria	554	Brock, J.	439	243, 454, 607, 608	
—Belgium	555	Brokerage charges		Burstone mills	598
—Brazil	573	—Ethiopia	342	Burton, Robert	9, 35, 663, 676
—Bulgaria	560	—New York	367	Busby, Dr. H. H., <i>q.</i>	317
—Canada	570	Brokers		Bush Terminal	349; <i>ill.</i> 351
—Ceylon	553	—Arabia	343	Butler, Crawford & Co.	444
—China	553	—Ethiopia	341	Butler, Earhart & Co.	444
—Continental	640	—London	357	Butron, <i>q.</i>	293
—Cuba	574	—New York	367	Buying ( <i>see</i> trading)	
—Denmark	561	—San Francisco	354	Buying and selling green coffee,	
—England	555	Bronson, Jr., A. E.	616	323-370	
—Early	628, 637-640	Bronson, Zenos	585	—Brazil	323-335
—Europe	554	Bronson-Walton Co.	616	—Rio de Janeiro	325
—19th century	637	Brooks, Harlow <i>q.</i>	319	—Santos	325-335
—Finland	561	Brown, Arthur W.	417	—Colombia	335-340
—France	561, 564, 640	Brown, James	433	—Europe	355-357
—Buc'hoz's recipe	641	Brown, Tom <i>q.</i>	71	—United States	347-355
—Germany	567	Brown & Jones	433		
—Greece	567	Brown & Scott	433, 435		
—India	553	Brown & Co., T. Barbour	425		
—Iran (Persia)	553; <i>ill.</i> 624	Brownell & Field Co.	446		
—Italy	568	Browning, Charles H.	122		
—1691	626	Bruce, James <i>q.</i>	623		
—Japan	553	Bruckman & Co., L.	431		
—Java	554	"Brulette" enamel drip <i>c.</i> -pot	633		
—Levant	625	Bruff, Sr., Thomas	580		
—Martinique	574	Brûteau, Cafe	102		
—Mexico	570	Bruning, William H.	620		
—Netherlands	568	Bruno, Bishop Joachim	5		

## C

Cabarets à caffè	29
—( <i>See also</i> Coffee houses)	
Cable-break panic	456
Cabrera, Roma & Co.	422
Cafamarine	284
Café	265, 267
—a la creme	565, 641
—a la minute	641

# INDEX

795

	PAGE		PAGE		PAGE
Café ( <i>cont'd</i> )		Cahue	23, 265, 266	Cauchois, Frederick A.	428, 434, 613, 617, 618
—a la Russe	569	Cahve	27	Cauphe	35
—amarello	199	Cahwa	41	Cavanaugh, Rearuck & Co.	438
—au lait	563, 571, 575, 626, 641	Caixa da Liquidacão	321	Cave	27, 266
—bonifieur	146	Cake ( <i>see</i> tablet)		Caveah	266
—branco	199	Caleb, Negus	1	Cavee	22
—commun	199	California Packing Corp.	441	Cavekane	27
—complet	565	Calkin, Benjamin H.	619	Cayenne <i>c.</i>	205
—con leche	573	Calvados	564	Cellulose in <i>c.</i>	293, 295
—de luxe	147	Cambron, C. G.	425	Centlivre, Susannah, <i>q.</i>	674
—de tierra caliente	197	<i>Campaigning with Grant, q.</i>	682	Central American coffee	
—de tierra fria	197	Campbell, Charles	417	—San Francisco's fight for trade	423, 424
—en parche	147	Campbell & Woods Co.	446	Central Americans <i>c.</i>	202
—en pergamino	190	Campen, Christopher, <i>q.</i>	8	Centro do Commercio do Café.	325
—gloria	565	Canby, Edward	430, 445	Century of Progress Exposition.	493
—mazagran	538, 564, 565	Canby, Frank L.	445	Cereal coffees	317
—melange	555	Canby, Ach & Canby	444, 445	Ceremony, coffee	625
—murtha	199	<i>Canephora e</i>		Certified Java and Mocha	453
—nature	565	—Botanical description	282	Ceylons <i>c.</i>	173, 206, 207
—Noir	565, 571	—Ceylon	173	Chaa	31
—pergamino	165	—Varieties	282	Chaff	
—sultan	540, 624	Canesa, Amadeo S.	235, 237	—Granulator	608, 622
—sultane	624	Cans ( <i>see</i> Containers)		—Rich in caffeine and aroma	641
<i>Café, literary, artistic, and com-</i>		Cantatas		Chain stores	385, 388
<i>mercial, The</i>	30	—Bach, <i>q. ill.</i>	712-715	—Costs and profits	387
<i>Café du roi, Le</i> (opera)	711	—Fuzelier, <i>q.</i>	711, 712	—Types	381, 386
Cafea	267	Cantino, Cesare	669	Chamberlain, George A., <i>q.</i>	683
<i>Caféier et le Cafe, Le ill., q. 2,</i>	10, 27, 266, 587	Caova	22, 37, 266	Chamberlain, Orville W.	620
Cafés ( <i>see</i> coffee houses)		Ca-phé	267	Chamberlaine, John, <i>q.</i>	471
Cafés chantants ( <i>see</i> Coffee houses)		Caphe	35, 265	Champmeslé	87
Cafezal	151	Capitazias	329	Champney, Elizabeth W., <i>q.</i>	683
Caffé	23, 265, 267	Captain Cook Coffee Co. estate,		Chaoua	31, 265, 266
<i>Caffè, Il, Belli</i>	669	Hawaii	178	Chaova	37
<i>Caffè, Il</i> (almanac)	677	Caracas <i>c.</i>	128, 204	Chapin, Harold	676
<i>Caffè, Il</i> (periodical)	26, 677	Caracollilo	192	Chapman, D. J.	436
<i>Caffè Pedrocchi, Il</i> (periodical)	678	Caramelizing	237, 239, 295	Chapman, J. W.	617
Caffeine	293, 295-297, 313	Carazo, Padre	173	<i>Character of a coffee house, The</i>	
—Contents in cup of <i>c.</i>	310	Carbohydrates	293	(broadside), <i>q.</i>	61-64
—Determination of	297, 298	Carbon dioxide	654	Characteristics	
—Harmless in moderation	307, 317	Cardamom in coffee	540, 642	—Complete reference table	212-232
—Hollingworth's experiments	308, 309, 648	Caret, <i>q.</i>	675	—Green and roasted	198-211
—In leaves	285	Carey	76	—Leading growths (chart)	129
—Loss in roasting	651	Cargoes		Charcoal, coffee classed as	16
—Medical opinions	314-320	—Damaged	349	Charles II	16, 55, 56, 67, 69, 78, 105
—non-cumulative action	311	—Record	344	—Proclamation against <i>c.</i> houses.	68
—non-habit forming	309, 310, 315	Carhart & Bro.	417	Charlet	711, 713
—Removal patent	620	Carjat	99	Chase, Caleb	430, 436
—Robusta	282	<i>Carmen Caffaeum, q.</i>	10, 663	Chase & Co., Geo. C.	434
—Solvents	298	Carne, John, <i>q.</i>	552	Chase & Sanborn	379, 434, 436, 472
—Stimulating effects	307, 316, 317	Carnegie, Andrew	451	—Advertisements, <i>ill.</i>	477, 481
—Tolerance	310	Carney, J. E.	438	"Chase" chromium drip <i>c.</i> -pot.	633
Caffeine-free coffee	258, 405, 621, 622	Carpenter, Samuel	122	Chase, Raymond & Ayer	436
—Artificial	258	Carr, Chase & Raymond	436	Chatfield-Taylor, H. C., <i>q.</i>	675
—Natural	283	Carret & Co., J. E.	425	Chatterton, Thomas	76, 80, 83
—Trees, <i>ill.</i>	279	Carson, James S.	409	Chattopádhyaýa Virendranath, <i>q.</i>	265, 266
Caffeol	293, 651-653	Carte, D'Oyly	560	Chaube	21, 37, 266
Caffeone	293	Carter, James W.	427, 589	Cheek, Joel O.	405, 408, 432, 445
Caffetan, <i>ill.</i>	549	Carter Bros. & Co.	443	Cheek-Neal Coffee Co.	445
Caffetannic acid	293, 653	Carter, Macy & Co.	416	Cheek, Norton & Neal	445
—Misnomer	648, 651	Carter, Mann & Co.	436	Cheetham, Jr., William H.	437
Caffinets	540; <i>ill.</i> 547	Cartons ( <i>see</i> Containers)		Chemical analysis	
Cage, R. H.	440	Casanas, Ben C.	405, 407, 441	—Bean	292-98
Cage & Drew	440	Case, Howard E.	431	—Beverage	305, 653
Cage, Drew & Co., Ltd.	441	Caseneuve	629	—Table	293
Çahoa	265, 266	Castel, <i>q.</i>	667	Chemistry of the coffee bean	292-305
Çahouah	11	Caswell, George W.	441	Cheney, Dr. Ralph H., <i>q.</i>	320
Cahoue	87	Caswell Co., George W.	441, 622		
Cahua	35, 265	<i>Catalogue of Traders' Tokens, q.</i>	59		
		Catch crops	139		



PAGE		PAGE	PAGE
	Chess in c. houses.....	93,95, 100	
	Cheyne, George, q.....	55	
	Chibouk .....	538, 547	
	Chicago World's Fair .....	488	
	Chicory		
	—Botanical description .....	258	
	—Introduced into U. S. ....	400	
	—Microscopic exam. ....	291	
	—Substitute for .....	258	
	—U. S. law regarding.....	258	
	Chicory in coffee		
	—Belgium .....	555	
	—Great Britain .....	556	
	—Paris .....	554	
	—Scandinavia .....	569	
	—Vienna .....	554	
	Chlorogenic acid .....	297, 622, 651	
	Choate, Joseph H. ....	572	
	Chocolate		
	—Discovery of .....	8	
	—Introduction into N. America.	102	
	—Prices. London .....	55	
	—Sold in London .....	53	
	—Sold in London c. houses....	37, 57	
	Chocolate houses (see Coffee houses)		
	Chops		
	—Brazil .....	327	
	—New York .....	347	
	<i>Chrestomathie Arabe</i> , q. 13, 267,	546	
	Chubuck & Saunders .....	444	
	Churchill & Co., Frederick A....	438	
	Cinnamon in coffee....	101, 625, 642	
	Cincinnati Spice Mills .....	439	
	Cipriani .....	80	
	Cirio Co. ....	237	
	<i>City, The</i> , q.....	81	
	City Coffee Works .....	426	
	Civil War .....	403, 420, 520, 528	
	Clarification .....	567, 622, 625, 627, 638, 652	
	Clark, Ammi .....	585	
	Clark, Charles A. ....	408, 442	
	Clark & Host Co. ....	442	
	Clarke Bros. & Co. ....	444	
	Classifying (see Grading)		
	Cleaning .....	147, 241; ill. 343	
	Cleaning machinery, ill. ....	158	
	—Burns, ill. ....	241	
	—“Catador” .....	147	
	—Gump “Ideal,” ill. ....	242	
	—Hungerford's patents .....	610	
	—Lidgerwood's .....	598	
	—Monitor .....	604	
	—Newell's .....	594	
	“Clear Drip” aluminum c.-pot....	633	
	Clearing Ass'n., N. Y. Exch. ....	357, 366	
	Clement VIII, Pope .....	22	
	Climate, Best for c. ....	134	
	—Brazil .....	152	
	—Colombia .....	162	
	—Guatemala .....	177	
	—Kenya .....	182	
	Closset, Emile .....	443	
	Closset, Joseph .....	432, 443	
	Closset & Devers .....	443	
	Closset Bros. ....	443	
	Cloves in coffee .....	625	
	Clubs		
	—Boston		
	—First (Merchant's) .....	107	
	Clubs (cont'd)		
	—London		
	—Court de Bone Compagnie..	55	
	—Evolution of .....	71	
	—Hanover .....	695	
	—Literary .....	701	
	—London coffee-house .....	525	
	—Bread Street .....	56	
	—Devil Tavern .....	56	
	—Friday Street .....	56	
	—Mermaid Tavern .....	56	
	—Rota .....	55, 56, 701	
	—Turk's Head .....	76	
	—White's .....	83	
	—New York		
	—Coffee House .....	571	
	—South America .....	571	
	—Phila., supersede c. houses....	126	
	<i>Clubs and Club Life in London</i> , q	690	
	Cluny Museum, Paris .....	718	
	Coal roasting .....	242, 579	
	Coarse (see grinds)		
	Coated c. ....	379, 622	
	Coatepec .....	201, 202	
	Coaua .....	33	
	Coava .....	33	
	Cobans c. ....	202	
	Cobbett, William; q.....	681	
	Cocktails, coffee .....	573	
	Cocoa, first used in Europe ....	21	
	Code descriptions		
	—Santos .....	335	
	Code of Fair Competition .....	409	
	Coelho, Maestro Antonio J. ....	194	
	Coffa .....	33, 35, 266	
	Coffalic acid .....	651	
	Coffao .....	266	
	Coffe .....	33, 266	
	<i>Coffea arabica</i> .....	127	
	<i>Coffea canephora</i> Pierre .....	173	
	<i>Coffea laurentii</i> Wild .....	173	
	<i>Coffea robusta</i> .....	127	
	<i>Coffea</i> (chanson) .....	712; ill. 715	
	<i>Coffee</i> , Keahle, q.....	316	
	<i>Coffee, A short historical account</i>		
	of .....	38	
	<i>Coffee and Coffee Making</i> , q	649	
	<i>Coffee and Cupid</i> (opera).....	717	
	<i>Coffee and Repartee</i> , q.....	684	
	<i>Coffee and Surrogates</i> .....	678	
	Coffee-bag ring .....	622, 653	
	Coffee bags, individual.....	657	
	Coffee Board of Kenya....	182, 262	
	<i>Coffee Book, The</i> , q.....	646	
	<i>Coffee cantata</i> .....	42, 712-716	
	<i>Coffee Club, The</i> , q....	315, 490, 493	
	Coffee Club of the Rota .....	55	
	<i>Coffee from Plantation to Cup</i> , q.		
	.....	316, 645	
	<i>Coffee Grinding and Brewing</i> ..	647	
	Coffee house, most beautiful, ill.	716	
	<i>Coffee House, The</i> , Goldini ....	24	
	<i>Coffee House, The</i> , Rousseau ...	84	
	<i>Coffee House Gazette</i> .....	70	
	<i>Coffee house or newsmongers'</i>		
	<i>hall</i> (hroadside) .....	64	
	Coffee-house keepers, London		
	—Proposed newspaper monopoly.	70	
	—Tokens, ill. ....	58, 59, 60, 723, 725	
	Coffee houses		
	—Algeria, ill. ....	538, 545	
	Coffee houses (cont'd)		
	—Arabia .....	540; ill. 542	
	—Augsburg, first .....	41	
	—Berlin		
	—Admiral's .....	566	
	—Arnoldi .....	41	
	—Bauer, ill. ....	566, 567	
	—City of Rome .....	41	
	—Des Westens .....	567	
	—English .....	41	
	—Falck's .....	41	
	—First .....	41	
	—“Groessenwahn” .....	567	
	—Josty's .....	566	
	—Kanzler's .....	566; ill. 567	
	—Miercke .....	41	
	—Royal .....	41	
	—Schmidt .....	41	
	—Victoria .....	566	
	—Widow Doebbert's .....	41	
	—Boston .....	104-109	
	—American .....	104-107	
	—British .....	104, 107	
	—Crown, ill. ....	104, 108	
	—Exchange, ill. ....	109	
	—First .....	104	
	—Green Dragon, ill. ....	106, 107	
	—Gutteridge .....	104	
	—London .....	104, 399	
	—North-End .....	108	
	—Royal Exchange .....	108	
	—Stage coaches start from		
	.....	106, 108	
	—Washington .....	106	
	—Brazil .....	573	
	—Cairo .....	22; ill. 539	
	—Chicago		
	—Exchange .....	102	
	—Lake Street .....	102	
	—Washington .....	102	
	—Colombia, ill. ....	575	
	—Constantinople .....	16	
	—Prices .....	16	
	—Damascus, ill. ....	551, 552	
	—Gate of Salvation .....	15	
	—Roses .....	15	
	—Denmark, ill. ....	562	
	—Ethiopia, ill. ....	543	
	—Exeter (Devon)		
	—Mol's .....	38	
	—France .....	464, 465	
	—Germany, ill. ....	43, 566	
	—First .....	41	
	—Hamburg .....	41	
	—Kranzler's .....	566; ill. 567	
	—Leipzig .....	41, 42	
	—Greece .....	567	
	—Italy .....	568	
	—First .....	23, 24	
	—Florian's, ill. ....	568	
	—London (coffee houses)—49, 85;		
	ill. 52, 56, 57, 59, 557, 558		
	—Adam's .....	679	
	—Baker's .....	83	
	—Baltic .....	83	
	—Bedford .....	75, 80, 83, 697	
	—Bowman's .....	79	
	—British .....	74, 82; ill. 84	
	—Button's .....	75, 76; ill. 77;	
	79, 80, 690, 694, 696		

# INDEX

797

PAGE	PAGE	PAGE
—London (coffee houses) ( <i>cont'd</i> )	—London (coffee houses) ( <i>cont'd</i> )	—Paris (coffee houses) ( <i>con'd</i> )
—Caledonien, <i>ill.</i> ..... 80	—Turk's Head, Canada and Bath ..... 701	—Foy, <i>ill.</i> ..... 92, 97
—Chapter ..... 75, 83, 700	—Virginia ..... 76, 79	—Gaieté ..... 95
—Cheshire Cheese, <i>ill.</i> ..... 687	—White's, <i>ill.</i> .. 74, 76, 83, 705, 706	—Grand Commun ..... 98
—Child's ..... 83, 679, 700	—Will's .. 73, 75, 76, 79, 80, 679, 694	—Guerbois ..... 100
—Cocoa-Tree ..... 74, 75, 83, 679	—Ye Mecca, <i>ill.</i> ..... 556	—Laurent ..... 99
—Decline of ..... 71	—Young Man's ..... 75	—Littéraire ..... 99
—Dick's, <i>ill.</i> ..... 83, 692	—Marseilles ..... 28	—Madrid ..... 99
—Dish of Coffee Boy, <i>ill.</i> 721, 725	—Morocco, <i>ill.</i> ..... 538, 539	—Magny's ..... 98
—Don Saltero's.... 76, 82; <i>ill.</i> 84; 678	—Netherlands ..... 40, 568	—Maire's ..... 99
—Edinburgh Castle ..... 71	—First ..... 39	—Maison Dorée ..... 99
—Elford's ..... 79	—St. Joris ..... 569	—Mapinot ..... 98
—Fire of 1666 ..... 57, 59, 79	—New England (First) ..... 104	—Massé's ..... 98
—First ..... 38, 49	—New Orleans ..... 102	—Méot's ..... 98
—Folly (bouse-boat) ..... 84	—New York (coffee houses)	—Momus ..... 97
—French, <i>ill.</i> ..... 85	—Auctions held at ..... 114	—Number of ..... 91
—Garraway's .... 53, 73, 76, 79; <i>ill.</i> 80; 681, 690	—Bank ..... 117, 120	—Paix, de la ..... 99
—Gaunt's ..... 706	—Brazil ..... 571	—Pascal's ..... 29, 88, 554
—George's, <i>ill.</i> ..... 691, 702	—Burns, <i>ill.</i> ..... 113, 117, 120	—Paris, <i>ill.</i> ..... 96, 99
—Giles's ..... 680	—City ..... 116	—Prévost ..... 566
—Grecian ..... 57, 76, 80; <i>ill.</i> 83; 679, 702	—Civic forums, use as... 111, 113, 114, 116	—Proope .. 89, 90, 91, 554; <i>ill.</i> ..... 565
—Groom's, <i>ill.</i> ..... 557	—Club of S. America ..... 571	—Rambuteau ..... 95
—Jamaica ..... 76, 79	—Decline ..... 120	—Régence ..... 93, 95
—Jenny Man's ..... 680	—Exchange ..... 114, 115, 116	—Riche ..... 99
—Jerusalem ..... 84	—First ..... 112	—Rocher de Cancale..... 100
—Joe's ..... 691	—Fleischmann's ..... 555, 571	—Rotonde ..... 97
—Jonathban's ..... 84, 692	—Gentlemen's Exchange .... 114	—Royal Drummer, <i>ill.</i> .. 86, 91, 93
—Kardomah ..... 558	—King's Arms .... 112, 113, 117, 120, 399	—Scala ..... 95
—Little Man's ..... 75	—Merchants, <i>ill.</i> .... 110; 114; <i>ill.</i> 115, 116, 118, 407	—Terre's ..... 99
—Lloyd's .... 76, 81; <i>ill.</i> 82; 692	—Congress of Deputies sug- gested ..... 116	—Tortoni ..... 99
—Locketts' ..... 689	—Memorial tablet, <i>ill.</i> .... 407	—Tour d'Argent ..... 91
—London ..... 84, 700	—New ..... 113	—Trois Frères Provencaux ... 98
—Man's ..... 84	—New England and Quebec. 118	—Vachette ..... 98
—Miles's ..... 55, 701	—Paulista ..... 571	—Venua's ..... 98
—Monico, <i>ill.</i> ..... 557	—Tontine ..... 116, 117, 118, 119	—Véry ..... 98
—Nando's ..... 75, 84, 692	—Whitehall ..... 117	—Voisin ..... 98
—Nero ..... 557	—Nuremburg ..... 41	—Persia ..... 17
—New England and North and South American ..... 84	—Oxford	—Philadelphia (coffee houses) 121-126
—New Lloyd's ..... 81	—Jacob's ..... 37, 38	—Decline of ..... 126
—New Slaughtbter's ..... 80	—Jobson's ..... 37	—Exchange ..... 126
—Number (1715) ..... 69	—Tillyard's ..... 37	—Exchanges, use as ..... 124
—Old Man's ..... 73, 75, 84	—Padua ..... 25	—First ..... 122
—Old Slaughter's ..... 80	—Pedrochi, <i>ill.</i> ..... 716, 717	—James ..... 123
—“On the Pavement” ..... 701	—Paris (coffee houses)..... 87-100	—London ..... 121, 122
—Peele's ..... 75, 84, 557, 703	—Alcazar d'Hiver ..... 95	—Slave auctions, <i>ill.</i> ..... 124
—“Penny universities”..... 69	—Anglais ..... 99	—London (2nd), <i>ill.</i> ..... 123, 124
—Percy ..... 84, 703	—Beauvilliers' ..... 98	—Merchants ... 121; <i>ill.</i> , 125; 126
—Piazza ..... 75, 84, 699	—Beginning of ..... 29	—Roberts' ..... 123
—Rainbow ..... 51, 59, 84, 692	—Biard ..... 566	—Social centers, use as..... 121
—Read's ..... 70	—Chartres ..... 98	—Ye Coffee House... 121, 122, 399
—Red Cow ..... 79, 694	—Chat Noir ..... 100	—Post office, use as..... 122
—Robins's ..... 691	—Concert du XI Siecle..... 95	—Regensburg, first ..... 41
—Rochford's, Mrs. .... 74	—Concert Européen ..... 95	—Scandinavia ..... 569
—Rose ..... 52, 79, 694	—de la Paix, <i>ill.</i> ..... 563, 566	—St. Louis ..... 101
—Rosée's ..... 38	—de la Regence, <i>ill.</i> ..... 564, 566	—Stuttgart, first ..... 41
—Shakespeare ..... 80	—Des Mille Collones, <i>ill.</i> .... 94	—Syria, <i>ill.</i> ..... 550
—Slaughter's .. 75, 76, 80, 81, 701	—Development of ..... 91	—Turkey ... 15, 16; <i>ill.</i> 17, 546, 547
—Smyrna ..... 74, 75, 84, 692	—Durand ..... 99	—Venice (coffee houses)
—Squire's ..... 82	—Dutch ..... 99	—Abbondanza ..... 24
—St. James's .. 71, 74, 75, 76, 84, 693	—Eldorado ..... 95	—Angelo Custode ..... 24
—Stone's ..... 558	—English ..... 99	—Arabo-Piastrelle ..... 24
—Thomas's ..... 80	—Fevrier's ..... 98	—Arco Celeste ..... 24
—Tom King's .. 84, 698, 705, 707	—First ..... 523	—Aurora Piante d'oro ..... 24
—Tom's .... 75, 76, 80; <i>ill.</i> 81; 697	—Folies Bobino ..... 95	—Buon genio-Doge ..... 24
—Turk's Head .... 52, 55, 75, 76, 84, 700, 701		—Coraggio-Speranza ..... 24
		—Dame Venete ..... 24
		—Duca di Toscana ..... 24
		—Florian ..... 23, 24; <i>ill.</i> 25
		—Fontane di Diana ..... 24

PAGE		PAGE		PAGE
	—Venice (coffee houses) ( <i>cont'd</i> )	Coit & Son, Henry .....	412	Consumption ( <i>cont'd</i> )
	—Imperatore Imperatrice della	Coke roasting .....	239, 242	—Brazil .....
	Russia .....	Colaux & Cie. ....	585	—Canada .....
	—Menegazzo .....	Cole, Samuel .....	104, 105	—Cbile .....
	—Orfeo .....	Cole & Son, Stephen .....	411	—Colombia .....
	—Pace .....	Coleman, Philip H. ....	425	—Cuha .....
	—Pitt. l'eroe .....	Coles Manufacturing Co. ....	615	—Denmark .....
	—Ponte dell' Angelo .....	Colet, M. H., <i>q.</i> .....	712, 715	—Europe .....
	—Quadri .....	Colgate, Charles C. ....	427	—Table .....
	—Redentore .....	Colgate, Samuel .....	427	—Finland .....
	—Re di Francia .....	<i>Collection of Voyages and Trav-</i>		—France .....
	—Regina d'Ungheria .....	<i>els, A, q.</i> .....	19	—Germany .....
	—Spaderia .....	Colombia, geographical position...	161	—Greece .....
	—Tamerlano .....	Colombia Broadcasting System...	482	—Hungary .....
	—Venezia trionfante .....	Colombians <i>c.</i> .....	127, 129, 203	—Italy .....
	—Vienna (coffee houses) .....	Colonos .....	153	—Netherlands .....
	Blue Bottle .....	Columbian Enameling & Stamping		—New Zealand .....
	First .....	Co. ....	621	—Norway .....
	Kolschitzky's .....	Columbia University .....	299	—Portugal .....
	Künstler, <i>ill.</i> .....	<i>Columbian Centinel, q.</i> .....	108, 471	—Puerto Rico .....
	Mosee's, Franz .....	"Columbian" enamel drip <i>c.</i> -pot..	633	—Russia .....
	Number of (1839) .....	<i>Columnaris c.</i> .....	278	—Salvador .....
	Sacher .....	"Comet Dripolator" aluminum drip		—Spain .....
	Schrangl, <i>ill.</i> .....	<i>c.</i> -pot .....	633	—Sweden .....
	Victoria, <i>ill.</i> .....	Comité Français du Café.....	488	—Switzerland .....
	Young Men's, <i>ill.</i> .....	Commercial coffee chart .....	129	—Tables and Charts of per capita
	—(See also Hotels, Restaurants,	Commercial coffees of the world		495, 520, 521
	Taverns)	127-129		—Table of world .....
	<i>Coffee houses vindicated, q.</i> .....	Commercial Importing Co. ....	446	—Tea and <i>c.</i> comparisons.....
	Coffee Industries Com.....	Commissario .....	327, 333	—Chart .....
	<i>Coffee, Its History, Cultivation and</i>	Committee of One Hundred.....	116	—Tobago .....
	<i>Uses</i> .....	Compact Coffee Corp. ....	621	—Trinidad .....
	Coffee kings	Companhia Cafeeira de Minas		—Union of South Africa .....
	—Germany .....	Geraes .....	159	—United Kingdom .....
	—U. S. ....	Companhia de Armazens Geraes. 159		—United States.....
	Coffee-makers' guild of Vienna..	Complet, Café .....	565	—Per capita table and Chart
	<i>Coffee man's granado, The</i> (hroad-	Complete Reference Table... 212-232		529, 531
	side) .....	Con léche, Café .....	573	Containers .....
	Coffee <i>moe</i> .....	Conditioning .....	355	—Cartons .....
	Coffee palaces ( <i>see also</i> Coffee	Condorcet .....	91	—Color preference .....
	houses) .....	Confection		—Fibre cans .....
	Coffee Pep (hrand) .....	—Used as .....	623, 625	—Glass jars .....
	Coffee pots ( <i>see also</i> Service)	<i>Confessions</i> .....	98	—Machinery for filling.....
	—Bagdad .....	<i>Congensis c., ill.</i> .....	277; 283	—Paper bags... 256, 257, 374;
	—Early New England, <i>ill.</i> ...105, 106	<i>Congensis var. Chalotii</i> .....	283	<i>ill.</i> .....
	—Early New York, <i>ill.</i> .....	<i>Congensis x Ugandae</i> .....	283	376, 403; 427
	—Straining devices .....	Congo, Belgian, <i>c.</i> .....	172	—Tests .....
	—Sweden, <i>ill.</i> .....	Conkling & Lloyd .....	411	—Tin cans .....
	Coffee powder .....	Conopios, Nathaniel .....	36, 37, 39	—Vacuum tins and jars... 256,
	Coffee Products Corp. ....	Conrad & Co., J. H. ....	437	257, 375-377
	Coffee Products of America, Inc. 446	Consolidated Coffee Co. ....	444	Continental Can Co. ....
	Coffee Roaster & Mill Mfg. Co....	Consortium of 1868 .....	412	262, 657
	<i>Coffee scuffle, The</i> (broadside), <i>q.</i>	Constantine, George ( <i>see</i> Jennings,		Contracts
	<i>q.</i> .....	Constantine)		—Cost-and-freight .....
	Coffee-smellers (Germany) .....	Constantinople, <i>ill., q.</i> .....	547	—"Good-faith" clause.....
	Coffee stalls, <i>ill.</i> .....	Constantinople in 1657, <i>Relation of</i>		352, 362
	<i>Coffee, tea, and chocolate, Con-</i>	<i>a Journey to, q.</i> .....	19	—Guaranteed .....
	cerning the use of .....	Constants in <i>c.</i> .....	294	—N. Y. Exchange.. 348, 350, 357, 359
	<i>Coffee, tea, and chocolate, The</i>	Constituents of <i>c.</i> .....	293	—To arrive .....
	<i>manner of making</i> .....	—Effect on, by roasting.....	651	352, 362
	Coffee Trade Association of Kenya 182	<i>Constitutional Antiquities of</i>		Controversies ( <i>see</i> Opposition)
	Coffee Trade Association of Lon-	<i>Sparta and Athens, q.</i> .....	36	Conway, Charles .....
	don .....	Consumo (grade)		Cooling .....
	426	—In blends .....	251, 252	—In wicker baskets .....
	Coffee vender (Paris), <i>ill.</i> 88; 89	Consumption .....	517-534	Cooling machines
	Coffee water .....	—Argentina .....	519, 523	—Burns's .....
	"Coffelator" aluminum vacuum <i>c.</i> -	—Australia .....	519, 523	—Emmerich automatic .....
	pot .....	—Austria .....	522	—"Stirflex," <i>ill.</i> .....
	633	—Balkan States .....	522	245, 247
	Coffey .....	—Belgium .....	521, 522, 527	Cooper, Charles, <i>q.</i> .....
	Cognac in <i>c.</i> .....			558
	Coho .....			Cooper, Cornelius .....
	33, 35, 265, 266			427
	Cohove .....			Cooper, J. W. ....
	87			439
	Çöbu .....			Cooper & Co., Nathaniel .....
	266			411

# INDEX

799

PAGE		PAGE
<p>Copeland, Dr. Royal S., <i>q.</i>..... 318  Copha .....35, 265, 266  Corbett, Barney ..... 439  Cordoba <i>c.</i> .....201, 202  Corey, Harvey C..... 622  Corning Glass Works ..... 622  Cornell &amp; Smith ..... 444  Corners  —Arnold's ..... 447  —Blanco's ..... 457  —Kaltenbach's ..... 457  —Sielcken's ..... 449  Cost analysis ..... 372  Cost and freight brokers..... 367  Cost and freight purchases  —New York ..... 350  Cost and profits, retail..... 395  —Chart ..... 396  Cost card for roasters ..... 247  Costa Ricas <i>c.</i> .....128, 129, 203  Coste, Felix .....408, 490, 493  Cotovicus .....16, 27, 626  Cottraux, E. P. .... 440  Cottrell ..... 431  Couha ..... 266  Cougnet, Dr. A., <i>q.</i> ..... 22  Coventry, Sir William, <i>q.</i> ..... 68  Cowha ..... 266  Cowhe ..... 266  Cowper, William .....669, 676  Cramer, P. J. S., <i>q.</i>...201, 277,  278, 279, 281, 283  Crawford, Thomas A. .... 440  Crawley, Edwin ..... 606  "Cream City" enamel percolator.. 633  Cream in coffee.....308, 313, 570  —Effect of ..... 313  Crébillon ..... 91  Creighton, Clarence .....412, 417  Creighton &amp; Ashland ..... 413  Creighton, Morrison &amp; Meehan  412, 413  Creme, Café à la.....565, 641  Crescent Mfg. Co. .... 446  Crispe, Sir Nicholas ..... 51  Crocker, Nathaniel ..... 444  Crooks &amp; Co., Samuel ..... 435  Crop periods (<i>see</i> Harvesting)  Crosby, Chas. L. W..... 426  Cross, Frederick J. .... 621  Cross &amp; Co., C. A. .... 605  Crossman, George W....415, 417, 449  Crossman, W. H. ....417, 449  Crossman &amp; Bro., W. H....417,  448, 457  Crossman &amp; Sielcken...417, 449, 450  Crouse &amp; Co., Jacob ..... 444  Cruger, Henry ..... 411  Cruger, John ... ..... 411  Crusade (hrand) ..... 472  Cuban <i>c.</i> ..... 206  Cúcutas <i>c.</i> .....127, 128, 203, 204  Cultivation (geographical)  —Abyssinia .....1, 133, 169, 170  —Africa, British Central ..... 5  —Africa, British East ..... 5  —Angola ..... 170  —Arabia .....133, 134; <i>ill.</i>, 168, 171  —Began ..... 1  —Early implements used, <i>ill.</i>... 134  —Argentina ..... 173</p>	<p>Cultivation (geographical) (<i>cont'd</i>)  —Australia ..... 172  —Belgian Congo, <i>ill.</i> .....171; 172  —Bolivia ..... 173  —Bourbon (Réunion) ..... 5  —Brazil .....5; <i>ill.</i>, 142; 149–159  —Coffee-growing areas ..... 151  —First ..... 501  —Introduction of plant ..... 149  —Restriction ..... 460  —British Honduras ..... 173  —Celebes ..... 5  —Ceylon ..... 173  —Begun by Arabs ..... 2  —Begun by Dutch .....2, 39  —Chile ..... 173  —Colombia .....161–167  —Costa Rica .....5, 173  —Cuba .....5, 173  —Dominican Republic ..... 174  —Ecuador ..... 174  —Eritrea ..... 174  —Federated Malay States..... 187  —France ..... 2  —French Cameroons ..... 175  —French Colonies ..... 174  —French Equatorial Africa ... 175  —French Indo-China .....5, 175  —French W. Africa ..... 177  —Guadeloupe ..... 177  —Guatemala, <i>ill.</i> .....176; 177  —Guiana, British ..... 179  —Introduction ..... 506  —Guiana, Dutch ..... 179  —Guiana, French ..... 179  —Haiti .....5, 179  —Hawaii .....5, 180  —Honduras ..... 181  —India .....5, 194  —Begun by English ..... 1  —Jamaica .....5, 70, 181  —Kenya, <i>ill.</i> .....180; 182  —Liberia ..... 182  —Madagascar ..... 183  —Malaya ..... 187  —Martinique ..... 183  —Introduction into .....2, 4  —Mexico .....5, 184  —Netherlands Indies .....187, 188  —New Caledonia ..... 189  —Nicaragua ..... 189  —Nyasaland ..... 190  —Pacific Islands ..... 191  —Panama .....190, 191  —Paraguay ..... 191  —Paraná ..... 151  —First ..... 151  —Peru ..... 192  —Philippines .....5, 192  —Puerto Rico .....5, 193  —Queensland ..... 5  —Rio de Janeiro ..... 149  —Salvador .....5, 193  —São Paulo ..... 149  —Santo Domingo ..... 5  —Tanganyika ..... 195  —Tobago ..... 195  —Trinidad ..... 195  —Uganda ..... 195  —United States ..... 5  —Uruguay ..... 173</p>	<p>Cultivation (geographical) (<i>cont'd</i>)  —Venezuela .....5, 196  —Introduction ..... 503  —Western Hemisphere  —Introduction ..... 526  Culver &amp; Geiger ..... 445  Cummings, W. A. .... 431  <i>Cup of Coffee, A</i> (broadside), <i>q.</i> 61  Cup-testing .....210, 252–256  —Blind ..... 210  —Equipment, <i>ill.</i> .....209, 211, 252  —New York, <i>ill.</i> ..... 209  —Rohusta <i>c.</i> ..... 282  Cupping (<i>see</i> Cup-testing)  Cure-all ..... 471  <i>Curiosities of Literature, q.</i>...37, 87  Curtis &amp; Burnham ..... 444  Curtis Publishing Co. .... 494  <i>Customs and Fashions in Old New  England, q.</i> ..... 642  Cutler, Benjamin ..... 427  Cuyler, Philip ..... 411  Cyrill, Patriarch .....36, 37</p>
<h2 style="margin: 0;">D</h2>		
<p>da Fonseca, Father Antonio Lopes. 149  da Ponte, Lorenzo..... 24  Dagoty ..... 707  Dahlman, Henry ..... 442  Dahlman, John ..... 442  Dairies, coffee in..... 555  Dakin, William and Elizabeth.... 592  Dakin &amp; Co. .... 593  D'Alembert <i>q.</i> ..... 267  Dally, Gifford ..... 124  Dal-Tex Coffee Co. .... 446  Damaged coffee ..... 349  Damrau, Dr. Frederic, <i>q.</i>..... 319  Dana, John Cotton, <i>q.</i>..... 645  Daney, Sidney, <i>q.</i>..... 4  Dannemiller, A. J.  —Coffee-selling chart ..... 373  Dantas, José Luiz..... 146  Danton, Georges Jacques..... 91  Danvers's <i>Letters, q.</i>..... 266  "Dark heat" ..... 146  d'Arvieux, Chevalier, <i>q.</i>..... 18  Dash, Bowie.....403, 414, 433, 455  Dash, J. Bowie ..... 433  Dash &amp; Co., Bowie.....403, 404,  413, 414, 456  Dated coffee ..... 434  Dater, Henry ..... 417  Dater, Philip ..... 417  Dater &amp; Co., Philip..... 417  Daudet, Alphonse ..... 98  Daugleish, Dr. .... 559  Daughty, Charles M., <i>q.</i>..... 544  Davenant, Sir William ..... 76  Davies &amp; Co., John L..... 437  Davis, S. L. .... 434  Davis &amp; Co., Noah..... 436  Davison &amp; Murphy ..... 425  Dawson, August T., <i>q.</i>..... 644  Dayton &amp; Co. .... 417  Dayton Spice Mills Co.....444, 446  de Andrade, Antonio Francisco.. 151  De Belloy, Jean Baptiste..91, 581,  582, 627  de Boze, <i>q.</i>..... 663</p>		

	PAGE		PAGE		PAGE
de Bussy, Tb. Roland, <i>q.</i>	538	Descamps	708	Downer, Samuel A.	437
de Chirac	2	Desmoulins, Camille	91, 97	Downer & Co.	437
de Clieu, Matbieu Gabriel	2-5, 184	Desserts, recipes	644	Downtown Assn., New York	447
—Voyage to Martinique	2, 3	Destree, <i>q.</i>	311	Drake, Samuel Gardner, <i>q.</i>	104, 112
<i>De Constantinople à Bombay</i> , Lettres, <i>q.</i>	8	Déverall, R. R. & A.	437	Drake & Co., W. D.	442
de Coverley, Sir Roger	82	Devers, A. H.	432, 443	Dramatic literature, coffee in	674-676
de Goncourt, Jules	98	<i>Dewevre c.</i>	279	Draper & Co., John H.	419
de Gourcuff, O.	677	Dexter, C. J.	442	Drew, J. C.	440
De Groot, Perry A.	622	<i>Diary, Jourdain, q.</i>	266	Driers	146
de Jour, Rouillé	4	<i>Diary and Correspondence of John Evelyn, q.</i>	36	—"Guardiola"	146; <i>ill.</i> 602; 603
de Jussieu, Antoine	2	Dickinson, Gilchrist	411	—"O'Krassa"	146; <i>ill.</i> 605
<i>De la Café</i>	677	Diderot, Denis	91, 93, 95	—Henckel's	581
de la Cour, J. Carl	445	Diefenthaler, Charles E.	433	—McKinnon's, <i>ill.</i>	602
de la Haye	27	Diefenthaler, G. E.	433	—Squier, <i>ill.</i>	602
de la Roque, P.	27	Dietary, <i>c.</i> in the	316	—Scolfield's	603
de Lannay, Count	42	Dietl	312	—Villavicentio	621
de Laval, Pyrad, <i>q.</i>	266	Dietz, F. C.	444	Drink ( <i>see</i> beverage)	
de Lavradio, Marquis	149, 151	Digestion, effect of <i>c.</i> on	317	Drinks (brand)	453
de l'Écluse, Charles	27	Digitalis, <i>c.</i> supplants	319	Drip coffee pots, modern, <i>ill.</i>	632
De Lessert & Co., J. S.	411	Dilworth & Co., J. S.	443	Drip coffee recipe	649
De Lima, D. A.	417	Dilworth Bros.	443, 472	"Drip-Drop" aluminum drip pot	633
De Lima, D. A. & J.	417	Dimethyl xanthin	296	"Dripette" aluminum drip <i>c.</i> -pot	633
De Lima & Co., D. A.	417	Dimond & Gardes	417, 421	"Drip-o-Lator" aluminum drip pot	633
<i>De l'usage du caphe du thé et du chocolat</i>	663	Dimond & Lally	417	"Dripmaster" aluminum drip <i>c.</i> -pot	633
de Lorena, Bernardo José	149	Discovery of <i>c.</i> ( <i>see</i> origin)		Droste, H. H.	438
de Mattei, Natale	620	Diseases and Pests	141	Droste, H. R.	439
de Mello, Correa	151	— <i>Anestia variegata</i>	182	Drouais, Francois Hubert	707
de Mello Palheta, Francisco	149	— <i>C.</i> -leaf miner	141, 284	Drums ( <i>see</i> containers)	
de Menezes, Theodore Langgaard	490	—Eel-worm disease	141	Drunkness, cure for	54
de Monteith, Fulbert, <i>q.</i>	13	—Fungoid	141, 284	Dry method of preparation	142, 143, 155
de Musset, Alfred	93, 98, 99	— <i>Hemileia vastatrix</i>	141, 183, 285, 290, 291	—Brazil	155
de Noailles, Duke	686	—Insects	141	—Colombia	164
de Nointel	662	—Iron rust	163	Dryden, John	73, 75, 79, 80
de Paulo Camargo, Francisco	151	—Mediterranean fruit fly	141	Drying	144, 145; <i>ill.</i> 156, 157, 165
de Pompadour	706, 708, 718	— <i>Pellicularia tokeroga</i>	284	—Plants in Brazil	159
De Quincey, Thomas, <i>q.</i>	682	—Root disease	141, 285	Drying grounds	145; <i>ill.</i> 146, 176, 180, 186, 189, 196
de Sacy, Baron Antoine Isaac Silvestre	13, 267, 546	— <i>Sphaerostilbe flavida</i>	141	Du Barry, Madame, <i>ill.</i>	88, 683, 685, 706
<i>De Saluberrima Cahue seu Café, etc.</i>	12	—Spot of leaf and fruit	285	Du Tour, <i>q.</i>	640
de Santais, Edward Loysel	587	— <i>Stephanoderes hempei, ill.</i>	141, 146, 163	Dubard, Prof., <i>q.</i>	284
De Sarlo <i>q.</i>	311	— <i>Stilbium flavidum</i>	285	Dublin <i>Philosophical Journal, q.</i>	637
de Sévigné, Madam, <i>q.</i>	87, 684	Displays, <i>ill.</i>	395	Ducis	668
de Thévenot, Jean	27, 87	D'Israeli, I.	37, 49, 68, 87	Dufougeret-Grenier	5
de Tournemine	708	Distillation devices		Dufour, Pbilippe Sylvestre, <i>q.</i>	7, 9, 11, 30, 69, 95, 266, 470, 471, 580, 625, 663
de Wildman, M. E., <i>q.</i>	270	—Napier-List	631	Dumant, Pierre Etienne Louis, <i>q.</i>	9
Dearborn Coffee Co.	466	—Napierian	601	Duncan, James, <i>q.</i>	54
Dearborn Soluble Coffee	466	—Napier's vacuum, <i>ill.</i>	598, 629, 631	Duncan Coffee Co.	446
Dearman, Richard	580	—Wyatt's patent	581, 629	Duncombe Mfg. Co., F. A.	617
Decaffeinated ( <i>see</i> Caffeine-free)		Districts ( <i>see</i> also Complete Reference Table)		Dunham, Charles A.	444
<i>Declaration du Roi concernant la vente du café brûlé (coffee ordinance)</i>	42	—Arabia	171	Dunks, John	114
Declaration of Independence	107	—Brazil	151, 152	Duparquet, L.	601
Decoction		—Colombia	162, 335	Duparquet, Huot & Moneuse Co.	601, 610
—Defined	628	—Dominican Republic	174	Durand, H. C. & C.	437
—Use of	524	—Ecuador	205	Durand & Kasper	437
Decreuse	707, 709	—French Indo-China	175	Durand & Casper Co.	437
Deer Co., A. J.	404, 607, 615	—Guatemala	177	Durand-McNeil-Horner Co.	437
Defects		—Hawaii	180	Durant, Nicholas Felix	585, 629
—Brazil, table	334, 335	—Honduras	181	Duryee, P. S., <i>q.</i>	388
—New York	359	—India, S.	194	<i>Dutch New York, q.</i>	101, 111, 642
Defendorf, George	427	—Java and Sumatra	127	Dutch West India Co.	101
Defes	711	—Kenya	182	Duties	
Defoe, Daniel	74, 75, 76	—Mexico	128, 184	—Export, Brazil	329, 334, 461, 462, 489, 493
Dehio	312	—Nicaragua	189	—Import	
Deiningering & Co., Ray	425	—Panama	191, 215	—England	55, 70, 357
"Dekafa"	405	—Salvador, El	194, 214	—Ethiopia	342
Del Monte <i>c.</i> advertising, <i>ill.</i>	496	—Venezuela	197	—United States	400, 401, 403, 528
Delafield, Henry	403, 412	Ditson, Thomas	585	Duvaux, Lazare	718
Delafield, Herbert	406, 409, 437	Dittman, Charles	421	Dwight, H. G., <i>q.</i>	547
Delafield, William	412	Dittman Co., Chas.	421	Dwinell, James F.	430, 436
Delille, Jacques, <i>q.</i>	667	Diuretic, <i>c.</i> as a	307	Dwinell & Co.	436
Delivery-route dealers		Divination by coffee grounds	678	Dwinell, Hayward & Co.	436
—France	563	Divorce, coffee and	18	Dwinell-Wright Co.	436, 589
Dell, John C.	610	DNC	159	Dybowski, <i>c.</i>	281
Della Valle, Pierre	8, 23, 266	D'Olivet	663	Dybowski x <i>excelsa</i>	283
Delphine, Sr.	601	Doane & Co., J. W.	417	Dyer & Co.	436
Demerara <i>c.</i>	205	Dolton & Co., Wm.	444	Dykes & Wilson	416
Demidoff, Prince	99	<i>Domestick Coffee Man, q.</i>	525, 627		
Demi-tasse	557, 563, 573, 575	Dominguez, Andres	184		
Demonstrations, etc., Store	380, 393; <i>ill.</i>	Dominican <i>c.</i>	206		
Dennison, T. W.	431	Donmartin	580, 627		
Denobe	581, 628	Donovan, Prof., <i>q.</i>	637		
Dent, Edw. J.	622	Donns, <i>q.</i>	4		
Deodorant	54	Doran, John, <i>q.</i>	639		
Departamento Nacional do Café, 159, 323, 327, 334, 409, 462,	527	Doremus, Geo. W.	435		
Dern Co.	446	Dorn, R. H.	440		
Des Arts & Henser	412	Dorr, S. H.	419		
		Dorsay, Benjamin	400		
		Douglas, James (Bishop of Salisbury)	38, 82, 663		
		Dowling, Dr. Oscar, <i>q.</i>	317		

## E

Eagle Coffee and Spice Mills	438
Eagle Spice Co.	442
Eagle Spice Mills	439
Eames, Wilberforce	407



# INDEX

801

	PAGE		PAGE
Earle, Alice Morse, <i>q.</i> .....	642	Esménard, <i>q.</i> .....	4, 668
Early History of Coffee Houses in England, <i>The, q.</i> .....	7	Esperanza Coffee Co. ....	433
East India Co. <i>c. pot, ill.</i> .....	718, 719	Essex Institute .....	105
East Indian <i>c.</i> .....	208	Essmueller Mill Furnishing Co. ....	617
Ebinger, E. ....	297	Estates ( <i>see</i> plantations)	
Eccles, William .....	411	Estienne, Jacques .....	668
Echavarria Inc. ....	425	Etablissements Lauzaune ( <i>see</i> Lauzaune)	
Ecuadors <i>c.</i> .....	205	Etherege, Sir George .....	689
Eddy, Dr. Walter H. ....	299, 301, 378	Ethiopian <i>c.</i> .....	129, 169, 207
Eddy & Co., L. B. ....	444	Ethridge, Tuller & Co. ....	444
Edison Elec. Appliance Co. ....	621	Etiquette ( <i>see</i> Manners and cus- toms)	
Edmond .....	98	Etruscan Coffee Pot Co. ....	613
Edmonds, John W. ....	418	Etyymology .....	265-267
Edtbauer, P. E. ....	405	Evans, David G. ....	432, 438
Edthauer weighing machine, <i>ill.</i> 257; 405		Evans, Gwynne .....	438
Edwards, Daniel .....	49	Evans, Richard .....	584
Edwards, Hugh .....	417	Evans & Co., David G. ....	438
Edwards, J. H. ....	425	Evans & Walker .....	444
Edwards, J. M. ....	416	Evelyn, John, <i>q.</i> .....	36, 266
Edwards, Dr. Martin, <i>q.</i> .....	317	<i>Evening World</i> , New York, <i>q.</i> ..	673
Edwards & Co., Dwight .....	443	Evletb, Earl M. ....	622
Edwards & Co., J. M. ....	416	Ev-Ry-Da (brand) .....	466
Edwards & Maddux .....	403, 416	Ewell, <i>q.</i> .....	293
Edwards & Raworth .....	417	Ex-sailing ships .....	344
Edwards Co., Wm. ....	443	<i>Excelsa c., ill.</i> .....	276, 278; 279
Edwards, Townsend & Co. ....	442	<i>Excelsa x liberica</i> .....	283
"Efcolite" china and aluminum drip <i>c.-pot</i> .....	633	Excelsior Co. for the Roasting and Conservation of Coffee	237
Ehrman, S. Mason .....	443	Excelsior Mills .....	437
Ehrman, Wm. H. ....	443	Exchanges, coffee .....	357
Eiffel Tower, <i>ill.</i> .....	498	—Aden .....	343
Ekelund, Charles .....	440	—Amsterdam .....	426
<i>Electuary of Cophy, q.</i> .....	53	—Antwerp .....	426
Elephant (grade) .....	147	—Baltimore .....	426
Elford the younger, <i>q.</i> .....	57	—Bogota .....	338
Elkington & Co., Ltd. ....	601, 629	—European .....	527
Ellis, H. D. ....	721	—Hamburg .....	426
Elmenhorst & Co. ....	417	—Harar .....	342
<i>Elogé de Massieu</i> .....	663	—Havre .....	357, 426, 521
Ely & Co., D. J. ....	403, 416	—London .....	426
Ely & Co., D. J. & Z. S. ....	416	—Rio de Janeiro .....	325
Embryo .....	289; <i>ill.</i> 290	—Santos .....	331
Emerson .....	294, 297, 299	—New York .....	198, 327, 357-366
Emerson, E. ....	436	—Board of Managers .....	364
Emerson, Edward R., <i>q.</i> .....	686	—Change of name .....	362, 407
Emmerich Machine Factory and Iron Foundry .....	239, 454, 599	—Clearing Assn. ....	357, 366, 407
Empire State Bldg., <i>ill.</i> .....	498	—Commissions .....	365
<i>Encyclopædia Britannica, q.</i> .....	7, 135, 540	—Contract .....	348, 350, 357
<i>Encyclopædia der Therapie, q.</i> ..	311	—Functions .....	362, 363
<i>Encyclopædia of Domestic Econ-</i> <i>omy, q.</i> .....	638	—Government control, 1918 ..	370, 464
<i>Encyclopædia of Practical Cook-</i> <i>ery, q.</i> .....	642	—Houses of trading .....	367
Endocarp, <i>ill.</i> .....	288, 289, 290	—Incorporated .....	362, 403, 426
Endosperm .....	289, 295	—Initiation fee .....	364
Engelberg, Evaristo C. ....	603	—Jubilee .....	409
Engelburg Huller Co. ....	603	—Membership .....	364
Engelhard, Albert .....	440	—Organized .....	456
Engelhard, Jr., Albert .....	440	—Robusta rulings .....	370
Engelhard, George .....	440	—Seats, sales of .....	364
Engelhard, R. W. ....	440	—Superintendent .....	364
Engelhard, Victor H. ....	440	—Wartime suspension .....	407, 462
Engelhard & Sons, Inc., A. ....	440	—Rotterdam .....	426
English, Dr., <i>q.</i> .....	315	—San Francisco .....	426
<i>English Factories in India, q.</i> ..	266	—Santos .....	426
Ennis, F. Robert .....	439	—Trieste .....	426
Ennis, Frank .....	439	<i>Excursions through Asia Minor, q.</i>	551
Ennis, George A. ....	439	Exhibits, educational, <i>ill.</i> .....	483
Ennis-Hanly-Blackburn Coffee Co.	439	Experimental gardens ( <i>see</i> gar- dens)	
Enright, Daniel M. ....	418	Exports .....	
Enright, Stephen P. ....	621	—Arabia .....	511
Enterprise Aluminum Co. ....	622	—Bolivia .....	507
"Enterprise" aluminum drip <i>c.-</i> <i>pot</i> .....	633	—Borneo, Brit. North .....	514
Enterprise Coffee Co. ....	443	—Brazil .....	501
Enterprise Mfg. Co. of Pa. ....	601, 615	—Chart .....	503
Epicarp, <i>ill.</i> .....	288	—First .....	149, 501
<i>Epicure</i> .....	558	—British Guiana .....	506
Eppens, Frederick P. ....	417, 435	—British Malaya .....	514
Eppens, Julius A. ....	418, 431, 435	—Ceylon .....	512
Eppens, William H. ....	417, 428, 435	—Colombia .....	504, 505
Eppens, Smith & Wiemann. ....	417, 431, 435	—First .....	161
Eppens, Smith Co. ....	417, 429, 431, 435, 612	—Costa Rica .....	508
Erdmann, <i>q.</i> .....	299	—Cuba .....	510
<i>Erecta c.</i> .....	278	—Dominican Republic .....	174, 509
Erie Canal .....	420	—Dutch Guiana .....	506
Escoffier (chef) .....	560	—Ecuador .....	505
Escott, <i>q.</i> .....	83	—Ethiopia .....	515
		—Federated Malay States .....	514
		—French Equatorial Africa .....	175
		—French Guiana .....	506
		—French Indo-China .....	175
		—French W. Africa .....	177
		Exports ( <i>cont'd</i> ) .....	
		—Grenada .....	511
		—Guadeloupe .....	177, 510
		—Guam .....	514
		—Guatemala .....	177, 507, 508
		—Haiti .....	509
		—Hawaii .....	514
		—Honduras .....	508
		—India .....	512
		—Jamaica .....	509
		—Java .....	513
		—First .....	526
		—Leeward Islands .....	511
		—Mexico .....	508
		—Netherlands Indies .....	512
		—New Caledonia .....	189
		—New Hebrides .....	189
		—Nicaragua .....	508
		—Nigeria .....	517
		—Nyasaland .....	190, 515
		—Panama .....	508
		—Peru .....	505
		—Philippines .....	192, 514
		—Producing countries (chart and table) .....	502, 507
		—Puerto Rico .....	510
		—Réunion .....	517
		—Salvador .....	507
		—Sierra Leone .....	517
		—Somali Coast (French) .....	517
		—Somali Protectorate .....	517
		—Straits Settlements .....	514
		—St. Vincent .....	511
		—Sumatra .....	513
		—Tanganyika Territory .....	515
		—Tobago .....	195, 511
		—Trinidad .....	195, 511
		—Venezuela .....	503, 504
		Extract machine .....	599, 613
		Extracts .....	258, 553, 571
		—Romero's patent .....	620
		Eyre, Henry .....	417

## F

<i>Faba Arabica, Carmen</i> .....	663
Factory preparation .....	233-262
Fairy Cup (brand) .....	466
Fakr-Eddin-Aboubeckr ben Abid Iesi .....	663
Falck, Philipp, <i>chk.</i> .....	41
Faneuil, Peter .....	728
Fantastic claims for <i>c.</i> .....	54
Farm Board, U. S. ....	408
Farr, James .....	49, 51, 59
Farrell, C. P. ....	444
Farrington Campbell & Co. ....	444
Fat content in <i>c.</i> 293, 294, 377; 623	
"Father of English coffee houses" .....	35, 51
Faulder, H. ....	604
Faust (brand) .....	466, 478
Fazenda (brand) .....	488
Fazendas ( <i>see</i> Plantations)	
Federação Paulista das Coopera- tivas de Café .....	159
Federacion Nacional de Cafeteros. 162, 163, .....	166
Fell & Bros., C. J. ....	437
Fellon .....	663
Fellows, <i>q.</i> .....	551
Fenjejl, Fen'eyns, or Fenjyn ( <i>see</i> Fin-djans)	
Fere, <i>q.</i> .....	312
Fermentation .....	145
—Dry .....	145
—Wet .....	145
Fermentation tanks, <i>ill.</i> .....	160, 186
Ferrari, Mary .....	114, 115
Ferris, P. J. ....	444
Fertilizing .....	137
—Brazil .....	154
—Colombia .....	163
Field, Frank O. ....	405, 408
Fielding, Henry .....	75, 76, 84, 674
Fillers .....	258
—Italy .....	568
Filter bags .....	
—Care of .....	646
—Vs. filter paper .....	647, 648
Filter paper .....	647, 648
Filtration .....	628
—Definition .....	

	PAGE		PAGE		PAGE
Filtration ( <i>cont'd</i> )		Flanders & Co., Geo. W.	418	Fromm & Co.	417
—Methods	647	<i>Flasks and Flagons, q.</i>	672	Frost, damage by	408, 463
—N.C.R.A. recommendations	647	Flat-bean Santos <i>c.</i>	199; <i>ill.</i> 200	Fruit, <i>ill.</i> op. p. III,	268, 270, 273, 280
—Prescott discusses	654	Flats, 1st, 2nd, 3d (grades)	147	—Beverages from	11
—Trigg's recommendations	654	Flavor	210, 295, 307	—Description of	141, 275, 287
Filtration devices		—Cup comparisons	300	—Food use	11, 275, 624
—Aborn's filter <i>c.-pot</i>	621	—Deterioration	303	—Microscopy	287
—Baker's cloth	616	—Effect of grinds on	655	—Structure	288
—Beart's pneumatic, <i>ill.</i>	630, 638	—Effect of vacuum	302, 378	Fry & Co., Henry A.	437
—Blanke's cloth	618	—Loss during roasting	654	Fryer, <i>q.</i>	266
—Brain's vacuum, <i>ill.</i>	630, 638	—Loss in ground coffee	300	Fuels	
—Caseneuve's paper, <i>ill.</i>	583	Flavoring, Use in	658	—Coal	242
—Reversed Fr. drip	629	Fleury & Barker	599, 604	—Electricity	239, 242, 243, 389, 616
—de Mattei's patent	620	Flint, J. G.	430, 441	—Gas	239, 242
—Double glass	615, 631	Flint, W. K.	441	Fullard, William	608
—Evan's tin air-float	638	Flint, Wyman	441	Fulton Mills	434
—"Express"	618	Flint, W. & J. G.	441	Future contracts, N. Y.	363, 367
—French, early, <i>ill.</i>	583	Flint Bros. & Co.	436	Futures market, New York	357
—Gaudet's cloth	583, 629	Flint Co., J. G.	441	Fuzelier, <i>q.</i>	711
—Half-minute	612, 631	Flint, Evans & Co.	438		
—Italiana Sovereign	618	Floor brokers	367		
—Kings "Percolator"	619, 631	<i>Flora de las Antillas, q.</i>	4		
—Kin-Hee	615	Floridan	23, 24		
—Make-right	618, 631	Flower, botanical description of	271, 275		
—Minute	612	—Illustrations... op. p. III,	272, 273, 274, 275, 276, 281, 283, 284		
—Napier's vacuum, <i>ill.</i>	598	Flower, Henry	122	"G. E." chromium percolator	633
—Parker's pneumatic	638	Flugel & Popp	438, 439	Gabriel, Angel	11, 19
—Platow's vacuum glass, <i>ill.</i>	630, 638	Folger, Jr., J. A.	432, 441	Gaffney, Hugh	433
—Private Estates	617, 631	Folger, Sr., J. A.	422, 432	Gage, H. N.	440
—Raparlier's, <i>ill.</i>	583	Folger & Co., J. A.	377, 405, 423, 439, 441, 443	Gainsborough, Thomas	80
—Salazar's steam-pressure urn	620	Folger, Schilling & Co.	441, 443	Galen	7
—Tricolator	618, 620, 631	Folger's coffee advertisement, <i>ill.</i>	478, 480, 482	Gallagher, Ben	445
—Station type, <i>ill.</i>	636	Folkingham <i>c.-pot, ill.</i>	719, 725	Gallagher, Paul C.	446
—"Triumph"	629	Fontenelle	91, 95, 685	Gallagher, R. K.	446
—Tru-Bru	618, 631	Food and Drugs Act, U. S.	258, 350	Galland, Antoine, <i>q.</i>	8, 12, 17, 18, 27, 663
—Vanderweyde's "continuous"	598	Food and drugs inspection	367, 370	Galt, Herbert	619
—Victoria Arduino, La, 618, <i>ill.</i>	619	—Decision No. 82	369	Galuppi	676
—Wear's patent	619	Food and Grocery Chain Stores of America, Inc.	387	Gambetta	93
Finch, William, <i>q.</i>	33	Food use	537, 575, 623	Gandais, J. A.	585, 629
Fin-djans	27, 540, 576	Food value	306	Ganse, John H.	442
Findlay, J. A.	75	—U. S. Army	466	Gardell, Theodore	80
Findlay, Paul, <i>q.</i>	390	Footes, Samuel	81, 84	Gardens	
Fine Arts, <i>c.</i> in relation to	704, 732	Forbes, A. E.	432, 438; <i>q.</i> 589	—Botanical	
Fine Arts Coffee	466	Forbes, Chas. P.	438	—Amsterdam	2
Fine Arts Coffee Co., Inc.	466	Forbes, James H.	432, 438, 589	—Martinique (Jardin Desclieux)	5
Fines		Forbes, Robert M.	406, 408, 438	—Paris (Jardin des Plantes)	2, 149
—England	55	Forbes Tea & Coffee Co., James H.	438	—Experimental	
—Sweden	40	Force & Co., W. H.	418	—Camayenne (Fr. Guinea)	283
—Germany	43	Force & Co., W. S.	419	—Java	39
Fin-ion ( <i>see</i> Findjans)		Formaleoni, Vincenzo	23	—Pleasure (New York)	120
Finjans ( <i>see</i> Findjans)		Forrester, George R.	444	—Cherry	120
Pink & Nasse Co.	438	Forster, E. S.	444	—Contoit's	120
First		Foster, <i>q.</i>	266	—New York	120
—Advertisement	50	Foster, A. C.	415	—Ranelagh	120
—Newspaper	52	Foster, D. B.	409	—Sans Souci	120
—Authoritative treatise	23, 661	Francesconi, Floriono	23	—Vauxhall, <i>ill.</i>	119, 120
—Brazil cargo to U. S.	401, 411	Francis, Norman	427	—Pleasure (London)	76-79
—Boston	408	François, Damane	30	—Cuper's	78
—Houston	408	Frank, Dr. Marion G.	650	—Dog and Duck	78
—Comprehensive treatise in German	42	Frankel, E. M.	648	—Marylebone	78
—Description in print	22	Frankel, F. Hulton, <i>q.</i>	623	—Ranelagh	77, 78; <i>ill.</i> , 78
—Ground <i>c.</i> Package	403, 452	Franklin, Alfred, <i>q.</i>	3	—Vauxhall	77; <i>ill.</i> , 78
—Manuscript, <i>ill.</i>	660	Franklin, Benjamin	91, 95, 122, 399	—Tea (London)	77
—Mention by European	1	Franklin, Samuel	411	—Adam and Eve	79
—Printed mention	20, 21	Franklin, Walter	411	—Bagnigge Wells	79
—America	101	Franklin Coffee Co.	446	—Bayswater	79
—England	31; <i>ill.</i> 32, 34	Franklin Tea Warehouse	438, 472	—Canonbury House	79
—Europe	8	Franklin, David	606, 611	—Copenhagen House	79
—France	27	Fraser Manufacturing Co.	611	—Highbury Barn	78
—Printed treatise	663	"Fraunfelder" china drip <i>c.-pot.</i>	633	—Hornsey	79
—Sold publicly in London	51	Frederick the Great	41, 42	—Jews' Harp	79
—Written mention in Mass.	103	Frederick, William I.	41	—White Conduit House	79
Fischer, Benedickt	428, 433, 594	Freeman, W. G., <i>q.</i>	271	Garraway's	53, 73, 76, 79
Fischer, Emil	296	French Cameroon <i>c.</i>	208	Garrick, David	76, 77, 80, 84, 689, 697
Fischer, William H.	433	<i>French Color Prints of the XVIII Century, q.</i>	707	Garrick, Westphal & Co., S. B.	411
Fischer & Co., B.	433, 435	French Company of the Indies	5	Garrison, C. H.	444
Fischer & Lansing	435	French National Museum and Colonial Garden	284	Garthorne, George	719
Fischer & Lehmann	435	Freshness	373, 377, 378	Garway, Thomas ( <i>see</i> also Garraway's)	79
Fischer & Thurler	435	Freudenberg	297	Gas in roasted <i>c.</i>	304, 654
Fischer, Kirby & Brown	433, 435	Friele, Berent	386, 408, 409, 467, 493	<i>Gastronomy as a Fine Art, q.</i>	677
Fishbein, Dr. Morris, <i>q.</i>	318	Friele & Sons, B.	467	Gates, H.	441
Fishback, Frank S.	445	Frisbie & Stephens	442	Gates, John W.	449
Fishback Co.	445	<i>From Tree to Cup with Coffee, q.</i>	646	Gates & Co., A. B.	444
Fisher, George	433	Fromm, David E.	409	Gaudet	629
Fisher, Wm.	439			Gautier, Théophile	93, 98
Fisher Bros. Co.	244			<i>Gazette de France, q.</i>	4
Fitzpatrick, Austin C.	431			Ge, Edward	593
Fitzpatrick, Irving	431			Gehlert & Co., R. S.	444
Fitzpatrick & Case	435				
Fitzpatrick & Co., A. C.	431, 435				
Flake coffee	262, 657				
Flanders, Geo. W.	418, 426				

PAGE		PAGE		PAGE
430, 445	Geiger, Frank J.	607	Grading (Machinery) (cont'd)	PAGE
445	Geiger-Fishback Co.	359-361	—Squier's, <i>ill.</i>	
444, 445	Geiger-Tinney Co.	326, 327	—New York Exchange	
5	Gelabert, José Antonio		—Santos, <i>ill.</i>	
12, 660	Gemaleddin, Sheik	206	Gradings	
262	General Can Co.	222	—Arabia	
445	General Foods Co.	218	—Brazil	
443	General Grocery Co., Inc.	207	—Colombia	
165	General Outturn	213	—Ethiopia	
102	George III	224	—Guatemala	
718, 719	George V. c-pot, <i>ill.</i>	225	—Harar	
41, 471	Georgi, Theophilo	205	—India	
126	Gerard (French minister)	213	—Jamaica	
406, 408, 493	Gerhart, R. L.	224	—Mexico	
424	German Kosmos Line	215	—Mochas	
455	German Trading Co.	216	—Nicaragua	
1, 136, 275, 277	Germination	136	—Puerto Rico	
539, 709	Gérôme, Jean Léon		Grafting	
421	Ghirardelli, D.		Gragé (see Peaberry)	
441	Ghirardelli & Co., D.	68	<i>Grand concern of England explained</i>	
617	Giacomini, Luigi	234, 245	Grand Union Tea Co.	
77	Gibbon, Edward	425	Granda & Rawlins	
425	Gifford Co., G. M.	444	Granger & Co.	
429	Gilbert, Colgate	444	Granger & Hodge	
36	Gilbert, Gustav, <i>q.</i>	621	Grant, J. C. H.	
434	Gilbert & Co., Colgate	682	Grant, Ulysses S.	
281	Gillet, Frère		Granulating (see grinding)	
444	Gillett, A. B.		Granulators (see Grinding machines)	
372, 429	Gillies, E. J., <i>q.</i>	646, 672	Gray, Arthur, <i>q.</i>	
428, 429	Gillies, James W.	76	Gray, Thomas	
428, 429, 433	Gillies, Wright	386, 415, 435	Great American Tea Co.	
429, 435	Gillies & Bro., Wright	435, 467	Great Atlantic & Pacific Tea Co.	
429, 434, 435	Gillies & Co., Inc., E. J.	482	—Advertising	
429, 435	Gillies Coffee Co.	386	—Coffee sales	
386, 415	Gilman, George F.	386	—History	
127, 203	Girardots <i>c.</i>	385	—Premiums	
251	—In blends	615	—Store grinders, <i>ill.</i>	
634	Glass <i>c.</i> makers, <i>ill.</i>		Great Boom (see Booms)	
	Glass jars (see containers)	472	Great London Tea Co.	
	Glazing		<i>Greeks of the Present Day, About, q.</i>	
451	—Arbuckle's patent	567	Green, William	
568	—Italy	427	Green Coffee Association of New York	
436	Glines, J. T. & N.	362, 408	Green Coffee Assn. of San Francisco	
429, 454	Glohe Mills, Thomas Reid's	426	Green coffee marks, <i>ill.</i>	
431, 433, 434, 454		368	Green Coffee Assn. of New Orleans, Inc.	
565	Gloria, Café	426	Green Dragon <i>c.</i> urn, <i>ill.</i>	
418	Glover, Force & Co.	729, 731	Greene, Richard A.	
293	Glucose	608, 620	Greenwood, Paul	
418	Glynn, Martin J.	67	Gregory, <i>chk.</i>	
418	Glynn & Co., Martin J.	88	Grever & Bro.	
643	<i>Godley's Lady's Book, q.</i>	436	Grevy, Francois Paul Jules	
442	Godfrey & Sons Co.	685	Griffiths & Co., J.	
451	Goetzinger, M. E., <i>q.</i>	444	Griggs, B. G.	
379, 479	Golden Gate (brand)	440	Griggs, C. Milton	
	"Golden Key" china and aluminum	439	Griggs, Col. C. W.	
633	— <i>c.</i> -pot	440	Griggs, E. G.	
478	Golden Sun (brand)	440	Griggs, M. W.	
479	Golden Wedding (brand)	439	Griggs, Cooper & Co.	
479	Golden West (brand)	444	Grigor & Co., T. S.	
24, 675	Goldoni, Carlo		Grinding	
75, 77, 81, 83, 84	Goldsmith, Oliver		—Ethiopia	
718	Goldsmiths		—France	
5, 184	Gomez, Juan Antonio		—Household	
425	Good & Co., M. S.		—England	
308	<i>Good Housekeeping, q.</i>		—United States	
425	Goodman & Beer Co., Inc.		—Steel cut	
604	Gordon, Douglas		—Wholesale	
413, 417	Gordon, Fred P.	236, 250, 251, 252	Grinding machinery, <i>ill.</i>	
421	Gordon, G. O.	609-617	—Chronology	
439	Gordon, G. S.	598	—Burstone Mills	
593	Gordon, John	577	—Household, <i>ill.</i>	
439	Gordon Coffee & Spice Co.	575	—First	
413, 425	Gordon & Co., Fred P.	575; <i>ill.</i>	—Millstones	
421	Gordon & Co., Geo. O.		Grinding Machines	
585	Gordon & Co., John		—Household	
656, 730	Gorham Co.		—Book's	
621	Gorham Mfg. Co.		—Bronson's patent	
297	Gorter, <i>q.</i>		—Bruff's patent, <i>ill.</i>	
240, 601	Gothot, Ferd. Co.		—Clark's hand-mill	
449	Gould, George J.		—Colaux's patent	
411	Gouverneur, Nicholas		—Dearman's patent	
462-465	Government control, wartime.		—English, early, <i>ill.</i>	
	Government monopoly		—First English patent	
188, 343, 513	—Netherlands Indies		—First French patent	
417, 424, 425	Grace & Co., W. R.		—First U. S. patent, <i>ill.</i>	
361	Grade (N. Y. Exch.)		Grinding Machines	
360	—Certificate		—Household	
147	Graders (N. Y. Exch.), <i>ill.</i>		—Book's	
158	Grading		—Bronson's patent	
604	—Brazil		—Bruff's patent, <i>ill.</i>	
604	—Machinery		—Clark's hand-mill	
604	—McKinnon's		—Colaux's patent	
604	—Monitor		—Dearman's patent	
			—English, early, <i>ill.</i>	
			—First English patent	
			—First French patent	
			—First U. S. patent, <i>ill.</i>	
			Grinding Machines (Household)	
			(cont'd)	
			—French, early, <i>ill.</i>	
			—Gold	
			—Herbert's patent	
			—Jeweled, <i>ill.</i>	
			—Kenrich's mill, <i>ill.</i>	
			—Lacoux' combined roaster and grinder	
			—Moore's mill	
			—Morgan's glass-jar mill	
			—Parker's hand mill	
			—Pound, first	
			—Rittenhouse's hand mill	
			—Selden's hand mill	
			—Stowe's hand mill	
			—Strowbridge's box mill	
			—Turkish	
			—Combination	
			—Van Vliet's hand mill	
			—Webb's box mill	
			—Wilson's steel mill	
			—Retail	
			—Bauer Bros.	
			—Burns' grinding mill, <i>ill.</i>	
			—Cleveland Kleen-Kut, <i>ill.</i>	
			—Dell's store mill	
			—Duplex, <i>ill.</i>	
			—Enterprise	
			—Electric, <i>ill.</i>	
			—Hohart, <i>ill.</i>	
			—Holwick, <i>ill.</i>	
			—Morgan's patent	
			—Royal, <i>ill.</i>	
			—Troemner, <i>ill.</i>	
			—Universal, <i>ill.</i>	
			—Uno, <i>ill.</i>	
			—Wholesale	
			—Barhor mill	
			—Burns' granulator	
			— <i>ill.</i>	
			—with chaff removal	
			—Gump, <i>ill.</i>	
			—Huntley	
			—"Ideal" magnetic separator, <i>ill.</i>	
			—"Ideal" steel-cut mill	
			—Prentiss & Page	
			—Rapid, <i>ill.</i>	
			Grinds, <i>ill.</i>	
			—In relation to brewing	
			—Irregular (King's patent)	
			—Universal or all-purpose	
			—Various, usefulness of	
			Griswold, H. F.	
			Grocers' profits and costs	
			Grocery stores (see retail stores)	
			Groff & Co., Charles R.	
			Grohens, A. P.	
			Gross, March & Co.	
			Grossman, George A.	
			Grossman, William	
			Grossman Co., Wm.	
			Ground <i>c.</i>	
			—First package, U. S.	
			—Percentage sold in U. S.	
			—Price list (1862), <i>ill.</i>	
			—Under microscope	
			Gruner & Co.	
			Gruppe, Charles P.	
			Guadeloupe <i>c.</i>	
			Guardian, London	
			Guardiola, José	
			Guatemalas <i>c.</i>	
			Guilddhall Museum	
			Guillasse, Dr., <i>q.</i>	
			Gump Company, B. F.	
			Gutteridge, Mary and Robert	
			Guy, Francis	

H

439	H. P. Coffee Co.
417	Haas, Kalman
446	Haas, Baruch & Co.
417	Haas Bros.
147	Habitant
	Haciendas (see Plantations)
205	"Haciendas" (grade)
581, 629	Hadrot
444	Haehnlen Bros.

	PAGE		PAGE		PAGE
Haeussler, August	416	Haydon	80	Holmes, Francis	107
Haitis c.	128, 129, 179,	Hayes, John (and Mrs.)	440	Holmes, F. T.	404, 605, 606, 607
Hakimani	13	Hayward, George W.	444	Holstad, S.	440
Hakluyt Society	266	Hayward, Martin	430, 436	Holstad & Co., S.	440
Hall, G. M.	437	Hayward & Co.	436	<i>Home, q.</i>	683
Hall, Howard R.	622	Hazlitt, Carew W., <i>q.</i>	24, 25	Home Economics Laboratories,	
Hall, Robert (Rev.)	676	Hazlitt, William	676	Un. of Kansas	646
Hall & Co., Martin L.	436	Healthfulness of coffee	313, 320	Home-service merchants	383, 385
"Hall" china drip c.-pot	633	—Advertisement	474	—Coffee sales	384
Halsey, R. T. Haines, <i>q.</i>	728, 729	Heart, Effect on	307, 319	—Number of	384
Halstead, Charles	610	Hébert	91	—Premium display, <i>ill.</i>	384
Halstead, John P.	621	Hedging	357, 363	Homer	8
Haly Co., G. S.	425	Heekin, James	430, 439	Hondas c.	127, 203
Hamill, David B.	445	Heekin, James J.	439	Honduras c.	202
Hamill, Smith	445	Heekin, Robert E.	439	Honey in coffee	101, 642
Hamill & Co., S.	444, 445	Heekin & Co., James	439	Hoopes, B. F.	444
Hamilton, Alexander	126	Heekin Co.	439	Hoover, Herbert	463
Hamilton, Chas. H.	406, 408	Heekin Co., James	618	Hope, G. W.	617
Hamlin, Mary P.	126, 676	Heekin Spice Co.	439	Hope Mills	433
Hamor, W. A.	261, 466	Hekem	16	Hopman, John	149
Hamsley, M. F.	606	Helen of Troy	8	Horn, William L.	445
Hanauer, Herman	417	Hellick Co., Geo. F.	384	Horner, Jr., Maurice L.	437
Hanauer, Moses G.	417	Hellsten, <i>q.</i>	311	Horner & Co., Henry	437
Hanousek, <i>q.</i>	284	Henckel, James	581	Horter, John	442
Hancock, John M.	385, 493	Hendershot, Peter	444	Hotel Astor (brand)	478
<i>Handbuch der Physiologie, q.</i>	308	Henderson, D.	417	Hotels	
Handling		Henneman, Karel F.	604	—London	
—Hamburg, <i>ill.</i>	356	Henrion	581, 628	—Piccadilly	557
—New Orleans	353	Henry IV	55	—Savoy	557; <i>ill.</i> 558; 560
—New York	347	Hentz & Co., Henry	417	—Waldorf	558
—San Francisco	354; <i>ill.</i> 355	Herbert, Luke	593	—New York	
Handling charges		Herbert, Sir Thomas	35	—Ambassador	572
—Brazil	334	Herklotz, Corn & Co.	417	—Astor	572
—New York	349, 350, 351	Herbert, Sir Thomas	265, 266	—Astor House	571
Hanley, John	416	Herz, Geo. C.	608	—Ritz, <i>ill.</i>	572
Hanley & Co., Geo. F.	444	Hess, H. P.	444	—Waldorf-Astoria	572
Hanley & Kinsella	416	Hesser bag making machine, <i>ill.</i>	254	Houghton, <i>q.</i>	36
Hanley & Kinsella Coffee and		Hewitt, Jr., Robert C.	416	<i>Houghton's collection, q.</i>	49
Spice Co.	438	Hewitt, H. H.	443	Houri caff	267
Hanly, E. D.	439	Hewitt & Phyfe	416	Howell, James	36, 53
Harar c.	207	Hewlett & Co.	425	Howell, Son & Co., B. H.	415
Harari c.	169, 515	Hewlett Bros.	446	Howells, William Dean, <i>q.</i>	668, 686
Harazi c.	206	Heyman Process Corp.	657	Howland & Aspinwall	412
Hard, Anson Wales	416	Hickerson, Wm. H.	409	Hoyt & Co., W. M.	437
Hard & Rand	403, 413, 416, 421,	Hickerson Importing Co.	425	Huatusco c.	201, 202
Hardy, Charles O., <i>q.</i>	363	Hidey	144	Huber & Stendel	444
Hare, Dr. Hobart A., <i>q.</i>	319	Hiers Co., Chas. G.	466	Hudson, D. D.	443
Hargreaves, C. F.	603	Higgins & Co., Geo. W.	436	Hudson, Thomas	80
Harland, Marion	613, 629	Hildreth, A. G.	416	Hudson & Co., H. C.	443
Harler, C. R., <i>q.</i>	317	Hill, Dwinell & Co.	436	Hudson Mills	433
Harnit & Hewitt Co.	442	Hill & Thornley	437	Huestis & Hamilton	444
<i>Harper's Weekly, q.</i>	12	Hillis Plantation Co.	435	Huggins-Young Co.	446
Harriman, E. H.	449	Hills, A. H.	441	Hugo, Victor	93
Harrington, Elizabeth	732	Hills, Reuben W.	436, 441	Hullers	146-147
Harrington, James	56	Hills Bros.	377, 441	—Abbey's	584
Harris, Benj.	112	—Advertisements, <i>ill.</i>	481, 489	—Adams & Ditson	585
Harris, Samuel L.	427	Hinchman & Howard	444	—American, <i>ill.</i>	600
Harris, Wm. B.	427, 648	Hinkle, Henry	436	—Bronson's	585
Harrison, D. Y.	430, 439, 589	Hinz, F. W.	439	—Costa Rica, <i>ill.</i>	173
Harrison, W. H.	406, 430, 439	Hinz & Sons Co., F. W.	439	—Engelberg, <i>ill.</i>	600, 603
Harrison & Co., W. H.	439	Hippocrates	7, 8	—First U. S. patent	583
Harrison & Wilson	439	Hirsch, <i>q.</i>	311	—Haiti, <i>ill.</i>	179
Hart & Howell	413	Hiscox, E. W.	406	—Krupp, <i>ill.</i>	600
Hartford, Geo. H.	386	<i>Historia Vitae et Mortis, q.</i>	35, 663	—Lidgerwood	598
Hartford Steam Coffee & Spice		<i>Historic Silver of the Colonies</i>	726	—Lyman's	585
Mills	444	<i>History and Antiquities of the</i>		—Mason	604
Hartwich, <i>q.</i>	281	City of Boston, <i>q.</i>	104, 112	—"Monjola" water power, <i>ill.</i>	152
Harvesting	163	<i>History and Reminiscences of</i>		—"Niagara," <i>ill.</i>	593
—Arabia	171	Lower Wall Street, <i>q.</i>	403, 414	—O'Krassa, <i>ill.</i>	604
—Costa Rica, <i>ill.</i>	172	<i>History of Am. Manufactures,</i>		—Panter's	580
—Mexico	187	<i>q.</i>	101, 111	—Smout's	147; <i>ill.</i> 605
—Netherlands Indies	188	<i>History of Literature, q.</i>	681	Hulling	146, 158
—Uganda	196	Hobart Electric Mfg. Co.	619	—Brazil, early method, <i>ill.</i>	151, 152
Harvey, Gideon, <i>q.</i>	54	Hobart Mfg. Co.	621	Hulls, beverage from	537, 624
Harvey, William	36	Hobson-Jobson, <i>q.</i>	265	Hulman, H.	444
Haslett Warehouse Co.	423	Hoch, <i>q.</i>	311, 312	<i>Humboldtiana c.</i>	284
Hassey, Cornelius	427	Hockhoffer, R.	422	Hume ( <i>pseud.</i> of Voltaire)	676
Hatch & Jenks	444	Hodgdon, Dr. Daniel R., <i>q.</i>	317	Humphreys, <i>chk.</i>	117
Hatfield, <i>c.-pots, ill.</i>	726	Hodges, Alderman	49, 51	Humphreys, H. M.	417
Hatton, Edward, <i>q.</i>	51	Hodhat, Kadh, <i>q.</i>	546	Hungerford, G. S.	610
Haulenbeek, Jr., John W.	433	Hoffman, Daniel H.	440	Hungerford, G. W.	610, 611
Haulenbeek, Sr., John W.	433	Hoffmann & Sons Co.	442	Hungerford Co.	611
Haulenbeek, Peter	428, 429, 433, 435	Hogarth, William	75, 76, 80, 696, 705-707, 711	Hunt, Leigh	670, 676; <i>q.</i> 682
Haulenbeek & Co., John W.	433	Holbrook, E. F.	466	Hunt, Mathew	438, 591
Haulenbeek & Mitchell	435	Holbrook Grocery Co.	446	Huntley Mfg. Co.	242, 404, 604, 606, 607
Haulenbeek Roasting & Milling		Holland, Dr. A. L., <i>q.</i>	317	Huntoon & Towner	437
Co.	435	Holland Coffee Co.	433, 435	Huid, Jacob	726
Hauxhurst, Sidney	442	Hollingworth, H. L., <i>q.</i>	311, 312, 657	Hurricanes, damage by	510
Havemeyer, Henry O.	442, 450, 452	—Caffeine investigations	308, 309, 648	Husking ( <i>see</i> Hulling)	
Havemeyers, The	452	Holman, Roger P.	409, 446	Husks, beverage from	624
Hawaiian c.	129, 210; <i>ill.</i> 280	Holman & Co.	439	Husted, Ferguson & Titus	417
Hawkins, Thomas	440			Husted, Wetmore & Titus	417
Hawkins & Thornton	440			Hutchins, John	112, 113
Haworth & Dewhurst	443				

# INDEX

805

	PAGE
Hutchinson, Gov. ....	105
Hutchinson, Jonathan, <i>q.</i> ....	314
Hutchinson, Woods, <i>q.</i> ....	308, 318
Hutb & Co. ....	425
Huygen, John ( <i>see</i> Van Linschooten)	
Hybrids ....	277, 283
Hyde, John ....	118
Hyde, E. J. ....	433, 594
Hydrolysis ....	651, 652

## I

Ibn Sina ( <i>see</i> Avicenna)	
Ibrik (boiler) .. 27, 539, 551, 575, 625	
iced coffee .. 477, 497	
Iglehart, Richard S. ....	622
<i>Illustrated History of English Plate, q.</i> .. 719	
Imbusch, J. F. W. ....	442
Importing Ports	
—Amsterdam .. 355	
—Antwerp .. 355	
—Hamburg .. 355	
—Havre .. 355	
—New Orleans .. 353	
—New York .. 347	
—Rotterdam .. 355	
—San Francisco .. 354	
Imports	
—Aden (for re-export) .. 512	
—Argentina .. 523	
—Australia .. 523	
—Baltimore .. 419	
—Belgium .. 522	
—Chile .. 523	
—Denmark .. 522	
—Finland .. 522	
—France .. 28, 29, 522	
—Germany .. 522	
—Italy .. 522	
—Malaya, British .. 514	
—Mauritius .. 517	
—Netherlands .. 522	
—Early .. 39	
—New Orleans .. 419	
—New York .. 419	
—New Zealand .. 523	
—Nigeria .. 517	
—Norway .. 522	
—Philippines .. 514	
—Portugal .. 522	
—San Francisco .. 354, 419, 522	
—Spain .. 522	
—Sweden .. 522	
—Union of So. Africa .. 522	
—U. S. S. R. ....	522
—United States .. 531-534	
—Brazil <i>c.</i> .. 411, 526, 533	
—Central American <i>c.</i> .. 533	
—Charts and tables .. 511, 529, 530, 532, 533	
—Colombian <i>c.</i> .. 533	
—Early .. 420	
—First in Am. vessels .. 400	
—Value .. 530, 531, 533	
—World imports of green <i>c.</i> .. 505	
Impotence, coffee and .. 19	
Independent Grocers Alliance .. 386	
"Indian" coffee .. 525	
Indias <i>c.</i> .. 128, 206	
<i>Indigena c.</i> (Maragogipe) .. 200	
<i>Influence des cafés sur les moeurs politiques, q.</i> .. 97	
<i>Influence of Alcohol and Other Drugs on Fatigue, q.</i> .. 311	
Infusion	
—Cold .. 638	
—Defined .. 627, 628	
—Origin .. 626	
—Time of .. 655	
Infusion devices	
—Bezzara's stem .. 618	
—Biggin .. 555; <i>ill.</i> , 556; 584, 629; <i>ill.</i> .. 630	
—Dakin's cloth-bag .. 592	
—Denobe's .. 581, 628	
—Donmartin's flannel sack .. 580, 627	
—Etruscan .. 613; <i>ill.</i> , 630	
—First French .. 580	
—Individual .. 621	
—Fustian bag .. 579, 626	

	PAGE
Infusion devices ( <i>cont'd</i> )	
—Halstead's china-lined metal .. 610	
—Ideale, <i>ill.</i> .. 618, 619	
—L'Aine's Diligence .. 580	
—Rapid .. 620	
—Old Dominion .. 642	
Insomnia caused by coffee .. 308, 318	
Inspection ( <i>See also</i> Sampling)	
—Colombia, <i>ill.</i> .. 167; 340	
—New York .. 347	
Instituto de Café do Estado de São Paulo .. 158, 159, 323, 334, 491, 493	
<i>Intelligencer, q.</i> .. 55, 471	
International Coffee Congress .. 404	
Introduction, beverage	
—Aleppo .. 15	
—American colonies .. 103	
—Austria .. 45	
—Cairo .. 13	
—Constantinople .. 15	
—Damascus .. 15	
—England .. 31-38	
—Europe .. 21	
—France .. 27-30	
—Germany .. 41	
—Italy .. 21, 22	
—Mecca .. 13	
—Medina .. 13	
—Netherlands .. 39-40	
—New York .. 101, 111-120	
—North America .. 101-109	
—Paris .. 29, 87	
—First sold publicly .. 88	
—Philadelphia .. 121	
—Sweden .. 40	
—Venice .. 23	
—Vienna .. 45-48	
—Western Europe .. 21-26	
Ireland, Augustus .. 416	
Ireland, Sam .. 711	
Ireland, Inc., B. C. ....	425
<i>Irene, q.</i> .. 684	
Irish <i>c.</i> -pot, <i>ill.</i> .. 720, 727	
Irwin, Will, <i>q.</i> .. 686	
Israel, Leon .. 417	
Israel & Bros., Leon .. 417, 425	
Ittel .. 603	

## J

Jackson, Charles James, <i>q.</i> .. 719	
Jackson, S. ....	421
Jackson & Co. ....	435
Jacob .. 37, 38	
Jacquand .. 709	
Jaecle, <i>q.</i> .. 299	
Jamaica <i>c.</i> .. 129, 205	
James, James .. 123	
Jamison, Robert .. 453	
Jamison, Wm. Arbuckle .. 452, 453	
Janney, Jr. & Co., B. S. ....	437
Janszen Co. ....	439
Jardin Desclieux .. 5	
Jardin des Plantes .. 2, 149	
Jardin, Edélestan, <i>q.</i> .. 2, 10, 12, 23, 27, 28, 266, 587, 625, 685	
Jarvie, James N. ....	416, 452, 453
Jause .. 47	
Java <i>c.</i> .. 127, 129, 208	
—Manipulated .. 370	
—U. S. regulations .. 369, 405	
Jefferson, Thomas .. 126	
Jeffreys, Judge .. 690	
Jenkins & Bro., T. C. ....	443
Jenkins & Co., T. W. ....	443
Jennings, Constantine .. 57, 81	
Jerals, Ed .. 439	
Jewel Tea Co. ....	385
Jewett, Milo P. ....	441
Jewett & Sherman Co. ....	441, 442
Jezveh .. 540	
Johannes, E. C. ....	409
Jobson, Cirque .. 37	
Johns, Benjamin .. 108	
Johnson, George J. ....	425
Johnson, James D. ....	429
Johnson, Samuel .. 75, 76, 77, 84, 676, 681, 687-689	
Johnson & Co., Theo. F. ....	444
Johnston, H. L. ....	615, 619

	PAGE
Johnston, Wm. ....	436
Johnston & Co., E. ....	421, 488
Johnston, Gordon & Co. ....	421
Joint Coffee Trade Publicity Committee .. 477, 489-491, 658	
—Booklets .. 490, 649	
—Brewing .. 649	
—Coffee Club .. 490	
—Recipes .. 649	
—Scientific research .. 489, 490	
Jones, Dorothy .. 103, 104, 399	
Jones, J. F. ....	443
Jones, M. P. ....	421, 441
Jones, W. T. ....	406, 432, 440
Jones, Webster .. 408, 421, 441	
Jones Bros. ....	435
Jones Bros. Tea Co. ....	425
Jones-Paddock-Castle Bros. ....	423
Jones Thierhach Co. ....	422, 441
Jonson, Ben .. 56	
Joseph, <i>chk.</i> .. 89	
Joteyko, <i>q.</i> .. 311	
Jourdain, John, <i>q.</i> .. 266	
<i>Journal Am. Med. Assn., q.</i> .. 318, 319	
<i>Jour. Biol. Chem., q.</i> .. 294, 295	
<i>Journal d'Antoine Galland, q.</i> .. 266	
<i>Journal of Assoc. of Official Agricultural Chemists, q.</i> .. 282	
<i>Journal of the Savants, q.</i> .. 10	
<i>Journal of the Gen. Assembly of the Colony of New York, q.</i> .. 113	
<i>Journey through England</i> .. 71, 74	
Jugs, coffee, <i>ill.</i> .. 720, 727	

## K

Kaf .. 267	
Kafa .. 267	
Kafe .. 267	
Kafeo .. 267	
Kaffa .. 267	
Kaffa coffee .. 169	
Kaffe .. 267	
Kaffee .. 265, 267	
Kaffee Hag Corp. ....	405
Kaffee-klatsch .. 41, 471, 566	
Kaffee-sieder .. 46, 48	
Kaffia .. 267	
Kafva .. 267	
Kahl, E. A. ....	417
Kahoueb .. 267	
Kahua .. 267	
Kahué .. 267	
Kahvah .. 265	
Kahvé .. 267	
Kahvedjibachi .. 16, 18	
Kahvehji .. 548	
Kahvi .. 267	
Kahwa .. 267	
Kahwab (coffee-room) .. 539	
Kahwe .. 41	
Kaimaki .. 568	
Kair Bey .. 13	
Kaldi .. 6, 10	
Kaltenbach, George .. 412, 457	
Kanan Devan <i>c.</i> .. 128, 206	
Kant, Immanuel .. 682	
Kapi .. 267	
Kapi-bija .. 267	
Kapi-kottai .. 267	
Kapri-vittulu .. 267	
Karavan Coffee Co. ....	442
Karker, M. H. ....	385
Kasper, Adam J. ....	406
Kasper Co., A. J. ....	438
Kato, Sartori .. 404, 465	
Kato Coffee Co. ....	465
Kaufee .. 267	
Kava .. 267	
Kavah .. 266	
Kavé .. 267	
Kaveh kanes .. 13, 16	
Kavveggi .. 18	
Kawa .. 267	
Keable, B. B., <i>q.</i> .. 316	
Keats, John .. 670	
Keen, William .. 116	
Keenan, Jos. H. ....	609
Keen's Chop House .. 434	
Kéhi .. 267	
Kell, Raymond W. ....	622
Kellogg Co. ....	622



PAGE		PAGE		PAGE	
Kelly, George	436	La Roque, Jean, q.	1, 11, 27, 28,	Lewis, Teacle Wallace	416
Kelly, H. D.	618	29, 30, 87, 133, 142, 576,		Lewis & Co., T. W.	416
Kemmler, Norman	426	624, 625, 662, 663, 684		Libby Glass Mfg. Co.	622
Kendrick, F. G.	442	Labaree & Co., J. H.	416, 417	Liberian c.	208
Kenny, C. D.	443	Labeling, laws affecting	258, 378, 379	<i>Liberica</i> c.	198, 279
Kenrich, Archibald	584	Labor		—Botanical description	278
<i>Kentucky Warbler, The, q.</i>	684	—Brazil	153	—Dutch Guiana	179
Kenya c.	128, 129, 182, 207	—Colombia	164	—Liberia	182
Kerr, Mary Alice	452	—Guatemala	179	—Madagascar	183
"Kewaskum" aluminum drip c-pot	633	—Mexico	187	—Malaya	187
Khawah ( <i>see</i> Kahwah)		—Salvador	194	—Netherlands Indies	188
Kia-fey	267	Labroy	284	Liberty Boys	116
Kickleburys on the Rhine, q.	682	Lacoux, Francois René	585	Licenses	
Kidde, Frank	414	<i>Ladies Home Journal, q.</i>	472	—Boston	
Kilgour & Taylor	439	<i>Ladies Home Magazine, q.</i>	643	—Coffee house	104
Killian, Dr. John A., q.	318	Lahcy, B.	416	—First, Dorothy Jones	103
Kimball, O. G.	403, 414, 455, 456	Laird, Dr. Donald, q.	318, 319	—England	55
King, John E.	466, 618, 648	Lait, Café au	563, 571, 575, 626, 641	—Coffee house	55
King Coffee Co., John E.	444	Lally, Albert V., q.	690	—Fee	55
King Coffee Products Corp.	466	Lamb, Charles, q.	670	—First royal warrant	55
King of American breakfast table	103	Lamb, Jos. F.	622	—France, first	30
King of perfumes	565	Lamb, Wm. A.	621	—Germany	42, 43
<i>Kingdom's Intelligence, q.</i>	470, 471	Lambert, Joseph	404, 606, 615	—United States	
Kinsella, W. J.	432	Lambert Food & Machinery Co.	615	—First (1670)	399
Kipfel	47	Lambert Machine Co.	617	—Wartime	370
Kirby, James H.	416	Lamboray c.	281	Lidgerwood, John	598
Kirby & Halstead	416	<i>Lancet, q.</i>	315	Lidgerwood, Wm. Van V.	598, 603
Kirby, Halstead & Chapin	416	Landers, Frary & Clark	404, 610,	Liebreich, q.	311
Kirkland, A.	416, 435	615, 617, 622,	631	Lievre, Frick & Co.	441
Kirkland, W. J.	416	Lang & Co.	443	<i>Life of Addison, q.</i>	681
Kirkland & von Sacks	416	Langfeld	312	<i>Life of Johnson, q.</i>	686, 687
Kirkland Bros.	416	Lantern-shaped coffee pot, <i>ill.</i>	719, 721	Lightfoot, Alexander	116, 117
Kirsch & Mausser	240	Larco, Nicholas	422	Lincoln, Abraham	732
Kisher	172	Larousse, q.	87	Lindo & Co., Donald	425
—Method of preparing	537, 540	Lascelles & Co., A. S.	417	Linn, A. R. & W. F.	444
Kitchen, James	126	Last-bag notice, New York	348	Lins, Albuquerque	333, 459
<i>Kitchen Directory and American Housewife, q.</i>	642	Lastreto, L. F.	422	<i>Linschooten's Travels</i>	31, 39
"Kitchenraft" aluminum drip c-pot	633	Lastreto & Co.	421	Lion (brand)	450, 452
Kitchenet (brand)	466	Laughlin & Co., J. W.	443	Lion's head (Button's c. house)	695
Klug, Wm. L.	622	Laurens	583, 629	Lippincott, Jesse H.	443
Knickbocker & Cooke	435	Laurent, Emil	281	Liqueur and c.	563, 565
Knickbocker Mills Co.	431	<i>Laurentii c.</i>	281	Liquid coffee	258, 261
Knight, Eberian & Co.	442	<i>Laurentii gillet c.</i>	279	Lispensard, Leonard	411
Knowles, Cloyes & Co.	437	<i>Laurina c.</i>	277	Literature of coffee	660-703
Knowlsey, Thomas John	593	Lauzaune	603	Literature, Influence of c. on.	676
Koch, q.	311	Lauzaune, Etablissements	585, 613	—England	77
Koehrmann, J. W.	442	Law-suits, U. S.	404, 406, 450	—Paris	91, 93
Koenig & Co., J. Henry	439	Lawrence, George W.	419, 463, 465	Littledo, L., q.	670
Koffee	265	Lawrence & Co., George W.	425	<i>Lives of Eminent Men, q.</i>	36
Koffie	265, 267	Lawrence & Van Zandt	411	<i>Lives of the Lord Chancellors, q.</i>	690
Kohwah	8	Lawton, Frederick, q.	676	<i>Lives of the Poets</i>	690
Kolschitzky, Franz George	44, 45, 46, 708	Lawton, William	605, 619	Livierato, B. A.	414
—Introduces c. to Vienna	45	Lazear, Jesse	443	Livierato, Gregory B.	414
—Portrait	46	Le Candiot	89	Livierato Bros.	414
—Statue	46, 47; <i>ill.</i> 715; 717	Le Gantois, <i>chk.</i>	89	Livierato-Kidde Co.	414
Kona c.	210, 422	le Lacheur, Capt. William	173	Livingston, Wm. J.	622
Kondor coffee tablet	262	Le Morgan Coffee Co.	443	Livingstons; The	411
Kooman, G. W.	617	Le Page, Jules	620	<i>Livre Commode</i>	471
Kopf, J. L.	454, 608, 609	Leaf-blight ( <i>see</i> Diseases)		Lloyd, De Courcy	425
Kophe	267	Leaves, <i>ill.</i>	op. p. III, 275	Lloyd, Edward	81
Kopi	267	—Beverage from	271, 624	Lloyd, John C.	416
Koppi	267	—Botanical description	271	Lloyd & Co., John C.	416
<i>Koran, q.</i>	11, 16	Leclerc	93	Loading	329-331
Korbin & Co., Wm. L.	425	Lee, H. H.	444	—Buenaventura, <i>ill.</i>	340
Kraepelin, a.	311, 312	Lee & Cady	444	—India, South, <i>ill.</i>	344, 345
Krag-Reynolds Co.	437	Lee & Murbach	437	—Santos	329-331
Krause, Richard F.	621, 622	Lee Mercantile Co., H. D.	439	Lockwood, Dr., q.	308
Kreiser, Alexander W.	440	Lefèvre	93	Lockyer, Captain	116
Kreissel, Phillip	465	Legal café	267	Loeven & Co., E.	441
Kroberger, Charles	436	Legends, Some early	9-12	Logan, John A., q.	387
Kroneberger & Co., C. H.	443	Leggett, Francis H.	417	London fires	57, 59, 72, 79
Krout, J. M.	439	Leggett & Co., Francis H.	404, 416, 417, 427	London Café Co.	557
Krupp A. G. Grusonwerk, Fried.	604	Leme, Raymundo Alves dos Santos		London Club (brand)	431
Kuchelmeister, F.	616	Prado	151	<i>London Pharmaceutical Journal, q.</i>	285
Kündig, Fritz	621	Lemierre	91	<i>London Pleasure Gardens of the 18th Century, The, q.</i>	78
Kuhlemer, Fred J.	617	Lemmon & Sons	442	Long, William and Mary	52
Kuhlke, George F.	417	Lemonade venders	23, 91, 99, 469, 554	Longberry Harar	207
Kunhardt, Henry	417	Lendrick, Carl	621	Longe, W. Harry	484
Kunhardt & Co.	417	Lensing, J. H.	599	Longevity, Effect of c. on	315
Kunz Co., F. W.	425	Leo XIII, Pope, q.	669	Longhi, Alessandro	706
Kuprili, Grand Vizier	17, 45	Leonard & Co., T. E.	426	Longhi, Pietro	24, 675
		Leopold, Emperor	45	Lopez, Pedro	184
		Lepper, q.	282	Lopez Pumarejo, Miguel	486
		Lester, George C.	616	Lopez & Co., J. M.	425
		L'Estrange	55	Lorimore Bros.	444
		<i>Lettre sur l'Origine et le Progres du Café, q.</i>	8	Lorraine, Prince of	45, 46
		Levering & Co., E.	443	Lott & Low	411
		Levering Coffee Co.	443	Loudon, Howard C.	429
		Levy, Florence N., q.	728	Loudon, J. Carlyle	429
		Levy & Co., Inc., S. A.	425	Loudon & Johnson	429, 435
		Lewis, Charles	406, 439, 615	Loudon & Son	429
				Loudon & Stellwag	429

# INDEX

807

	PAGE		PAGE
Louis XIII .....	87	Manners and Customs ( <i>con't</i> )	
Louis XIV .....	2, 29, 87, 88	—England .....	71-76
Louis XV .....	4, 88, 91, 683, 718	—Ethiopia .....	537
Louisiana Coffee Mills .....	441	—France .....	563
Love, I. N., <i>q.</i> .....	319	—Germany .....	566
Low, Seth .....	407	—Italy .....	23, 24, 568
Low & Co., Adolphe .....	422	—London .....	55-57, 69
Lowell, Ebenezer .....	399	—Mexico .....	570
Lower Wall St. Bus. Men's Assn. ....	407, 413	—Morocco, <i>ill.</i> .....	538
Lowry Coffee Co., W. G. ....	444	—Netherlands .....	569
Ludlow & Goold .....	437; <i>ill.</i> 490	—New Orleans .....	571
Ludolphus, <i>q.</i> .....	411	—North America .....	570-573
Luiz, Washington .....	1	—Norway .....	569
Lyman, John Chester .....	491	—Oriental, early .....	13, 16, 18, 19
Lyons, A. Neil, <i>q.</i> .....	585	—Palestine, <i>ill.</i> .....	553
Lyons & Co., Ltd., <i>J.</i> .....	682	—Paraguay .....	574
—Window display, <i>ill.</i> .....	235	—Persia .....	93, 95, 97
Lytton, Lord .....	396	—Portugal .....	18
	98	—Portuguese E. Africa .....	570
		—Portuguese E. Africa .....	539
		—Saxony .....	567
		—Somaliland .....	537
		—South America .....	573, 574
		—Sweden .....	569
		—Thuringia .....	567
		—Turkey .....	16, 23, 33, 35, 549
		—Uganda .....	537
		—Union of S. Africa .....	539
		—United States .....	570-573
		—Uruguay .....	574
		—Vienna .....	555
		Manning, E. B. ....	598
		Manning, Bowman & Co. ....	617, 631
		Manning Bowman chromium perc-	
		lator .....	633
		Mansion Brand Instant Coffee ..	466
		Manthey-Zorn Laboratories .....	620
		<i>Mantsaka c., ill.</i> .....	279
		Manuring ( <i>see</i> Fertilizing)	
		Many, Daniel .....	443
		Maps	
		—Brazil .....	199
		—Colombia .....	337
		—South America .....	199
		—World, coffee .....	516
		Maracaibo <i>c.</i> .....	128, 204
		—In blends .....	252
		Maragogipe <i>c.</i> .....	185, 200, 278
		—India .....	194
		Marat .....	91
		Marchand & Hignette .....	603
		Marcuson, Henry .....	621
		M'Ardell (mezzotinter) .....	80
		Marden & Folger .....	441, 443
		Marden & Myrick .....	441
		Margins .....	357
		Marie Antoinette .....	93
		Marilhat .....	708
		Markets	
		—Europe .....	355
		Market names ( <i>see also</i> Complete	
		Reference Table) .....	129
		Marking coffee bags	
		—Colombia .....	339, 340
		—United States .....	352
		Marlborough, Earl of .....	105
		Marmontel .....	95
		Marshall & Willey .....	426
		Martelley, Lewis .....	584, 629
		Martin .....	603
		<i>Martinique, Histoire de la, q.</i> ..	4
		<i>Martinique, La, q.</i> .....	4
		Martinson, Joseph .....	436
		Martinson's advertising, <i>ill.</i> ..	487, 488, 495
		Marvin, Walter S. ....	621
		Mason, L. F. ....	415
		Mason, Marcus .....	173, 594, 604
		Mason & Co., Marcus .....	594, 604
		Mason & Thompson .....	411
		Mason, Ehrman & Co. ....	443
		Mass. Inst. of Technology .....	314
		—Scientific research .....	648
		"Massilon" aluminum drip <i>c.-pot</i> ..	633
		Massieu, Abbé Guillaume, <i>q.</i> ..	10, 663
		Matagalpa <i>c.</i> .....	203
		Matheson, S. ....	417
		Matheson, Jr. & Co., S. ....	417
		Mattari <i>c.</i> .....	206
		Maumenet, <i>q.</i> .....	667
		Mauran, C. S. ....	437
		<i>Mauritiana c.</i> .....	283
		—Caffeine content .....	284
		Maury-Cole Co. ....	446
		Maximilian Frederick, Elector, <i>q.</i> ..	43
		Maxon, Harry R. ....	608
		Maxwell House Products Co. ....	445
		—Advertising copy, <i>ill.</i> .....	488, 496
		—Brand .....	379, 479
		—Roasting plant .....	261
		Mayer Bros. & Co. ....	403, 417
		Mayo, Henry .....	435
		Mazagan, Café .....	537, 564
		Mazerolles, S. ....	709
		Meacock, James .....	587
		Meade, Leland S. ....	620
		Measure-Rite Co. ....	621
		Mecke & Co. ....	425
		Medellins <i>c.</i> .....	127, 203
		—In blends .....	252
		<i>Medical Journal and Record, q.</i> ..	319
		Medical opinions .....	314-320
		<i>Medical Times, q.</i> .....	308
		Medicinal properties of <i>c.</i> .....	8, 22, 23, 35, 37, 53, 54
		Medicine .....	316
		—Coffee first used as .....	469, 623
		—Café au lait used as .....	626
		Medina, José .....	488
		Medina Co., J. A. ....	425
		<i>Meditations, q.</i> .....	627
		Medium roast .....	210
		Meehan, P. C. ....	412
		Meehan & Co., P. C. ....	412, 413, 425
		Meehan & Schramm .....	412
		Meidinger, <i>q.</i> .....	685
		Meilhat .....	711
		Meisner, Leonhard Ferdinand ..	42, 663
		Meith, Hugo .....	709
		Melangé, Café .....	555
		Melaye, S. ....	668
		Mellon Inst. of Industrial Re-	
		search .....	262, 646, 657
		<i>Memoirs, d'Arvieux, q.</i> .....	18
		<i>Memoirs, Diderot</i> .....	95
		<i>Memoirs, Sherman, q.</i> .....	682
		Menado <i>c.</i> .....	210
		Mendonca, Castro .....	151
		Mengai .....	624
		<i>Menosperma c.</i> .....	277
		Menown, Hugh .....	591
		Menown, H. & J. ....	438
		Menown & Gregory .....	591
		<i>Men's Answer to Women's Petiti-</i>	
		<i>tion, The</i> .....	67
		<i>Menschlichen Genussmittel, Die, q.</i> ..	284
		Mental and Motor Efficiency ..	308
		—Effect of caffeine on .....	308, 311, 313
		—Effect of tea on .....	312
		Menzel, Adolph .....	709
		Merchants Coffee Co. ....	443
		Merchants Coffee Co. of N. O.,	
		Ltd. ....	441
		Merchants Exchange, New York ..	119
		Merck & Co. ....	405
		<i>Mercur de France, q.</i> .....	4
		Meridas <i>c.</i> .....	128, 204
		Merritt & Ronaldson .....	434
		Merwin & Co., Geo. A. ....	434
		Mery, C. D. ....	668
		Mesocarp, <i>ill.</i> .....	288
		Messape .....	153
		Messenger & Co., Thomas H. ..	416
		Metal Ware Corp. ....	621
		Metchnikoff, <i>q.</i> .....	315
		Metropolitan Mills .....	429
		Metropolitan Museum of Art,	
		N. Y. ....	539, 638, 639, 709, 716, 718, 724
		Mexicans <i>c.</i> .....	128, 129; <i>ill.</i> 201
		—In blends .....	252
		Meyer, Albert W. ....	621, 622
		Meyer, Fred W. ....	438
		Meyer, Robert .....	408
		Meyerheim, Paul .....	709
		M'Ginley, Joseph .....	427
		M'Gregor, Coll .....	411
		Michaud, I. F. and L. G., <i>q.</i> ..	4
		Michelet, <i>q.</i> .....	95
		Microscopy of coffee .....	286-291
		—Analysis, value .....	291
		<i>Microscopy of Vegetable Foods, q.</i> ..	288
		Midland Spice Co. ....	444
		Milde .....	709
		Milds ( <i>see also</i> Characteristics)	
		127, 161, 198, 201	
		Milk in coffee .....	35, 54, 570
		—Boiled .....	641

## M

M. J. B. (brand) .....	479
M. J. B. Co. ....	441
Macaulay, Thomas B., <i>q.</i> .....	71
Macbeth, Geo. D. ....	622
Macbeth-Evans Glass Co. ....	622
Machinery ( <i>see also</i> plantation	
machinery)	
—Colombia .....	166
—Costa Rica .....	173
—English export to U. S. ....	585
—Evolution of .....	575-622
—German .....	599-601
Mackay .....	71, 74, 75
MacKaye, Payson .....	454
Mackey, C. A. ....	425
Mackey, Chandler W. ....	419
Mackey, William D. ....	413, 418, 426
Mackey & Co. ....	413
Mackey & Small .....	413, 416
Mackintosh, Sir James .....	676
<i>Macrocarpa c.</i> .....	283
MacVeagh & Co., Franklin .....	437
Madagascar <i>c.</i> .....	282
<i>Madagascariensis c.</i> .....	283
Maddux, H. Clay .....	416, 426
Magic Cup (brand) .....	466
Maguire, Charles .....	415
Maguire, Joseph .....	433
Maguire & Gillespie .....	444
Mahomet ( <i>see also</i> Mohammed)	
Mahood, E. B. ....	443
Mahood, Samuel .....	430, 443
Mahood, W. James .....	443
Mail-order houses .....	383
Maine Historical Society .....	103
Maine & Eckerenkotter .....	441
Mairebert, <i>q.</i> .....	686
Maitland, Coppel & Co. ....	417
Maitland, Phelps & Co. ....	417
Makara, <i>chk.</i> .....	89
Malabars <i>c.</i> .....	206
Malaria, Effect of <i>c.</i> on .....	316
Maliban .....	88
Mallet, J. W., <i>q.</i> .....	315
Man, Alexander .....	55, 57, 84
Mandehling <i>c.</i> .....	209
Manet, Edouard .....	99, 100
Manipulated Java .....	370
Manizales <i>c.</i> .....	127, 203
<i>Manner of Making Coffee, Tea and</i>	
<i>Chocolate</i> .....	471
Manners & Customs .....	537-574
—Africa .....	537
—Africa, Portuguese E. ....	539
—Algeria .....	537; <i>ill.</i> 538, 545
—Arabia .....	539-546
—In the open .....	540
—Argentina .....	573
—Asia .....	539-554
—Austria .....	554
—Brazil .....	573, 574
—Bulgaria, <i>ill.</i> .....	561
—Chile .....	574
—Colombia .....	574
—Constantinople .....	16, 18, 19
—Damascus .....	551
—Egypt .....	537, 539
—In barber shops, <i>ill.</i> .....	540

	PAGE		PAGE		PAGE
Milk in coffee ( <i>con'td</i> )		Muhlberg, R.	599	National C. Roasters Traffic and	
—Effect of	313	Muller, Frederick H.	620	Pure Food Assn.	406
—First used by Nieuhoff	626	Munden, Admiral	679	National Coffee Trade Council,	
—Hot	555, 557, 563	Murdock, Charles A.	442	408, 409, 493	
Millar & Co., E. B.	437, 438	Murdock & Co., C. A.	444	—Educational campaign	493
Miller, Chas. A.	416	Murdock Mfg. Co., C. A.	442	National Coffee Week	407, 408, 477, 491
Miller, Harry	416	Murfer, Henry	95	National Congress of Coffee Grow-	
Miller, James	674	Murray, Sir James, <i>q.</i>	265	ers, Colombia	166, 167
Miller, Theodore	621	Murray, James H.	431	National Federation of Coffee	
Miller, Watts	416	Murray, Robert	411	Growers of Colombia	162, 163, 166, 339, 481, 486
Miller & Co., H. H.	425	<i>Murta c.</i>	277	—Publicity	487
Miller & Walbridge	416	Music, Coffee in	675, 711-717	—Research	650
Mills, coffee ( <i>see grinding ma-</i>		Music in coffee houses	547, 549	National Recovery Act	409
chines)		Mustapha, Kara	45, 47	National Retail Tea and Coffee	
Milling ( <i>see also Cleaning</i> )	237	Mustard in coffee	626	Merchants' Assn.	385
Milton, John	669	Mustonen, Henry T.	622	<i>National Review, q.</i>	69
Minas <i>c.</i>	199	Mysore <i>c.</i>	128, 206	Natural method of preparation,	
—U. S. regulations	369			142, 143, 164	
Minas Coffee Institute	159			<i>Nature of the Drink Kahuhi, The,</i>	
Miner, W. H.	441			<i>q.</i>	8
Minford, Thomas	415			<i>Nature, quality and most excellent</i>	
Minford & Co., L. W.	415			<i>virtues of coffee, The</i>	
Minford, Lueder & Co.	413, 415			( <i>hroadside</i> ), <i>ill.</i>	66
Minford, Thompson & Co.	414, 415			Navarro, Francisco Xavier	5
Minott, Samuel	726, 729			Nave-McCord Mfg. Co.	444
Minute (brand)	466			Neidlinger & Schmidt	435
Minute, Café à la	641			Nelliampathy <i>c.</i>	207
Mississippi Shipping Co.	352			Nelson, Charles	617
Mitchell, George	413			Nepenthe	8
Mitchell, William L.	413			Nerve food, <i>c.</i> as a	315
Mitchell Bros.	413, 425			"Nesco" enamel drip <i>c.</i> -pot	633
Mixing	241			Netherlands East India Co.	39, 187, 513, 523, 526
Mixing machinery	237, 241; <i>ill.</i>			—Bill of sale, <i>ill.</i>	524
—Burns	597			Netherlands Indies <i>c.</i>	127
—Van Gülpen	599			Neutral ( <i>see</i> Flavors)	
Mixtures, Strange coffee	53			Nevers, George J.	415
<i>Molat With the Crimson Stains,</i>				Nevison, J.	591
<i>The, q.</i>	683			<i>New and curious coffee-house, etc.,</i>	
Mocengio	23			<i>The</i>	41, 471
Mocha <i>c.</i>	128, 129, 171, 206; <i>ill.</i>			New Caledonia <i>c.</i>	208
—In blends	252			<i>New Discoveries, etc., q.</i>	9
—U. S. regulations	369, 405			<i>New English Dictionary, q.</i>	265
Mocha longberry <i>c.</i>	169			New Hebrides <i>c.</i>	208
Mocha of Arussi <i>c.</i>	170			New Jersey Historical Society	108
<i>Modern Italian Poets, q.</i>	668			New Orleans Coffee Co.	440, 441
<i>Modern Packaging</i>	377			<i>New View of London, q.</i>	51
Mogelings, Carl	616			New York	
<i>Mogeneti c.</i>	284			— <i>American</i>	674
Mohammed	11, 15, 16			—Coffee and Sugar Exchange ( <i>see</i>	
Mohammed IV	29, 45, 47, 87			Exchange)	
Mohedano, José Antonio	5, 341			— <i>Daily Advertiser, q.</i>	400, 471, 472
Moisture content	293, 305			—Dock Co.	347; <i>ill.</i> 348, 349, 460
Moka <i>c.</i>	171, 192			— <i>Evening World</i>	673
Mokaska Mfg. Co.	444			— <i>Gazette, q.</i>	114
Mokkae <i>c.</i>	278			—Historical Society	407
Molke	5, 149			— <i>Journal, q.</i>	111
Molmenti, Pompeo, <i>q.</i>	23, 24			— <i>Medical Journal and Medical</i>	
Monarch (brand)	375, 379			<i>Record, q.</i>	314
Moneuse, Elie	601			— <i>Packet</i>	400
Monin, Sieur, <i>q.</i>	626			— <i>Times</i>	555
Monitor machines	604			— <i>Tribune</i>	672
Monkey coffee	275			<i>New York City Directory</i>	729
Monroe, James	109			New York docks (1828, 1850), <i>ill.</i>	
Montague, <i>q.</i>	671			398, 401, 402	
Montesquieu	97			Newbold, William	416
Moore, Alexander Duncan	583			Newell	594
Moore, C. M.	415			Newhall, H. B.	436
Moore, C. T.	444			Newmark, H.	445
Moore & Co., Geo. A.	422			Newmark, Maurice H.	445
Moréas, Jean	98			Newmark & Co., H.	445
Morewood, T. C.	606			Newstadt, Emil	599, 613
Morey Mercantile Co., C. S.	444, 446			Nihlo, William	117, 120
Morgan, Charles	611, 620			Nicaragua <i>c.</i>	128, 129, 202
Morgan, Edward H.	611			Nicholson, David	438
Morize	583, 629			Niebuhr, Karstens	18
Morkha <i>c.</i>	171			Nielsen, T. S. B.	417, 450
Morley, W. T.	408			Nieuhoff	626
Morosini, Gianfrancesco, <i>q.</i>	22			Niles, G. M., <i>q.</i>	307
Morrison, S. B.	433			Nilgiri <i>c.</i>	206
Morrison, Wm. J.	434			Nolte Brokerage Co.	425
Mortar and pestle	575; <i>ill.</i> 576, 577, 579, 624			Nordlinger, Henry	417
Morton, Robert	65			Nordlinger & Co., Henry	417
Mosely, Dr. Benjamin, <i>q.</i>	35			Norris, G. W.	406, 460, 461
Mosso, Ugolino, <i>q.</i>	311			North, Roger, <i>q.</i>	68, 690
<i>Most excellent virtues of the mul-</i>				Norton, Edward	377, 404
<i>berry called coffee</i>	30			Norton, Weyl & Beven	417
Mother (grade)	147			Nortz & Co.	425
Motion pictures	481, 487, 491, 493			Norwine, Floyd E.	406, 408
Mott & Williams	427			Norwine Coffee Co.	439
Mottant, A.	605, 613			Nurseries	136
Muddiman	55			—Colombia, <i>ill.</i>	135; 163
Mudiford	54				

## Mc

## N

# INDEX

809

Nutrio Mfg. Co. .... 437  
Nutt, Jr., F. T. .... 463

## O

Oakford & Fahnestock ..... 446  
Oaxaca c. .... 201  
Oberholtzer, Ellis Paxson, q. .... 121  
O'Brien, A. F. .... 426  
O'Brien, E. H. .... 424, 486  
O'Brien, Jonas P. .... 418  
O'Brien, Joseph A. .... 417, 426  
Oceana ..... 56  
O'Connor, James ..... 409  
O'Donohue, Charles A. .... 119  
O'Donohue, John ..... 416, 433  
O'Donohue, John B. .... 119, 433  
O'Donohue, Joseph J. .... 416  
O'Donohue, Peter ..... 416, 433  
O'Donohue & Sons, John ..... 403  
O'Donohue & Sons, Joseph J. .... 413, 416  
O'Donohue & Stewart ..... 433  
O'Donohue Coffee Co. .... 433  
O'Donohue's Sons, John. .... 404, 416, 433  
Of the Excellent Qualities, etc., q. .... 627  
Ogden & Co., George ..... 437  
Oglo, Frank J. .... 426  
Ohio Coffee & Spice Co. .... 444  
Ohio Valley Coffee Corp. .... 446  
Oil in coffee. .... 293, 294, 377  
O'Kassa, Don Roberto. .... 147, 604  
O'Kassa, R. F. E. .... 604  
Olavarria, J. D. .... 404  
Old Dutch Mills ..... 436  
Old Ground Coffee Works. .... 426  
Old Reliable (brand) ..... 496  
Old Reserve (brand) ..... 478  
Older & Co., B. J. .... 425  
Oldys, William, q. .... 49  
Olearius, Adam, q. .... 18, 41  
Olendorf, Case & Gillespie. .... 413  
Omar, Sheik ..... 6, 9, 12, 537  
Operas  
—Coffee and Cupid ..... 717  
—Le Café du Roi ..... 711  
Opposition (see also Controversies)  
—Commercial ..... 61  
—England ..... 61  
—Medical  
—Cairo ..... 15  
—Germany ..... 42  
—Marseilles ..... 28  
—Mecca ..... 13  
—Political  
—Constantinople ..... 525  
—England ..... 525  
—Germany ..... 42, 43  
—London ..... 65, 525  
—Religious  
—Cairo ..... 15  
—Constantinople ..... 16  
—Mecca ..... 13  
—Sweden ..... 40  
—Venice ..... 25  
Orange juice and peel in c. .... 102  
Ordinaries (see Taverns)  
O'Reilly, Count, q. .... 193  
Organon salutaris, q. .... 53  
Oriental Trip, q. .... 41  
Origin of c. .... 1, 7, 9-12, 661  
Orizaba c. .... 201, 202  
Ortega & Emigh, Inc. .... 425  
Osborn, Lewis A. .... 403, 431, 452  
Osborn's Celebrated Prepared Java, .... 403, 431, 452  
Osborne, Oliver T., q. .... 320  
Oseretzowsky, q. .... 312  
O'Shaughnessy, John W. .... 416  
O'Shaughnessy & Co., John W. .... 416  
O'Shaughnessy & Sorley ..... 416  
Ostrander, Loomis & Co. .... 444  
O'Sullivan, Eugene ..... 415  
O'Sullivan, James ..... 415  
O'Sullivan & Co., Eugene ..... 415  
Otis, James ..... 106, 107  
Otis, McAllister & Co. .... 425  
Otto, Carl Alexander ..... 605  
Over the Black Coffee, q. .... 646, 672  
Over-production ..... 404, 447  
Overton, John B. .... 415  
Ovington, q. .... 266

Oxford Coffee Club ..... 37  
Oxygen in roasted c. .... 304

## P

Pacific Mail Co. .... 424  
Package coffees  
—Advantages ..... 477  
—Advertising ..... 477  
—Early (U. S.) ..... 431  
—European, ill. .... 491  
—First ..... 427, 452  
—France ..... 562  
—Great Britain ..... 556  
—Wholesale ..... 371  
—Percentage of in U. S. .... 373, 388  
Packaging ..... 256-258  
—Bulk ..... 257-258  
Packaging machinery, ill. .... 254, 255; 256; ill. 257, 258; 374  
—Smyser ..... 452  
—Vacuum ..... 256, 257; ill. 259, 262  
Packard & James ..... 429  
Page, Chas. E. .... 621, 622  
Page, Thomas ..... 598  
Painter, John (see Paynter)  
Palaces, coffee (see Coffee houses)  
Palembang c. .... 209  
Palgrave, q. .... 541  
Palmer, David ..... 416  
Palmer & Co., H. H. .... 416  
Palmer, Harvey H. .... 416  
Palmer, Warner & Co. .... 444  
Paludanus, Bernard Ten Broeke, q. .... 31, 37, 39, 266  
Pamphlets (see Broad-sides)  
Panama-Pacific Exposition ..... 486  
Panamas c. .... 203  
Pan-American Congress ..... 404  
Panics  
—Cable-break ..... 456  
—Cook's, Jay ..... 455  
—U. S. .... 403, 447  
Panter, William ..... 580  
Paper bags (see containers)  
Paranas c. .... 200  
Paranaguas c. .... 198  
Parchment ..... 142, 146, 157, 165  
Parenchyma, ill. .... 289  
Parent & Co., J. A. .... 444  
Parini, Guiseppe, q. .... 668  
Park, Fellowes & Co. .... 444  
Park & Tilford ..... 427, 434  
Parke & Co., L. H. .... 437  
Parker, Charles ..... 585, 593  
Parker, Chas. B. .... 621  
Parker, Edmund ..... 585, 594  
Parker, Gilman L. .... 436  
Parker, John ..... 594  
Parker & Dixon ..... 439  
Parker & Harrison ..... 439  
Parker Co., Charles ..... 585  
Parkinson, John ..... 37, 663  
Parrott & Co. .... 425  
Parry (Welsh barber) ..... 80, 702  
Parry, William, q. .... 33, 34  
Parson ..... 676  
Pascal ..... 29, 88, 579  
Paschius, George, q. .... 9  
Patterson, Robert W., q. .... 102  
Paulista Institute for the Permanent Defense of Coffee ..... 158  
Pauly, John Peter ..... 621  
Pavoni, Desiderio ..... 618  
Pawinski, q. .... 311  
Paxton, Wm. A. .... 445  
Paxton & Gallagher Co. .... 445  
Paynter, Jonathan ..... 49  
Peaberry ..... 142, 147  
Peal, Geo. H. .... 621  
Pearce, F. E. .... 446  
Pearson, George ..... 443  
Pearson, Peter ..... 599, 604  
Peck, Edwin H. .... 413  
Peck, Walter J. .... 413  
Peck, E. H. & W. J. .... 413, 425  
Peck & Co., Edwin H. .... 413, 416  
Peck & Kellum, Benj. .... 444  
Peck, Stowe & Wilcox Co. .... 610  
Peddling  
—Constantinople ..... 17; ill. 548  
—Florence ..... 554

Peddling (cont'd) PAGE

—Italy ..... 23, 25  
—Paris ..... 88, 89, 91, 93  
—Vienna ..... 47  
Pedrocchi, Antonio ..... 25, 716, 718  
Peeling (see Hulling)  
Pellas, S. F. .... 425  
Pemberton, John ..... 124  
Penn, John ..... 123  
Penn, Letitia ..... 124  
Penn, William. .... 101, 111, 121, 124, 399  
Pennsylvania Gazette, q. .... 122, 123  
Pennsylvania Journal ..... 123  
Penny Magazine, q. .... 637  
Penny universities ..... 69  
Peonage (see Labor)  
Pepion, Gordon B. .... 444  
Pepion, John ..... 444  
Pepys, Samuel, q. .... 55, 71, 674, 681  
Peradeniya experimental station. .... 173  
"Porcelier" porcelain percolator. .... 633  
Percolation ..... 650  
—Defined ..... 628  
—N.C.R.A. recommendations ..... 650  
—Prescott discusses ..... 654  
—Trigg discusses ..... 650  
Percolators  
—Acker's Mo-Kof-Fee ..... 613  
—Testing-table ..... 613  
—Two cylinder ..... 617, 631  
—Andrew's pumping ..... 631  
—Bohemian ..... 620  
—Bowman's valve-type ..... 598  
—Bruning's vacuum jacket ..... 620  
—Cafetiere Sene ..... 629  
—Carlsbad ..... 620  
—Chamberlain's automatic ..... 620  
—De Belloy's. .... 581; ill. 582, 584, 627  
—De Santais' hydrostatic ..... 587  
—Durant's, ill. .... 582; 585, 629  
—Electric ..... 621, 622  
—First French patent ..... 629  
—Galt ..... 619, 631  
—Gandais', ill. .... 582; 585, 629  
—German (plug in spout), ill. .... 641  
—Glass ..... 622  
—Glass "balloons" ..... 585  
—Gorham's electric ..... 621  
—Grandin & Crepeaux's, ill. .... 582  
—Hadrot's "filter" ..... 581  
—Half-minute ..... 612, 631  
—Hutchinson's, ill. .... 630  
—Jones's, ill. .... 630, 638  
—Kellum automatic urn ..... 618  
—Kin-Hee ..... 631  
—Klug's electric ..... 622  
—Laurens' ..... 583, 629  
—Le Brun's, ill. .... 630, 643  
—Marion Harland ..... 613, 629  
—Mo-Kof-Fee (Acker's) ..... 613  
—Modern, ill. .... 632  
—Morize's reversible ..... 583, 629  
—Nason's fluid-joint ..... 598  
—Phylax ..... 619, 631  
—Platow's vacuum ..... 629, 638  
—Potsdam, ill. .... 630, 643  
—Preterre's vacuum ..... 593  
—Rabauts reversed ..... 629  
—Raparlier's glass, ill. .... 583, 598  
—Rumford's. .... 581, 582; ill. 583; 627; ill. 630  
—Savage's patent ..... 617  
—Smart's patent ..... 620  
—Star ..... 613  
—Sternau's patent ..... 617  
—Universal ..... 615  
—Vanderweyde's patent ..... 598  
—Vardy's vacuum urn ..... 585  
—Vienna, ill. .... 630  
—Warner's patent ..... 618  
Percolator, The, q. .... 451  
Perfect cup of coffee ..... 655  
Pericarp, ill. .... 288  
Perieri c. .... 283  
Pernambucos c. .... 200  
Persecutiou (see Opposition)  
Persian Letters, q. .... 97  
Perus c. .... 205  
Pests (see Diseases)  
Peter Collection ..... 577  
Peters, J., q. .... 399  
Petit, q. .... 8  
Petty, Sir William ..... 56  
Pharm. Zentralhalle, q. .... 294, 297

PAGE		PAGE		PAGE
	<i>Pharmaceutice Rationalis, q.</i> . . . . . 54		Plantation preparation ( <i>cont'd</i> )	
	Pharmacology of coffee . . . . . 306-320		—Brazil . . . . . 151-152	
	Phelps, Jr., Edward A. . . . . 429, 435		Plantations	
	Phelps, William Lyon, <i>q.</i> . . . . . 320		—Angola . . . . . 170	
	Phelps, Krag & Co. . . . . 444		—Cazengo . . . . . 170	
	<i>Philadelphia; a history of the city</i>		—Brazil (fazendas)	
	<i>and its people, q.</i> . . . . . 121		—Barboza, <i>ill.</i> . . . . . 157	
	Philadelphia Centennial Exposition . . . . . 571		—Boa Vista, <i>ill.</i> . . . . . 157	
	Philidor . . . . . 93, 95		—Guatopara, <i>ill.</i> . . . . . 156	
	Philipp, John . . . . . 709		—Ribeirão Preto, <i>ill.</i> . . . . . 148, 155	
	Philippi, Peter . . . . . 709, 711		—São Paulo, <i>ill.</i> . . . . . 132, 136, 148	
	Philippine Islands <i>c.</i> . . . . . 129, 210		—Santa Ursula . . . . . 149	
	Philips, Ambrose . . . . . 76		—Cochin-China, <i>ill.</i> . . . . . 175	
	Phipps, Sir William . . . . . 107		—Colombia, <i>ill.</i> . . . . . 162	
	Phipps & Co., J. L. . . . . 412, 417, 421		—First . . . . . 161	
	Phoenix, John . . . . . 417		—La Amalia, <i>ill.</i> . . . . . 160, 164	
	Phoenix & Co., J. W. . . . . 417		—Number of . . . . . 162	
	Phoenix Electrical Heating Co. . . . . 616		—Cincinnati, <i>ill.</i> . . . . . 339	
	Phyfe, James W. . . . . 416		—Cuba, <i>ill.</i> . . . . . 174	
	Phyfe & Co., Jas. W. . . . . 414, 416		—Eritrea (number of) . . . . . 174	
	Physical effects of <i>c.</i> . . . . . 308		—French Indo-China . . . . . 175	
	<i>Physique Sacree, ou Histoire</i>		—Haiti . . . . . 179	
	<i>Naturelle de la Bible, q.</i> . . . . . 12		—Hawaii, <i>ill.</i> . . . . . 178	
	"Picked Haciendas" . . . . . 205		—Number of . . . . . 515	
	Picking . . . . . 142		—India	
	—Arabia . . . . . 171		—Cannon's Baloor . . . . . 194	
	—Brazil, <i>ill.</i> . . . . . 154, 155		—Hoskahn . . . . . 194	
	—Colombia, <i>ill.</i> . . . . . 164		—Mylemoney . . . . . 194	
	—Cuba, <i>ill.</i> . . . . . 174		—Sumpigay Kahn . . . . . 194	
	—Ecuador . . . . . 174		—Ubban, <i>ill.</i> . . . . . 195	
	—Jamaica, <i>ill.</i> . . . . . 180		—Yield per acre . . . . . 194	
	—Mexico, <i>ill.</i> . . . . . 183		—Mexico, <i>ill.</i> . . . . . 183	
	—Puerto Rico . . . . . 193		—La Esperanza, <i>ill.</i> . . . . . 184	
	Picksley, Joseph D. . . . . 413, 417, 418		—Orduña . . . . . 184	
	Pictures		—Netherlands Indies	
	—Afternoon in the court gardens,		—Bifara Tjina . . . . . 187	
	Munich . . . . . 709		—Bokit Gompang, <i>ill.</i> . . . . . 187	
	—Button's coffee house, <i>ill.</i> . . . . . 711		—Cornelis . . . . . 187	
	—Café en Asie Mineure . . . . . 708		—Kampong Melajoe . . . . . 187	
	—Café sur un route de Syrie . . . . . 708		—Palmerah . . . . . 187	
	—Café Turc . . . . . 708		—Soedimara . . . . . 187	
	—Coffee comes to the aid of the		—Soekaboemi . . . . . 187	
	Muse . . . . . 709; <i>ill.</i> 711		—Nicaragua . . . . . 189	
	—Coffee house at Cairo . . . . . 709; <i>ill.</i> 710		—Philippine Islands . . . . . 191	
	—Dutch coffee house of 1650, <i>ill.</i> 704		—Salvador . . . . . 194	
	—First coffee house in Vienna, <i>ill.</i> 708		—Las Tres Puertas, <i>ill.</i> . . . . . 193	
	—Four times of the day, <i>ill.</i> 705, 707		—Sumatra, <i>ill.</i> . . . . . 282	
	—French coffee house . . . . . 711		—Venezuela (haciendas)	
	—Kaffeebesuch . . . . . 709; <i>ill.</i> 711		—Longa-Espana, <i>ill.</i> . . . . . 196	
	—Lion's head at, Button's . . . . . 711		—Number of . . . . . 197	
	—Mad dog in a coffee house . . . . . 711; <i>ill.</i> 712		Planting ( <i>see also</i> Propagation)	
	—Mme. de Pompadour, <i>ill.</i> . . . . . 706, 708		—Colombia . . . . . 163	
	—Mme. Du Barry at Versailles, <i>ill.</i> . . . . . 706, 709		—Planting at stake . . . . . 135	
	—Manager Classen and his family . . . . . 709		—Planting distances . . . . . 136, 153	
	—Napoleon and the curé . . . . . 711; <i>ill.</i> 713		—Abyssinia . . . . . 169	
	—Old woman with coffee cup . . . . . 709		<i>Les Plants Tropicales de Grande</i>	
	—Oriental coffee house . . . . . 709		<i>Culture, q.</i> . . . . . 270	
	—Parisian boulevard café . . . . . 709		<i>Plants of Egypt, q.</i> . . . . . 22	
	—Pastor Rautenberg and his		Platow, Moritz . . . . . 585, 629	
	family . . . . . 709		Plays	
	—Petit déjeuner, <i>ill.</i> . . . . . 706, 708		—Autocrat of the Coffee Stall, <i>The</i> . . . . . 676	
	—Rake's progress, <i>ill.</i> . . . . . 705, 706		—Beaux' Stratagem, <i>q.</i> . . . . . 705	
	—Saturday Afternoon at the		—Bold Stroke for a Wife, <i>A., q.</i> . . . . . 674	
	Coffee Table . . . . . 709		—Bottega di Caffè, <i>La</i> . . . . . 675	
	—Slaughter's coffee house . . . . . 711		—Café, ou l'Écossaise, <i>Le</i> . . . . . 675, 676	
	—Sweets shop of Josty in Berlin . . . . . 709		—Café, <i>Le</i> . . . . . 674	
	—Tom's coffee house . . . . . 711		—Café di Campagna, <i>Il</i> . . . . . 676	
	—Tom King's coffee house, <i>ill.</i> . . . . . 705, 707		—Caffetiéra da Spirito, <i>La</i> . . . . . 676	
	—Tontine coffee house . . . . . 709		—Coffee House, <i>The</i> . . . . . 674	
	—Washington's official welcome to		—Coffee House; or, Fair Fugitive,	
	New York, <i>ill.</i> . . . . . 711		<i>The, q.</i> . . . . . 676	
	Pieper Co., O. R. . . . . 442		—Coffee-House Politician, <i>The, q.</i> . . . . . 674	
	Pierce, Jr., O. W. . . . . 445		—Foire St. Germain, <i>La, q.</i> . . . . . 674	
	Pierce, Sr., Oliver Webster . . . . . 430, 445		—Hamilton, <i>q., ill.</i> . . . . . 676	
	Pierce Co., O. W. . . . . 444, 445		—Persian Wife, <i>The, q.</i> . . . . . 675	
	Pioneer Mills . . . . . 444		—Socrates . . . . . 676	
	Piron . . . . . 91		—Tarugo's Wiles; or, the Coffee	
	Pizarro, Mgr. . . . . 151		House, <i>q.</i> . . . . . 674	
	Place, E. B. . . . . 417		Pleasure gardens ( <i>see</i> Gardens)	
	Place, J. K. . . . . 417		—Pletzer, <i>q.</i> . . . . . 311	
	Plantation machinery . . . . . 585, 594, 604		—Pluma Oaxaca <i>c.</i> . . . . . 201, 202	
	Plantation machines		—Plumly, O. B. . . . . 415	
	—Guardiola . . . . . 603		—Pocoke, Edward, <i>q.</i> . . . . . 8, 35	
	—Krupp . . . . . 604		Pocumtuck Val. Mem. Ass'n . . . . . 106	
	—McKinnon . . . . . 585, 595		<i>Poemata Didascalia</i> . . . . . 663	
	—Marcus Mason . . . . . 604		Poems	
	—Monitor . . . . . 604		—A mon Café . . . . . 668	
	—O'Krassa . . . . . 604		—Bouquet Blanc et le Bouquet	
	—Squier . . . . . 594, 603		Noir, <i>Le</i> . . . . . 668	
	Plantation preparation . . . . . 136		—Café, <i>Le</i> (anon.) . . . . . 668	
	—Arabia . . . . . 133		—Café, <i>Le</i> , Berchoux . . . . . 668	
			—Café, <i>Il</i> . . . . . 668	
			—Cap and Bells, <i>q.</i> . . . . . 670	
			—Carmen Caffaeum, <i>q.</i> . . . . . 663	
			Poems ( <i>cont'd</i> )	
			—City Mouse and Country Mouse,	
			<i>q.</i> . . . . . 671	
			—Coffee, <i>q.</i> . . . . . 664, 672	
			—Coffee and Crumpets, <i>q.</i> . . . . . 670	
			—Coffee Companionship, <i>q.</i> . . . . . 663	
			—Coffee Slips, <i>The, q.</i> . . . . . 670	
			—Comus, <i>q.</i> . . . . . 669	
			—Divine Coffee, <i>q.</i> . . . . . 667	
			—Elogé du Café . . . . . 668	
			—Frugality, <i>q.</i> . . . . . 669	
			—Gilbert K. Chesterton Rises to	
			the Toast of Coffee, <i>q.</i> . . . . . 672	
			—Giorno, <i>Il, q.</i> . . . . . 668	
			—Grandeur de Dieu dans les	
			Merveilles de la Nature, <i>La</i> . . . . . 668	
			—Grounds for Complaint, <i>q.</i> . . . . . 673	
			—In Praise of Coffee, <i>q.</i> . . . . . 662	
			—Like His Mother Used to Make,	
			<i>q.</i> . . . . . 671	
			—Lines on Coffee . . . . . 668	
			—Ode to Coffee, <i>q.</i> . . . . . 672	
			—Pity for Poor Africans, <i>q.</i> . . . . . 669	
			—Plantes, <i>Les, q.</i> . . . . . 667	
			—Rape of the Lock, <i>q.</i> . . . . . 669	
			—Songs of Brittany . . . . . 667	
			—Three Reigns of Nature, <i>q.</i> . . . . . 667	
			—To the Coffee House, <i>q.</i> . . . . . 669	
			—To the Mighty Monarch, King	
			Kawhee, <i>q.</i> . . . . . 671	
			—What Every Wife Knows, <i>q.</i> . . . . . 673	
			Poetry, coffee in . . . . . 662	
			Poffenberger, Jr., A. T., <i>q.</i> . . . . . 657	
			Polhemus, Edw. . . . . 422	
			Polished coffee, rulings (U. S.) . . . . . 369	
			Polishing . . . . . 146, 147	
			—Brazil . . . . . 158	
			Polishing machinery . . . . . 146	
			—American, <i>ill.</i> . . . . . 600	
			—O'Krassa, <i>ill.</i> . . . . . 604	
			—Smout's . . . . . 147, 604	
			Political liberty; England's won in	
			coffee houses . . . . . 70	
			Politics, coffee and . . . . . 55, 62	
			Polli, Pietro . . . . . 678	
			Ponfold, Schuyler & Co. . . . . 417	
			Poore, G. W., <i>q.</i> . . . . . 639	
			Pope, Alexander . . . . . 75, 76, 669	
			—Life of, <i>q.</i> . . . . . 669, 696	
			Popularity of <i>c.</i> in U. S. . . . . 571	
			Portable <i>c.</i> -making devices	
			—Arabian . . . . . 538	
			—French . . . . . 471, 578	
			—Household stove . . . . . 578	
			Portable grinding machines . . . . . 638	
			Portal, Antoine, <i>q.</i> . . . . . 54	
			Porter, David (Capt.) . . . . . 108	
			Porter, Horace, Gen., <i>q.</i> . . . . . 682	
			Porter, Kirk E. . . . . 622	
			Porter & Co., W. J. . . . . 416	
			Ports, river	
			—Colombia . . . . . 335	
			Ports, shipping . . . . . 127-129	
			—Arabia . . . . . 511	
			—Brazil . . . . . 323-325, 503	
			—Colombia . . . . . 336; <i>ill.</i> 337	
			—Continental . . . . . 521	
			—Hamburg, <i>ill.</i> . . . . . 356	
			—Java . . . . . 209	
			—Santos . . . . . 325, 503	
			—Sumatra . . . . . 210	
			—Venezuela . . . . . 340, 341	
			( <i>see also</i> Complete Reference	
			Table)	
			Postulant . . . . . 605	
			Postum Co. . . . . 445	
			Pot and Kettle, <i>The, q.</i> . . . . . 690	
			Poth, A. C. . . . . 415	
			Potter, Ellis M. . . . . 434, 606	
			Potter Coffee Co. . . . . 433	
			Potter-Parlin Co. . . . . 242, 439, 605, 606	
			Potter-Parlin Spice Mills . . . . . 434	
			Potter, Sloan, O'Donohue Co. . . . . 434	
			Poursine & Co., P. . . . . 421	
			Poursini & Co., R. . . . . 440	
			Powder, coffee . . . . . 576	
			Powdered. ( <i>see</i> Grinds)	
			Poydras Street Dock . . . . . 353	
			Practical Therapeutics, <i>q.</i> . . . . . 319	
			Prado, Paulo da Silva . . . . . 460, 461	
			<i>Prædium Rusticum</i> . . . . . 663	
			Pratt, A. H. . . . . 437	
			Premium distribution	
			—Retail . . . . . 384, 385	





	PAGE		PAGE		PAGE
Research, scientific ( <i>cont'd</i> )		Roasters ( <i>cont'd</i> )		Roasting Mach's (Retail) ( <i>cont'd</i> )	
—Joint C. Trade Publicity Com.	489, 490	—Cleveland	442	—Franklin's electric	616
—Mass. Inst. of Technology	648	—Detroit	444	—Lambert's 50-pound	615
—Mellon Institute	646	—Duluth	439	—Lester's electric	616
—N.C.R.A.	408	—Kansas City	439	—Moegling's electric	616
—Prescott ( <i>see</i> under Prescott)		—Louisville	440	—Prim's cylinder improvement	607
—Trigg ( <i>see</i> under Trigg)		—Milwaukee	441, 442	—Probat, <i>ill.</i>	391
—University of Kansas	646	—New Orleans	440	—Royal, <i>ill.</i>	389, 607, 615
Restaurants ( <i>see also</i> Hotels, Coffee Houses, etc.)		—New York	434	—Seymour's electric	617
—Denmark, <i>ill.</i>	561	—Number of	446	—St. Louis, Jr.	617
—London	557-60	—Philadelphia	436	—"Simplex," <i>ill.</i>	390
—A.B.C., <i>ill.</i>	556; 557, 559	—Pittsburgh	443	—Talbutt's electric	616
—Brit. Tea Table Assn.	558	—Portland	443	—Uno, <i>ill.</i>	390, 616, 617
—Buszard's cake house	559	—St. Louis	438	—Sample	
—Café Royal	558	—St. Paul	439	—Burns, <i>ill.</i>	238, 598
—Corner Houses, Lyons	559	—San Francisco	441	—Improved	613
—Express Dairy Co.	559	—Toledo	442	—Swing-gate	616
—Gatti's	577; <i>ill.</i> 559	—United States	371	—Tilting	618
—Groom's <i>ill.</i>	557	—First wholesale	411	—German, <i>ill.</i>	237
—Liptons	559	—Other cities	443, 444	—Wholesale	237
—Lyons	557, 558	Roasting (geographical)		—Arbuckle's	451, 616
—Oddenino's	558	—Continental Europe	236, 389	—"Aromatic," <i>ill.</i>	610, 613
—Peel's	557	—First	575, 624	—Burns	618
—St. James's	559	—France	389	—Direct flame	606
—Slater's, <i>ill.</i>	558	—Great Britain	389	—Elongated flame	608
—Temple Bar, <i>ill.</i>	558	—Turkey	546	—First patent	595; <i>ill.</i> 596
—Trocadero	558	—United States	389, 589, 591, 642	—Gas sample	606
—Trust-houses, Ltd.	558	Roasting		—Independent cylinders	608
—Ye Mecca Co., <i>ill.</i>	556	—Changes during	653	—Recirculated heat	609
—New York	571, 572	—Chemistry of	295	—Special gas	606
—Dorlon's	571	Roasting, household	576, 577	—Carter Pull-out	427, 431; <i>ill.</i> 588; 589, 608
Restrepo, Dr., <i>q.</i>	316	—Braziers	575	—Combinator	605
Restriction		—Clay dishes	575	—Comet	599
—Exports	461	—Corn-poppers	596	—"Corona," <i>ill.</i>	239
—Planting	460, 461, 503	—Cylinder	102, 576, 577	—Cylinder	593
Retail stores		—Decline of	596	—Dakin, <i>ill.</i>	591, 592
—Austria, <i>ill.</i>	385	—Devices	576, 625	—Delphine tubular, <i>ill.</i>	587, 601
—France, <i>ill.</i>	382	—Dippers and spiders	576	—Evans cylindrical	584; <i>ill.</i> 586
—Spain, <i>ill.</i>	394	—Earthenware dishes	579, 624, 641	—Faulder	238, 604
—United States, <i>ill.</i>	382, 386, 391, 392, 393	—First	575; <i>ill.</i> 576	—First British patent, <i>ill.</i>	586
—Model c. departments	390-392	—France	561, 562	—Fleury & Barker	599, 604
Retailing	382-397	—Glass flasks	583	—Fraser's central heated	606
—Blending	388	—Italian wrought iron, <i>ill.</i>	717, 718	—Fullard's heated fresh air	608
—Channels of distribution	383	—Pans, <i>ill.</i>	577	—Globular	239; <i>ill.</i> 601
—Coffee departments	390-392	—Plates	575; <i>ill.</i> 576	—Gothot Ideal-Rapid, <i>ill.</i>	240, 601
—Credits	397	—Skillets	102	—Hamsley direct-flame	606
—Recent trends	397	—Stirrers, <i>ill.</i>	577	—Henneman	242, 601, 604, 605
Reuter-Jones Mfg. Co.	617	Roasting machines, <i>ill.</i>	234-236, 244	—Hungerford patent	610
Revere, Paul	106, 726, 729-731	—Accessories, <i>ill.</i>	244	—Hyde combined	594; <i>ill.</i> 595
"Revere" chromium drip c.-pot.	633	—Exports from Gt. Britain	585	—"Jubilee"	243, 607; <i>ill.</i> 610, 619
Revett, William, <i>q.</i>	266	—First gas	604	—"Jubilee-Premix"	245, 247
Revista Cafetera	167	—French		—Jumbo	616
Revolution		—Early, <i>ill.</i>	587	—Knickerbocker	599, 611, 612
—American	106, 121	—Glass cylinder	613	—Kuchelmeister drum	616
—French	27, 91, 97	—Gas	604-609	—Lambert	
Revolution, coffee and	15	—German	599	—Gas, <i>ill.</i>	609, 615
Reynolds, J. B.	441	—First	599	—Indirect flame	606, 615
Reynolds, Sir Joshua	77, 84	—Great Britain	238	—Self-contained	614
Reynolds, Hatcher & Pierce	445	—Household		—Steam condenser	613
Rhazes	7, 8, 11, 21, 469, 660	—American		—"Magic," <i>ill.</i>	611, 613
Rhodes, Benjamin	412	—Early	579; <i>ill.</i> 581, 589, 590	—Marchand ball	603
Ricc, W. S.	437	—Later	613, 615	—Martin's	603
Richards, Charles	444	—British, early, <i>ill.</i>	590	—Meade's multiple cylinder	620
Richardson & Lane	436	—Bernard's cylinder	585; <i>ill.</i> 587	—Meteor	599; <i>ill.</i> 601
Richelieu, Duke of	93	—Bijou	613	—Moderne	613
Richheimer, I. D.	465, 618, 619, 621, 622	—Bull's Coal	579	—"Monitor"	242, 243; <i>ill.</i> 248; 404, 606
Ricker, Harvey	612	—Elford's white iron	576	—Morewood	238, 606; <i>ill.</i> 609
Ricks & Co., A. C.	425	—Gee's	593	—Mottant	605; <i>ill.</i> 606, 613
Ridenour, Baker Grocery Co.	439	—Globular, <i>ill.</i>	592, 599, 601	—Muhlberg patents	599
Riggs, J. H.	444	—Gothot's hand	601	—Otto spiral-tubular	605
Riley, James Whitcomb, <i>q.</i>	671	—"Home," glass	613	—Page Pull-out	598
Rinehart & Stevens	443	—Hyde's combined	590	—Pearson patents	599, 604
Rings, coffee bag	622, 653	—Ittel's glass sphere	603	—Perfekt, <i>ill.</i>	599, 601
Rios c.	127, 198, 200; <i>ill.</i> 201	—Kuhlmeir's electric	617	—Postular gas, <i>ill.</i>	587, 605
Ripening season	142	—Lacoux's combined	585	—Potter direct-flame	242, 606
Riple, D. C.	433	—Lauzaune's cylinder	585	—Probat, <i>ill.</i>	238, 599, 601
Risk and Risk Bearing, <i>q.</i>	363	—Lauzaune's "rocking"	603	—Rekord (quick gas)	605
Risley, Christopher	415	—Lawton's	619	—Resson	613
Risley, Leander S.	415	—Porcelain	585	—Schmidt patent	617
Risley & Co., C.	403, 415, 455	—Preterre's weighing	593	—Schnuck gas	620
Rittenhouse, John	585	—Quelle's electric	617	—Shortt electric	616
Ritz, Mons.	560	—Ransom's	585	—Simplex	238; <i>ill.</i> 611
Rivarol	95	—Remington's wheel of buckets, <i>ill.</i>	592	—Sirocco, <i>ill.</i>	607, 613
Rivers	311, 312	—Savo	590, 615	—Thermallo, <i>ill.</i>	243, 244, 245, 247, 612
Roasters		—Schick's patent	583	—Thurmer quick-gas	605; <i>ill.</i> 608
—Advertising expenditures	494	—Silver and gold	578, 590	—Tornado quick-gas	605
—Baltimore	443	—Stillman's	585; <i>ill.</i> 590	—Typholme	238, 242, 604, 605
—Boston	436	—Williamson's	584	—Two-drum, <i>ill.</i>	239, 240
—Chicago	437	—Wood's spherical	590, 593, 642	—Typhoon	599
—Cincinnati	439	—Retail	389, 390	—Van den Brouck cylinder	613
		—Burns, <i>ill.</i>	389	—Van Gölpen	599
		—Electric, early, <i>ill.</i>	615		

# INDEX

813

	PAGE		PAGE		PAGE
Roasting Mach's (Wholesale) ( <i>cont'd</i> )		Rothschilds	459, 460	Saxon Coffee Co.	443
— von Gimborn gas	601	Roubiliac	80	Schadheli, Sheik	9, 266
Roasting methods		Rouch	581, 628	Schaefer, Klausmann Co.	425
— Burns, A. L.; views on	247, 597	Roundy, J. A.	442	Schams, Franz	44, 708
— Charcoal	576	Roundy, Peckham & Dexter Co.	442	Schanne, Alexandre, q.	97
— Coal	242	Roure	604	Scharf, q.	122
— First use	579	Rousseau, Baron Antoine, q.	538	Schemsi	16
— Coke	239, 242	Rousseau, Jean Baptiste	83, 99, 674	Scheuzer, J. J., q.	9, 12
— Crude oil	239	Rousseau, Jean Jacques	91, 93, 98, 686	Schnick, Anthony	583
— Direct-flame	242, 605	Routh, Harold, q.	681	Schilling, A.	432, 441
— Electricity	239, 242, 243, 389, 616	Rowland, Helen, q.	673	Schilling, Rudolf	441
— England	556	Rowland & Humphreys	403, 417	Schilling & Co., A.	441
— France	561	Rowland, Humphreys & Co.	416	Schmelzel, James H.	429
— Gas	239, 242	Rowland, Terry & Humphreys	417	Schmidt, C.	709
— Giacomin process	617	Rowlandson, Thomas	711, 712	Schmidt, Ludwig	617
— Hand	598	Rowley, Levi	429, 434	Schmidt & Ryan	425
— Horse power	598	Royal Electric Fixture Corp.	235	Schmidt & Ziegler	421
— Inner-heating	607	"Royal Granite" c-pot.	633	Schmiedeburg, Dr. Oswald, q.	311
— Natural gas	242, 606	"Royal Rochester" chromium per- colator	633	Schnuck, Edward F.	620
— Single layer	622	Royal Scarlet (brand)	479	Schnull & Krag	444
— Quick vs. slow	605	Royal Scarlet Stores, <i>ill.</i>	386	Schonbrunn & Co., S. A.	431
— Steam power	596, 598	Royal Society	37	School, coffee farm, <i>ill.</i>	167
Roasting plants, <i>ill.</i>	234-236, 244, 261	Rubia Mills	431	Schools, Information for	483
— British, <i>ill.</i>	609	Ruffio, P. A.	709, 711	Schotten, Christian	438
— First in U. S.	400	Ruffner, W. R.	418, 465	Schotten, Hubertus	438
— Eppens-Smith Co., <i>ill.</i>	612	Rule & Bro., Robert J.	436	Schotten, Julius J.	405, 406, 432, 438; q. 591, 592
Roasting trade		Ruliff, Clark & Co.	440	Schotten, William	432, 438, 589
— Great Britain	235	Rumford, Count.	581, 582, 627; q. 628	Schotten & Co., Wm.	438
— United States		Rumsey, Walter, q.	53	Schotten Coffee Co., Wm.	438
— Beginning of	426	Runkle & Co., J. C.	415, 417	Schramm, Arnold	412
— Retail	234	Russell, Edward C.	429	Schroeder, Bruno	460, 461
— New York, early	596	Russell, Frank C.	434, 493	Schroeder & Co., J. Henry	460, 461
Roasts		Russell, James C.	413, 414	Schuler, John G.	444
— Brazilian preferences	573	Russell, Robert	417	Schultz & Ruckgaber	417
— British preferences	556	Russell, Robert S.	434	<i>Schumaniana c.</i>	283
— French preferences	561	Russell & Co.	417, 425, 429, 434	Schumberg, q.	311
— Greek preferences	567	Russell & Fessenden	436	Schwarzer kaffee	555
— Italian preferences	568	Rust-Parker Co.	439	Scialdi	10
— Sample	252	Ruth, Sylvester	443	Scientific opinions	314-320
Robeson-Rochester Corp.	621	Rutter & Co., Thomas	416	Sclerenchyma, <i>ill.</i>	288, 290
Robespierre	91, 93, 98	Ryan & Co., James	441	Scofield c-pot, <i>ill.</i>	720
Robinson, Dr., q.	308			Scofield, Henry	603
Robinson, Edward Forbes, q.	7, 103			Scott, Andrew, q.	81
Robinson & Co., N.	436			Scott, Edwin	435
Robusta c.	198; <i>ill.</i> 279			Scott, Hugh L.	686
— Blends, use in	251			Scott, William	415
— Botanical description	281			Scott & Dash	414
— Ceylon	173			Scott & Meiser	414
— Cup-tests	282			Scott & Sons, William	415
— India	194			Scott, Dash & Co.	414
— Java	127; <i>ill.</i> 187			Scott, Meiser & Co.	414
— Madagascar	183			Scott's Sons & Co., William	415
— Netherlands Indies	188, 209			Scotty, C. (chef)	572
— New York rulings	370			Scriba, Schroppel & Starmer	411
— Tobago	195			<i>Scribner's Magazine, q.</i>	550
— Trinidad	195			Scull, Wm. C.	445
— Uganda	196			Scull, William S.	445
— Varieties	282, 283			Scull Co., William S.	444, 445
<i>Robusta x Maragogipe</i>	283			Sculpture, coffee in	717
Rodney, William	122			Seal (brand)	472, 478
Roe, Sir T., q.	266			Seeds	135, 275, 277
Roettier, John	59			— Ash of	292
Rogers, <i>chk.</i>	117			— Germination, <i>ill.</i>	271
Rolamb, Nicholas, q.	19			Seelye, Frank R.	405, 407
<i>Romance of the Bourbon Chateaus, q.</i>	683			Seeman, Carl	435
<i>Romance of Trade, q.</i>	51			Seeman, Frederick R.	435
Romero, q.	135			Seeman, Joseph	435
Romero, Louis Angel	620			Seeman, Sigel	435
Ronan, James	444			Seeman Bros.	386, 435
Roome, Luke	114			Seeman Bros. & Doremus	435
Roome, William P.	414, 434			Sehon, Stevenson & Co.	446
Roome & Co., William P.	414, 434			Seifert, q.	311
Rooney, John	411			Selby, Thomas	108
Roosevelt, Col.	571			Selden, David	585
Ropes, Joseph	400			Seligsberg, Louis	403, 414
Ropes, Ripley	417			Selim I.	14, 15, 45
<i>Rosary, The, q.</i>	683			Selling ( <i>see</i> Buying and selling green coffee)	
Rosebault, Charles J., q.	555			Selling chart	373
Roseburg, William	451			Sené	582, 629
Rosée, Pasqua	38, 39, 49, 51, 469, 494, 495, 663			<i>Sense of Taste, The, q.</i>	657
— Handbill, <i>ill.</i>	50			Separating	165
Roselius, Henry	620			Separating machinery	147, 237
Roselius, Ludwig	405			— Burn's pneumatic	608
Rosenthal & Sons, A.	425			— Caracolillo, <i>ill.</i>	600
Rosseter, J. H.	424			— Engelberg, <i>ill.</i>	600
Rossi, q.	311			— Eureka, <i>ill.</i>	600
Rossignon, q.	141, 640			— Granada, <i>ill.</i>	593
Rossini	99			— McKinnon, <i>ill.</i>	602
Ro-Tap	650			— Squier	603
Rota	55			Sephton, Geoffrey, q.	671
Rotary analyzer	650			Service, Coffee	27

## S

	PAGE		PAGE		PAGE
Service, coffee (American)		Ships		Smith, Robert A.	437
—Modern, <i>ill.</i>	656	—Barquisimento	204	Smith, Dr. S. Calvin, <i>q.</i>	320
—Porcelain pottery	731	—Caixas	344	Smith, Sydney, <i>q.</i>	686
—Silver, <i>ill.</i>	728	—Gaa Paa	345, 623	Smith, Traver	409, 436
—Twentieth century, <i>ill.</i>	730	—Goed Vrouw	347	Smith, Walter M.	438
—Artistic and historic	719-732	—Marquis de Someruelas	401	Smith, Wm.	442
—Britannia ware, etc., <i>ill.</i>	103, 105, 570, 579, 731	—Mayflower	101, 576	Smith, William F.	437
—Chinese porcelain	723	—Mortar and pestle, <i>ill.</i>	104, 576	Smith, William V. R.	452, 453
—Clay bowls, first	575	—Minerva	124	Smith & Co., D.	411
—Elers ware, <i>ill.</i>	722	—Nancy	116	Smith & Curtis	442
—Ewers	575, 580, 721, 723	—Otter	123	Smith & McKenna	440
—Folkingham pot, <i>ill.</i>	719	—Padang	347	Smith & Son, Thomas	601, 629
—German, <i>ill.</i>	724	—Recovery	400	Smith & Walbridge	416
—Gold	579, 718	Ship fillings	351	Smith Bros.	421
—Italian capodimonte, <i>ill.</i>	724	Shipping coffee		Smith Bros. & Co.	440
—Lantern-shaped <i>c.</i> -pots	579; <i>ill.</i> 719, 721	—Brazil	323	Smith Bros. Brokerage Co.	426
—Leeds, <i>ill.</i>	722	—Colombia	165-166, 335-340	Smith, Roundy & Co.	442
—Pewter pots	576; <i>ill.</i> 638, 639, 731	—Ethiopia	342	Smith's Sons, M. V. R.	416
—Porcelain	579; <i>ill.</i> 722, 724	—Santos	325-335	Smith's Sons, Robert	437
—Pottery, <i>ill.</i>	722	—Venezuela	340	Smollett	678
—Salt glaze, <i>ill.</i>	722, 727	—Arabia	342	Smout, Jules	147, 604
—Seventeenth Century, <i>ill.</i>	718	Shope, W. C.	437	Smuggling	
—Sèvres <i>c.</i> -pots, <i>ill.</i>	724	Shortt, Everett T.	616	—American Colonies	102
—Sheffield-plate <i>c.</i> -pots, <i>ill.</i>	726, 727	Shrinkage		—Sweden	40
—Silex, <i>ill.</i>	572	—Table (green <i>c.</i> )	246	Smyser, Henry L.	452
—Silver <i>c.</i> -pots	573, 579, 656, <i>ill.</i> 720, 723, 725, 727	Sias, Charles D.	436	Snider, H. H.	415
—Sino-Lowestoft <i>c.</i> -pot, <i>ill.</i>	724	Siciliano, Count Alexandre	333	Sobieranski, <i>q.</i>	311
—Staffordshire ware, <i>ill.</i>	722	Siddons, Mrs.	689	Sobieski, King John	45, 46
—Stone ware, <i>ill.</i>	722, 727	Siegfried, John C.	441	Sociedade Promotora da Defesa do Café	489
—Brazil, <i>ill.</i>	573	Siegfried & Brandenstein	441	Sociedade Rural Brasileira	159
—French		Siegman, John G.	443	Société des Plantations d'Abys-	
—Silver, <i>ill.</i>	729	Sielcken, Hermann	333, 405, 406, 412, 417, 442, 447-451, 452, 458-461	sinia	170
—Glasses	538	Sieling, Edw.	622	Société Generale	460, 461
—London cafes and restaurants	55-57	Sierra Oaxaca <i>c.</i>	202	Soil	
—Oriental <i>c.</i> -pots	579	Signs, Coffee-house		—Best	134, 136
—N. Y. hotels	572	—London		—Brazil	134, 153
—Persia, <i>ill.</i>	544, 546	—Bowman's	49, 51	—Colombia	162
—Spanish, <i>ill.</i>	727	—Morat	59, 700	—Java	134
—Turkish	577; <i>ill.</i> 731	—Rose's	51	—Kenya	182
—Street, <i>ill.</i>	549	—Soliman	59	—Venezuela	197
—Vienna, <i>ill.</i>	727	—New York	113	Soliman Aga	29, 87, 88
Servico Technico do Café	159	—King's Arms	120	Soliman the Great	14, 16
Sethness	299	Signs, Grocers'		Soluble coffee	258-261, 465-466, 621, 651
Seven Day (brand)	453	—Lowell, Ebenezer	399	—History of	465
Sèvres <i>c.</i> -pots, <i>ill.</i>	724	—Richards, Smith	120	—Kato's patent	404
Seymour, Mark T.	617	—Webster, George	120	—Machinery	260
Shade, <i>c.</i> -growing under	136	Silex <i>c.</i> maker	633; <i>ill.</i> 634, 635	—Processes	259
—Colombia, <i>ill.</i>	137, 160; 163	Silex Co.	621, 622	—U. S. Army war needs	466
—Kenya, <i>ill.</i>	181	Silver <i>c.</i> -pots ( <i>see</i> Service)		—Washington's patent	404
—Puerto Rico, <i>ill.</i>	192	Silver skin	142, 275, 289	Soluble Coffee Co. of America	466
Shadli, Shaomer ( <i>see</i> Schadel)		Silversmiths		Somers, A. L.	443
Shapleigh Coffee Co.	436	—American	730, 731	Song, coffee in	675, 712, 715, 717
Shaw, Daniel A.	416	—Colonial	729	Song of the Coffee Bird	485
Shaw, John N.	621	—French	718	<i>Songs of Brittany</i>	667
Shaw, John W.	427	Simmonds, H.	413, 414	Sorenson, John S.	450
Shaw, William	728	Simmonds, W. Lee	417	Sorenson & Nielson	417, 450
Shaw & Priest's <i>c.</i> -pot <i>ill.</i>	727	Simmonds & Bayne	414	Sorley, William	416, 426
Shaw's Louisiana Coffee and Spice Mills	440	Simmonds & Co., H.	414	Sorting	
Sheaff, Henry	411	Simmonds & Newton	414	—Hand	147; <i>ill.</i> 165, 343
Shear Coffee Co.	446	Sinclair, Evans & Elliot	444	Sorting machinery	147-148
Sheffield plate <i>c.</i> -pots, <i>ill.</i>	726, 727	Singleton, Esther, <i>q.</i>	101, 111, 642	Sorver, McEvoy & Co.	425, 437
Sheldon, Henry	415	Sinnot, J. B.	432, 440	Soulie	98
Sheldon & Co., Henry	414, 415	Sino-Lowestoft <i>c.</i> -pot, <i>ill.</i>	724	Southern Coffee Mills, Inc.	440
Sheldon, Banks & Co.	403, 415	Sirups ( <i>see</i> Syrups)		Southern Coffee Polishing Mills	440
Shemsi	551	Sizing	147	Southern Indian <i>c.</i>	128, 129
Shepherd, T. H.	76, 80, 81, 711	Skiddy, Francis	415	Southern Pacific Co.	424
Sheppard, Alexander	437	Skiddy, Minford & Co.	415, 457	Southey, Robert	151
Sheppard & Sons, Inc., Alex.	437	Skinker, G. M.	409	Souvestre, Emile, <i>q.</i>	684
Sheridan, Richard Brinsley	75, 76	Slack bags	351	"Speakeasies," coffee	16
Sherif-Eddin-Omar-ben-Faredh	663	Slacks	349	<i>Spectator</i>	71, 76, 81, 82, 678, 679
Sherley, Sir Anthony	31	Slaughter, Thomas	80	Spermodern ( <i>see</i> silver skin)	
Sherman, Fred	442	Slave auctions, Phila., <i>ill.</i>	124	<i>Spice Mill, q.</i>	452, 454
Sherman, Fred T.	413, 417	Slemmons & Conkling	444	<i>Spice-Mill Companion</i>	454
Sherman, Henry B.	442	Sloane, Sir Hans	82	Spices in <i>c.</i>	642
Sherman, Lewis	406, 408, 442	Sloss, Robert, <i>q.</i>	459	Splitting nickels	396
Sherman, S. S.	441, 442	Sloss Perfect Coffee Makers Inc.	621	Spot brokers	367
Sherman, William	441	Slow roast	605	—Santos	327
Sherman, William H.	442	Small, C. K.	413, 416	Spot of leaf and fruit ( <i>see</i> Diseases)	
Sherman, William M.	442	Small, John	416	Spot Market, New York	357, 362
Sherman, William T. (Gen.) <i>q.</i>	682	Small Bros. & Co.	413, 415, 416	Spot quotation committee (N. Y. Exch.)	365
Sherman & Taylor	413	Smalls & Bacon	416	Spout, non-drizzle	621
Sherman Bros. & Co.	437, 442	Smart, Joseph F.	620	Sprague, Albert A.	430, 437
Shevaroy C.	128, 206	Smith, Adam	77	Sprague, Irvin A.	412
Shewbert, John	122	Smith, Clarence	416	Sprague, O. S. A.	437
Shields & Boucher	443	Smith, Daniel	125	Sprague & Rhodes	412, 425
Shihab-ad-Din manuscript	662	Smith, Frank	434	Sprague & Stetson	437
Shipping Board, U. S.	463	Smith, George H.	437	Sprague, Warner & Co.	437
		Smith, John (Capt.)	33, 101	Sprague, Warner & Griswold	437
		Smith, John Thomas	689	Spray Coffee & Spice Co.	393
		Smith, L. B.	428		
		Smith, Michael E.	432, 437		
		Smith, Robert	437		

# INDEX

815

	PAGE		PAGE
Spraying against pests .....	194	Story, Rufus G. ....	415, 431
Spruce, Richard, <i>q.</i> .....	135	Story & Co., R. G. ....	431
Squier, George L. ....	594	Story-Tellers in <i>c.</i> houses .....	549, 552
Squier Mfg. Co., Geo. L. ....	592-594, 603	Stouts, Joseph .....	708
St. Germain's Fair .....	579	Stowe, Orson W. ....	610
St. Serf, Thomas, <i>q.</i> .....	674	Strassberger, L. ....	617
Stachan, John .....	115	Straus, Oscar .....	555
Staleness .....	300, 373, 377, 378	Strauss, Herman M. A. ....	621
Stamp Act .....	116, 121, 124	Strauss & Sons, L. ....	448
Stamps, Trading .....	385	Street brokers .....	367
Standard Brands, Inc. ....	436, 443	Stringer, Mary, <i>chk.</i> .....	52
Stanley, Dr. Leo L., <i>q.</i> .....	319	Strong, Joseph .....	444
Stanton, Sheldon & Co. ....	415	Strongin, Dr. E. I., <i>q.</i> .....	319
Star Coffee and Spice Mills. ....	441	Strowbridge, Turner .....	609
Star Mills .....	429, 434	Stuchell, J. W. ....	443
Starhemberg, Rudiger von .....	45, 46	Stump, Aug. ....	417
State Historical Society of Wisconsin .....	106	Stumpp & Co., August .....	417
State of São Paulo Pure C. Co. Ltd. ....	488	Substitutes .....	70, 258, 494
Statue of Kolschitzky ( <i>see</i> Kolschitzky) .....	117	—Barley .....	42
Steam power for roasting .....	596, 598	—Betony .....	70
Steele, Mrs. ....	422	—Bocket .....	70
Steele, E. L. G. ....	422	—Cereals .....	236, 258, 317, 472
Steele, Sir Richard. 71, 75, 76, 80, 81, 676; <i>q.</i> 678; 690	690	—Chicory .....	42, 236, 258
Steele & Emery .....	444	—Corn .....	42
Steele-Wedeles Co. ....	437, 438	—Figs, dried .....	42, 236, 258
Steeping .....	571, 652	—Germany .....	522, 567
Ste-Foix .....	91, 686	—Malt .....	236
Steinwender, Julius .....	415, 417	—Roumania and Serhia .....	569
Steinwender, Stoffregen & Co. ....	415, 417, 425, 438	—Russia .....	569
Stella (Esther Vanhomrigh) .....	71	—Saloop (sassafras and sugar) ..	70
<i>Stenophylla c.</i> .....	283	—Vegetable .....	258
—Botanical description .....	278	—Wheat .....	42
<i>Stenophylla x Abeokuta</i> .....	283	Succory ( <i>see</i> Chicory) .....	439
<i>Stenophylla Paris c.</i> .....	282	Suess-Opppenheimer, Joseph .....	43
Stephanoderes bean-borer .....	141, 146	Sugar candy in <i>c.</i> ....	626
Stephen, <i>chk.</i> .....	89	Sugar coating .....	237, 239, 567
Stephens, Alvan .....	442	Sugar in <i>c.</i> ....	22, 54, 87, 95, 570
Stephens, Henry A. ....	430, 442, 443	—Brazil .....	573
Stephens, Samuel R. ....	442	—Cairo .....	22, 625
Stephens & Co., A. ....	437	—Greece .....	568
Stephens & Sons, A. ....	442	—North America .....	101
Stephens & Widlar .....	443	—Turkey .....	551, 625
Steppe, J. P. ....	617	—U. S. ....	570, 571, 642
Sterility, Coffee and .....	19, 42, 713	Sugar stick, brown .....	570
Sternau, Sigmund .....	617	Sugar Trust fight .....	452
Sternau & Co., S. ....	617	Sullivan, Luke .....	80
Stetson, Z. B. ....	437	Sully, D. J. ....	404, 458
Stevens, A. A., <i>q.</i> .....	320	Sultan, Café .....	624
Stevens, Alfred .....	99	Sumatras <i>c.</i> ....	129, 209
Stevens, Henry B. ....	603	Surinam <i>c.</i> ....	205
Stevens, W. & S. ....	444	Surrogates ( <i>see</i> substitutes) .....	436
Stevens & Armstrong .....	417	Swain, Earle & Co. ....	723, 727
Stevens, Armstrong & Hartshorn. ....	416	Swaythling, Lord .....	415
Stevens Bros. & Co. ....	417	Swazey, S. L. ....	157
Stewart, C. H., <i>q.</i> .....	204	Sweated coffee .....	344, 345, 369
Stewart, James .....	414	—Artificial (U. S. rulings) ..	344, 345, 369
Stewart, Robert C. ....	413, 417, 433	—Sailing vessels .....	208, 344, 345
Stewart & Ashby Coffee Co. ....	438	Sweeney, John .....	427
Stewart & Co., R. C. ....	413, 425	Swett, E. H. ....	436
Stewart & Walker .....	414	Swift, Jonathan. 71, 75, 80, 84, 676; <i>q.</i> 681; 690	690
Stewart, Carnal Co., Ltd. ....	425	Swift & Co., H. H. ....	417
Stickney & Poor .....	436	<i>Sylva Sylvarum, q.</i> .....	35, 663
Still, Ernest M. ....	621	Syndicates .....	455
Still & Sons, W. M. ....	616	—Arnold-Dash-Kimball .....	455
Stillman, Abel .....	585	—German Trading Co. ....	455
Stillman, F. E. ....	438	Syria, <i>The Holy Land, q.</i> .....	552
Stiner & Co., Joseph .....	435	Syrups, coffee; recipe for .....	658
Stitt, William J. ....	429, 433	Szekacs, <i>q.</i> .....	311
Stitt & Co., W. J. ....	433, 435		<b>T</b>
Stix, Sylvan L. ....	435	Taber & Place .....	431
Stock Exchange, New York .....	119	<i>Table, The</i> .....	558
Stoffregen, Carl H. ....	406, 415, 419, 490	<i>Table Traits, q.</i> .....	639
Stoffregen, Chas. ....	415, 417, 432	Tablet coffee .....	262, 621, 622
Stokes, John .....	125	Tachiras <i>c.</i> ....	128, 204
Stone, Ordean Wells Co. ....	439	Tackaberry, William .....	445
Stoning .....	237	Tackaberry Co., Wm. ....	445
Stoning machinery, <i>ill.</i> .....	245; 247	Taffae & Bellion .....	425
Storage .....	358	Taine .....	98
—Havre, <i>ill.</i> .....	357	Talbot, Winslow & Co. ....	442
—London .....	357	Talbutt, Robert H. ....	616
—New Orleans, <i>ill.</i> .....	352, 353	Talleyrand, Prince .....	99, 685
—New York, <i>ill.</i> .....	346	Tanganyika <i>c.</i> ....	207
—Santos .....	327	Tannin .....	473, 651
<i>Storia di Venezia nella Vita Privata, La., q.</i> .....	23	Tapachula <i>c.</i> ....	201, 202
Storm, Walter .....	417	Tapperi, David, <i>q.</i> .....	7
Storm, Smith & Co. ....	417	<i>Task, The</i> .....	669
		Tattler .....	71, 76, 81, 678
		Tavernier .....	27
		Taverns .....	105
		—Boston .....	107
		—Blue Anchor .....	107, 105
		—Bunch of Grapes .....	104, 105
		—Cole's .....	105, 106; 732
		—Green Dragon .....	105, 106; 732
		—Indian Queen .....	105, 106
		—King's Head .....	105
		—Red Lyon .....	105
		—Ship .....	105
		—Sun .....	105, 106
		—London .....	691
		—George, <i>ill.</i> .....	56
		—Mermaid .....	688, 689
		—Old Cock, <i>ill.</i> .....	688
		—Old Tabard, <i>ill.</i> .....	52
		—Rose .....	695
		—Shakespeare's Head .....	113
		—New York .....	114
		—Atlantic Garden House .....	114
		—Black Horse .....	117
		—Fighting Cocks .....	114
		—Fraunces' .....	113
		—Jamaica Pilot Boat .....	115
		—King's Head .....	121
		—Queen's Head .....	122
		—White Lion .....	126
		—Philadelphia .....	122
		—Blue Anchor .....	125
		—City .....	125
		—Globe .....	125
		—New .....	125
		—Smith's .....	125
		Taxation ( <i>see also</i> Duties; Fines; Licenses; Pure Food, etc.) ..	166
		—Colombia .....	55
		—England (1714) .....	342
		—Ethiopia .....	43
		—Germany .....	193
		—Puerto Rico .....	158
		—São Paulo .....	40
		—Sweden .....	403, 413
		Taylor, James H. ....	411
		Taylor, William .....	413, 415
		Taylor & Co., James H. ....	412
		Taylor & Co., Moses .....	400
		Tea .....	102
		—American colonies .....	400
		—Imports .....	102
		—Introduction .....	102
		—Per capita consumption .....	101
		—Stamp Act increases consumption ..	11
		—Substitutes .....	8
		—Antiquity .....	31
		—Discovery .....	676, 688
		—Early reference .....	557
		—Eulogized by .....	53
		—Johnson, Samuel .....	70
		—Great Britain .....	70
		—First newspaper advertisement ..	55
		—First sold in England .....	57
		—Imports .....	21
		—National beverage .....	676
		—Prices .....	312
		—Sold in coffee houses .....	121
		—Europe (first used) .....	529
		—Literary stimulus .....	521
		—Mental efficiency, Effect on .....	367
		—Philadelphia .....	411
		—United States .....	719
		—Consumption per capita .....	252, 278, 284, 261, 301, 303, 307, 308, 311, 315, 316, 369, 372, 373, 378, 383, 388-391, 396, 407-409, 454, 455, 475, 476, 605, 623, 635, 647, 648, 672
		—Consump. compared with coffee ..	404
		—Laws affecting .....	Tea gardens ( <i>see</i> Gardens)
		—Precedes <i>c.</i> .....	Tea party ( <i>see</i> Boston; New York)
		Tea and coffee pots .....	T'eh (tea) .....
		<i>Tea and Coffee Trade Journal, q.</i> ..	Teixeira, Pedro, <i>q.</i> .....
		252, 278, 284, 261, 301, 303, 307, 308, 311, 315, 316, 369, 372, 373, 378, 383, 388-391, 396, 407-409, 454, 455, 475, 476, 605, 623, 635, 647, 648, 672	Teller Coffee Co. ....
		—Begins publication .....	Teller Brokerage Co. ....
		Tea gardens ( <i>see</i> Gardens)	31
		Tea party ( <i>see</i> Boston; New York)	266
		T'eh (tea) .....	444
		Teixeira, Pedro, <i>q.</i> .....	425
		Teller Coffee Co. ....	
		Teller Brokerage Co. ....	





INDEX

817

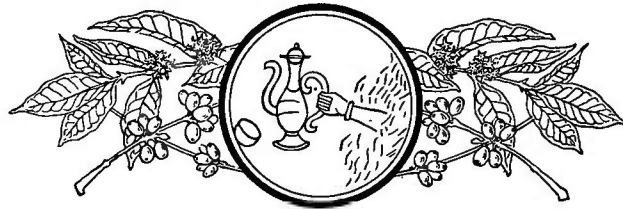
	PAGE
Valorization (Brazil).....	333, 458-462, 526, 527
—Norris, Senator .....	406, 460
—São Paulo .....	158
—Sielcken, H.....	333, 405, 406, 449, 450, 459
—U. S. gov't action.....	406, 460
Van Dam, Anthony .....	411
Van dan Broeck, Pieter .....	39
Van Essen .....	39
Van Etten, E.....	466
Van Gülpen, Alexius.....	447, 454, 455, 594, 599
Van Gülpen & Co.....	599
Van Linschooten, Hans Hugo, q.....	31
Van Loan, Thomas .....	433
Van Loan & Co.....	433
Van Loan, Maguire & Gaffney, .....	433, 435
Van Loo .....	706, 708
Van Ommen, Adrian .....	2, 39
Van Ostade, Adriaen .....	40, 704, 705
Van Outshoorn, Gov.-Gen. Willem .....	2
Van Rooy, Henry .....	426
Van Vliet, C. W.....	593
Van Zandt & Co., M. N.....	444
Vanderhoef, George W.....	415
Vanderhoef & Co., George W.....	415
Vanderweyde, P. H.....	598
Vane, Gov.....	105
Vanessa (see Vanhomrigh)	
Vanhomrigh, Esther .....	681
Vaniere .....	663
Vankorn, Guggenheimer & Co.....	436
Vardy, James .....	585, 629
Variagata c.....	278
Varnar .....	39
Varellman & Co., F. G.....	425
Vassieux, Madame .....	585, 631
Vaughn, V. C., q.....	308
Velloni .....	99
Venard, G.....	441
Venders (see Peddling)	
Venetian Republic, The, q.....	25
Venezuelas c.....	127, 129, 204
Verborg, Henry .....	438
Verdier & Closset .....	443
Verlaine, Paul .....	91
Vernard, G.....	421
Verri, Pietro .....	26
Virtu and use of coffee, q.....	525
Vesling (Veslingius) Johann, q.....	8, 22, 23, 625
Vickers, T. L.....	434
Victoria and Albert Museum (see Art collections)	
Victoria Arduino-Societa Anonima .....	618
Victorias c.....	198, 200
Vie privée d'autrefois, La., q.....	3
Viehoever, A.....	281, 282
Vienna	
—Besieged by Turks .....	45
—Coffee-makers' guild .....	48
Vienna, Relation of the siege of, q.....	47
Villa vicentino, Michael Angel .....	621
Vincent coffee-pot .....	723, 727
Vintshgau .....	312
Virey, q.....	17
Virginia Sweet Foods, Inc.....	445, 446
Vis-a-Vac c. maker .....	633; ill. 634
Viviani, Count, ill.....	77
Vogler, A. J.....	439
Voit, Carl V., q.....	308
Volkman, George .....	441
Volkman, Geo. F.....	441
Volkman, Daniel G.....	441
Volkman, Wm. G.....	441
Vollrath enameled drip c.-pot.....	633
Voltaire.....	89, 91, 93, 674-676, 684, 685
von Gimborn, Carl .....	455
von Gimborn, Theodor.....	447, 454, 455, 599, 601
von Liebig, Baron .....	564
von Mandelsloh, Joh. A., q.....	41
Voyage de l'Arabie Heureuse.....	1, 11, 27; ill. 28, 29; 30, 133, 663
Voyage into the Levant, q.....	35
Vulcaren, John P. A., q.....	47
Vyal, John .....	105

W

Wadhams & Co., Inc.....	443
Wagener Co., F. W.....	446
Wagner Mfg. Co.....	621
Wagon-route distributors (see home-service merchants)	
Wagstaff, David .....	411
Wahibis .....	662
Waite & Sener .....	584, 585
Waite, Creighton & Morrison.....	413
Wakeman, Abram, q.....	403, 407, 413
Walbridge, Augustus .....	416
Walbridge, Inc., Augustus M.....	416
Wales, Henry .....	444
Wales, Nathaniel B.....	622
Walker, D. N.....	493
Walker, John .....	593, 594
Walker, Joshua .....	414
Walker Sons & Co., Ltd.....	594, 603
Wallace, Alexander .....	411
Wallace, Alfred Russel, q.....	135
Wallace, Hugh .....	411
Wallace, John William, q.....	122
Wallace, William, q.....	539
Walle, Friedrich .....	709
Wallen, Geo. S.....	418
Wallen & Co., Geo. S.....	418
Walsh, Rev. Robert, q.....	547
Walton, William .....	411
Wanni Rukula c.....	281
Ward, Ned, q.....	73
Warehousing	
—Barranquilla, ill.....	337
—Havre .....	355
—New York, ill.....	346, 347
—San Francisco .....	423
—Santos .....	327; ill. 328, 329
Warfield, John D.....	438
Warfield, W. S.....	438
Warne, E.....	444
Warner, Alonzo A.....	617
Warner, C. M.....	466
Warner, Ezra J.....	437
Warnier, q.....	651
Warren .....	106
Warren & Bedwell .....	442
Warren & Co.....	417
Wash-brew .....	53
Washed method of preparation, 142, 143; ill.....	144
Washer, ill.....	592, 606
Washing .....	145
—Kenya, ill.....	182
Washing machinery .....	145
Washington, G.....	404, 465
Washington, George (Gen.).....	116, 126, 400, 571
—Official welcome, New York, ill.....	110, 116
Washington, Martha .....	126
Washington Coffee Refining Co., G.....	466
Washington's Instant Coffee, G.....	466
Wastell c.-pot, ill.....	721, 725
Water, effect on brew .....	655
Water solubles .....	623
Waterbury & Force .....	418
Water with coffee .....	540, 568
Watjen, Toel & Co.....	417
Watson, q.....	122
Waygood, Tupholme Co.....	605
Wear, F. F.....	619
Wear, Norman H.....	441
“Wearever” aluminum percolator .....	633
Webb, James R.....	436, 437
Webb, Mary F.....	438
Webb, Rudolphus L.....	610
Webb, Thomas J.....	436, 438
Webb & Son, James R.....	437
Webb, Cheek & Co.....	445
Webb Co., Thomas J.....	438
Webb, Hughes & Co.....	445
Webber, q.....	312
Webster and Parkes .....	638
Webster, Daniel .....	106
Webster Co., E. R.....	445
Wedding Breakfast (brand) .....	479
Wedemeyer, q.....	312
Weideman Co.....	442, 443
Weighing machinery, ill.....	256, 258

	PAGE
Weighing machinery (cont'd)	
—Edtbauer, ill.....	257; 405
—Smyser .....	452
Weikel & Smith .....	437
Weikel & Smith Spice Co.....	437
Weir, J. B.....	434
Weir, Ross W.....	405, 407, 434, 490
Weir & Co., Ross W.....	429, 434, 435
Weir, Inc., Ross W.....	434
Welch; Amos S.....	427
Wells, John .....	417, 621
Wells Bros.....	417
Welsh; Ebenezer .....	429
Wertheimer, Leo .....	621
Wessels & Bros., C.....	417
Wessels, Kulenkampf & Co.....	417
Westcott, q.....	122
Western Electric Co.....	620
Western Grocer Co.....	446
Westfal, J. R.....	431
Westfeldt, Geo.....	415
Westfeldt, Geo. G.....	409
Westfeldt Bros.....	421, 425
Weston & Grey .....	417
Wet method of preparation.....	142-144, 157, 164
—Brazil .....	157
—Colombia .....	164
Wetherill, Charles M., q.....	644
Wetzelberger, L. A.....	424
Weyl & Co., G.....	417
Weyl & Norton .....	417
Wheeler & Co., Ezra .....	403, 416
Whipped cream in c.....	555, 568, 569
Whistling tea or c.-pot.....	621
White coffee .....	557
White, A. E.....	618
White, Francis .....	83
White, Herman M.....	585
White, Peregrine .....	576
White, T. C.....	440
White House (brand) .....	478
White Rose (brand).....	435, 478; ill. 482
Whiting & Taylor .....	437
Whiting, Goebel & Co.....	437
Whitmarsh, Theodore F.....	463
Whitmee Engineering Co.....	238, 604-606
Wholesale Grocers Corp.....	437
Wholesale merchandising of coffee .....	371-381
Wholesaling roasted coffee.....	233, 234, 371-381
Wholesome advice against the abuse of hot liquors, q.....	54
Wickersham, Attorney General .....	460, 461
Widlar, Francis .....	430, 443
Widlar & Co., F.....	443
Wiji Kawih .....	7
Wilcox, Albert C.....	622
Wilcox Co., F. D.....	425
Wild (see Flavors)	
Wild, James .....	427
Wilde, Herbert W.....	427
Wilde, John .....	427
Wilde, Joseph .....	427
Wilde, Samuel .....	417, 427, 428
Wilde & Sons, Samuel .....	427
Wilde's Sons Co., Samuel.....	429, 435
Wilder, Harold K.....	622
Wiley, Harvey W., q.....	307
Wilhelm, R. C.....	246
Wilkins Co., John H.....	446
Willcox, O. W., q.....	284
Wille, Theodor .....	460, 461
William III.....	84
Williams, Frank .....	413, 417, 434
Williams, William M.....	621
Williams & Co., R. C.....	386, 427
Williams & Co., R. S.....	427
Williams & Potter .....	427
Williams & Tait .....	442
Williams, Cbapin & Russell .....	413
Williams, Russell & Co.....	413, 463
Williamson, C. G., q.....	59
Williamson, Peregrine .....	584
Williamson, S. H.....	434
Williamson, W. F.....	409
Willis, Thomas, q.....	54
Willison, Walter W.....	621
Wills & Co., Alexander .....	444

	PAGE		PAGE		PAGE
Wilshire, Jos. ....	436	Woolson, A. M. ....	430, 442, 452	Yantz & Howes .....	439
Wilson, Increase .....	584	Woolson Spice Co. ....	439, 442, 450, 452	Yauca c. ....	205
Wilson, Woodrow .....	462, 463	World War effects .....		Ye Mecca Co. ....	557
Wilson & Bowers .....	416	—Consumption .....	519	Yemen c. ....	206
Wilson & Co., J. W. ....	416	—Costa Rica .....	508	Yield .....	139, 277
Windbreaks .....	136	—United States trade ..	407, 448, 462	—Abyssinia .....	169
Window-displays, <i>ill.</i> ..	385, 386; 394-396, 484, 487, 489	—New Orleans .....	419	—Guatemala .....	177
Wine .....		—San Francisco .....	419	—Hawaii .....	180
—Aromatic .....	624	<i>World's Commercial Products, The, q.</i> .....	271	—India, Southern .....	194
—Coffee classed as .....	13; 16, 623	World's teacup and world's largest ship, <i>ill.</i> .....	501	—Mexico .....	187
—Coffee a substitute for .....	11	<i>World's Work, q.</i> .....	459	—Nicaragua .....	189
—Made from fruit .....	11	Worth, J. G. ....	435	—Record .....	499
—Made from hulls and pulp ..	624	Wright, George C. ....	430, 436	—Venezuela .....	197
Wing Bros. & Hart .....	433	Wright, George S. ....	436; q.	Yonker, Edw. G. ....	409
Winsor, Dr. A. L., <i>q.</i> .....	319	Wright, Geo. W. ....	429	Young, Arthur, <i>q.</i> .....	97
Winter & Smilie .....	417	Wright, John S. ....	417, 426	Young, D. K. ....	417
Winthrop, Gov. ....	105	Wright & Co., J. T. ....	422	Young, Samuel .....	430, 443
Wise, Capt. ....	124	Wright, Hard & Co. ....	417	Young, Mahood & Co. ....	443
Witherspoon, John .....	406	Wrightsville Hardware Co. ....	609	Youngs & Amman .....	412
Withington, Elijah .....	427, 428	Wroth, Warwick, <i>q.</i> .....	78	Yuban (brand) .....	379, 453
Withington & Pine .....	427	Wurfbain .....	39	Yuban advertising .....	477, 478
Withington & Wilde .....	427	Württemberg, Duke of .....	43	Yuengling, D. G. ....	444
Withington, Francis & Welch ..	427	Wyatt, Charles .....	581, 629	Yunga c. ....	205
Withington, Wilde & Welch ..	429	Wyld, F. Lehnhoff .....	466		
Witsen, Nicolaas .....	2, 39	Wyman, Clark E. ....	440	<b>Z</b>	
Wolcott, Frank E. ....	622			Zander & Co., Inc. ....	425
Wolf & Seligsberg .....	413	<b>X</b>		Zecchini, G. B. ....	669
Wolseley, Viscountess .....	720, 727	XXXX (brand) .....	478	Ziegler Arctic expedition .....	465
<i>Women's petition against coffee, The</i> .....	66	Xanthin .....	296	Zilmore & Co., A. G. ....	444
Women as coffee sellers .....	52			Zinsmeister, Sr., Frank .....	440
Wood, Dr. ....	308	<b>Y</b>		Zinsmeister, Jacob .....	432, 440
Wood, Irving W. ....	622	Yaffey c. ....	206	Zinsmeister & Son, Frank .....	440
Wood, Jarvis A., <i>q.</i> .....	469	Yates & Dudley .....	444	Zinsmeister & Sons, J. ....	440
Wood, Thomas R. ....	593			Zola, Emile .....	98
Wood & Co., I. A. ....	426			Zoller & Little .....	443
Wood & Co., Thomas .....	436			Zwaardcroon, Henrious .....	2, 187
Woodbead, Horace G. ....	622			Zwick, Charles .....	441
Woods, Ehrhard & Co. ....	425				
Woodward, Elizabeth .....	622				

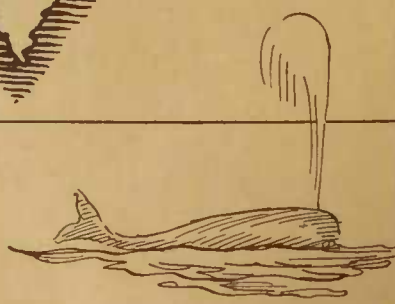




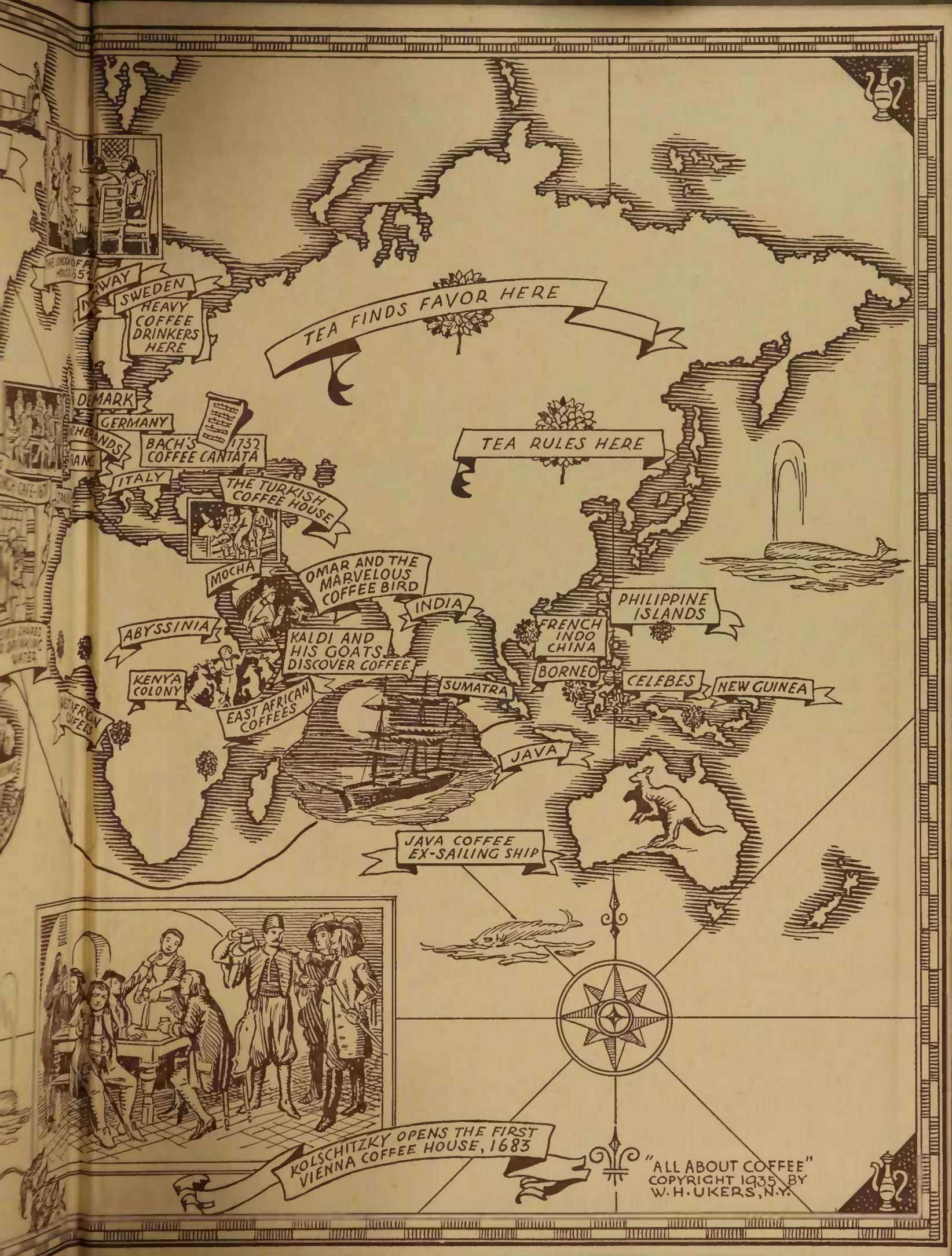




**PICTURE  
COFFEE  
MAP  
of the  
WORLD**







SWEDEN  
HEAVY  
COFFEE  
DRINKERS  
HERE

TEA FINDS FAVOR HERE

TEA RULES HERE

DENMARK

GERMANY

BACH'S  
COFFEE CANTATA  
1732

NETHERLANDS

ITALY

THE TURKISH  
COFFEE HOUSE

MOCHA

OMAR AND THE  
MARVELOUS  
COFFEE BIRD

INDIA

PHILIPPINE  
ISLANDS

ABYSSINIA

KALDI AND  
HIS GOATS  
DISCOVER COFFEE

FRENCH  
INDO  
CHINA

KENYA  
COLONY

EAST AFRICAN  
COFFEES

SUMATRA

BORNEO

CELEBES

NEW GUINEA

JAVA

JAVA COFFEE  
EX-SAILING SHIP



KOLSCHITZKY OPENS THE FIRST  
VIENNA COFFEE HOUSE, 1683



"ALL ABOUT COFFEE"  
COPYRIGHT 1935 BY  
W. H. UKERS, N.Y.



